

Premium Wood Swinging Patio Doors

Interior & Exterior Options



A MULTITUDE OF OPTIONS IN A SINGLE PATIO DOOR SYSTEM



JELD-WEN® Premium Wood swinging patio doors are the latest innovation among a new generation of patio door systems. After countless hours of research and development, we created a patio door system that offers over 300 configurations, generates incredible performance ratings and delivers contemporary styling to accommodate any design preference. We have consolidated the finest features of our Tradition Plus™ and Sitaline EX™ brands to afford you with the peace of mind that you are receiving nothing but the best when you purchase our Premium Wood swinging patio door. This patio door is an excellent choice for new construction or remodeling projects, as it fits nicely with our current selection of windows. Our product development process will continue throughout 2015 with additional iterations and enhancements being added to the offering.



Auralast® Wood protects against wood rot for as long as you own and occupy your home. Guaranteed.



Guaranteed Protection Against Wood Rot

JELD-WEN® wood windows and patio

doors made with exclusive pine Auralast Wood are guaranteed not to rot for as long as you own and occupy your home. Wood components made from Auralast Wood maintain their structural integrity even in the toughest climates. Visit jeld-wen.com to view the full warranty.*



Surface-to-Core Protection

Because of our vacuum/pressure process, Auralast Wood provides virtually

100% penetration of the protective ingredients. Other manufacturers use submersion/dip-treatment methods, which only protect the outer surface of the wood.



Working With Auralast Wood is Easy

Auralast offers the strength and beauty

of real wood because it is real wood, not a composite. Auralast Wood is colorless, stainable and odorless.

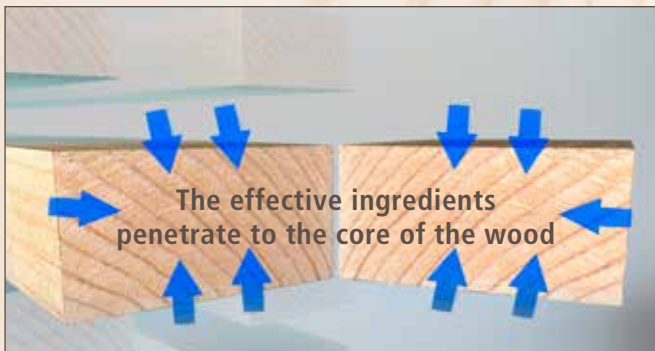

Virtually 100% Surface-to-Core Protection



Auralast is Safe

Auralast Wood is made by using a water-based solution to deliver the effective ingredients to the core of the wood. Traditional dip-treatments use a solvent-based chemical bath. During production our Auralast process releases 96% fewer volatile organic compounds than the traditional dip-treatment method.



Traditional treatments only protect the outer surface

A JELD-WEN Exclusive

Only JELD-WEN makes window and door products with natural pine Auralast Wood that are built to last.

Protects Against Water Saturation

Auralast Wood offers superior resistance to water saturation, which protects against swelling that causes windows and doors to stick.

Protects Against Termites

Harmful termites will eat through unprotected wood—not so with Auralast Wood.

Visit jeld-wen.com/auralast for more information

***Auralast Lifetime Limited Warranty Coverage for Wood Decay and Termite Damage**

JELD-WEN products made from pine Auralast Wood will not rot.

FORM & FUNCTION

When it comes to indoor-outdoor living, the right patio door makes a major impact. Homeowners want it all: top quality, beautiful style, energy efficiency and reliability in any weather. The Premium Wood swinging patio door can be configured into over 300 designs by selecting between operating and stationary sidelites, transoms or raised panels. The images below are a small sampling of what we can fashion for your home.

Configurations



4-Panel (interior view)



2-Panel with Transoms (interior view)



2-Panel with Venting Sidelites (interior view)

Redesigned Sill, Frame & Weather-Strip System

We have completely redesigned the sill, frame and weather-strip systems. The new high performance and energy efficient fiberglass sill allows water to drain away from the door, but also prevents high winds and rain from entering. This feature, along with silicone injected corner keys and a double weather-strip system, contribute to its enhanced air and water infiltration performance. Sills can be designed at PG 35 (standard), PG 50, or ADA ratings.

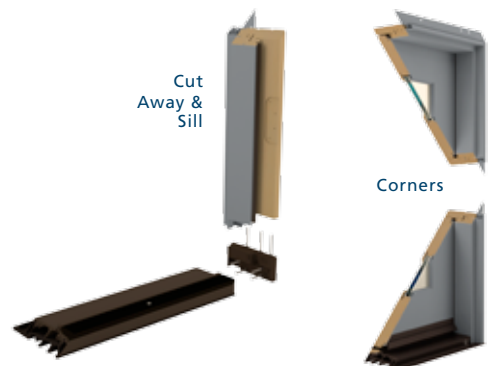

Optional ADA-compliant sill for wheelchair accessibility on out-swinging patio doors only.

Check with your local JELD-WEN representative for specific sizes.



INTERIOR OPTIONS

Interior Wood Species

Increase a home's sense of visual harmony by choosing optional interior wood species to coordinate with trim, cabinetry and furnishings. In addition to pine AuraLast® and AuraLast® Primed wood, we offer alder, which features a fairly straight grain that blends well with cherry, maple or birch grain and knotty patterns.



Pine AuraLast®
Wood



Mixed Grain
Douglas Fir



Pine AuraLast®
Primed



SUSTAINABLE
FORESTRY
INITIATIVE
SFI-00364

FSC® certified or SFI® certified wood available. See your JELD-WEN dealer for details.

Interior Finish Options.

1. Brilliant White
2. Ivory
3. Desert Sand
4. Clear Lacquer
5. Wheat
6. Cider
7. Fruitwood
8. Cordovan
9. Walnut



Custom color and stain options are available.
Ask your JELD-WEN representative for more details.

Colors shown may not match final finish

Interior Trim

Interior casings are available in pine and come in several patterns.
Corner blocks in pine are also available.



Pine Corner
Block



444



EXTERIOR OPTIONS



Trim Options

Primed Wood

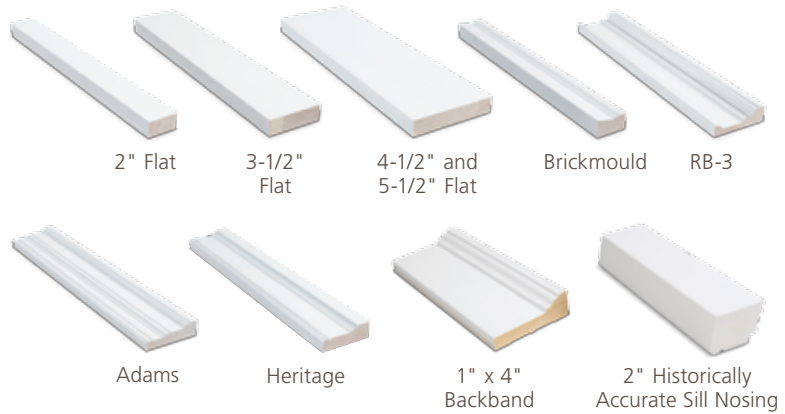

Clad

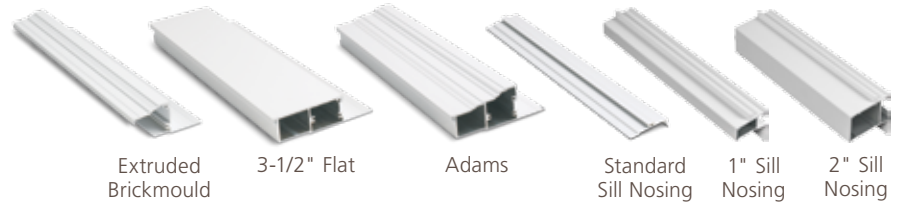

Clad Colors

Our windows and patio doors with clad-wood exteriors feature protective metal cladding with a baked-on finish that doesn't need to be repainted over time. We provide a number of clad color options, so you can pick a finish that will complement your home.

Optional Colors



Exterior Wood Species



Standard Clad Colors



Anodized Colors

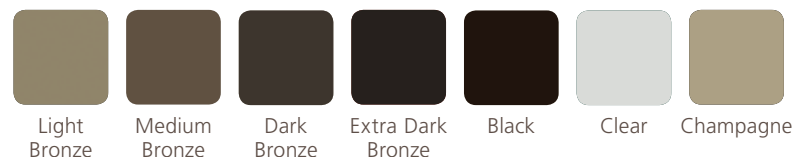

Actual colors may vary from the samples displayed.

HARDWARE

The Premium Wood swinging patio door can be outfitted with three new designs featuring concealed rod hardware that maximizes the beauty of the door by minimizing the visibility of the locking hardware - improving the aesthetic appeal. To increase ease of use, our hardware utilizes the babysitter feature; which means you don't need an instruction manual to lock the door. The enhanced locking mechanism also provides peace of mind that when the door is closed and locked, it is safeguarded in multiple places and is securely shut. It also has a feature that doesn't allow the door to be locked unless it's closed, which prevents damage to the door.

Handleset Options



Rustic (Multi-Point)



Contemporary (Multi-Point)



Classic (Multi-Point)

Hardware Finishes

	Oil-Rubbed Bronze*†	Antique Brass	Polished Brass†	Brushed Chrome	Satin Nickel†	Powder-Coat White
Classic	✓	✓	✓	✓	✓	✓
Contemporary				✓	✓	
Rustic	✓					

*Oil-Rubbed Bronze will change in appearance over time. Actual colors may vary from the samples displayed

†Available with optional PVD finish for increased resistance to wear and discoloration

GLASS OPTIONS

Tinted Glass

Tinted glass reduces glare, and is ideal for areas that get a lot of direct sunlight in the summer. We offer Clear, Green, Gray, Bronze, Reflective Gray and Reflective Bronze tinted glass.



Green



Gray



Bronze



Reflective Gray



Reflective Bronze

Textured Glass

Let light in while maintaining privacy with textured glass. We offer a wide range of textures to meet your aesthetic preferences. Four of our most popular choices are shown below; see your dealer for our complete offering.



Glue Chip



Rain



Obscure



Reed

Tempered Glass

This type of glass is treated with heat, so it can withstand greater force or pressure on its surface, and it will not break into sharp pieces. This is mostly used on patio doors or windows that are installed near floor level.



Images are for illustration purposes only. Objects may appear differently through actual glass.

DECORATIVE GLASS

Decorative Glass

Featuring five popular standard glass collections.

Note: Glass patterns will change based on size and style of window.



Contemporary
Collection



Estate
Collection



Classic
Collection



Craftsman
Collection



Diamond
Collection



Styles & Patterns

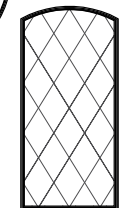
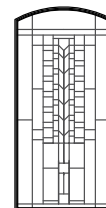
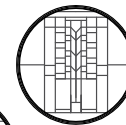
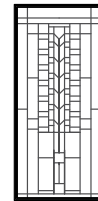
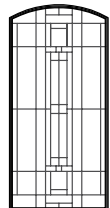
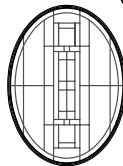
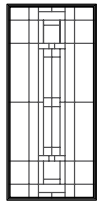
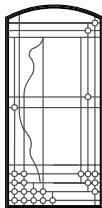
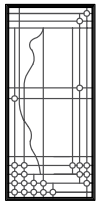

Caming Selections*: Choose one of our five caming selections to determine how your glass will appear.



Satin Nickel



Copper



Dark Patina



Brass



Polished Zinc

*Caming colors may not match actual finish.

HIGH PERFORMANCE GLASS

Glass Options

Low-E and LoE³-366 Insulating Glass

High-performance Low-E insulating glass comes standard and helps lower energy costs, allows homes to stay cooler in the summer and warmer in the winter, prevents fading of interior furnishings, and reduces condensation. It also delivers greater visible light transmittance than tinted glass.

We also offer optional LoE³-366 which provides even more protection against heat loss and fading, as well as greater energy savings.

Most windows and patio doors with Low-E glass are ENERGY STAR[®] qualified. ENERGY STAR products help Americans save energy, save money and reduce their carbon footprints. ENERGY STAR criteria for windows are based on the U-factor and Solar Heat Gain Coefficient (SHGC) combinations that provide significant energy efficiency for a given climate zone. It's easy! Just tell your JELD-WEN[®] dealer you want windows that are ENERGY STAR qualified for your climate zone.

For more information, visit www.jeld-wen.com/energyefficiency.

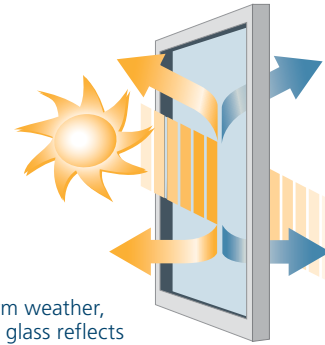

In cold weather, Low-E glass reduces the amount of heat lost by reflecting it back inside.

In warm weather, Low-E glass reflects the sun's energy and prevents it from entering the home.

ENERGY STAR[®]



Many JELD-WEN windows and doors are ENERGY STAR qualified. Homeowners can save energy—and money—by replacing old windows with ENERGY STAR qualified windows and pay a 7-15 percent lower household energy bill. Lower energy consumption also reduces greenhouse gas emissions from power plants and shrinks a house's carbon footprint. JELD-WEN has been an ENERGY STAR partner since 1998.

Preserve[®] Protective Film

Preserve[®] film is standard for all patio doors. It is factory-applied to both the interior and exterior surfaces of the glass. This means the glass surfaces will be protected from debris and scratches that can occur during shipping and handling or at a construction site, so you won't need to spend extra time cleaning your new windows and patio doors. What's more, it's easy to remove.



Neat[®] Glass

This glass comes standard and gives you natural cleaning convenience. By harnessing the sun's UV rays (even when the sky is cloudy) to loosen dirt from the glass, rainwater can easily rinse away grime. No manual activation is required.



DIVIDED LITES & SCREEN OPTIONS

Add architectural interest to your JELD-WEN® Premium Wood swinging patio doors with one of our divided lite options.



Simulated Divided Lites (SDL)



Grilles Between the Glass (GBG)



Full-Surround (FS) and Knocked-Down (KD) removable wood grilles

Simulated Divided Lites (SDL)

To achieve an authentic look, select our simulated divided lites (SDL). They feature grilles that are permanently attached to the exterior glass (aluminum for clad-wood exteriors wood) grilles adhered to the interior glass, and optional Light or Silver shadow bars that are placed between the two panes of insulating glass. Grilles are available in 5/8", 7/8", 1-1/8" and 1-3/8" sizes. We also offer 2-5/16" grilles for the classic look of a checkrail.

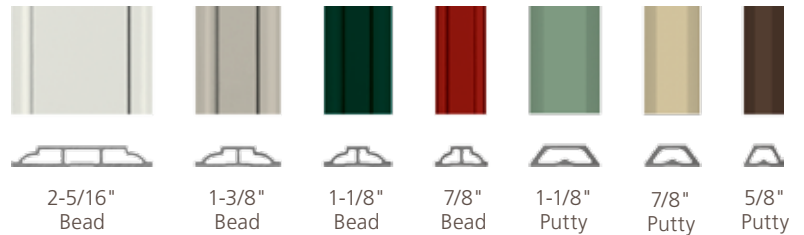

Grilles Between the Glass (GBG)

With grilles between the glass, you'll enjoy the look of divided lites without any upkeep. They are placed between the two panes of insulating glass. Select 5/8" flat or 23/32" or 1" contour metal grilles in any of our standard clad colors.

Full-Surround Wood Grilles (FS)

Our full-surround wood grilles can be removed for easy cleaning. Choose from 1-1/8", 1-3/8" or 7/8" grilles that are positioned on the interior glass surface.

Screen Options*

These screens are designed to keep insects outside while letting natural light inside. Choose a Bottom Rolling Extruded Screen or a Swinging Screen. If you prefer not to have a screen that is an option also. Our Fiberglass and BetterVue® screens feature fine, black fiberglass mesh with a light gloss finish. Aluminum screens are available in Charcoal or Silver.

**Insect screens are not intended to stop children from falling through an open door or window. For safety screens and other security devices, contact your local building supply retailer."*

JELD-WEN® WINDOW & PATIO DOOR LIMITED WARRANTY

OUR WARRANTY TO YOU...

JELD-WEN® Products¹ are designed to create lasting value for your home. This warranty is effective for all JELD-WEN window and patio door Products (except United Collection products) manufactured on or after **February 1, 2014** for use in the United States and Canada. Any previous warranties will continue to apply to products manufactured by JELD-WEN prior to this date. For additional information, including care and maintenance instructions, installation instructions, and previous warranties, refer to www.jeld-wen.com or www.jeld-wen.ca.

What this warranty **COVERS**

Except as set forth in the Special Coverages section below, we warrant that if your JELD-WEN Product exhibits a defect in material or workmanship within the time periods from the date of manufacture as specified below, we will, at our option, repair, replace or refund the purchase price of the Product or component part. Skilled labor² (where deemed necessary by us) to repair or replace any component is provided as specified below.

	Wood & Clad Wood	Vinyl	Aluminum (except Summit)	Summit Aluminum
Basic Product Coverage Owner-Occupied Single-Family Residence	20 years	as long as you own and occupy your residence	10 years	1 year
Basic Product Coverage Commercial (Other than Owner-Occupied Single-Family Residence)	20 years	10 years	2 years	1 year
Skilled Labor² Coverage	2 years	2 years	1 year	No coverage
Transferability - this length of coverage applies if you sell your residence or it becomes occupied by other than the original owner	10 years	10 years	Non-transferable	Non-transferable

Special Coverages (Applies to both Owner-Occupied and Commercial)

The following Special Coverages apply to special product features and options; not all options are available on all products or in all regions.

Glass Options	Coverage	Notes
Triple-Glazed Glass Units	20 years	Includes the glass panes and the insulating seal.
ImpactGard® Glass Units	10 years	
Special Glazings	5 years	Includes laminated glass units other than ImpactGard, and glass options not listed in our product literature, e.g., leaded or decorative glass.
Blinds/Shades Between the Glass	10 years	Includes the seal, external control mechanism, and operation of the shade/blind.
Spontaneous Glass Breakage	1 year	Applies to sealed glass units installed in windows and patio doors. Laminated glass and special glazings are excluded. Coverage includes replacement glass and skilled labor ² necessary to replace the glass for one year. (Spontaneous breakage occurs when the glass develops a crack without sign of impact.)
Accidental Glass Breakage	Same as the Basic Product Coverage above (Owner-Occupied or Commercial)	Applies to vinyl Products ordered with the "RS" glass package. Not covered: damage attributable to acts of nature (e.g. fire, hurricane, etc.), civil disorder, building settling, structural failures of walls or foundations or improper installation, construction job-site mishaps, storage, or handling. Special glazings and ImpactGard glass are not covered by this glass breakage warranty.
Finish Options	Coverage	Notes
Clad Finish on Wood Products	Kynar®: 20 years Polyester: 10 years Anodized: 5 years	Coverage is for peeling, checking, cracking, or exhibiting excessive chalk, fade or color change ³ . Clad products and products finished with factory applied Select Finish™ installed within one mile of a salt-water source (for example, an ocean or salt lake) or other corrosive environment require additional and specific maintenance requirements. Refer to our full care and maintenance instructions.
	10 years; 5 years at 100%, 50% thereafter 5 years	
Factory applied Select Finish™ exterior finish on Wood Products	10 years; 5 years at 100%, 50% thereafter 5 years	Coverage is for failure of adhesion, peeling, checking, flaking, cracking, or blistering. Coverage is for exhibiting excessive chalk, fade or color change ³ .
Factory Interior Finish on Wood Products	1 year	Coverage is for peeling, checking, or cracking. Should the factory interior finish be proven defective within this time period, we will at our option, replace or refinish the component or product, or offer a refinish credit up to \$50 per opening for windows or \$100 per opening for patio doors. This coverage applies to factory-applied finish coat options only; standard factory-applied primer is not a finish coat.
Colored Exterior and Laminated Interior on Vinyl Products	10 years	Coverage is for peeling, blistering, or flaking, and excessive color change ³ . This coverage does not extend to discoloration, polish, surface damage, or alteration caused by the use of natural or chemical solvents or an environmental factor causing such damage.

Continued on next page

Other Special Coverages	Coverage	Notes
AuraLast Protection for Wood Products	Owner-Occupied Single-Family Residence: as long as you own and occupy your residence	Coverage is for wood decay and/or termite damage in pine wood components. Warranty coverage outside Canada, the contiguous 48 states and Alaska is contingent upon approval from the JELD-WEN Customer Care Department. Please contact us.
	Commercial: 20 years	
Custom Fiberglass Door Slabs	As long as you own and occupy your residence	
Factory Prefinish on Custom Fiberglass Doors	5 years	Should the factory prefinish be proven defective, we will at our option refinish the door or pay up to \$350.00 per opening to the current owner.
Electric Operators	1 year	Coverage includes replacement parts and skilled labor necessary to replace the operator for one year.
Retractable Roll Screens	5 years	
Accidental Screen Damage	Same as the Basic Product Coverage above (Owner-Occupied or Commercial)	Applies to Bravo, Primo and Ipex Replacement window and patio door product lines. Not covered: damage attributable to acts of nature (e.g. fire, hurricane, etc.), civil disorder, building settling, structural failures of walls or foundations or improper installation, construction job-site mishaps, storage, or handling.

How To Get Assistance

If you have a problem with your JELD-WEN Product, contact the dealer/distributor or contractor from whom you purchased your product or contact us directly:

	In the United States:	In Eastern Canada:	In Western Canada:	In Ontario Canada
Mail:	JELD-WEN Customer Care Attn: Warranty Claims P.O. Box 1329 Klamath Falls, OR 97601	JELD-WEN Service Department 90, rue Industrielle Saint-Appollinaire, Quebec Canada G0S 2E0	JELD-WEN Service Department 550 Munroe Avenue Winnipeg, Manitoba Canada R2K 4H3	JELD-WEN Service Department 90 Stone Ridge Road Vaughan, Ontario Canada L4H 3G9
Phone:	888-JWHelpU 888-594-3578	800-463-1930	888-945-5627 204-668-8230	800-440-2714 905-265-5700
Fax:	800-436-5954	888-998-1599	204-663-1072	905-265-5704
E-mail:	jeldwenwarranty@jeld-wen.com		wpgservice@jeld-wen.com	
Web:	www.jeld-wen.com/contact-us			

We can respond quickly and efficiently if you provide the following: a) product identification (from the original order/invoice, spacer code, permanent label, or the window identification number found on corner of glass), b) how to contact you, c) the address where the product can be inspected, and d) a description of the apparent problem and the product (photographs are helpful).

What We Will Do

Upon receiving your notification, we will send out an acknowledgement within three business days to the contact, which you have provided. We will investigate your claim and will begin to take appropriate action within 30 days after receipt of notification. If your warranty claim is denied, we may charge an inspection fee for an onsite inspection that is required or requested by you.

If your claim is accepted, and we choose to repair or replace the product or a component of the product, the replacement product/component will be provided in the same specification as the original product. Replacement components/products are warranted for the balance of the original product warranty or 90 days, whichever is longer.

If the claimed nonconformity is warp of a door slab, we may defer repairing or replacing the door slab for a period up to twelve (12) months from the date of claim. It is not uncommon for a temporary warp condition to occur as the door slab adjusts to local humidity and temperature conditions. This deferral will not be counted against the warranty period.

What This Warranty Does NOT Cover

JELD-WEN is not liable for damage, product failure or poor product performance due to:

- Normal wear and tear, including normal wear and tear of weatherstrip; natural weathering of surfaces. Variance in color or texture of natural wood parts, and natural tarnishing of copper cladding are not considered defects.
- Normal wear and tear to hardware and naturally occurring changes to hardware finishes (e.g., corrosion or tarnishing).
- Exposure to chemicals (e.g. brick wash) or a harsh environment (e.g. salt spray or airborne pollutants) unless otherwise stated above.
- Misuse, abuse or failure to properly finish and provide maintenance.
- Alteration or modification to the Product (e.g. customer applied tints or films, paint finishes, security systems).

- Any cause beyond the reasonable control of JELD-WEN (e.g. fire, flood, earthquake, other acts of nature, and acts of third parties outside of our control).
- Failure to provide an adequate overhang for fiberglass doors; damage caused by extreme temperature buildup where storm doors are present. For general guidelines, see our "Appropriate Protection for Exterior Doors" in our product literature or at www.jeld-wen.com/ resources; for specific information pertaining to your structure, consult your contractor or other building professional.
- Improper installation not in conformance with JELD-WEN installation instructions (note: see www.jeld-wen.com/ for current installation instructions); operational problems and problems related to water and/or air infiltration/leaking as a result of improper installation or flaws in building design or construction.
- Installation into a condition that exceeds product design standards and/or certified performance specifications and/or is not in compliance with building codes.
- Extreme artificial temperature buildup or exposure (e.g., where storm doors/windows are present).
- Hardware or inserts that are not provided by us, such as locksets, door handles, strikes, etc.
- Condensation or damage as a result of condensation (Note: unless due to insulating glass failure, most condensation problems are related to excessive humidity levels in a structure. Contact a heating/air conditioning specialist for help).
- Wood decay in wood components other than of pine species and any components (including pine) that come in direct contact with soil. Note: superficial mold/mildew does not indicate wood decay.

JELD-WEN is also not liable for:

- Glass breakage (except as covered above).
- Screen damage due to normal wear and tear, misuse, abuse, or insect or animal activity (except as specifically covered above).
- Slight expansion or contraction due to varying environmental conditions; slab movement (shrinkage or swelling) of 1/4" or less due to temperature and humidity, consult the Homeowner's Manual on how to work with this natural movement.
- Slight imperfections or wavy distortions in the glass that don't impair structural integrity. Note: wavy distortions in the glass (e.g. related to laminate interlayer or heat strengthening of glass) are not considered a defect. Slight color variations in glass are not considered a defect.
- Hairline cracks in factory-applied finishes; surface cracks that do not compromise the underlying material are not a defect.
- Damage or distortion to other property, including but not limited to, vinyl siding, building components or landscaping caused in whole or in part by reflection of light or heat from JELD-WEN windows or doors.
- Product or component performance decline due to aging, inert gas dissipation, natural processes or failure to provide proper maintenance. Note: Other than inert gas loss due to seal failure, the migration of an inert gas, such as argon, is a natural process that occurs over time and is not a defect.
- Labor and materials for repainting or refinishing activities or the removal or disposal of defective product(s); labor exceeding the time periods specified above.
- Incidental or consequential damage. Some states/provinces do not allow the exclusion or limitation of incidental or consequential damages, so this may not apply to you.

Important Legal Information -- Please read this carefully. It affects your rights.

This Limited Warranty document sets forth our maximum liability for our products. We shall not be liable for special, indirect, consequential, or incidental damages. Your sole and exclusive remedy with respect to any and all losses or damages resulting from any cause whatsoever shall be as specified above. We make no other warranty or guarantee, either express or implied, including implied warranties of merchantability and fitness for a particular purpose to the original purchaser or to any subsequent user of the Product, except as expressly contained herein. In the event state or provincial law precludes exclusion or limitation of implied warranties, the duration of any such warranties shall be no longer than, and the time and manner of presenting any claim thereon shall be the same as, that provided in the express warranty stated herein. This Limited Warranty document gives you specific legal rights, and you may have other rights that vary from state/province to state/province.

Any dispute, controversy or claim arising out of or relating to this warranty, any alleged breach thereof, or the use or sale of the products to which this warranty applies shall be resolved by mandatory and binding arbitration administered by the American Arbitration Association in accordance with its commercial arbitration rules. Original purchaser agrees that they may assert claims against JELD-WEN in their individual capacity only, and not as a plaintiff or class member in any purported class action proceeding. Rejection of these dispute resolution provisions must be sent to JELD-WEN at the address provided herein within thirty (30) days of original purchaser's receipt of the Products to which this warranty applies.

No distributor, dealer or representative of JELD-WEN has the authority to change, modify or expand this warranty. The original purchaser of this Product acknowledges that they have read this warranty, understand it and are bound by its terms and agrees to provide this warranty to the original owner of the structure into which the Product is installed.

¹"JELD-WEN Products" shall refer to window and patio door products (except United Collection products) manufactured in the United States and/or Canada and marketed under the JELD-WEN brand name for use in the United States and/or Canada. See our separate United Collection warranty, or our Export Warranty for applicable coverage on products used outside the United States and Canada.

²"Skilled labor" refers to tasks where specialized technical knowledge, experience, methods or tools are required to properly identify, diagnose and/or correct product-related problems.

³"Chalking" of the exterior finish is not a defect unless it exceeds a numerical rating of eight (8) when measured in accordance with the standard procedures specified in ASTM D4214. Fading or changing in color of the exterior finish is not a defect unless it exceeds five (5) E units, calculated in accordance with ASTM D2244, paragraph 6.2. Color change shall be measured on an exposed area of finish that has been cleaned of surface soils and chalk, and the corresponding values measured on the original or unexposed area of finish. Fading or color changes may not be uniform if the surfaces are not equally exposed to the sun and elements. If the above ASTM standards change, the standard in effect at the time of purchase applies. As an option to replacement, we may choose to refinish the product.

The JELD-WEN® website is your ultimate resource for learning about our reliable windows and doors. It has all the product information and design advice you need. Visit us at jeld-wen.com today.



JELD-WEN is proud to support
a better way to build

© 2014 JELD-WEN, inc. This publication and its contents are owned by JELD-WEN, inc. and are protected under the U.S. Copyright Act and other intellectual property laws. All trademarks, service marks, logos, and the like (whether registered or unregistered) are owned or controlled by JELD-WEN, inc. or others. Unauthorized use or duplication of JELD-WEN intellectual property is prohibited. JELD-WEN reserves the right to change product specifications without notice. Please check our website, jeld-wen.com, for current information.

11-92674 11/14 (SB 06/14 5M)