



Thank you for selecting JELD-WEN products. Attached are JELD-WEN's recommended installation instructions for Double-Hung Sash Replacement Kits, designed to be installed into an existing window frame. Replacement sashes are installed from the interior, and interior detail work is needed to complete the installation. Consult your local building department for applicable building codes and regulations (particularly regarding minimum egress requirements). Local building code requirements supersede recommended installation instructions. Areas such as Florida and the Texas TDI region have different anchoring requirements based on product certification. For information on specific products, visit [www.floridabuilding.org](http://www.floridabuilding.org) or [www.tdi.texas.gov](http://www.tdi.texas.gov) and follow the anchoring schedule given in the drawings for the product instead of the anchoring schedule in this document.

Newer construction methods have led to an increase in air and water tightness in buildings. This frequently leads to negative air pressure inside the home, which can draw water through very small openings. Our installation method integrates the window with the weather barrier of the structure (typically building wrap).

### IMPORTANT INFORMATION AND GLOSSARY

**Please Note!** The installation of a sash replacement kit will not eliminate installation or maintenance problems with an existing window. Problems such as wood decay and water leaks around the existing frame must be investigated and fixed prior to installing a sash replacement kit. Installation such that the window sill is higher than 35 feet above ground level or any window installation into a condition not specifically addressed in these instructions must be designed by an architect or structural engineer. Failure to install into a square, level and plumb condition could result in denial of warranty claims for operational or performance problems.

**Note to Installer:** Provide a copy of these instructions to the building owner. By installing this product, you acknowledge the terms and conditions of the limited product warranty as part of the terms of the sale.

Read these installation instructions thoroughly before beginning. They are designed to work in most existing applications. However, existing conditions may require changes to these instructions. If changes are needed, they are made at the installer's risk. For installations other than indicated in these instructions, contact a building professional.

#### GLOSSARY

##### Balance System

A system of ropes and pulleys (older) or springs (newer) used to counter balance the weight of a sash.

##### Clutch

A part of the balance system into which the pivot pins are inserted or engaged.

##### Head Jamb

The horizontal frame element at the top of the window.

##### Jamb Liner

An assembly of vinyl and various types of springs that fits inside the side jambs of the frame and allows the sash to operate smoothly.

##### Pivot Pin

The pin on the bottom corners of the sash that engages the balance system and allows sash to pivot for easy removal and installation.

##### Sash

An assembly comprised of stiles (vertical pieces), rails (horizontal pieces) and the window's glass.

##### Sash Lock

The primary lock on the sash that secures the window opening.

##### Side Jambs

The vertical frame elements on either side of the window.

##### Sill

The horizontal frame element at the bottom of the window.

##### Stop

A moulding used to hold, position or separate window and door parts. Can also be called a trim stop or parting stop and can be located on any side within the frame.

##### Window Frame

The outer assembly (side jambs, head jamb and sill) that contains the sash(es) and attaches to the rough opening.

Estimated Install Time for New Construction	<input type="text"/>	First Time: 2 hrs
	<input type="text"/>	Experienced: 1.5 hrs
	<input type="text"/>	Professional: 1 hr



## MATERIALS AND TOOLS

### INCLUDED PARTS

- Upper and lower sash.
- Wood head jamb cover with weatherstrip.
- Jamb liners with hardware.
- Two foam jamb liner gaskets or chimney plugs.
- Siteline EX/W-4500 kits include an optional head jamb filler.
- W-2500 kits include six black rubber snubbers.
- Custom kits include two foam sheet spacing material for use behind the jamb liners.

### NEEDED MATERIALS

- Finish nails
- Silicone sealant

### NEEDED TOOLS

- Hammer
- Screwdrivers
- Putty knife or pry bar
- Nail set
- Utility knife
- Tape measure
- Level
- Drill (optional)

## SAFETY AND HANDLING

### SAFETY

- Read and fully understand ALL manufacturer's instructions before beginning. Failure to follow proper installation instructions may result in the denial of warranty claims for operational or performance problems.
- Do not work alone. Two or more people are required. Use safe lifting techniques.
- Use caution when handling glass. Broken or cracked glass can cause serious injury.
- Wear protective gear (e.g. safety glasses, gloves, ear protection, etc.).
- Operate hand/power tools safely and follow manufacturer's operating instructions.
- Use caution when working at elevated heights.
- If disturbing existing paint, take proper precautions if lead paint is suspected (commonly used before 1979). Your regional EPA ([www.epa.gov/lead](http://www.epa.gov/lead)) or Consumer Product Safety Commission offices provide information regarding regulations and lead protection.

- **WARNING:** Drilling, sawing, sanding or machining wood products generates wood dust, a substance known to the State of California to cause cancer. Use a respirator or other safeguards to avoid inhaling wood dust.

### WINDOW AND MATERIALS HANDLING

- Heed material manufacturer's handling and application instructions.
- Handle in vertical position; do not carry flat or drag on floor.
- Store window in dry, well-ventilated area in vertical, leaning position to allow air circulation; do not stack horizontally.
- Protect from exposure to direct sunlight during storage.

**IF INJURY OCCURS, IMMEDIATELY SEEK MEDICAL ATTENTION!**

## 1 REMOVE PACKAGING AND INSPECT WINDOW PARTS

### REMOVE PACKAGING

Remove shipping materials such as corner covers, shipping blocks or pads. If there is a protective film on the glass, do not remove it until installation and construction are complete.

### INSPECT WINDOW

- Cosmetic damage.
- Included parts.
- Correct product (size, color, grid pattern, handing, glazing, energy-efficiency requirements, etc.).

If any of the above represents a concern, **BEFORE** installing, contact your dealer or distributor for recommendations.

**2 REMOVE EXISTING SASH AND PREPARE OPENING**

**INSPECT EXISTING WINDOW FRAME**

**IMPORTANT:** This kit is designed to be installed into a structurally sound, plumb and square opening. Failure to do so will negatively impact the fit and performance of this product.

- Verify and correct any problems with the existing frame such as wood decay and water leaks prior to installing replacement sashes.
- Verify the existing window frame is square. The (A) and (B) measurements should be the same. Maximum allowable deviation from square is 1/8" for windows 20 sq. ft. and smaller, and 1/4" for windows larger than 20 sq. ft.
- Verify the existing window frame is level and plumb (C, E and D). The maximum allowable deviation is 1/16" for every 2' of rough opening (not to exceed 1/8").
- The rough opening sill must not be crowned or sagged (D), but rather be level or sloped (positive slope) to the exterior.
- The interior face of the existing window frame must be in a single plane (E) with less than 1/8" twist from corner to corner.

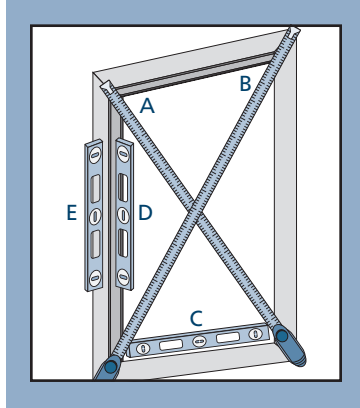

**Do not install the new replacement system unless the existing window frame meets the above conditions. Professional assistance may be necessary to correct problems before installation.**

**IMPORTANT:** The replacement sash should be finished either before installation or immediately after (whichever is more convenient).

**REMOVE EXISTING BALANCE SYSTEM AND SASHES**

1. Remove any interior trim stops at head or sides flush with jambs. Interior trim stops may be reused if not damaged.
2. Remove existing lower sash and balance system. If the balance system has balance cords, cut cords and gently lower weights into frame.
3. Remove existing head and jamb parting stops. Remove upper sash in the same manner as the lower sash.
4. Unscrew pulleys and remove, or tap into frame until flush with the jamb. Fill any holes left by the balance system with loose-fill insulation or low expansion foam.

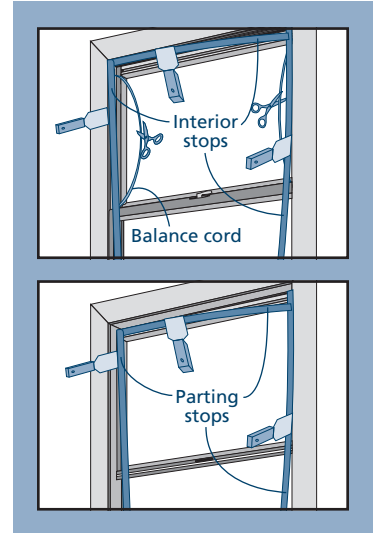

**FOR RETROFIT INSTALLATIONS**

After removing the old window, contact your local waste management entities for proper disposal or recycling of products being removed.

**3 PREPARE FRAME**

**SITELINE EX/W-4500 KITS**

Steps 1 and 2 apply to Siteline EX/W-4500 kits only. All others begin with step 3.

1. Position a jamb liner (without brackets) against the side jamb. Measure the gap between the top of the jamb liner and the head jamb. If that distance is 3/8", install the optional head jamb filler. If the gap is less than 3/8", omit the head jamb filler.
2. If the head jamb filler is needed, position in place with the front weatherstrip flange facing the exterior of the house. Secure with finishing nails.
3. Position one jamb liner bracket next to the exterior blind stop and approximately 4" down from the head jamb as shown. Secure the bracket with the common nails included in the kit. Secure a second jamb liner bracket 4" above the sill. Repeat on the other side of the frame.
4. Secure the remaining brackets, using half the brackets on the left side and half on the right side, and spacing them evenly between the upper and lower brackets.

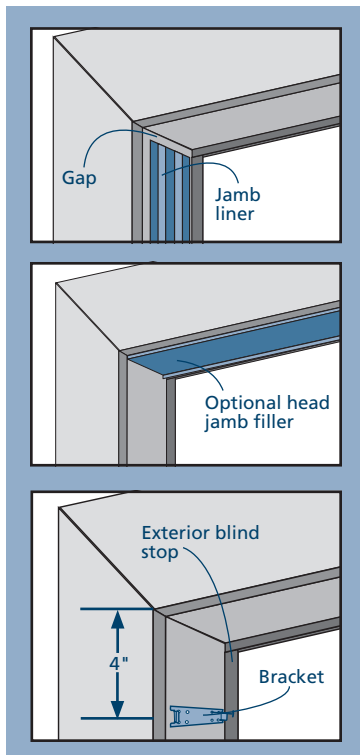

5. For W-2500 kits, install three black snubbers on the back of each jamb liner in the locations shown. Install one snubber at the bottom and one at the middle of the interior channel. Install the third snubber at the top of the exterior channel.
6. Install a chimney plug or adhesive gasket (remove paper backing first) onto the top of each jamb liner in the position shown.
7. Starting from the top, press a jamb liner into the brackets until it snaps into place. Install the other jamb liner the same way. If there is integral weatherstrip on the exterior of the jamb liner, it should lay over the exterior stop, not tucked behind it.

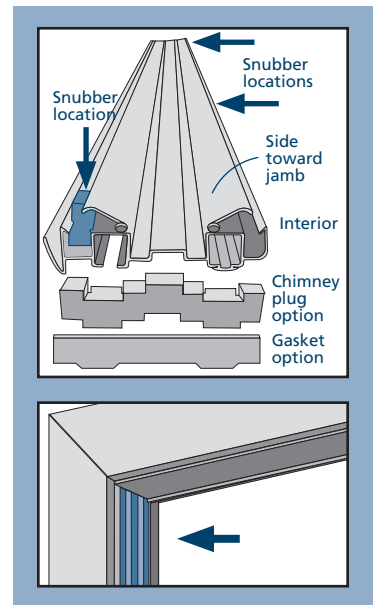

**Note!** If jamb liners do not snap into place easily, the prongs on the brackets may be adjusted by gently bending them with a screwdriver or putty knife.

**CUSTOM KITS**

1. Remove the paper backing and adhere a sheet of foam spacer material to the back of each jamb liner.
2. Position a jamb liner tightly against the exterior side stop.
3. Fasten the jamb liners to the frame through the pre-drilled holes with the provided screws.

**4**

**INSTALL SASHES**

**Warning!** Some sashes may be very heavy, use at least two people to install.

**INSTALL UPPER SASH**

1. Install the upper sash (sash with lock keeper) first. Hold the sash horizontally with the right side slightly lower than the left side. Insert the right pivot pin on the sash into the jamb liner track nearest the exterior and above the clutch. If there is a hole in the clutch, insert the pin into the hole.
2. Hold the sash so that the pivot pin remains above (or in) the clutch and lower the left side of the sash into the jamb liner track nearest the exterior until the sash is horizontal. If the clutch has a hole, the right side may need to be lowered to allow the left pin to slip into the hole.
3. If the sash has retainer latches, pull them both toward the center and tilt the sash up into place.
4. If the sash does not have retainer latches, simultaneously press against both jamb liners and tilt the sash up into place.

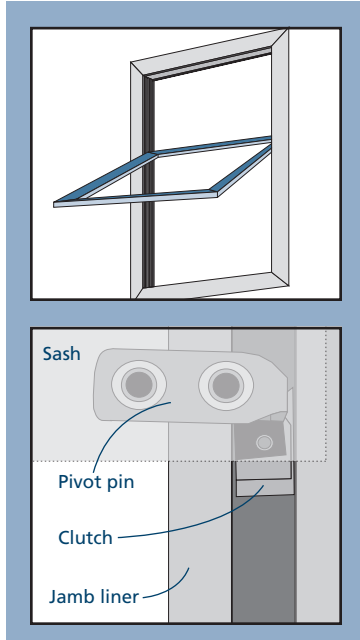

5. Make sure the sash is positioned properly on the same track as the pivot pins.
6. Slide the sash all the way down. Test sash for proper operation and remove and reinstall if necessary.

**INSTALL HEAD JAMB COVER**

1. With the weatherstrip facing the exterior, position the wood head jamb cover horizontally between the jamb liners on the inside tracks. If the cover is not profiled on the ends, it can be trimmed to fit if necessary. Slide the cover all the way to the top and check for proper fit. The weatherstrip should be slightly compressed by the upper sash when closed.
2. After making any necessary adjustments, remove the cover and apply a 1/8" bead of sealant across the upper surface of the head jamb cover. Press the cover in position against the head jamb and secure with finishing nails.

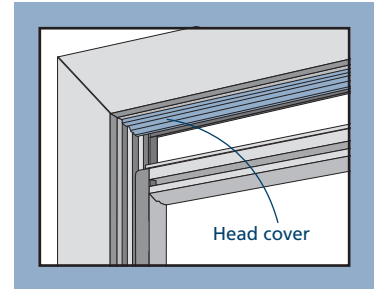

**INSTALL LOWER SASH**

To install the lower sash, repeat the steps to install the upper sash except insert the pivot pins into the jamb liner track nearest the interior.

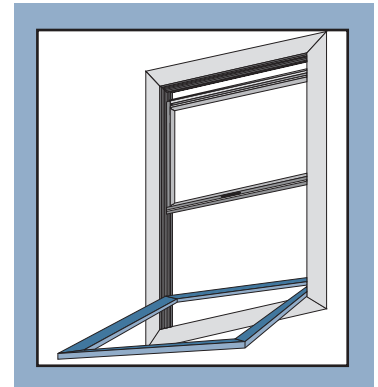

**5**

**COMPLETE INSTALLATION**

- Close both sashes and test the lock to make sure both sashes are in the correct alignment.
- Apply a bead of sealant along the interior side of the jamb liners.
- Reinstall the original interior stops and trim, or replace with new millwork.
- Finish any exposed wood surfaces. Aluminum cladding does not require additional finishing.

Please visit [jeld-wen.com](http://jeld-wen.com) for warranty and care and maintenance information.

Thank you for choosing

