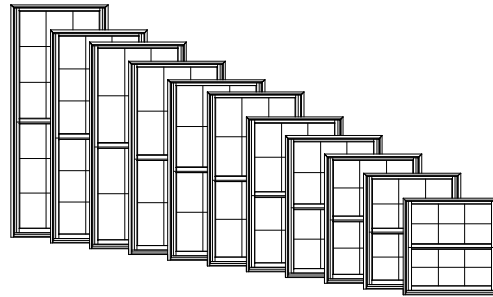

TABLE OF CONTENTS

General Information	2-2
Elevations/Sizes: 1/4" & 1/8" Scale	
Single Units	2-5
Twin Units	2-14
Triple Units	2-21
4-Wide Units	2-29
5-Wide Units	2-31
Double-Hung Picture	2-34
Double-Hung Transom	2-44
Glazing Options	2-50
Jamb Extender Options	2-51
Standard Mullion Options	2-52
Lite Cut Information	2-54
Unit Sizing Information	2-56
Clear Opening Layout	2-57
Section Details	2-58

GENERAL INFORMATION



Clad double hung windows feature fully operating upper and lower sash. Counterbalancing is achieved with helical spring extension systems hidden in weatherable PVC jamb liners. Operating units are supplied with cam-type sash locks installed. There are several hardware finish options. Refer to the Specifications for available finish options.

MULTIPLE ASSEMBLIES

Clad double hung windows may be mullied beside other clad double hungs or clad picture windows, or below clad transom windows, to fulfill a wide variety of needs. Factory assembled mulls are limited in height (100"), width (114"), and a total area (75 square feet).

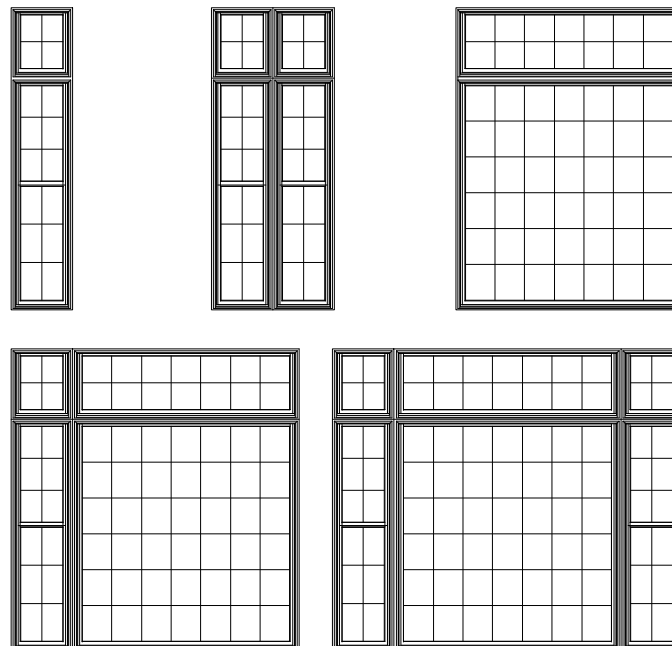

ELEVATION NOTES

ELEVATION DRAWINGS UTILIZE A LIMITED NUMBER OF PROJECTED LINES TO PRODUCE A RUDIMENTARY DRAWING INTENDED TO BE USED IN A SMALL GRAPHICAL SCALE. ELEVATIONS ARE VIEWED PERPENDICULAR FROM THE EXTERIOR OF THE STRUCTURE. IF MORE DIMENSIONS ARE NEEDED, USE THE SECTION DRAWINGS FOR MORE COMPLETE DEPICTIONS.

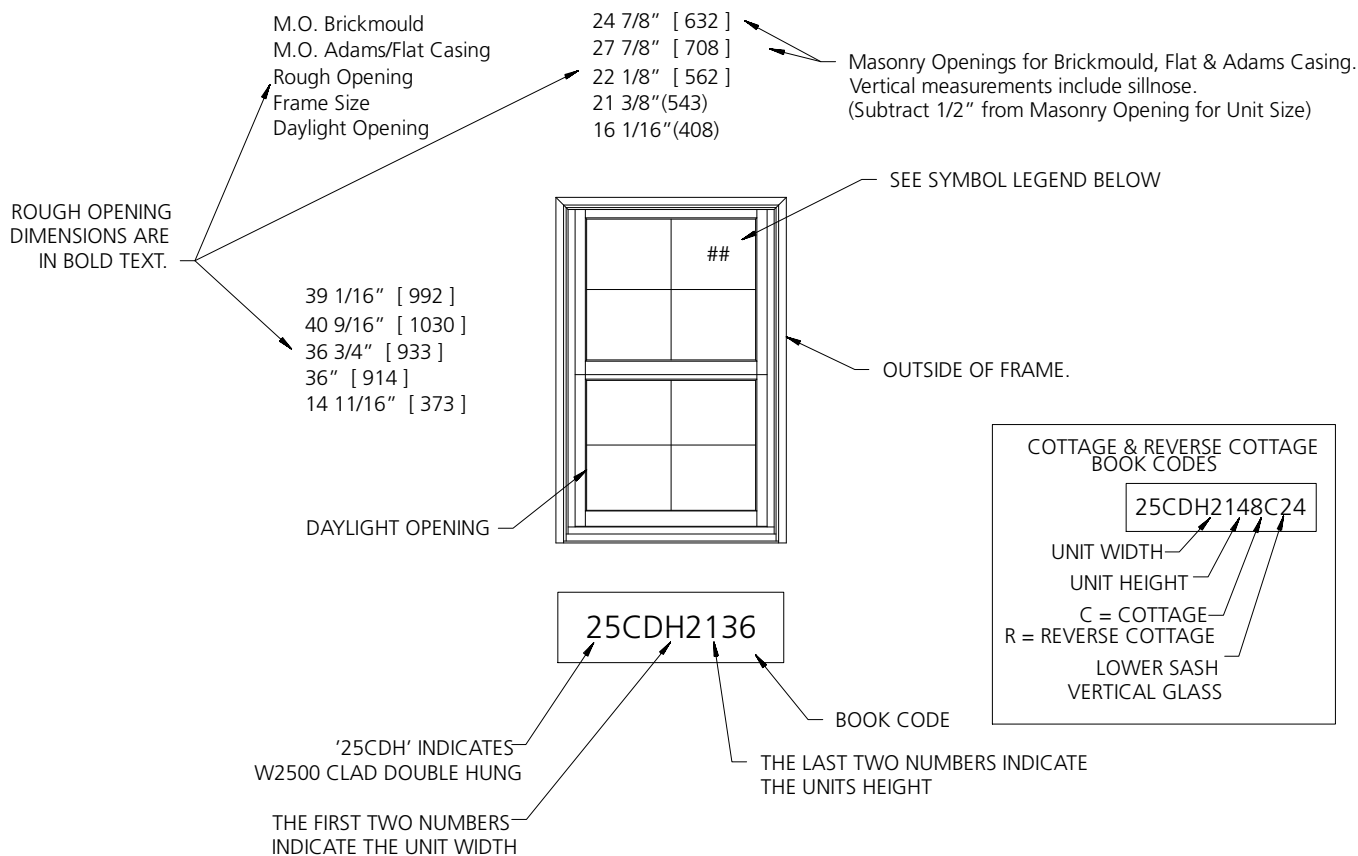

GENERAL DOUBLE HUNG NOTES

1. ALL UNITS SHOWN ARE AVAILABLE AS OPERATORS ONLY.
2. UNIT ELEVATIONS ARE SHOWN WITHOUT EXTERIOR TRIM.
3. ALL OPERATING SASH ARE INSTALLED WITH VINYL JAMB LINERS AND OPERATED WITH AN INTERNAL HELICAL SPRING SYSTEM.
4. DIMENSIONAL VALUES IN BRACKETS ARE MILLIMETER CONVERSIONS.

ELEVATION SYMBOL LEGEND:

- E** BASIC UNIT CLEAR OPENING EXCEEDS 20" IN WIDTH, 24" IN HEIGHT & A MINIMUM OF 5.7 SQ. FT.
- ##** NUMBER INDICATES DESIGN PRESSURE (DP) RATING WITH STANDARD GLAZING.

OPERATION & SASH TILTING

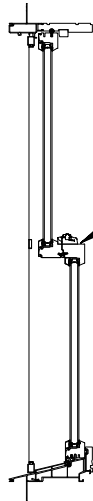

DOUBLE HUNG OPERATION:
When the sash are locked at the check rails the sash are closed and sealed in the sash opening of the frame.

When the sash are unlocked the lower sash travels vertically to any position desired. The upper sash can also be positioned as desired.

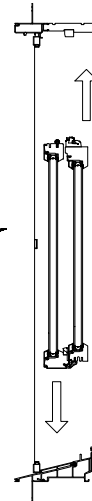





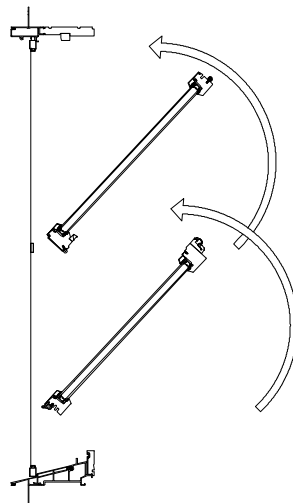



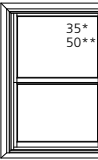



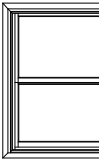
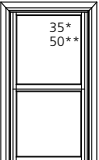
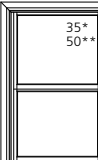
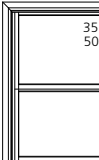

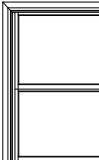
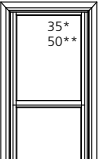
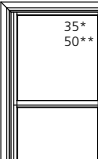
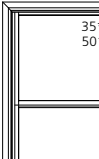



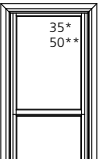
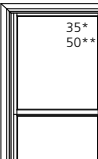
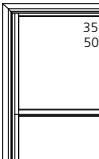



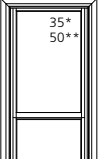
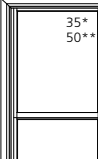

SASH TILTING FOR WASHING

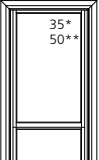
The Custom Double Hung window will allow the sash to be tilted or removed for easy cleaning.



SINGLE UNITS

UNIT SIZE	24 1/8"(613)	28 1/8"(714)	32 1/8"(816)	36 1/8"(918)	40 1/8"(1019)	44 1/8"(1121)
ROUGH OPENING	22 1/8"(562)	26 1/8"(664)	30 1/8"(765)	34 1/8"(867)	38 1/8"(968)	42 1/8"(1070)
FRAME SIZE	21 3/8"(543)	25 3/8"(645)	29 3/8"(746)	33 3/8"(848)	37 3/8"(949)	41 3/8"(1051)
DAYLIGHT OPENING	16 1/16"(408)	20 1/16"(510)	24 1/16"(611)	28 1/16"(716)	32 1/16"(814)	36 1/16"(916)
38 3/4"(984) 36 3/4"(933) 36"(914) 14 11/16"(373)[2]	 25CDH2136	 25CDH2536	 25CDH2936	 25CDH3336	 25CDH3736	 25CDH4136
42 3/4"(1086) 40 3/4"(1035) 40"(1016) 16 1/16"(424)[2]	 25CDH2140	 25CDH2540	 25CDH2940	 25CDH3340	 25CDH3740	 25CDH4140
50 3/4"(1289) 48 3/4"(1238) 48"(1219) 20 1/16"(525)[2]	 25CDH2148	 25CDH2548	 25CDH2948	 25CDH3348	 25CDH3748	 25CDH4148
54 3/4"(1391) 52 3/4"(1340) 52"(1321) 22 1/16"(566)[2]	 25CDH2152	 25CDH2552	 25CDH2952	 25CDH3352	 25CDH3752	 25CDH4152
58 3/4"(1492) 56 3/4"(1441) 56"(1422) 24 1/16"(627)[2]	 25CDH2156	 25CDH2556	 25CDH2956	 25CDH3356 E1	 25CDH3756 E1	 25CDH4156 E3
62 3/4"(1594) 60 3/4"(1543) 60"(1524) 26 1/16"(678)[2]	 25CDH2160	 25CDH2560	 25CDH2960	 25CDH3360 E2	 25CDH3760 E4	 25CDH4160 E3

ELEVATION SYMBOL LEGEND:

VALUES IN () ARE IN MILLIMETER CONVERSIONS.

VALUES IN [] ARE NUMBER OF DAYLIGHT OPENINGS PER UNIT.

##* NUMBER INDICATES DESIGN PRESSURE (DP) RATING WITH STANDARD GLAZING.

##** NUMBER INDICATES OPTIONAL DESIGN PRESSURE (DP) RATING.

E1 UNITS WITH AN E1 EGRESS DESIGNATION MEET 5.0 SQ FT EGRESS WITH A DP35 SILL STOP, BUT NOT WITH A DP 50 SILL STOP.

E2 UNITS WITH AN E2 EGRESS DESIGNATION MEET 5.0 SQ FT EGRESS WITH EITHER A DP35 OR A DP 50 SILL STOP.

E3 UNITS WITH AN E3 EGRESS DESIGNATION MEET 5.7 SQ FT EGRESS WITH A DP35 SILL STOP, BUT NOT WITH A DP 50 SILL STOP.

E4 UNITS WITH AN E4 EGRESS DESIGNATION MEET 5.0 SQ FT EGRESS WITH EITHER A DP35 OR A DP 50 SILL STOP.

SCALE: 1/4" = 1'

SINGLE UNITS

UNIT SIZE
ROUGH OPENING
FRAME SIZE
DAYLIGHT OPENING

24 1/8"(613)
22 1/8"(562)
21 3/8"(543)
16 1/16"(408)

28 1/8"(714)
26 1/8"(664)
25 3/8"(645)
20 1/16"(510)

32 1/8"(816)
30 1/8"(765)
29 3/8"(746)
24 1/16"(611)

36 1/8"(918)
34 1/8"(867)
33 3/8"(848)
28 1/16"(716)

40 1/8"(1019)
38 1/8"(968)
37 3/8"(949)
32 1/16"(814)

44 1/8"(1121)
42 1/8"(1070)
41 3/8"(1051)
36 1/16"(916)

66 3/4"(1695) 64 3/4"(1645) 64"(1626) 27 11/16"(703)[2]								
	25CDH2164	25CDH2564	25CDH2964	25CDH3364	25CDH3764	25CDH4164		
	70 3/4"(1797) 68 3/4"(1746) 68"(1727) 30 11/16"(779)[2]							
		25CDH2168	25CDH2568	25CDH2968	25CDH3368	25CDH3768		
		74 3/4"(1899) 72 3/4"(1848) 72"(1829) 32 11/16"(830)[2]						
			25CDH2172	25CDH2572	25CDH2972	25CDH3372	25CDH3772	
78 3/4"(2000) 76 3/4"(1949) 76"(1930) 34 11/16"(881)[2]								
			25CDH2176	25CDH2576	25CDH2976	25CDH3376	25CDH3776	

ELEVATION SYMBOL LEGEND:

VALUES IN () ARE IN MILLIMETER CONVERSIONS.

VALUES IN [] ARE NUMBER OF DAYLIGHT OPENINGS PER UNIT.

NUMBER INDICATES DESIGN PRESSURE (DP) RATING WITH STANDARD GLAZING.

NUMBER INDICATES OPTIONAL DESIGN PRESSURE (DP) RATING.

E1 UNITS WITH AN E1 EGRESS DESIGNATION MEET 5.0 SQ FT EGRESS WITH A DP35 SILL STOP, BUT NOT WITH A DP 50 SILL STOP.

E2 UNITS WITH AN E2 EGRESS DESIGNATION MEET 5.0 SQ FT EGRESS WITH EITHER A DP35 OR A DP 50 SILL STOP.

E3 UNITS WITH AN E3 EGRESS DESIGNATION MEET 5.7 SQ FT EGRESS WITH A DP35 SILL STOP, BUT NOT WITH A DP 50 SILL STOP.

E4 UNITS WITH AN E4 EGRESS DESIGNATION MEET 5.0 SQ FT EGRESS WITH EITHER A DP35 OR A DP 50 SILL STOP.

SCALE: 1/4" = 1'

SINGLE UNITS - NOMINAL

	UNIT SIZE	22"(559)	26"(660)	30"(762)	34"(864)	38"(965)
	ROUGH OPENING	20"(508)	24"(610)	28"(711)	32"(813)	36"(914)
	FRAME SIZE	19 1/4"(489)	23 1/4"(591)	27 1/4"(692)	31 1/4"(794)	35 1/4"(895)
	DAYLIGHT OPENING	13 15/16"(354)	17 15/16"(455)	21 15/16"(557)	25 15/16"(659)	29 15/16"(760)
38"(965) 36"(914) 35 1/4"(895) 14 5/16"(364)[2]						
44"(1118) 42"(1067) 41 1/4"(1048) 17 5/16"(440)[2]						
50"(1270) 48"(1219) 47 1/4"(1200) 20 5/16"(515)[2]						
56"(1422) 54"(1372) 53 1/4"(1353) 23 5/16"(592)[2]						
62"(1575) 60"(1524) 59 1/4"(1505) 26 5/16"(668)[2]						

ELEVATION SYMBOL LEGEND:

VALUES IN () ARE IN MILLIMETER CONVERSIONS.

VALUES IN [] ARE NUMBER OF DAYLIGHT OPENINGS PER UNIT.

NUMBER INDICATES DESIGN PRESSURE (DP) RATING WITH STANDARD GLAZING.

NUMBER INDICATES OPTIONAL DESIGN PRESSURE (DP) RATING.

E1 UNITS WITH AN E1 EGRESS DESIGNATION MEET 5.0 SQ FT EGRESS WITH A DP35 SILL STOP, BUT NOT WITH A DP 50 SILL STOP.

E2 UNITS WITH AN E2 EGRESS DESIGNATION MEET 5.0 SQ FT EGRESS WITH EITHER A DP35 OR A DP 50 SILL STOP.





E3 UNITS WITH AN E3 EGRESS DESIGNATION MEET 5.7 SQ FT EGRESS WITH A DP35 SILL STOP, BUT NOT WITH A DP 50 SILL STOP.

E4 UNITS WITH AN E4 EGRESS DESIGNATION MEET 5.0 SQ FT EGRESS WITH EITHER A DP35 OR A DP 50 SILL STOP.

N INDICATES NOMINAL SIZING.

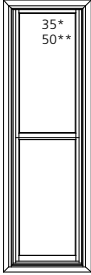
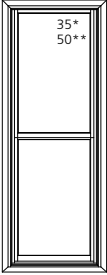
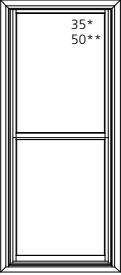
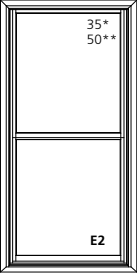
SCALE: 1/4" = 1'

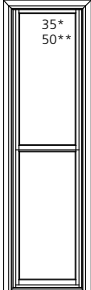
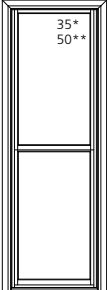
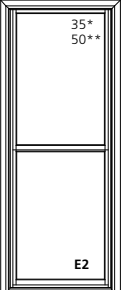
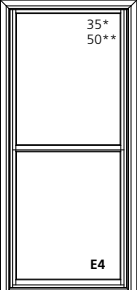
SINGLE UNITS - NOMINAL

UNIT SIZE	22"(559)	26"(660)	30"(762)	34"(864)	38"(965)	
ROUGH OPENING	20"(508)	24"(610)	28"(711)	32"(813)	36"(914)	
FRAME SIZE	19 1/4"(489)	23 1/4"(591)	27 1/4"(692)	31 1/4"(794)	35 1/4"(895)	
DAYLIGHT OPENING	13 15/16"(354)	17 15/16"(455)	21 15/16"(557)	25 15/16"(659)	29 15/16"(760)	
68"(1727) 66"(1676) 65 1/4"(1657) 29 5/16"(745)[2]						
	25CDH2066N	25CDH2466N	25CDH2866N	25CDH3266N	25CDH3666N	
	74"(1880) 72"(1829) 71 1/4"(1810) 32 5/16"(821)[2]					
		25CDH2072N	25CDH2472N	25CDH2872N	25CDH3272N	25CDH3672N

ELEVATION SYMBOL LEGEND:

VALUES IN () ARE IN MILLIMETER CONVERSIONS.

VALUES IN [] ARE NUMBER OF DAYLIGHT OPENINGS PER UNIT.

NUMBER INDICATES DESIGN PRESSURE (DP) RATING WITH STANDARD GLAZING.

NUMBER INDICATES OPTIONAL DESIGN PRESSURE (DP) RATING.

E1 UNITS WITH AN E1 EGRESS DESIGNATION MEET 5.0 SQ FT EGRESS WITH A DP35 SILL STOP, BUT NOT WITH A DP 50 SILL STOP.

E2 UNITS WITH AN E2 EGRESS DESIGNATION MEET 5.0 SQ FT EGRESS WITH EITHER A DP35 OR A DP 50 SILL STOP.

E3 UNITS WITH AN E3 EGRESS DESIGNATION MEET 5.7 SQ FT EGRESS WITH A DP35 SILL STOP, BUT NOT WITH A DP 50 SILL STOP.

E4 UNITS WITH AN E4 EGRESS DESIGNATION MEET 5.0 SQ FT EGRESS WITH EITHER A DP35 OR A DP 50 SILL STOP.

N INDICATES NOMINAL SIZING.

SCALE: 1/4" = 1'

SINGLE UNITS
WITH 15" TRANSOM

UNIT SIZE	28 1/8" (714)	32 1/8" (816)	36 1/8" (918)	40 1/8" (1019)
ROUGH OPENING	26 1/8" (664)	30 1/8" (765)	34 1/8" (867)	38 1/8" (968)
FRAME SIZE	25 3/8" (645)	29 3/8" (746)	33 3/8" (848)	37 3/8" (949)
DAYLIGHT OPENING	20 1/16" (510)	24 1/16" (611)	28 1/16" (716)	32 1/16" (814)

53 3/4" (1365) 51 3/4" (1314) 51" (1295) 14 11/16" (373/2) 10 1/4" (260)				
57 3/4" (1467) 55 3/4" (1416) 55" (1397) 16 11/16" (424/2) 10 1/4" (260)				
65 3/4" (1670) 63 3/4" (1619) 63" (1600) 20 11/16" (525/2) 10 1/4" (260)				
69 3/4" (1772) 67 3/4" (1721) 67" (1702) 22 11/16" (576/2) 10 1/4" (260)				
73 3/4" (1873) 71 3/4" (1822) 71" (1803) 24 11/16" (627/2) 10 1/4" (260)				
77 3/4" (1975) 75 3/4" (1924) 75" (1905) 26 11/16" (678/2) 10 1/4" (260)				
81 3/4" (2076) 79 3/4" (2026) 79" (2007) 27 11/16" (703/2) 10 1/4" (260)				
85 3/4" (2178) 83 3/4" (2127) 83" (2108) 30 11/16" (779/2) 10 1/4" (260)				

ELEVATION SYMBOL LEGEND:

VALUES IN () ARE IN MILLIMETER CONVERSIONS.
VALUES IN [] ARE NUMBER OF DAYLIGHT OPENINGS PER UNIT.

E UNIT MEETS EGRESS REQUIREMENTS FOR IRC CODE. STATE AND LOCAL EGRESS CODES MAY DIFFER. ALWAYS REFER TO LOCAL BUILDING CODES FOR COMPLETE REQUIREMENTS. CHECK WITH LOCAL OFFICIALS TO ENSURE COMPLIANCE BEFORE INSTALLING THE UNIT. SEE NOTES ON SINGLE UNIT ELEVATIONS FOR SPECIFIC EGRESS CAPABILITY.

SCALE: 1/8" = 1'

SINGLE UNITS
WITH 15" TRANSM

UNIT SIZE	28 1/8" (714)	32 1/8" (816)	36 1/8" (918)	40 1/8" (1019)
ROUGH OPENING	26 1/8" (664)	30 1/8" (765)	34 1/8" (867)	38 1/8" (968)
FRAME SIZE	25 3/8" (645)	29 3/8" (746)	33 3/8" (848)	37 3/8" (949)
DAYLIGHT OPENING	20 1/16" (510)	24 1/16" (611)	28 1/16" (716)	32 1/16" (814)

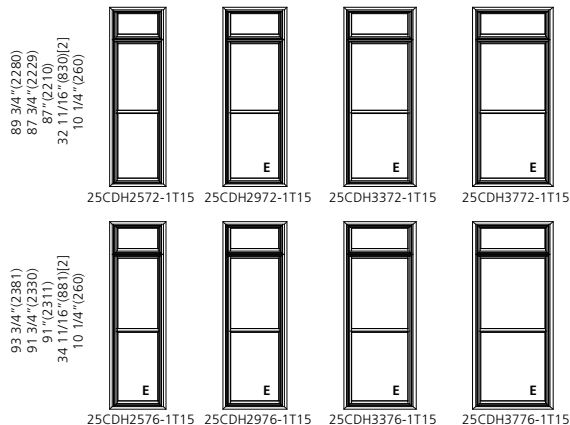

ELEVATION SYMBOL LEGEND:

VALUES IN () ARE IN MILLIMETER CONVERSIONS.
VALUES IN [] ARE NUMBER OF DAYLIGHT OPENINGS PER UNIT.

E UNIT MEETS EGRESS REQUIREMENTS FOR IRC CODE. STATE AND LOCAL EGRESS CODES MAY DIFFER. ALWAYS REFER TO LOCAL BUILDING CODES FOR COMPLETE REQUIREMENTS.
CHECK WITH LOCAL OFFICIALS TO ENSURE COMPLIANCE BEFORE INSTALLING THE UNIT.
SEE NOTES ON SINGLE UNIT ELEVATIONS FOR SPECIFIC EGRESS CAPABILITY.

SCALE: 1/8" = 1'

SINGLE UNITS
WITH 24" TRANSOM

UNIT SIZE	28 1/8" (714)	32 1/8" (816)	36 1/8" (918)	40 1/8" (1019)
ROUGH OPENING	26 1/8" (664)	30 1/8" (765)	34 1/8" (867)	38 1/8" (968)
FRAME SIZE	25 3/8" (645)	29 3/8" (746)	33 3/8" (848)	37 3/8" (949)
DAYLIGHT OPENING	20 1/16" (510)	24 1/16" (611)	28 1/16" (716)	32 1/16" (814)

62 3/4" (1594) 60 3/4" (1543) 14 1/16" (357) 19 1/4" (489)				
66 3/4" (1695) 64 3/4" (1645) 16 1/16" (420) 19 1/4" (489)				
74 3/4" (1899) 72 3/4" (1848) 17 1/16" (432) 19 1/4" (489)				
78 3/4" (2000) 76 3/4" (1949) 19 1/16" (489) 19 1/4" (489)				
82 3/4" (2102) 80 3/4" (2051) 19 1/16" (489) 19 1/4" (489)				
86 3/4" (2203) 84 3/4" (2153) 19 1/16" (489) 19 1/4" (489)				
90 3/4" (2305) 88 3/4" (2254) 19 1/16" (489) 19 1/4" (489)				

ELEVATION SYMBOL LEGEND:

VALUES IN () ARE IN MILLIMETER CONVERSIONS.
VALUES IN [] ARE NUMBER OF DAYLIGHT OPENINGS PER UNIT.

E UNIT MEETS EGRESS REQUIREMENTS FOR IRC CODE. STATE AND LOCAL EGRESS CODES MAY DIFFER. ALWAYS REFER TO LOCAL BUILDING CODES FOR COMPLETE REQUIREMENTS.
CHECK WITH LOCAL OFFICIALS TO ENSURE COMPLIANCE BEFORE INSTALLING THE UNIT.
SEE NOTES ON SINGLE UNIT ELEVATIONS FOR SPECIFIC EGRESS CAPABILITY.

SCALE: 1/8" = 1'

SINGLE UNITS
WITH 24" TRANSOM

UNIT SIZE	28 1/8" (714)	32 1/8" (816)	36 1/8" (918)	40 1/8" (1019)
ROUGH OPENING	26 1/8" (664)	30 1/8" (765)	34 1/8" (867)	38 1/8" (968)
FRAME SIZE	25 3/8" (645)	29 3/8" (746)	33 3/8" (848)	37 3/8" (949)
DAYLIGHT OPENING	20 1/16" (510)	24 1/16" (611)	28 1/16" (716)	32 1/16" (814)

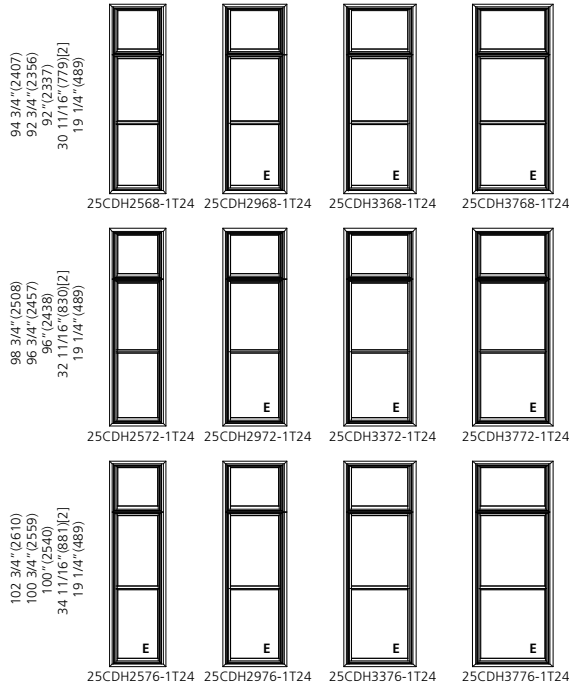

ELEVATION SYMBOL LEGEND:
VALUES IN () ARE IN MILLIMETER CONVERSIONS.
VALUES IN [] ARE NUMBER OF DAYLIGHT OPENINGS PER UNIT.

E UNIT MEETS EGRESS REQUIREMENTS FOR IRC CODE. STATE AND LOCAL EGRESS CODES MAY DIFFER. ALWAYS REFER TO LOCAL BUILDING CODES FOR COMPLETE REQUIREMENTS. CHECK WITH LOCAL OFFICIALS TO ENSURE COMPLIANCE BEFORE INSTALLING THE UNIT. SEE NOTES ON SINGLE UNIT ELEVATIONS FOR SPECIFIC EGRESS CAPABILITY.

SCALE: 1/8" = 1'

SINGLE UNITS - NOMINAL
WITH 18" TRANSOM

UNIT SIZE	22" (559)	26" (660)	30" (762)	38" (965)
ROUGH OPENING	20" (508)	24" (610)	28" (711)	36" (914)
FRAME SIZE	19 1/4" (489)	23 1/4" (591)	27 1/4" (692)	35 1/4" (895)
DAYLIGHT OPENING	13 15/16" (354)	17 15/16" (455)	21 15/16" (557)	29 15/16" (760)
56" (1422) 54" (1372) 53 1/4" (1353) 14 5/16" (364) [2] 13 1/4" (337)				
62" (1575) 60" (1524) 59 1/4" (1505) 17 5/16" (440) [2] 13 1/4" (337)				
68" (1727) 66" (1676) 65 1/4" (1657) 20 5/16" (515) [2] 13 1/4" (337)				
74" (1880) 72" (1829) 71 1/4" (1810) 23 5/16" (592) [2] 13 1/4" (337)				
80" (2032) 78" (1981) 77 1/4" (1962) 26 5/16" (668) [2] 13 1/4" (337)				
86" (2184) 84" (2134) 83 1/4" (2115) 29 5/16" (745) [2] 13 1/4" (337)				
92" (2337) 90" (2286) 89 1/4" (2267) 32 5/16" (821) [2] 13 1/4" (337)				

ELEVATION SYMBOL LEGEND:

VALUES IN () ARE IN MILLIMETER CONVERSIONS.

VALUES IN [] ARE NUMBER OF DAYLIGHT OPENINGS PER UNIT.

E UNIT MEETS EGRESS REQUIREMENTS FOR IRC CODE. STATE AND LOCAL EGRESS CODES MAY DIFFER. ALWAYS REFER TO LOCAL BUILDING CODES FOR COMPLETE REQUIREMENTS. CHECK WITH LOCAL OFFICIALS TO ENSURE COMPLIANCE BEFORE INSTALLING THE UNIT.

SEE NOTES ON SINGLE UNIT ELEVATIONS FOR SPECIFIC EGRESS CAPABILITY.

N INDICATES NOMINAL SIZING.

SCALE: 1/8" = 1'

TWIN UNITS

UNIT SIZE ROUGH OPENING FRAME SIZE DAYLIGHT OPENING	45 1/2" (1156) 43 1/2" (1105) 42 3/4" (1086) 16 1/16" (408)[2]	53 1/2" (1359) 51 1/2" (1308) 50 3/4" (1289) 20 1/16" (510)[2]	61 1/2" (1562) 59 1/2" (1511) 58 3/4" (1492) 24 1/16" (611)[2]	69 1/2" (1765) 67 1/2" (1715) 66 3/4" (1696) 28 1/16" (713)[2]	77 1/2" (1969) 75 1/2" (1918) 74 3/4" (1899) 32 1/16" (814)[2]	85 1/2" (2172) 83 1/2" (2121) 82 3/4" (2102) 36 1/16" (916)[2]
38 3/4" (984) 36 3/4" (933) 36" (914) 14 11/16" (373)[2]						
42 3/4" (1086) 40 3/4" (1035) 40" (1016) 16 11/16" (424)[2]						
50 3/4" (1289) 48 3/4" (1238) 48" (1219) 20 11/16" (525)[2]						
54 3/4" (1391) 52 3/4" (1340) 52" (1321) 22 11/16" (576)[2]						
58 3/4" (1492) 56 3/4" (1441) 56" (1422) 24 11/16" (627)[2]						
62 3/4" (1594) 60 3/4" (1543) 60" (1524) 26 11/16" (678)[2]						
66 3/4" (1695) 64 3/4" (1645) 64" (1626) 27 11/16" (703)[2]						
70 3/4" (1797) 68 3/4" (1746) 68" (1727) 30 11/16" (779)[2]						
74 3/4" (1899) 72 3/4" (1848) 72" (1829) 32 11/16" (830)[2]						
78 3/4" (2000) 76 3/4" (1949) 76" (1930) 34 11/16" (881)[2]						

ELEVATION SYMBOL LEGEND:

VALUES IN () ARE IN MILLIMETER CONVERSIONS.

VALUES IN [] ARE NUMBER OF DAYLIGHT OPENINGS PER UNIT.

E UNIT MEETS EGRESS REQUIREMENTS FOR IRC CODE. STATE AND LOCAL EGRESS CODES MAY DIFFER. ALWAYS REFER TO LOCAL BUILDING CODES FOR COMPLETE REQUIREMENTS. CHECK WITH LOCAL OFFICIALS TO ENSURE COMPLIANCE BEFORE INSTALLING THE UNIT. SEE NOTES ON SINGLE UNIT ELEVATIONS FOR SPECIFIC EGRESS CAPABILITY.

SCALE: 1/8" = 1'

TWIN UNITS - NOMINAL

UNIT SIZE ROUGH OPENING FRAME SIZE DAYLIGHT OPENING	42" (1067) 40" (1016) 39 1/4" (997) 13 15/16" (354) [2]	50" (1270) 48" (1219) 47 1/4" (1200) 17 15/16" (455) [2]	58" (1473) 56" (1422) 55 1/4" (1403) 21 15/16" (557) [2]	66" (1676) 64" (1626) 63 1/4" (1607) 25 15/16" (659) [2]	74" (1880) 72" (1829) 71 1/4" (1810) 29 15/16" (760) [2]
38" (965) 36" (914) 35 1/4" (895) 14 5/16" (364) [2]					
44" (1118) 42" (1067) 41 1/4" (1048) 17 5/16" (440) [2]					
50" (1270) 48" (1219) 47 1/4" (1200) 20 5/16" (515) [2]					
56" (1422) 54" (1372) 53 1/4" (1353) 23 5/16" (592) [2]					
62" (1575) 60" (1524) 59 1/4" (1505) 26 5/16" (668) [2]					
68" (1727) 66" (1676) 65 1/4" (1657) 29 5/16" (745) [2]					
74" (1880) 72" (1829) 71 1/4" (1810) 32 5/16" (821) [2]					

ELEVATION SYMBOL LEGEND:

VALUES IN () ARE IN MILLIMETER CONVERSIONS.

VALUES IN [] ARE NUMBER OF DAYLIGHT OPENINGS PER UNIT.

E UNIT MEETS EGRESS REQUIREMENTS FOR IRC CODE. STATE AND LOCAL EGRESS CODES MAY DIFFER. ALWAYS REFER TO LOCAL BUILDING CODES FOR COMPLETE REQUIREMENTS. CHECK WITH LOCAL OFFICIALS TO ENSURE COMPLIANCE BEFORE INSTALLING THE UNIT. SEE NOTES ON SINGLE UNIT ELEVATIONS FOR SPECIFIC EGRESS CAPABILITY.

N INDICATES NOMINAL SIZING.

SCALE: 1/8" = 1'

TWIN UNITS
WITH 15" TRANSOM

UNIT SIZE ROUGH OPENING FRAME SIZE DAYLIGHT OPENING	53 1/2" (1259) 51 1/2" (1308) 50 3/4" (1289) 20 1/16" (510)[2]	61 1/2" (1562) 59 1/2" (1511) 58 3/4" (1492) 24 1/16" (611)[2]	69 1/2" (1765) 67 1/2" (1715) 66 3/4" (1695) 28 1/16" (716)[2]	77 1/2" (1969) 75 1/2" (1918) 74 3/4" (1899) 32 1/16" (814)[2]
53 3/4" (1365) 51 3/4" (1314) 51" (1295) 14 11/16" (373)[2] 10 1/4" (260)				
57 3/4" (1467) 55 3/4" (1416) 55" (1397) 16 11/16" (424)[2] 10 1/4" (260)				
65 3/4" (1670) 63 3/4" (1619) 63" (1600) 20 11/16" (525)[2] 10 1/4" (260)				
69 3/4" (1772) 67 3/4" (1721) 67" (1702) 22 11/16" (576)[2] 10 1/4" (260)				
73 3/4" (1873) 71 3/4" (1822) 71" (1803) 24 11/16" (627)[2] 10 1/4" (260)				
77 3/4" (1975) 75 3/4" (1924) 75" (1905) 26 11/16" (678)[2] 10 1/4" (260)				
81 3/4" (2076) 79 3/4" (2026) 79" (2007) 27 11/16" (703)[2] 10 1/4" (260)				
85 3/4" (2178) 83 3/4" (2127) 83" (2108) 30 11/16" (779)[2] 10 1/4" (260)				

ELEVATION SYMBOL LEGEND:
VALUES IN () ARE IN MILLIMETER CONVERSIONS.
VALUES IN [] ARE NUMBER OF DAYLIGHT OPENINGS PER UNIT.

E UNIT MEETS EGRESS REQUIREMENTS FOR IRC CODE. STATE AND LOCAL EGRESS CODES MAY DIFFER. ALWAYS REFER TO LOCAL BUILDING CODES FOR COMPLETE REQUIREMENTS.
CHECK WITH LOCAL OFFICIALS TO ENSURE COMPLIANCE BEFORE INSTALLING THE UNIT.
SEE NOTES ON SINGLE UNIT ELEVATIONS FOR SPECIFIC EGRESS CAPABILITY.

SCALE: 1/8" = 1'

TWIN UNITS
WITH 15" TRANSOM

UNIT SIZE	53 1/2" (1259)	61 1/2" (1562)	69 1/2" (1765)	77 1/2" (1969)
ROUGH OPENING	51 1/2" (1308)	59 1/2" (1511)	67 1/2" (1715)	75 1/2" (1918)
FRAME SIZE	50 3/4" (1289)	58 3/4" (1492)	66 3/4" (1695)	74 3/4" (1899)
DAYLIGHT OPENING	20 1/16" (510)[2]	24 1/16" (611)[2]	28 1/16" (716)[2]	32 1/16" (814)[2]

89 3/4" (2280)
87 3/4" (2229)
87" (2210)
32 11/16" (830)[2]
10 1/4" (260)

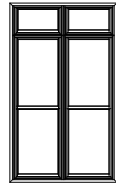

25CDH2572-2A15

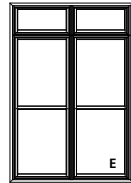

25CDH2972-2A15

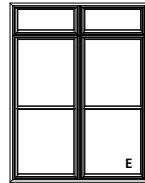

25CDH3372-2A15

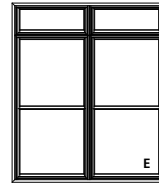

25CDH3772-2A15

93 3/4" (2381)
91 3/4" (2330)
91" (2311)
34 11/16" (881)[2]
10 1/4" (260)

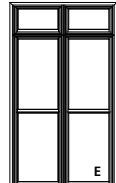

25CDH2576-2A15

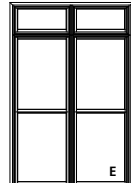

25CDH2976-2A15

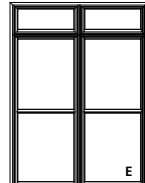

25CDH3376-2A15

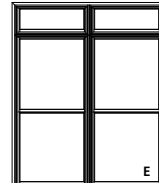

25CDH3776-2A15

ELEVATION SYMBOL LEGEND:

VALUES IN () ARE IN MILLIMETER CONVERSIONS.

VALUES IN [] ARE NUMBER OF DAYLIGHT OPENINGS PER UNIT.

E UNIT MEETS EGRESS REQUIREMENTS FOR IRC CODE. STATE AND LOCAL EGRESS CODES MAY DIFFER. ALWAYS REFER TO LOCAL BUILDING CODES FOR COMPLETE REQUIREMENTS. CHECK WITH LOCAL OFFICIALS TO ENSURE COMPLIANCE BEFORE INSTALLING THE UNIT. SEE NOTES ON SINGLE UNIT ELEVATIONS FOR SPECIFIC EGRESS CAPABILITY.

SCALE: 1/8" = 1'

TWIN UNITS WITH 24" TRANSOM

UNIT SIZE ROUGH OPENING FRAME SIZE DAYLIGHT OPENING	53 1/2" (1259) 51 1/2" (1308) 50 3/4" (1289) 20 1/16" (510)[2]	61 1/2" (1562) 59 1/2" (1511) 58 3/4" (1492) 24 1/16" (611)[2]	69 1/2" (1765) 67 1/2" (1715) 66 3/4" (1695) 28 1/16" (716)[2]	77 1/2" (1969) 75 1/2" (1918) 74 3/4" (1899) 32 1/16" (814)[2]
62 3/4" (1594) 60 3/4" (1543) 60" (1524) 14 11/16" (373)[2] 19 1/4" (489)				
66 3/4" (1695) 64 3/4" (1645) 64" (1626) 16 11/16" (424)[2] 19 1/4" (489)				
74 3/4" (1899) 72 3/4" (1848) 72" (1829) 20 11/16" (525)[2] 19 1/4" (489)				
78 3/4" (2000) 76 3/4" (1949) 76" (1930) 22 11/16" (576)[2] 19 1/4" (489)				
82 3/4" (2102) 80 3/4" (2051) 80" (2032) 24 11/16" (627)[2] 19 1/4" (489)				
86 3/4" (2203) 84 3/4" (2153) 84" (2134) 26 11/16" (678)[2] 19 1/4" (489)				
90 3/4" (2305) 88 3/4" (2254) 88" (2235) 27 11/16" (703)[2] 19 1/4" (489)				

ELEVATION SYMBOL LEGEND:

VALUES IN () ARE IN MILLIMETER CONVERSIONS.

VALUES IN [] ARE NUMBER OF DAYLIGHT OPENINGS PER UNIT.

E UNIT MEETS EGRESS REQUIREMENTS FOR IRC CODE. STATE AND LOCAL EGRESS CODES MAY DIFFER. ALWAYS REFER TO LOCAL BUILDING CODES FOR COMPLETE REQUIREMENTS. CHECK WITH LOCAL OFFICIALS TO ENSURE COMPLIANCE BEFORE INSTALLING THE UNIT. SEE NOTES ON SINGLE UNIT ELEVATIONS FOR SPECIFIC EGRESS CAPABILITY.

SCALE: 1/8" = 1'

TWIN UNITS
WITH 24" TRANSOM

UNIT SIZE	53 1/2" (1259)	61 1/2" (1562)	69 1/2" (1765)	77 1/2" (1969)
ROUGH OPENING	51 1/2" (1308)	59 1/2" (1511)	67 1/2" (1715)	75 1/2" (1918)
FRAME SIZE	50 3/4" (1289)	58 3/4" (1492)	66 3/4" (1695)	74 3/4" (1899)
DAYLIGHT OPENING	20 1/16" (510)[2]	24 1/16" (611)[2]	28 1/16" (716)[2]	32 1/16" (814)[2]

94 3/4" (2407) 92 3/4" (2356) 92" (2337) 30 11/16" (779)[2] 19 1/4" (489)				
	25CDH2568-2A24	25CDH2968-2A24	25CDH3368-2A24	25CDH3768-2A24
98 3/4" (2508) 96 3/4" (2457) 96" (2438) 32 11/16" (830)[2] 19 1/4" (489)				
	25CDH2572-2A24	25CDH2972-2A24	25CDH3372-2A24	25CDH3772-2A24
102 3/4" (2610) 100 3/4" (2559) 100" (2540) 34 11/16" (881)[2] 19 1/4" (489)				
	25CDH2576-2A24	25CDH2976-2A24	25CDH3376-2A24	25CDH3776-2A24

ELEVATION SYMBOL LEGEND:

VALUES IN () ARE IN MILLIMETER CONVERSIONS.

VALUES IN [] ARE NUMBER OF DAYLIGHT OPENINGS PER UNIT.

E UNIT MEETS EGRESS REQUIREMENTS FOR IRC CODE. STATE AND LOCAL EGRESS CODES MAY DIFFER. ALWAYS REFER TO LOCAL BUILDING CODES FOR COMPLETE REQUIREMENTS. CHECK WITH LOCAL OFFICIALS TO ENSURE COMPLIANCE BEFORE INSTALLING THE UNIT. SEE NOTES ON SINGLE UNIT ELEVATIONS FOR SPECIFIC EGRESS CAPABILITY.

SCALE: 1/8" = 1'

TWIN UNITS - NOMINAL WITH 18" TRANSM

UNIT SIZE	42" (1067)	50" (1270)	58" (1473)	74" (1880)
ROUGH OPENING	40" (1016)	48" (1219)	56" (1422)	72" (1829)
FRAME SIZE	39 1/4" (997)	47 1/4" (1200)	55 1/4" (1403)	71 1/4" (1810)
DAYLIGHT OPENING	13 15/16" (354)[2]	17 15/16" (455)[2]	21 15/16" (557)[2]	29 15/16" (760)[2]
56" (1422) 54" (1372) 53 1/4" (1353) 14 5/16" (364)[2] 13 1/4" (337)				
62" (1575) 60" (1524) 59 1/4" (1505) 17 5/16" (440)[2] 13 1/4" (337)				
68" (1727) 66" (1676) 65 1/4" (1657) 20 5/16" (515)[2] 13 1/4" (337)				
74" (1880) 72" (1829) 71 1/4" (1810) 23 5/16" (592)[2] 13 1/4" (337)				
80" (2032) 78" (1981) 77 1/4" (1962) 26 5/16" (668)[2] 13 1/4" (337)				
86" (2184) 84" (2134) 83 1/4" (2115) 29 5/16" (745)[2] 13 1/4" (337)				
92" (2337) 90" (2286) 89 1/4" (2267) 32 5/16" (821)[2] 13 1/4" (337)				

ELEVATION SYMBOL LEGEND:

VALUES IN () ARE IN MILLIMETER CONVERSIONS.

VALUES IN [] ARE NUMBER OF DAYLIGHT OPENINGS PER UNIT.

E UNIT MEETS EGRESS REQUIREMENTS FOR IRC CODE. STATE AND LOCAL EGRESS CODES MAY DIFFER. ALWAYS REFER TO LOCAL BUILDING CODES FOR COMPLETE REQUIREMENTS. CHECK WITH LOCAL OFFICIALS TO ENSURE COMPLIANCE BEFORE INSTALLING THE UNIT. SEE NOTES ON SINGLE UNIT ELEVATIONS FOR SPECIFIC EGRESS CAPABILITY.

N INDICATES NOMINAL SIZING.

SCALE: 1/8" = 1'

TRIPLE UNITS

UNIT SIZE ROUGH OPENING FRAME SIZE DAYLIGHT OPENING	66 7/8" (1699) 64 7/8" (1648) 64 1/8" (1629) 16 1/16" (408)[3]	78 7/8" (2003) 76 7/8" (1953) 76 1/8" (1934) 20 1/16" (510)[3]	90 7/8" (2308) 88 7/8" (2257) 88 1/8" (2238) 24 1/16" (611)[3]	102 7/8" (2613) 100 7/8" (2562) 100 1/8" (2543) 28 1/16" (713)[3]	114 7/8" (2918) 112 7/8" (2867) 112 1/8" (2848) 32 1/16" (814)[3]
38 3/4" (984) 36 3/4" (933) 36" (914) 14 11/16" (373)[2]					
42 3/4" (1086) 40 3/4" (1035) 40" (1016) 16 11/16" (424)[2]					
50 3/4" (1289) 48 3/4" (1238) 48" (1219) 20 11/16" (525)[2]					
54 3/4" (1391) 52 3/4" (1340) 52" (1321) 22 11/16" (576)[2]					
58 3/4" (1492) 56 3/4" (1441) 56" (1421) 24 11/16" (627)[2]					
62 3/4" (1594) 60 3/4" (1543) 60" (1524) 26 11/16" (678)[2]					
66 3/4" (1695) 64 3/4" (1645) 64" (1626) 27 11/16" (703)[2]					
70 3/4" (1797) 68 3/4" (1746) 68" (1727) 30 11/16" (779)[2]					
74 3/4" (1899) 72 3/4" (1848) 72" (1829) 32 11/16" (830)[2]					
78 3/4" (2000) 76 3/4" (1949) 76" (1930) 34 11/16" (881)[2]					

ELEVATION SYMBOL LEGEND:







VALUES IN () ARE IN MILLIMETER CONVERSIONS.

VALUES IN [] ARE NUMBER OF DAYLIGHT OPENINGS PER UNIT.

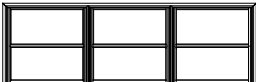
E UNIT MEETS EGRESS REQUIREMENTS FOR IRC CODE. STATE AND LOCAL EGRESS CODES MAY DIFFER. ALWAYS REFER TO LOCAL BUILDING CODES FOR COMPLETE REQUIREMENTS. CHECK WITH LOCAL OFFICIALS TO ENSURE COMPLIANCE BEFORE INSTALLING THE UNIT. SEE NOTES ON SINGLE UNIT ELEVATIONS FOR SPECIFIC EGRESS CAPABILITY.

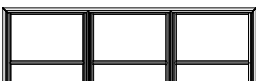
SCALE: 1/8" = 1'

TRIPLE UNITS

UNIT SIZE	ROUGH OPENING	FRAME SIZE	DAYLIGHT OPENING	
				126 7/8" (3223) 124 7/8" (3172) 124 1/8" (3153) 36 1/16" (916) [3]
38 3/4" (984)	36 3/4" (933)	36 (914)	14 11/16" (373) [2]	 25CDH4136-3
42 3/4" (1086)	40 3/4" (1035)	40 (1016)	16 11/16" (429) [2]	 25CDH4140-3
50 3/4" (1289)	48 3/4" (1238)	48 (1219)	20 11/16" (529) [2]	 25CDH4148-3
54 3/4" (1391)	52 3/4" (1340)	52 (1321)	22 11/16" (576) [2]	 25CDH4152-3
58 3/4" (1492)	56 3/4" (1441)	56 (1422)	24 11/16" (627) [2]	 25CDH4156-3
62 3/4" (1594)	60 3/4" (1543)	60 (1524)	26 11/16" (678) [2]	 25CDH4160-3
66 3/4" (1695)	64 3/4" (1645)	64 (1626)	27 11/16" (703) [2]	 25CDH4164-3

ELEVATION SYMBOL LEGEND:

VALUES IN () ARE IN MILLIMETER CONVERSIONS.

VALUES IN [] ARE NUMBER OF DAYLIGHT OPENINGS PER UNIT.

E UNIT MEETS EGRESS REQUIREMENTS FOR IRC CODE. STATE AND LOCAL EGRESS CODES MAY DIFFER. ALWAYS REFER TO LOCAL BUILDING CODES FOR COMPLETE REQUIREMENTS. CHECK WITH LOCAL OFFICIALS TO ENSURE COMPLIANCE BEFORE INSTALLING THE UNIT. SEE NOTES ON SINGLE UNIT ELEVATIONS FOR SPECIFIC EGRESS CAPABILITY.

SCALE: 1/8" = 1'

TRIPLE UNITS - NOMINAL

UNIT SIZE ROUGH OPENING FRAME SIZE DAYLIGHT OPENING	62"(1575) 60"(1524) 59 1/4"(1505) 13 15/16"(354)[3]	74"(1880) 72"(1829) 71 1/4"(1810) 17 15/16"(455)[3]	86"(2184) 84"(2134) 83 1/4"(2115) 21 15/16"(557)[3]	98"(2489) 96"(2438) 95 1/4"(2419) 25 15/16"(659)[3]	110"(2794) 108"(2743) 107 1/4"(2724) 29 15/16"(760)[3]
38"(965) 36"(914) 35 1/4"(895) 14 5/16"(364)[2]					
44"(1118) 42"(1067) 41 1/4"(1048) 17 5/16"(440)[2]					
50"(1270) 48"(1219) 47 1/4"(1200) 20 5/16"(515)[2]					
56"(1422) 54"(1372) 53 1/4"(1353) 23 5/16"(592)[2]					
62"(1575) 60"(1524) 59 1/4"(1505) 26 5/16"(668)[2]					
68"(1727) 66"(1676) 65 1/4"(1657) 29 5/16"(745)[2]					
74"(1880) 72"(1829) 71 1/4"(1810) 32 5/16"(821)[2]					

ELEVATION SYMBOL LEGEND:

VALUES IN () ARE IN MILLIMETER CONVERSIONS.

VALUES IN [] ARE NUMBER OF DAYLIGHT OPENINGS PER UNIT.

E UNIT MEETS EGRESS REQUIREMENTS FOR IRC CODE. STATE AND LOCAL EGRESS CODES MAY DIFFER. ALWAYS REFER TO LOCAL BUILDING CODES FOR COMPLETE REQUIREMENTS. CHECK WITH LOCAL OFFICIALS TO ENSURE COMPLIANCE BEFORE INSTALLING THE UNIT. SEE NOTES ON SINGLE UNIT ELEVATIONS FOR SPECIFIC EGRESS CAPABILITY.

N INDICATES NOMINAL SIZING.

SCALE: 1/8" = 1'

TRIPLE UNITS WITH 15" TRANSM

UNIT SIZE
ROUGH OPENING
FRAME SIZE
DAYLIGHT OPENING

78 7/8" (2003)
76 7/8" (1953)
76 1/8" (1934)
20 1/16" (510) [3]

90 7/8" (2308)
88 7/8" (2257)
88 1/8" (2238)
24 1/16" (611) [3]

102 7/8" (2613)
100 7/8" (2562)
100 1/8" (2543)
28 1/16" (716) [3]

114 7/8" (2918)
112 7/8" (2867)
112 1/8" (2848)
32 1/16" (814) [3]

53 3/4" (1365)
51 3/4" (1314)
51" (1295)
14 1/16" (373) [2]
10 1/4" (260)



25CDH2536-3A15



25CDH2936-3A15



25CDH3336-3A15



25CDH3736-3A15

57 3/4" (1467)
55 3/4" (1416)
55" (1397)
16 1/16" (424) [2]
10 1/4" (260)



25CDH2540-3A15



25CDH2940-3A15



25CDH3340-3A15



25CDH3740-3A15

65 3/4" (1670)
63 3/4" (1619)
63" (1600)
20 1/16" (525) [2]
10 1/4" (260)



25CDH2548-3A15



25CDH2948-3A15



25CDH3348-3A15



25CDH3748-3A15

69 3/4" (1772)
67 3/4" (1721)
67" (1702)
22 1/16" (576) [2]
10 1/4" (260)



25CDH2552-3A15



25CDH2952-3A15



25CDH3352-3A15



25CDH3752-3A15

73 3/4" (1873)
71 3/4" (1822)
71" (1803)
24 1/16" (627) [2]
10 1/4" (260)



25CDH2556-3A15



25CDH2956-3A15



25CDH3356-3A15



25CDH3756-3A15

77 3/4" (1975)
75 3/4" (1924)
75" (1905)
26 1/16" (678) [2]
10 1/4" (260)



25CDH2560-3A15



25CDH2960-3A15



25CDH3360-3A15



25CDH3760-3A15

81 3/4" (2076)
79 3/4" (2026)
79" (2007)
27 1/16" (703) [2]
10 1/4" (260)



25CDH2564-3A15



25CDH2964-3A15



25CDH3364-3A15



25CDH3764-3A15

85 3/4" (2178)
83 3/4" (2127)
83" (2108)
30 1/16" (779) [2]
10 1/4" (260)



25CDH2568-3A15



25CDH2968-3A15



25CDH3368-3A15



25CDH3768-3A15

ELEVATION SYMBOL LEGEND:

VALUES IN () ARE IN MILLIMETER CONVERSIONS.

VALUES IN [] ARE NUMBER OF DAYLIGHT OPENINGS PER UNIT.

E UNIT MEETS EGRESS REQUIREMENTS FOR IRC CODE. STATE AND LOCAL EGRESS CODES MAY DIFFER. ALWAYS REFER TO LOCAL BUILDING CODES FOR COMPLETE REQUIREMENTS.

CHECK WITH LOCAL OFFICIALS TO ENSURE COMPLIANCE BEFORE INSTALLING THE UNIT.

SEE NOTES ON SINGLE UNIT ELEVATIONS FOR SPECIFIC EGRESS CAPABILITY.

SCALE: 1/8" = 1'

**TRIPLE UNITS
WITH 15" TRANSOM**

UNIT SIZE	78 7/8" (2003)	90 7/8" (2308)	102 7/8" (2613)	114 7/8" (2918)
ROUGH OPENING	76 7/8" (1953)	88 7/8" (2257)	100 7/8" (2562)	112 7/8" (2867)
FRAME SIZE	76 1/8" (1934)	88 1/8" (2238)	100 1/8" (2543)	112 1/8" (2848)
DAYLIGHT OPENING	20 1/16" (510)[3]	24 1/16" (611)[3]	28 1/16" (716)[3]	32 1/16" (814)[3]

89 3/4" (2280)
87 3/4" (2229)
87" (2210)
32 11/16" (830)[2]
10 1/4" (260)

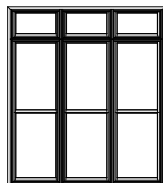

25CDH2572-3A15

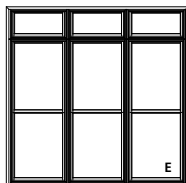

25CDH2972-3A15

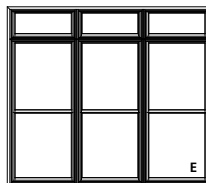

25CDH3372-3A15

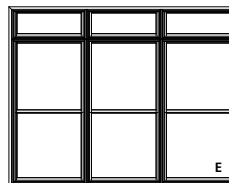

25CDH3772-3A15

93 3/4" (2381)
91 3/4" (2330)
91" (2311)
34 11/16" (881)[2]
10 1/4" (260)

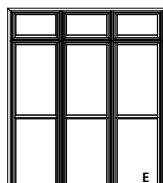

25CDH2576-3A15

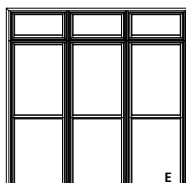

25CDH2976-3A15

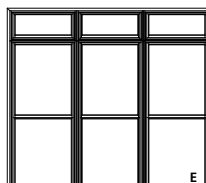

25CDH3376-3A15

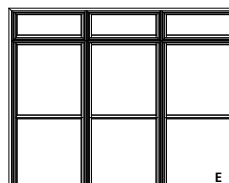

25CDH3776-3A15

ELEVATION SYMBOL LEGEND:

VALUES IN () ARE IN MILLIMETER CONVERSIONS.

VALUES IN [] ARE NUMBER OF DAYLIGHT OPENINGS PER UNIT.

E UNIT MEETS EGRESS REQUIREMENTS FOR IRC CODE. STATE AND LOCAL EGRESS CODES MAY DIFFER. ALWAYS REFER TO LOCAL BUILDING CODES FOR COMPLETE REQUIREMENTS. CHECK WITH LOCAL OFFICIALS TO ENSURE COMPLIANCE BEFORE INSTALLING THE UNIT. SEE NOTES ON SINGLE UNIT ELEVATIONS FOR SPECIFIC EGRESS CAPABILITY.

SCALE: 1/8" = 1'

TRIPLE UNITS WITH 24" TRANSOM

UNIT SIZE
ROUGH OPENING
FRAME SIZE
DAYLIGHT OPENING

78 7/8" (2003)
76 7/8" (1953)
76 1/8" (1934)
20 1/16" (510) [3]

90 7/8" (2308)
88 7/8" (2257)
88 1/8" (2238)
24 1/16" (611) [3]

102 7/8" (2613)
100 7/8" (2562)
100 1/8" (2543)
28 1/16" (716) [3]

114 7/8" (2918)
112 7/8" (2867)
112 1/8" (2848)
32 1/16" (814) [3]

62 3/4" (1594)
60 3/4" (1543)
60" (1524)
14 11/16" (373) [2]
19 1/4" (489)

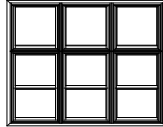

25CDH2536-3A24

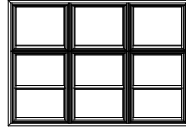

25CDH2936-3A24

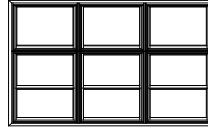

25CDH3336-3A24

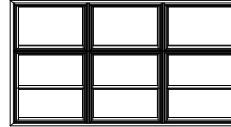

25CDH3736-3A24

66 3/4" (1695)
64 3/4" (1645)
64" (1626)
16 11/16" (424) [2]
19 1/4" (489)

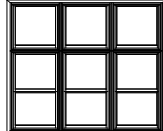

25CDH2540-3A24

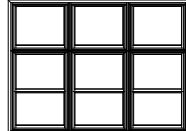

25CDH2940-3A24

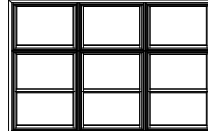

25CDH3340-3A24

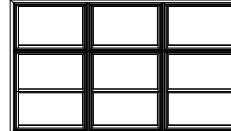

25CDH3740-3A24

74 3/4" (1899)
72 3/4" (1848)
72" (1829)
20 11/16" (525) [2]
19 1/4" (489)

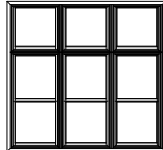

25CDH2548-3A24

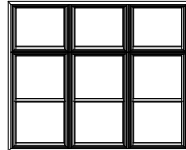

25CDH2948-3A24

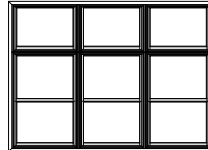

25CDH3348-3A24

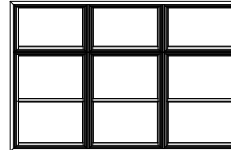

25CDH3748-3A24

78 3/4" (2000)
76 3/4" (1949)
76" (1930)
22 11/16" (576) [2]
19 1/4" (489)

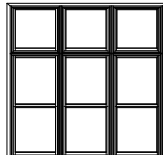

25CDH2552-3A24

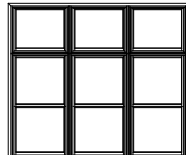

25CDH2952-3A24

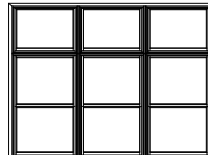

25CDH3352-3A24

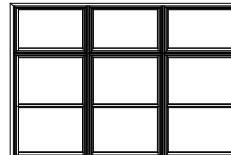

25CDH3752-3A24

82 3/4" (2102)
80 3/4" (2051)
80" (2032)
24 11/16" (627) [2]
19 1/4" (489)

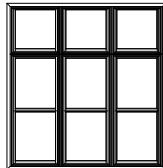

25CDH2556-3A24

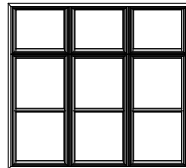

25CDH2956-3A24

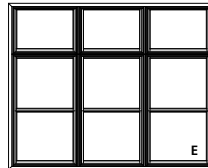

25CDH3356-3A24

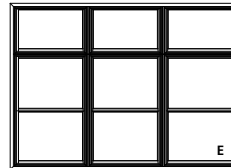

25CDH3756-3A24

86 3/4" (2203)
84 3/4" (2153)
84" (2134)
26 11/16" (678) [2]
19 1/4" (489)

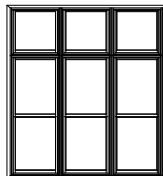

25CDH2560-3A24

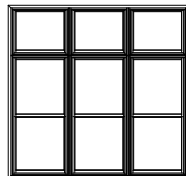

25CDH2960-3A24

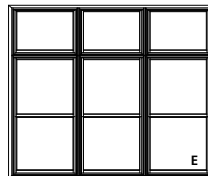

25CDH3360-3A24

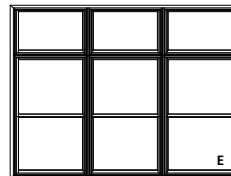

25CDH3760-3A24

90 3/4" (2305)
88 3/4" (2254)
88" (2235)
27 11/16" (703) [2]
19 1/4" (489)

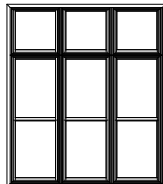

25CDH2564-3A24

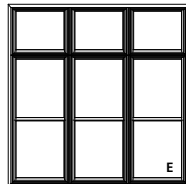

25CDH2964-3A24

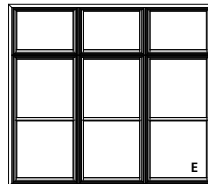

25CDH3364-3A24

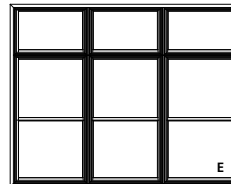

25CDH3764-3A24

ELEVATION SYMBOL LEGEND:

VALUES IN () ARE IN MILLIMETER CONVERSIONS.

VALUES IN [] ARE NUMBER OF DAYLIGHT OPENINGS PER UNIT.

E UNIT MEETS EGRESS REQUIREMENTS FOR IRC CODE. STATE AND LOCAL EGRESS CODES MAY DIFFER. ALWAYS REFER TO LOCAL BUILDING CODES FOR COMPLETE REQUIREMENTS. CHECK WITH LOCAL OFFICIALS TO ENSURE COMPLIANCE BEFORE INSTALLING THE UNIT. SEE NOTES ON SINGLE UNIT ELEVATIONS FOR SPECIFIC EGRESS CAPABILITY.

SCALE: 1/8" = 1'

TRIPLE UNITS
WITH 24" TRANSOM

UNIT SIZE
ROUGH OPENING
FRAME SIZE
DAYLIGHT OPENING

78 7/8" (2003)
76 7/8" (1953)
76 1/8" (1934)
20 1/16" (510)[3]

90 7/8" (2308)
88 7/8" (2257)
88 1/8" (2238)
24 1/16" (611)[3]

102 7/8" (2613)
100 7/8" (2562)
100 1/8" (2543)
28 1/16" (716)[3]

114 7/8" (2918)
112 7/8" (2867)
112 1/8" (2848)
32 1/16" (814)[3]

94 3/4" (2407) 92 3/4" (2356) 92 (2337) 30 1/16" (769)[2] 19 1/4" (489)				
98 3/4" (2508) 96 3/4" (2457) 96 (2438) 32 1/16" (813)[2] 19 1/4" (489)				
102 3/4" (2610) 100 3/4" (2559) 100 (2540) 34 1/16" (863)[2] 19 1/4" (489)				

ELEVATION SYMBOL LEGEND:

VALUES IN () ARE IN MILLIMETER CONVERSIONS.

VALUES IN [] ARE NUMBER OF DAYLIGHT OPENINGS PER UNIT.

E UNIT MEETS EGRESS REQUIREMENTS FOR IRC CODE. STATE AND LOCAL EGRESS CODES MAY DIFFER. ALWAYS REFER TO LOCAL BUILDING CODES FOR COMPLETE REQUIREMENTS. CHECK WITH LOCAL OFFICIALS TO ENSURE COMPLIANCE BEFORE INSTALLING THE UNIT. SEE NOTES ON SINGLE UNIT ELEVATIONS FOR SPECIFIC EGRESS CAPABILITY.

SCALE: 1/8" = 1'

TRIPLE UNITS - NOMINAL WITH 18" TRANSM

UNIT SIZE ROUGH OPENING FRAME SIZE DAYLIGHT OPENING	62"(1575) 60"(1524) 59 1/4"(1505) 13 15/16"(354)[3]	74"(1880) 72"(1829) 71 1/4"(1810) 17 15/16"(455)[3]	86"(2184) 84"(2134) 83 1/4"(2115) 21 15/16"(557)[3]	110"(2794) 108"(2743) 107 1/4"(2724) 29 15/16"(760)[3]
56"(1422) 54"(1372) 53 1/4"(1353) 14 5/16"(364)[2] 13 1/4"(337)				
62"(1575) 60"(1524) 59 1/4"(1505) 17 5/16"(440)[2] 13 1/4"(337)				
68"(1727) 66"(1676) 65 1/4"(1657) 20 5/16"(515)[2] 13 1/4"(337)				
74"(1880) 72"(1829) 71 1/4"(1810) 23 5/16"(592)[2] 13 1/4"(337)				
80"(2032) 78"(1981) 77 1/4"(1962) 26 5/16"(668)[2] 13 1/4"(337)				
86"(2184) 84"(2134) 83 1/4"(2115) 29 5/16"(745)[2] 13 1/4"(337)				
92"(2337) 90"(2286) 89 1/4"(2267) 32 5/16"(821)[2] 13 1/4"(337)				

ELEVATION SYMBOL LEGEND:

VALUES IN () ARE IN MILLIMETER CONVERSIONS.

VALUES IN [] ARE NUMBER OF DAYLIGHT OPENINGS PER UNIT.

E UNIT MEETS EGRESS REQUIREMENTS FOR IRC CODE. STATE AND LOCAL EGRESS CODES MAY DIFFER. ALWAYS REFER TO LOCAL BUILDING CODES FOR COMPLETE REQUIREMENTS. CHECK WITH LOCAL OFFICIALS TO ENSURE COMPLIANCE BEFORE INSTALLING THE UNIT. SEE NOTES ON SINGLE UNIT ELEVATIONS FOR SPECIFIC EGRESS CAPABILITY.

N INDICATES NOMINAL SIZING.

SCALE: 1/8" = 1'

4 WIDE UNITS

UNIT SIZE
ROUGH OPENING
FRAME SIZE
DAYLIGHT OPENING

88 1/4" (2242)
86 1/4" (2191)
85 1/2" (2172)
16 1/16" (408)[4]

104 1/4" (2648)
102 1/4" (2597)
101 1/2" (2578)
20 1/16" (510)[4]

120 1/4" (3054)
118 1/4" (3004)
117 1/2" (2985)
24 1/16" (611)[4]

136 1/4" (3461)
134 1/4" (3410)
133 1/2" (3391)
28 1/16" (713)[4]

38 3/4" (984) 36 3/4" (933) 36" (914) 14 11/16" (373)[2]				
42 3/4" (1086) 40 3/4" (1035) 40" (1016) 16 11/16" (428)[2]				
50 3/4" (1289) 48 3/4" (1238) 48" (1219) 20 11/16" (525)[2]				
54 3/4" (1391) 52 3/4" (1340) 52" (1321) 22 11/16" (576)[2]				
58 3/4" (1492) 56 3/4" (1441) 56" (1422) 24 11/16" (627)[2]				
62 3/4" (1594) 60 3/4" (1543) 60" (1524) 26 11/16" (678)[2]				
66 3/4" (1695) 64 3/4" (1645) 64" (1626) 27 11/16" (703)[2]				
70 3/4" (1797) 68 3/4" (1746) 68" (1727) 30 11/16" (779)[2]				
74 3/4" (1899) 72 3/4" (1848) 72" (1829) 32 11/16" (830)[2]				
78 3/4" (2000) 76 3/4" (1949) 76" (1930) 34 11/16" (881)[2]				

ELEVATION SYMBOL LEGEND:

VALUES IN () ARE IN MILLIMETER CONVERSIONS.

VALUES IN [] ARE NUMBER OF DAYLIGHT OPENINGS PER UNIT.

E UNIT MEETS EGRESS REQUIREMENTS FOR IRC CODE. STATE AND LOCAL EGRESS CODES MAY DIFFER. ALWAYS REFER TO LOCAL BUILDING CODES FOR COMPLETE REQUIREMENTS.

CHECK WITH LOCAL OFFICIALS TO ENSURE COMPLIANCE BEFORE INSTALLING THE UNIT.

SEE NOTES ON SINGLE UNIT ELEVATIONS FOR SPECIFIC EGRESS CAPABILITY.

SCALE: 1/8" = 1'

4 WIDE UNITS

UNIT SIZE	152 1/4" (3867)
ROUGH OPENING	150 1/4" (3816)
FRAME SIZE	149 1/2" (3797)
DAYLIGHT OPENING	32 1/16" (814)[4]

38 3/4" (984)	
36 3/4" (933)	
36" (914)	
14 11/16" (373)[2]	
	25CDH3736-4

42 3/4" (1086)	
40 3/4" (1035)	
40" (1016)	
16 11/16" (424)[2]	
	25CDH3740-4

50 3/4" (1289)	
48 3/4" (1238)	
48" (1219)	
20 11/16" (525)[2]	
	25CDH3748-4

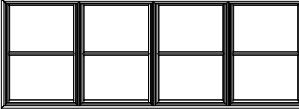
54 3/4" (1391)	
52 3/4" (1340)	
52" (1321)	
22 11/16" (576)[2]	
	25CDH3752-4

58 3/4" (1492)	
56 3/4" (1441)	
56" (1421)	
24 11/16" (627)[2]	
	25CDH3756-4

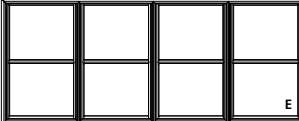
62 3/4" (1594)	
60 3/4" (1543)	
60" (1523)	
26 11/16" (678)[2]	
	25CDH3760-4

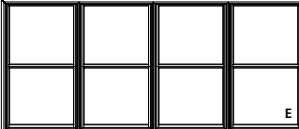
66 3/4" (1695)	
64 3/4" (1645)	
64" (1625)	
27 11/16" (703)[2]	
	25CDH3764-4

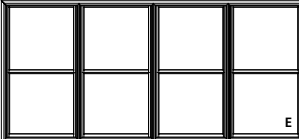
70 3/4" (1797)	
68 3/4" (1746)	
68" (1727)	
30 11/16" (779)[2]	
	25CDH3768-4

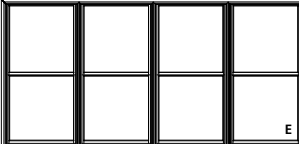
74 3/4" (1899)	
72 3/4" (1848)	
72" (1829)	
32 11/16" (830)[2]	
	25CDH3772-4

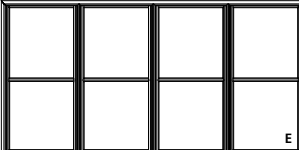
78 3/4" (2000)	
76 3/4" (1949)	
76" (1930)	
34 11/16" (881)[2]	
	25CDH3776-4

ELEVATION SYMBOL LEGEND:

VALUES IN () ARE IN MILLIMETER CONVERSIONS.

VALUES IN [] ARE NUMBER OF DAYLIGHT OPENINGS PER UNIT.

E UNIT MEETS EGRESS REQUIREMENTS FOR IRC CODE. STATE AND LOCAL EGRESS CODES MAY DIFFER. ALWAYS REFER TO LOCAL BUILDING CODES FOR COMPLETE REQUIREMENTS. CHECK WITH LOCAL OFFICIALS TO ENSURE COMPLIANCE BEFORE INSTALLING THE UNIT. SEE NOTES ON SINGLE UNIT ELEVATIONS FOR SPECIFIC EGRESS CAPABILITY.

SCALE: 1/8" = 1'

5 WIDE UNITS

UNIT SIZE
ROUGH OPENING
FRAME SIZE
DAYLIGHT OPENING

109 5/8" (2785)
107 5/8" (2734)
106 7/8" (2715)
16 1/16" (408)[5]

129 5/8" (3293)
127 5/8" (3242)
126 7/8" (3223)
20 1/16" (510)[5]

149 5/8" (3801)
147 5/8" (3750)
146 7/8" (3731)
24 1/16" (611)[5]

169 5/8" (4309)
167 5/8" (4258)
166 7/8" (4239)
28 1/16" (713)[5]

38 3/4" (984)
36 3/4" (933)
36" (914)
14 11/16" (373)[2]



25CDH2136-5

42 3/4" (1086)
40 3/4" (1035)
40" (1016)
16 11/16" (424)[2]



25CDH2140-5

50 3/4" (1289)
48 3/4" (1238)
48" (1219)
20 11/16" (525)[2]



25CDH2148-5

54 3/4" (1391)
52 3/4" (1340)
52" (1321)
22 11/16" (576)[2]



25CDH2152-5

58 3/4" (1492)
56 3/4" (1441)
56" (1441)
24 11/16" (627)[2]



25CDH2156-5

62 3/4" (1594)
60 3/4" (1543)
1543" (xxx)
26 11/16" (678)[2]



25CDH2160-5

66 3/4" (1695)
64 3/4" (1645)
64" (1626)
27 11/16" (709)[2]



25CDH2164-5

70 3/4" (1797)
68 3/4" (1746)
68" (1727)
30 11/16" (779)[2]



25CDH2168-5

74 3/4" (1899)
72 3/4" (1848)
72" (1829)
32 11/16" (830)[2]



25CDH2172-5

78 3/4" (2000)
76 3/4" (1949)
76" (1930)
34 11/16" (881)[2]



25CDH2176-5



25CDH2536-5



25CDH2540-5



25CDH2548-5



25CDH2552-5



25CDH2556-5



25CDH2560-5



25CDH2564-5



25CDH2568-5



25CDH2572-5



25CDH2576-5

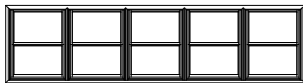

25CDH2936-5



25CDH2940-5



25CDH2948-5



25CDH2952-5



25CDH2956-5



25CDH2960-5



25CDH2964-5



25CDH2968-5



25CDH2972-5



25CDH2976-5



25CDH3336-5



25CDH3340-5



25CDH3348-5



25CDH3352-5



25CDH3356-5



25CDH3360-5



25CDH3364-5



25CDH3368-5



25CDH3372-5



25CDH3376-5

ELEVATION SYMBOL LEGEND:
VALUES IN () ARE IN MILLIMETER CONVERSIONS.
VALUES IN [] ARE NUMBER OF DAYLIGHT OPENINGS PER UNIT.

SCALE: 1/8" = 1'

5 WIDE UNITS

UNIT SIZE
ROUGH OPENING
FRAME SIZE
DAYLIGHT OPENING

189 5/8" (4817)
187 5/8" (4766)
186 7/8" (4747)
32 1/16" (814)[5]

189 5/8" (4817)
187 5/8" (4766)
186 7/8" (4747)
32 1/16" (814)[5]

38 3/4" (984)
36 3/4" (933)
35" (890)
35" (890)

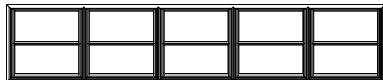

25CDH3736-5

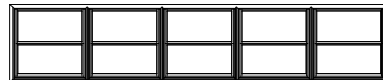

25CDH3736-5

42 3/4" (1086)
40 3/4" (1035)
40" (1016)
40" (1016)



25CDH3740-5



25CDH3740-5

50 3/4" (1289)
48 3/4" (1238)
48" (1219)
48" (1219)



25CDH3748-5



25CDH3748-5

54 3/4" (1391)
52 3/4" (1340)
52" (1321)
52" (1321)



25CDH3752-5



25CDH3752-5

58 3/4" (1492)
56 3/4" (1441)
56" (1422)
56" (1422)



25CDH3756-5



25CDH3756-5

62 3/4" (1594)
60 3/4" (1543)
60" (1524)
60" (1524)



25CDH3760-5



25CDH3760-5

66 3/4" (1695)
64 3/4" (1645)
64" (1626)
64" (1626)



25CDH3764-5



25CDH3764-5

70 3/4" (1797)
68 3/4" (1746)
68" (1727)
68" (1727)



25CDH3768-5



25CDH3768-5

74 3/4" (1899)
72 3/4" (1848)
72" (1829)
72" (1829)



25CDH3772-5



25CDH3772-5

78 3/4" (2000)
76 3/4" (1949)
76" (1930)
76" (1930)



25CDH3776-5



25CDH3776-5

ELEVATION SYMBOL LEGEND:
VALUES IN () ARE IN MILLIMETER CONVERSIONS.
VALUES IN [] ARE NUMBER OF DAYLIGHT OPENINGS PER UNIT.

SCALE: 1/8" = 1'

ELEVATION NOTES
PICTURE UNITS

ELEVATION DRAWINGS UTILIZE A LIMITED NUMBER OF PROJECTED LINES TO PRODUCE A RUDIMENTARY DRAWING INTENDED TO BE USED IN A SMALL GRAPHICAL SCALE. ELEVATIONS ARE VIEWED PERPENDICULAR FROM THE EXTERIOR OF THE STRUCTURE. IF MORE DIMENSIONS ARE NEEDED, USE THE SECTION DRAWINGS FOR MORE COMPLETE DEPICTIONS.

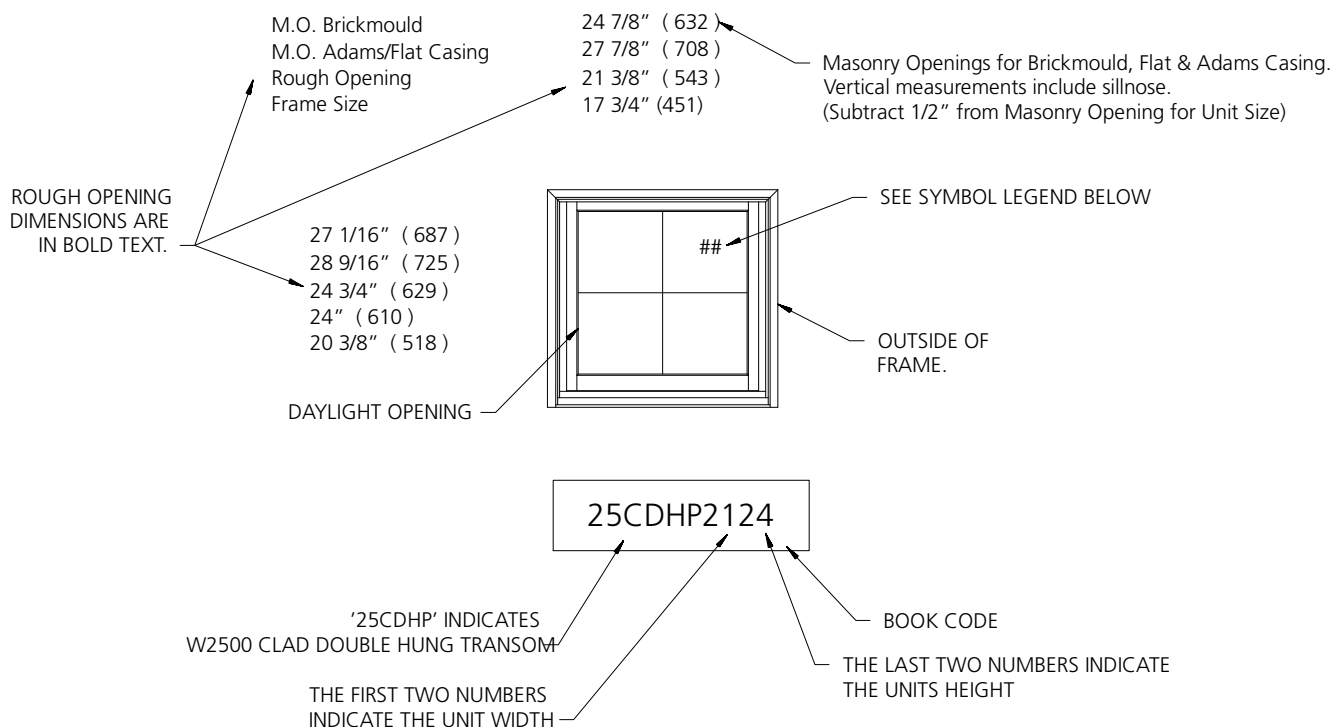

GENERAL DOUBLE HUNG TRANSOM NOTES

1. ALL UNITS SHOWN ARE AVAILABLE AS STATIONARY ONLY.
2. UNIT ELEVATIONS ARE SHOWN WITHOUT EXTERIOR TRIM.
3. DIMENSIONAL VALUES IN BRACKETS ARE MILLIMETER CONVERSIONS.

ELEVATION SYMBOL LEGEND:

NUMBER INDICATES DESIGN PRESSURE (DP) RATING WITH STANDARD GLAZING.

PICTURE UNITS

UNIT SIZE
ROUGH OPENING
FRAME SIZE
DAYLIGHT OPENING

14 3/4" (375) 12 3/4" (324) 12" (305) 7 1/4" (184)	20 3/4" (527) 18 3/4" (476) 18" (457) 12 3/4" (324)	26 3/4" (679) 24 3/4" (629) 24" (610) 18 3/4" (476)	32 3/4" (832) 30 3/4" (781) 30" (762) 24 3/4" (629)	38 3/4" (984) 36 3/4" (933) 36" (914) 30 3/4" (781)	42 3/4" (1086) 40 3/4" (1035) 40" (1016) 34 3/4" (883)	44 3/4" (1137) 42 3/4" (1086) 42" (1067) 36 3/4" (933)	
25CDHP1212	25CDHP1812	25CDHP2412	25CDHP3012	25CDHP3612	25CDHP4012	25CDHP4212	
20 3/4" (527) 18 3/4" (476) 18" (457) 13 1/4" (337)	25CDHP1218	25CDHP1818	25CDHP2418	25CDHP3018	25CDHP3618	25CDHP4018	25CDHP4218
26 3/4" (679) 24 3/4" (629) 24" (610) 19 1/4" (489)	25CDHP1224	25CDHP1824	25CDHP2424	25CDHP3024	25CDHP3624	25CDHP4024	25CDHP4224
32 3/4" (832) 30 3/4" (781) 30" (762) 25 1/4" (641)	25CDHP1230	25CDHP1830	25CDHP2430	25CDHP3030	25CDHP3630	25CDHP4030	25CDHP4230
38 3/4" (984) 36 3/4" (933) 36" (914) 31 1/4" (794)	25CDHP1236	25CDHP1836	25CDHP2436	25CDHP3036	25CDHP3636	25CDHP4036	25CDHP4236
42 3/4" (1086) 40 3/4" (1035) 40" (1016) 35 1/4" (895)	25CDHP1240	25CDHP1840	25CDHP2440	25CDHP3040	25CDHP3640	25CDHP4040	25CDHP4240
44 3/4" (1137) 42 3/4" (1086) 42" (1067) 37 1/4" (946)	25CDHP1242	25CDHP1842	25CDHP2442	25CDHP3042	25CDHP3642	25CDHP4042	25CDHP4242
50 3/4" (1289) 48 3/4" (1238) 48" (1219) 43 1/4" (1099)	25CDHP1248	25CDHP1848	25CDHP2448	25CDHP3048	25CDHP3648	25CDHP4048	25CDHP4248

ELEVATION SYMBOL LEGEND:

VALUES IN () ARE IN MILLIMETER CONVERSIONS.

NUMBER INDICATES DESIGN PRESSURE (DP) RATING WITH STANDARD GLAZING.

NUMBER INDICATES OPTIONAL DESIGN PRESSURE (DP) RATING.

Note: Elevations shown DO NOT have exterior trim. For other Trim Options refer to the Unit Sizing, Rough Opening and Masonry Opening page.

SCALE: 1/4" = 1'

PICTURE UNITS

UNIT SIZE	14 3/4" (375)	20 3/4" (527)	26 3/4" (679)	32 3/4" (832)	38 3/4" (984)	42 3/4" (1086)	44 3/4" (1137)
ROUGH OPENING	12 3/4" (324)	18 3/4" (476)	24 3/4" (629)	30 3/4" (781)	36 3/4" (933)	40 3/4" (1035)	42 3/4" (1086)
FRAME SIZE	12" (305)	18" (457)	24" (610)	30" (762)	36" (914)	40" (1016)	42" (1067)
DAYLIGHT OPENING	6 3/4" (171)	12 3/4" (324)	18 3/4" (476)	24 3/4" (629)	30 3/4" (781)	34 3/4" (883)	36 3/4" (933)
56 3/4" (1441) 56 3/4" (1391) 54" (1372) 49 1/4" (1251)							
58 3/4" (1492) 56 3/4" (1441) 56" (1422) 51 1/4" (1302)							
64 3/4" (1645) 62 3/4" (1594) 60" (1524) 55 1/4" (1403)							
66 3/4" (1695) 64 3/4" (1645) 64" (1626) 59 1/4" (1505)							
70 3/4" (1797) 68 3/4" (1746) 68" (1727) 63 1/4" (1607)							

ELEVATION SYMBOL LEGEND:
VALUES IN () ARE IN MILLIMETER CONVERSIONS.
NUMBER INDICATES DESIGN PRESSURE (DP) RATING WITH STANDARD GLAZING.
NUMBER INDICATES OPTIONAL DESIGN PRESSURE (DP) RATING.

SCALE: 1/4" = 1'

PICTURE UNITS



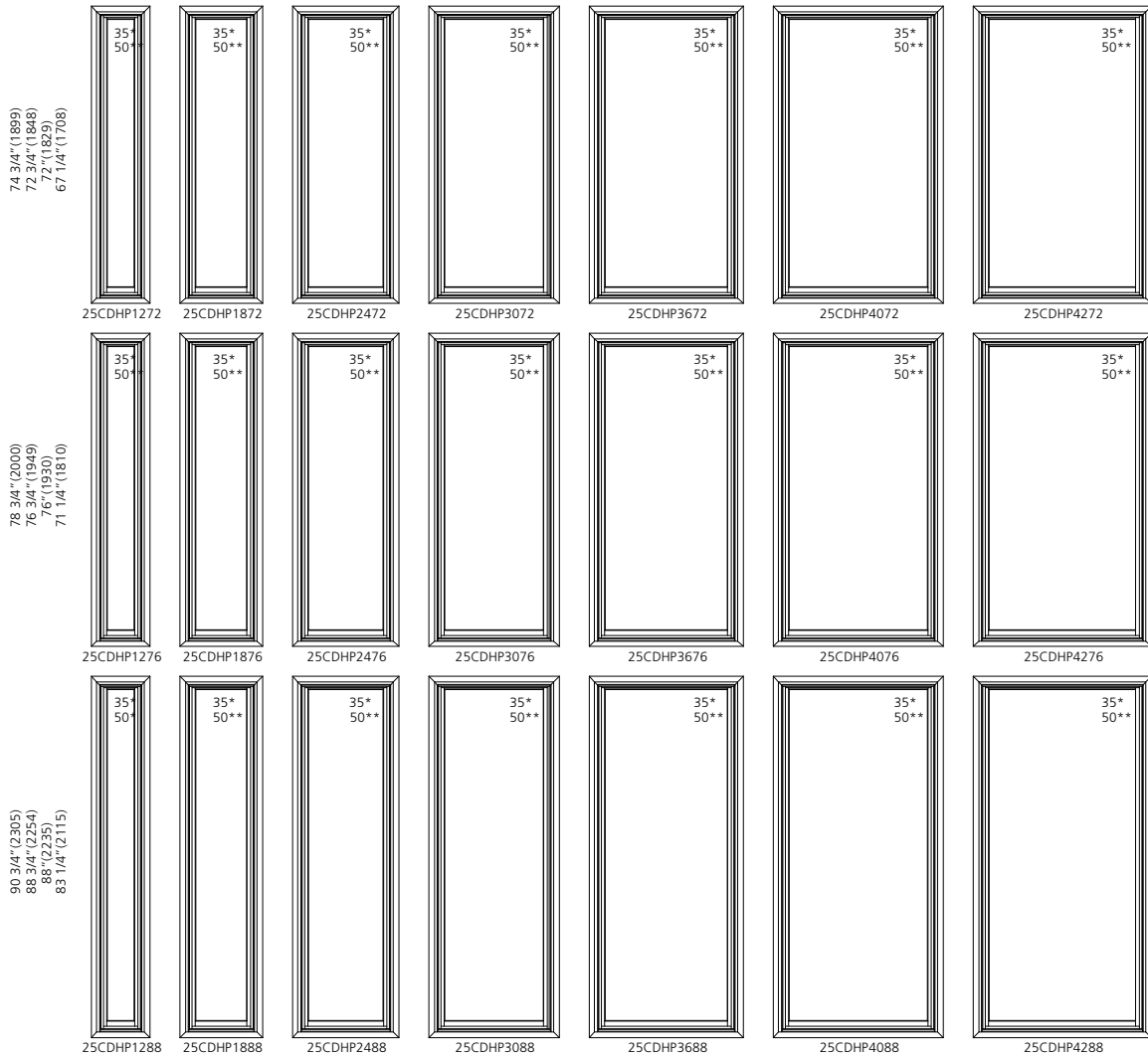











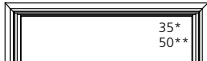
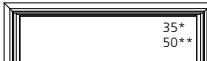
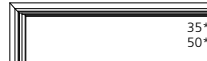
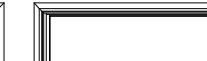







UNIT SIZE	14 3/4" (375)	20 3/4" (527)	26 3/4" (679)	32 3/4" (832)	38 3/4" (984)	42 3/4" (1086)	44 3/4" (1137)
ROUGH OPENING	12 3/4" (324)	18 3/4" (476)	24 3/4" (629)	30 3/4" (781)	36 3/4" (933)	40 3/4" (1035)	42 3/4" (1086)
FRAME SIZE	12" (305)	18" (457)	24" (610)	30" (762)	36" (914)	40" (1016)	42" (1067)
DAYLIGHT OPENING	6 3/4" (171)	12 3/4" (324)	18 3/4" (476)	24 3/4" (629)	30 3/4" (781)	34 3/4" (883)	36 3/4" (933)

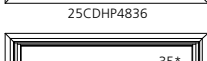
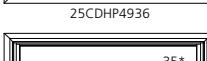

ELEVATION SYMBOL LEGEND:
 VALUES IN () ARE IN MILLIMETER CONVERSIONS.
 ### NUMBER INDICATES DESIGN PRESSURE (DP) RATING WITH STANDARD GLAZING.
 #### NUMBER INDICATES OPTIONAL DESIGN PRESSURE (DP) RATING.

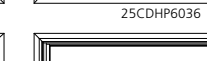
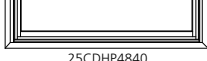
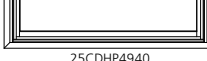
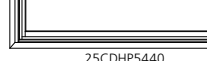
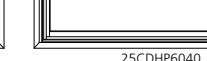
SCALE: 1/4" = 1'

PICTURE UNITS

UNIT SIZE ROUGH OPENING FRAME SIZE DAYLIGHT OPENING	50 3/4" (1289) 48 3/4" (1238) 48" (1219) 42 3/4" (1086)	52 1/8" (1324) 50 1/8" (1273) 49 3/8" (1254) 44" (1118)	56 3/4" (1441) 54 3/4" (1391) 54" (1372) 48 3/4" (1238)	62 3/4" (1594) 60 3/4" (1543) 60" (1524) 54 3/4" (1391)
14 3/4" (375) 12 3/4" (324) 12" (305) 7 1/4" (184)	 35* 50** 25CDHP4812	 35* 50** 25CDHP4912	 35* 50** 25CDHP5412	 35* 50** 25CDHP6012
20 3/4" (527) 18 3/4" (476) 18" (457) 13 1/4" (337)	 35* 50** 25CDHP4818	 35* 50** 25CDHP4918	 35* 50** 25CDHP5418	 35* 50** 25CDHP6018
26 3/4" (679) 24 3/4" (629) 24" (610) 19 1/4" (489)	 35* 50** 25CDHP4824	 35* 50** 25CDHP4924	 35* 50** 25CDHP5424	 35* 50** 25CDHP6024
32 3/4" (832) 30 3/4" (781) 30" (762) 25 1/4" (641)	 35* 50** 25CDHP4830	 35* 50** 25CDHP4930	 35** 50** 25CDHP5430	 35* 50** 25CDHP6030
38 3/4" (984) 36 3/4" (933) 36" (914) 31 1/4" (794)	 35* 50** 25CDHP4836	 35* 50** 25CDHP4936	 35* 50** 25CDHP5436	 35* 50** 25CDHP6036
42 3/4" (1086) 40 3/4" (1035) 40" (1016) 35 1/4" (895)	 35* 50** 25CDHP4840	 35* 50** 25CDHP4940	 35* 50** 25CDHP5440	 35* 50** 25CDHP6040
44 3/4" (1137) 42 3/4" (1086) 42" (1067) 37 1/4" (946)	 35* 50** 25CDHP4842	 35* 50** 25CDHP4942	 35* 50** 25CDHP5442	 35* 50** 25CDHP6042
50 3/4" (1289) 48 3/4" (1238) 48" (1219) 43 1/4" (1099)	 35* 50* 25CDHP4848	 35* 50* 25CDHP4948	 35* 50* 25CDHP5448	 35* 50* 25CDHP6048

ELEVATION SYMBOL LEGEND:
 VALUES IN () ARE IN MILLIMETER CONVERSIONS.
 *** NUMBER INDICATES DESIGN PRESSURE (DP) RATING WITH STANDARD GLAZING.
 **** NUMBER INDICATES OPTIONAL DESIGN PRESSURE (DP) RATING.

SCALE: 1/4" = 1'

PICTURE UNITS

UNIT SIZE
ROUGH OPENING
FRAME SIZE
DAYLIGHT OPENING

50 3/4"(1289)
48 3/4"(1238)
48"(1219)
42 3/4"(1086)

52 1/8"(1324)
50 1/8"(1273)
49 3/8"(1254)
44"(1118)

56 3/4"(1441)
54 3/4"(1391)
54"(1372)
48 3/4"(1238)

62 3/4"(1594)
60 3/4"(1543)
60"(1524)
54 3/4"(1391)

56 3/4"(1441)
54 3/4"(1391)
54"(1372)
49 1/4"(1251)

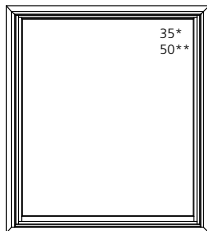

25CDHP4854

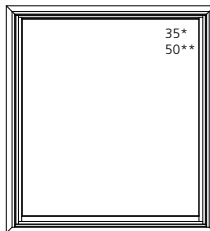

25CDHP4954

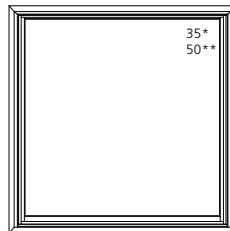

25CDHP5454

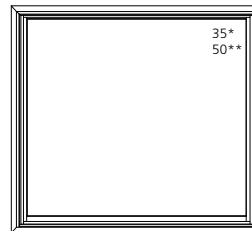

25CDHP6054

58 3/4"(1492)
56 3/4"(1441)
56"(1422)
51 1/4"(1302)

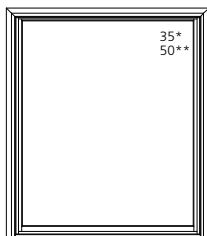

25CDHP4856

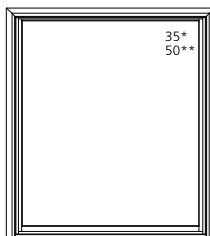

25CDHP4956

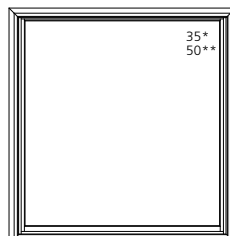

25CDHP5456

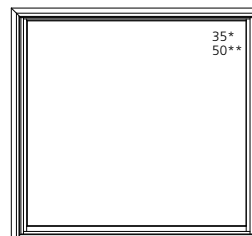

25CDHP6056

64 3/4"(1645)
62 3/4"(1594)
60"(1524)
55 1/4"(1403)

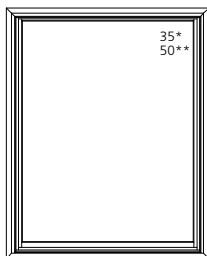

25CDHP4860

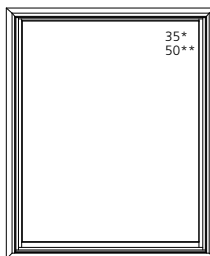

25CDHP4960

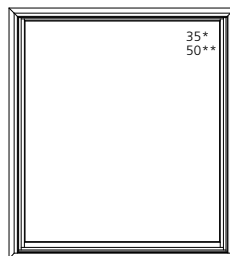

25CDHP5460

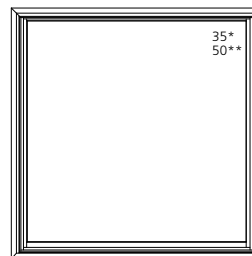

25CDHP6060

66 3/4"(1695)
64 3/4"(1645)
64"(1626)
59 1/4"(1505)

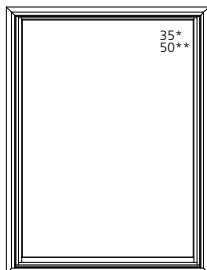

25CDHP4864

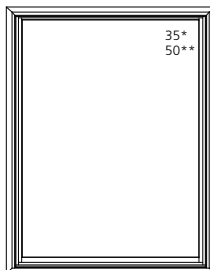

25CDHP4964

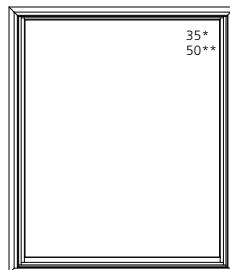

25CDHP5464

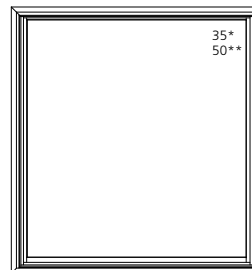

25CDHP6064

70 3/4"(1797)
68 3/4"(1746)
68"(1727)
63 1/4"(1607)

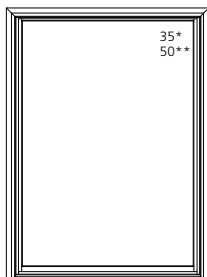

25CDHP4868

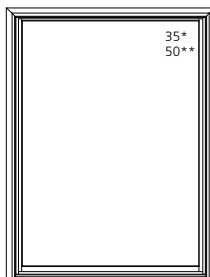

25CDHP4968

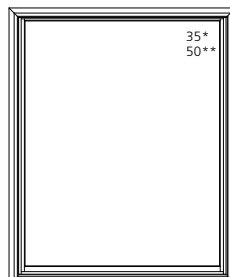

25CDHP5468

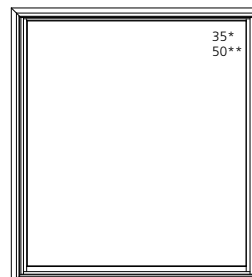

25CDHP6068

ELEVATION SYMBOL LEGEND:

VALUES IN () ARE IN MILLIMETER CONVERSIONS.

NUMBER INDICATES DESIGN PRESSURE (DP) RATING WITH STANDARD GLAZING.

NUMBER INDICATES OPTIONAL DESIGN PRESSURE (DP) RATING.

SCALE: 1/4" = 1'

PICTURE UNITS

UNIT SIZE
ROUGH OPENING
FRAME SIZE
DAYLIGHT OPENING

50 3/4" (1289)
48 3/4" (1238)
48" (1219)
42 3/4" (1086)

52 1/8" (1324)
50 1/8" (1273)
49 3/8" (1254)
44" (1118)

56 3/4" (1441)
54 3/4" (1391)
54" (1372)
48 3/4" (1238)

62 3/4" (1594)
60 3/4" (1543)
60" (1524)
54 3/4" (1391)

74 3/4" (1899)
72 3/4" (1848)
72" (1829)
67 1/4" (1708)

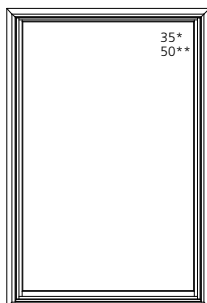

25CDHP4872

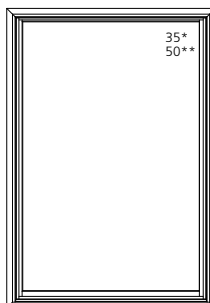

25CDHP4972

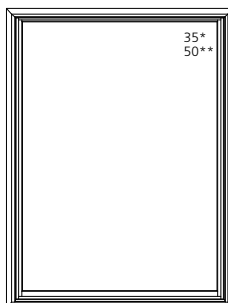

25CDHP5472

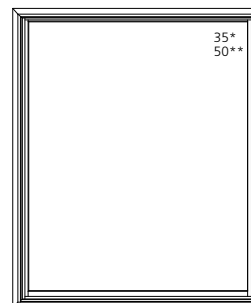

25CDHP6072

78 3/4" (2000)
76 3/4" (1949)
76" (1930)
71 1/4" (1810)

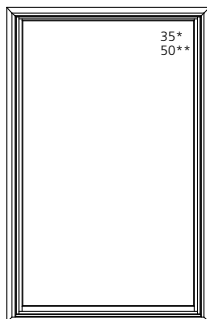

25CDHP4876

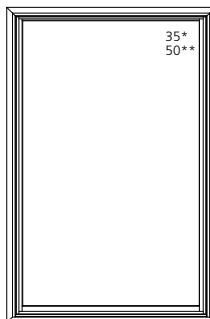

25CDHP4976

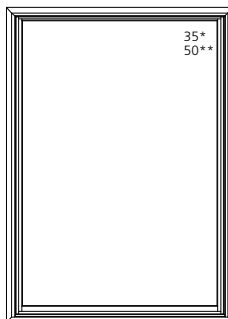

25CDHP5476

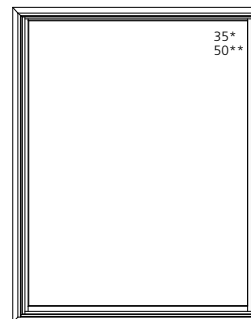

25CDHP6076

90 3/4" (2305)
88 3/4" (2254)
88" (2235)
83 1/4" (2115)

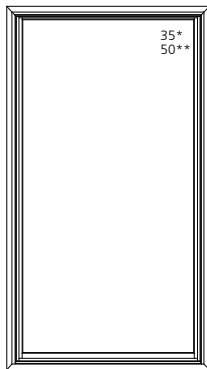

25CDHP4888

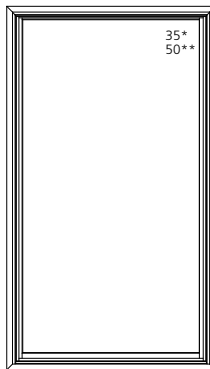

25CDHP4988

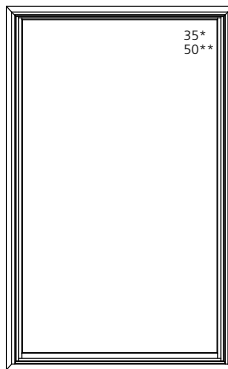

25CDHP5488

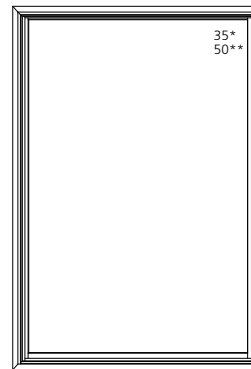

25CDHP6088

ELEVATION SYMBOL LEGEND:

VALUES IN () ARE IN MILLIMETER CONVERSIONS.

















NUMBER INDICATES DESIGN PRESSURE (DP) RATING WITH STANDARD GLAZING.

###* NUMBER INDICATES OPTIONAL DESIGN PRESSURE (DP) RATING.

SCALE: 1/4" = 1'

PICTURE UNITS

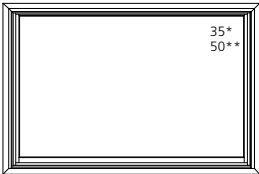
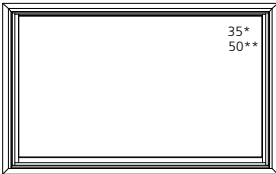
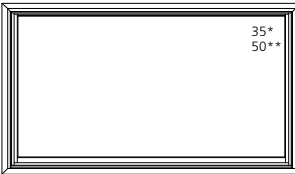
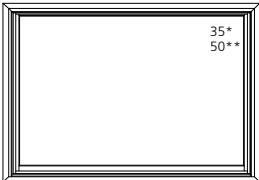
UNIT SIZE
ROUGH OPENING
FRAME SIZE
DAYLIGHT OPENING

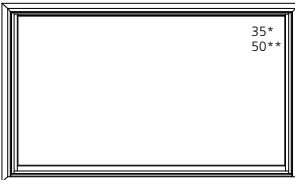
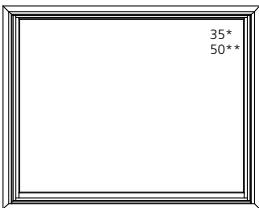
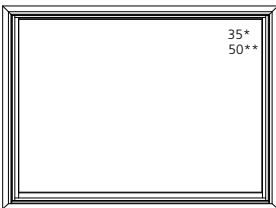
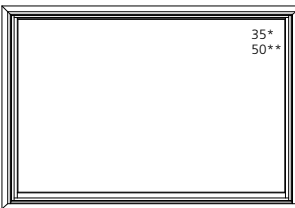
UNIT SIZE ROUGH OPENING FRAME SIZE DAYLIGHT OPENING	64 1/8" (1629) 62 1/8" (1578) 61 3/8" (1559) 56" (1422)	68 3/4" (1746) 66 3/4" (1695) 66" (1676) 60 3/4" (1543)	74 3/4" (1899) 72 3/4" (1848) 72" (1829) 66 3/4" (1695)
14 3/4" (375) 12 3/4" (324) 12" (305) 7 1/4" (184)	 25CDHP6112	 25CDHP6612	 25CDHP7212
20 3/4" (527) 18 3/4" (476) 18" (457) 13 1/4" (337)	 25CDHP6118	 25CDHP6618	 25CDHP7218
26 3/4" (679) 24 3/4" (629) 24" (610) 19 1/4" (489)	 25CDHP6124	 25CDHP6624	 25CDHP7224
32 3/4" (832) 30 3/4" (781) 30" (762) 25 1/4" (641)	 25CDHP6130	 25CDHP6630	 25CDHP7230
38 3/4" (984) 36 3/4" (933) 36" (914) 31 1/4" (794)	 25CDHP6136	 25CDHP6636	 25CDHP7236
42 3/4" (1086) 40 3/4" (1035) 40" (1016) 35 1/4" (895)	 25CDHP6140	 25CDHP6640	 25CDHP7240
44 3/4" (1137) 42 3/4" (1086) 42" (1067) 37 1/4" (946)	 25CDHP6142	 25CDHP6642	 25CDHP7242
50 3/4" (1289) 48 3/4" (1238) 48" (1219) 43 1/4" (1099)	 25CDHP6148	 25CDHP6648	 25CDHP7248

ELEVATION SYMBOL LEGEND:

VALUES IN () ARE IN MILLIMETER CONVERSIONS.

*** NUMBER INDICATES DESIGN PRESSURE (DP) RATING WITH STANDARD GLAZING.

**** NUMBER INDICATES OPTIONAL DESIGN PRESSURE (DP) RATING.

SCALE: 1/4" = 1'

PICTURE UNITS

UNIT SIZE
ROUGH OPENING
FRAME SIZE
DAYLIGHT OPENING

64 1/8" (1629)
62 1/8" (1578)
61 3/8" (1559)
56" (1422)

68 3/4" (1746)
66 3/4" (1695)
66" (1676)
60 3/4" (1543)

74 3/4" (1899)
72 3/4" (1848)
72" (1829)
66 3/4" (1695)

56 3/4" (1441)
54 3/4" (1391)
54" (1372)
49 1/4" (1251)

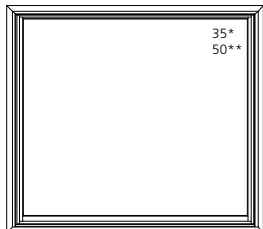

25CDHP6154

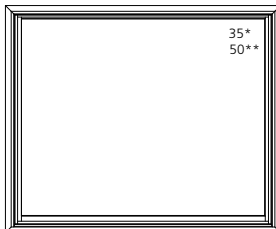

25CDHP6654

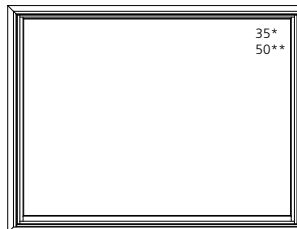

25CDHP7254

58 3/4" (1492)
56 3/4" (1441)
56" (1422)
51 1/4" (1302)

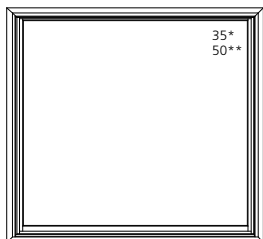

25CDHP6156

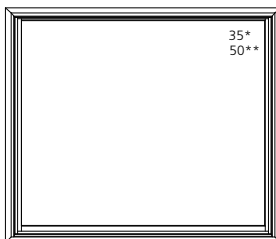

25CDHP6656



25CDHP7256

64 3/4" (1645)
62 3/4" (1594)
60" (1524)
55 1/4" (1403)

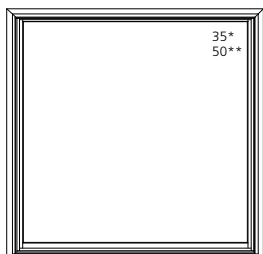

25CDHP6160

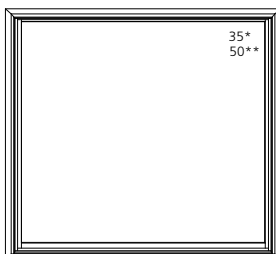

25CDHP6660

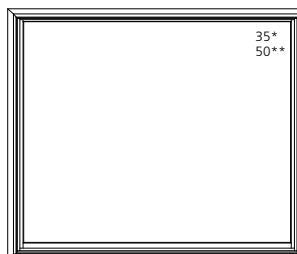

25CDHP7260

66 3/4" (1695)
64 3/4" (1645)
64" (1626)
59 1/4" (1505)

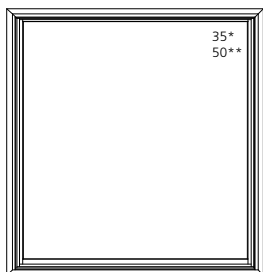

25CDHP6164

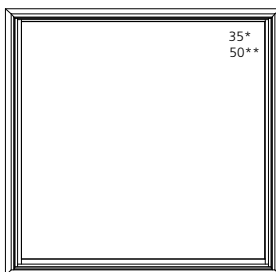

25CDHP6664

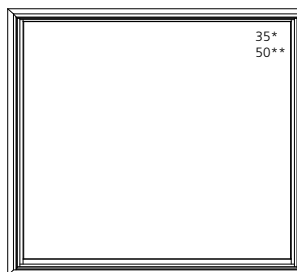

25CDHP7264

70 3/4" (1797)
68 3/4" (1746)
68" (1727)
63 1/4" (1607)

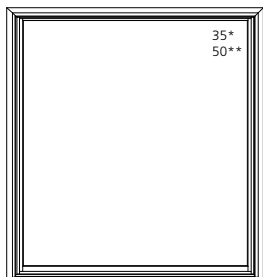

25CDHP6168

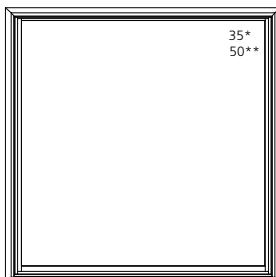

25CDHP6668

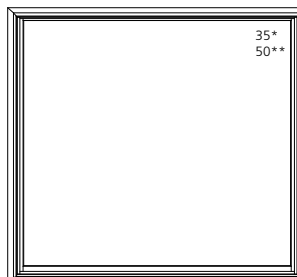

25CDHP7268

ELEVATION SYMBOL LEGEND:

VALUES IN () ARE IN MILLIMETER CONVERSIONS.

NUMBER INDICATES DESIGN PRESSURE (DP) RATING WITH STANDARD GLAZING.

NUMBER INDICATES OPTIONAL DESIGN PRESSURE (DP) RATING.

SCALE: 1/4" = 1'

PICTURE UNITS

UNIT SIZE
 ROUGH OPENING
 FRAME SIZE
 DAYLIGHT OPENING

64 1/8" (1629)
 62 1/8" (1578)
 61 3/8" (1559)
 56" (1422)

68 3/4" (1746)
 66 3/4" (1695)
 66" (1676)
 60 3/4" (1543)

74 3/4" (1899)
 72 3/4" (1848)
 72" (1829)
 66 3/4" (1695)

74 3/4" (1899)
 72 3/4" (1848)
 72" (1829)
 67 1/4" (1708)

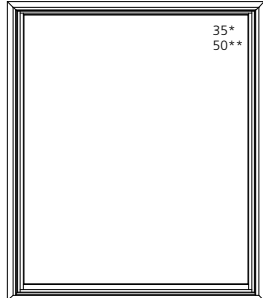

25CDHP6172

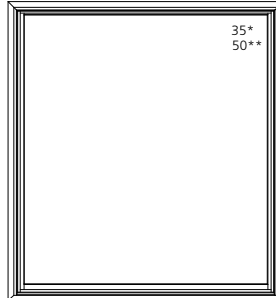

25CDHP6672

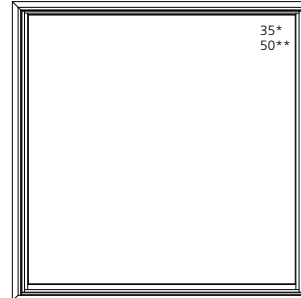

25CDHP7272

78 3/4" (2000)
 76 3/4" (1949)
 76" (1930)
 71 1/4" (1810)

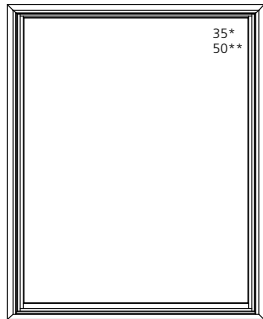

25CDHP6176

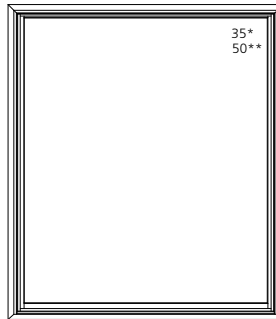

25CDHP6676

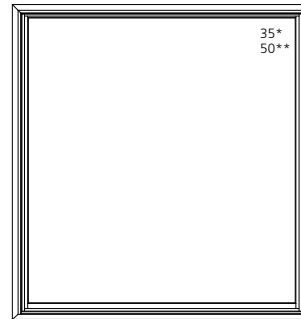

25CDHP7276

90 3/4" (2305)
 88 3/4" (2254)
 88" (2235)
 83 1/4" (2115)

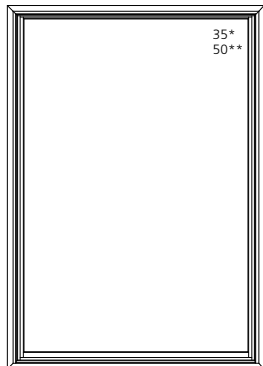

25CDHP6188

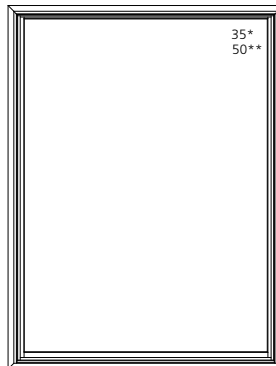

25CDHP6688

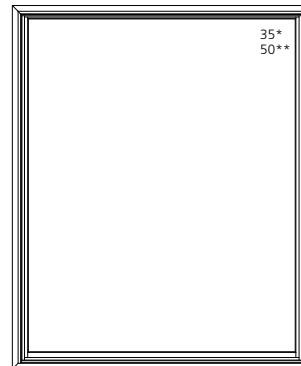

25CDHP7288

ELEVATION SYMBOL LEGEND:
 VALUES IN () ARE IN MILLIMETER CONVERSIONS.
 ### NUMBER INDICATES DESIGN PRESSURE (DP) RATING WITH STANDARD GLAZING.
 ###* NUMBER INDICATES OPTIONAL DESIGN PRESSURE (DP) RATING.

SCALE: 1/4" = 1'

ELEVATION NOTES
TRANSOM UNITS

ELEVATION DRAWINGS UTILIZE A LIMITED NUMBER OF PROJECTED LINES TO PRODUCE A RUDIMENTARY DRAWING INTENDED TO BE USED IN A SMALL GRAPHICAL SCALE. ELEVATIONS ARE VIEWED PERPENDICULAR FROM THE EXTERIOR OF THE STRUCTURE. IF MORE DIMENSIONS ARE NEEDED, USE THE SECTION DRAWINGS FOR MORE COMPLETE DEPICTIONS.

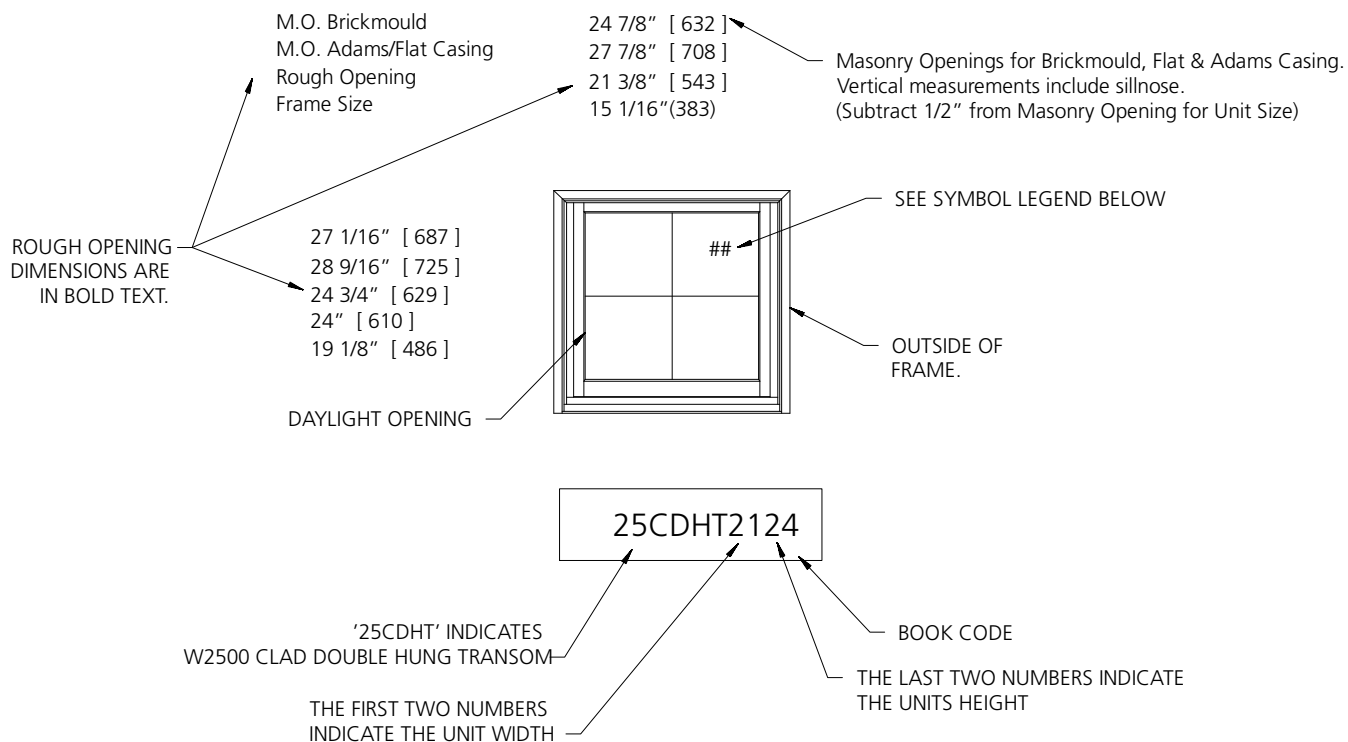



GENERAL DOUBLE HUNG TRANSOM NOTES

1. ALL UNITS SHOWN ARE AVAILABLE AS STATIONARY ONLY.
2. UNIT ELEVATIONS ARE SHOWN WITHOUT EXTERIOR TRIM.
3. DIMENSIONAL VALUES IN BRACKETS ARE MILLIMETER CONVERSIONS.
4. UNIT SHOWN IS FOR A W-2500 DH TRANSOM WITH STANDARD SASH, THE TRADITION SASH OPTION WILL HAVE A DIFFERENT DAYLIGHT OPENING VALUE.

ELEVATION SYMBOL LEGEND:

NUMBER INDICATES DESIGN PRESSURE (DP) RATING WITH STANDARD GLAZING.

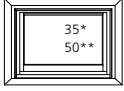
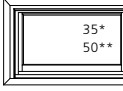
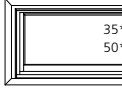
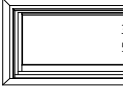
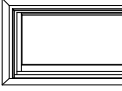
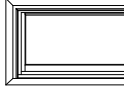
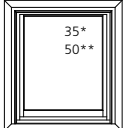
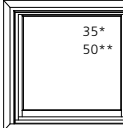
TRANSOM UNITS - 1 WIDE

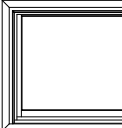
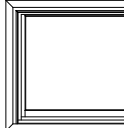
UNIT SIZE	24 1/8"(613)	28 1/8"(714)	32 1/8"(816)	36 1/8"(918)	40 1/8"(1019)	44 1/8"(1121)
ROUGH OPENING	22 1/8"(562)	26 1/8"(664)	30 1/8"(765)	34 1/8"(867)	38 1/8"(968)	42 1/8"(1070)
FRAME SIZE	21 3/8"(543)	25 3/8"(645)	29 3/8"(746)	33 3/8"(848)	37 3/8"(949)	41 3/8"(1051)
DAYLIGHT OPENING	16"(406)	20"(508)	24"(610)	28"(711)	32"(813)	36"(914)
17 3/4"(451) 15 3/4"(400) 15"(381) 10 3/16"(259)						
	25CDHT2115	25CDHT2515	25CDHT2915	25CDHT3315	25CDHT3715	25CDHT4115
26 3/4"(680) 24 3/4"(629) 24"(610) 19 3/16"(487)						
	25CDHT2124	25CDHT2524	25CDHT2924	25CDHT3324	25CDHT3724	25CDHT4124

ELEVATION SYMBOL LEGEND:
 VALUES IN () ARE IN MILLIMETER CONVERSIONS.
 ##* NUMBER INDICATES DESIGN PRESSURE (DP) RATING WITH STANDARD GLAZING.
 ##** NUMBER INDICATES OPTIONAL DESIGN PRESSURE (DP) RATING.

SCALE: 1/4" = 1'

TRANSOM UNITS - 1 WIDE - NOMINAL

UNIT SIZE
ROUGH OPENING
FRAME SIZE
DAYLIGHT OPENING

22" (559)
20" (508)
19 1/4" (489)
13 15/16" (354)

26" (660)
24" (610)
23 1/4" (591)
17 15/16" (456)

30" (762)
28" (711)
27 1/4" (692)
21 15/16" (557)

34" (864)
32" (813)
31 1/4" (794)
25 15/16" (659)

38" (965)
36" (914)
35 1/4" (895)
29 15/16" (760)

20" (508)
18" (457)
17 1/4" (438)
12 7/16" (259)

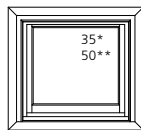

25CDHT2018N

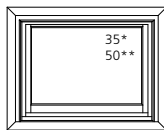

25CDHT2418N

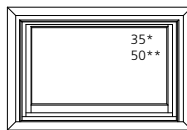

25CDHT2818N

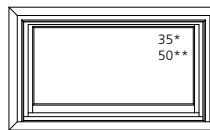

25CDHT3218N



25CDHT3618N

ELEVATION SYMBOL LEGEND:
VALUES IN () ARE IN MILLIMETER CONVERSIONS.
##* NUMBER INDICATES DESIGN PRESSURE (DP) RATING WITH STANDARD GLAZING.
##** NUMBER INDICATES OPTIONAL DESIGN PRESSURE (DP) RATING.
N INDICATES NOMINAL SIZING.

SCALE: 1/4" = 1'

TRANSOM UNITS - 2 WIDE

UNIT SIZE
ROUGH OPENING
FRAME SIZE
DAYLIGHT OPENING

53 1/2" (1359)
51 1/2" (1308)
50 3/4" (1365)
20 1/16" (510)[2]

61 1/2" (1562)
59 1/2" (1511)
58 3/4" (1492)
24 1/16" (611)[2]

69 1/2" (1765)
67 1/2" (1715)
66 3/4" (1696)
28 1/16" (713)[2]

17 3/4" (451)
15 3/4" (400)
15" (381)
10 3/16" (259)

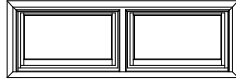

25CDHT2515-2

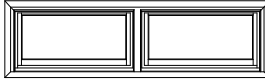

25CDHT2915-2

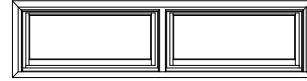

25CDHT3315-2

26 3/4" (680)
24 3/4" (629)
24" (610)
19 3/16" (487)

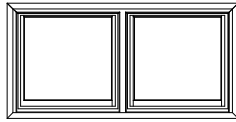

25CDHT2524-2

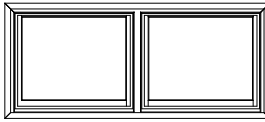

25CDHT2924-2

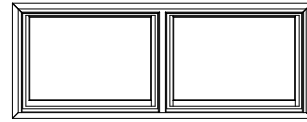

25CDHT3324-2

UNIT SIZE
ROUGH OPENING
FRAME SIZE
DAYLIGHT OPENING

77 1/2" (1969)
75 1/2" (1918)
74 3/4" (1899)
32 1/16" (814)[2]

17 3/4" (451)
15 3/4" (400)
15" (381)
10 3/16" (259)



25CDHT3715-2

26 3/4" (680)
24 3/4" (629)
24" (610)
19 3/16" (487)

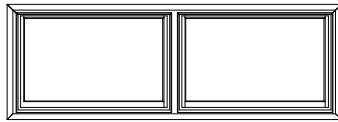

25CDHT3724-2

ELEVATION SYMBOL LEGEND:
VALUES IN () ARE IN MILLIMETER CONVERSIONS.
VALUES IN [] ARE NUMBER OF DAYLIGHT OPENINGS PER UNIT.

TRANSOM UNITS - 3 WIDE

UNIT SIZE
ROUGH OPENING
FRAME SIZE
DAYLIGHT OPENING

78 7/8" (2003)
76 7/8" (1953)
76 1/8" (1934)
20 1/16" (510)[3]

90 7/8" (2308)
88 7/8" (2257)
88 1/8" (2238)
24 1/16" (611)[3]

102 7/8" (2613)
100 7/8" (2562)
100 1/8" (2543)
28 1/16" (713)[3]

17 3/4" (451)
15 3/4" (400)
15" (381)
10 3/16" (259)



25CDHT2515-3



25CDHT2915-3

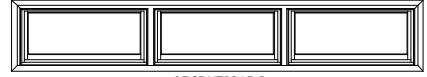

25CDHT3315-3

26 3/4" (680)
24 3/4" (629)
24" (610)
19 3/16" (487)

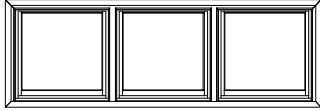

25CDHT2524-3

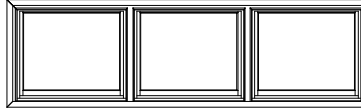

25CDHT2924-3

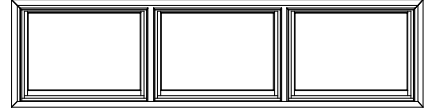

25CDHT3324-3

UNIT SIZE
ROUGH OPENING
FRAME SIZE
DAYLIGHT OPENING

114 7/8" (2918)
112 7/8" (2867)
112 1/8" (2848)
32 1/16" (814)[3]

17 3/4" (451)
15 3/4" (400)
15" (381)
10 3/16" (259)



25CDHT3715-3

26 3/4" (680)
24 3/4" (629)
24" (610)
19 3/16" (487)



25CDHT3724-3

ELEVATION SYMBOL LEGEND:
VALUES IN () ARE IN MILLIMETER CONVERSIONS.
VALUES IN [] ARE NUMBER OF DAYLIGHT OPENINGS PER UNIT.

SCALE: 1/4" = 1'

TRANSOM UNITS - 4 WIDE

UNIT SIZE
ROUGH OPENING
FRAME SIZE
DAYLIGHT OPENING

104 1/4" (2648)
102 1/4" (2597)
101 1/2" (2578)
20 1/16" (510)[4]

120 1/4" (3054)
118 1/4" (3004)
117 1/2" (2985)
24 1/16" (611)[4]

17 3/4" (451)
15 3/4" (400)
15" (381)
10 3/16" (259)

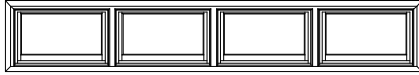

25CDHT2515-4

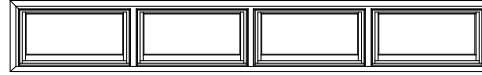

25CDHT2915-4

26 3/4" (680)
24 3/4" (629)
24" (610)
19 3/16" (487)

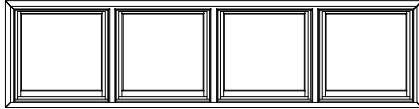

25CDHT2524-4

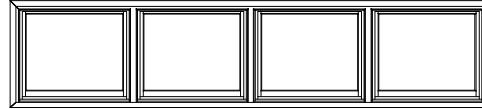

25CDHT2924-4

UNIT SIZE
ROUGH OPENING
FRAME SIZE
DAYLIGHT OPENING

136 1/4" (3461)
134 1/4" (3410)
133 1/2" (3391)
28 1/16" (713)[4]

152 1/4" (3867)
150 1/4" (3816)
149 1/2" (3797)
32 1/16" (814)[4]

17 3/4" (451)
15 3/4" (400)
15" (381)
10 3/16" (259)

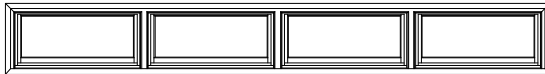

25CDHT3315-4

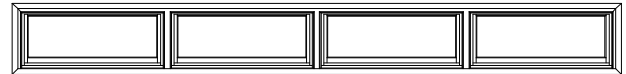

25CDHT3715-4

26 3/4" (680)
24 3/4" (629)
24" (610)
19 3/16" (487)

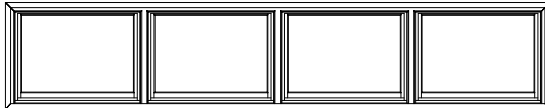

25CDHT3324-4

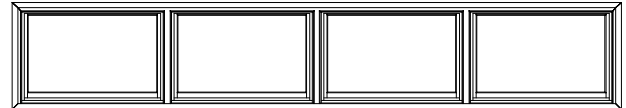

25CDHT3724-4

ELEVATION SYMBOL LEGEND:
VALUES IN () ARE IN MILLIMETER CONVERSIONS.
VALUES IN [] ARE NUMBER OF DAYLIGHT OPENINGS PER UNIT.

SCALE: 1/4" = 1'

TRANSOM UNITS - 5 WIDE

UNIT SIZE
ROUGH OPENING
FRAME SIZE
DAYLIGHT OPENING

129 3/8" (3286)
127 3/8" (3235)
126 7/8" (3223)
20 1/16" (510)[5]

149 3/8" (3794)
147 3/8" (3743)
146 7/8" (3731)
24 1/16" (611)[5]

17 3/4" (451)
15 3/4" (400)
15" (381)
10 3/16" (259)

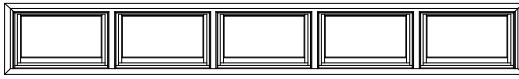

25CDHT2515-5

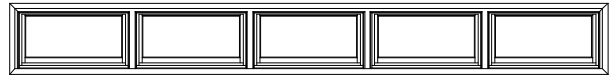

25CDHT2915-5

26 3/4" (680)
24 3/4" (629)
24" (610)
19 3/16" (487)

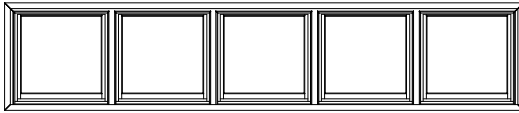

25CDHT2524-5

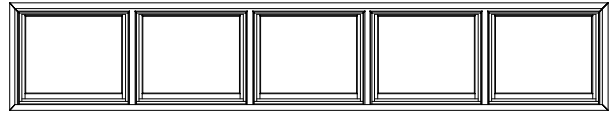

25CDHT2924-5

UNIT SIZE
ROUGH OPENING
FRAME SIZE
DAYLIGHT OPENING

169 3/8" (4302)
167 3/8" (4251)
166 7/8" (4239)
28 1/16" (713)[5]

17 3/4" (451)
15 3/4" (400)
15" (381)
10 3/16" (259)



25CDHT3315-5

26 3/4" (680)
24 3/4" (629)
24" (610)
19 3/16" (487)

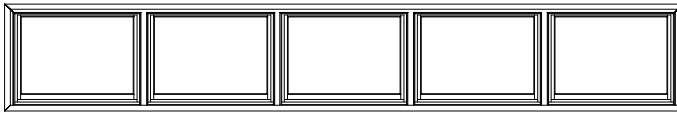

25CDHT3324-5

UNIT SIZE
ROUGH OPENING
FRAME SIZE
DAYLIGHT OPENING

189 3/8" (4810)
187 3/8" (4759)
186 7/8" (4747)
32 1/16" (814)[5]

17 3/4" (451)
15 3/4" (400)
15" (381)
10 3/16" (259)



25CDHT3715-5

26 3/4" (680)
24 3/4" (629)
24" (610)
19 3/16" (487)



25CDHT3724-5

ELEVATION SYMBOL LEGEND:
VALUES IN () ARE IN MILLIMETER CONVERSIONS.
VALUES IN [] ARE NUMBER OF DAYLIGHT OPENINGS PER UNIT.

SCALE: 1/4" = 1'

GLAZING OPTIONS

INTERIOR GLAZING OPTIONS

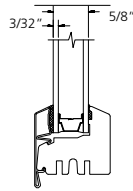

**DOUBLE
HUNG
SS//SS**

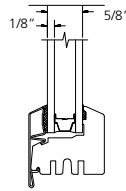

**DOUBLE
HUNG
DS//DS**

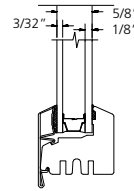

**DOUBLE
HUNG
CA URBAN FIRE CODE**

JAMB EXTENDER OPTIONS

JAMB EXTENDER OPTIONS

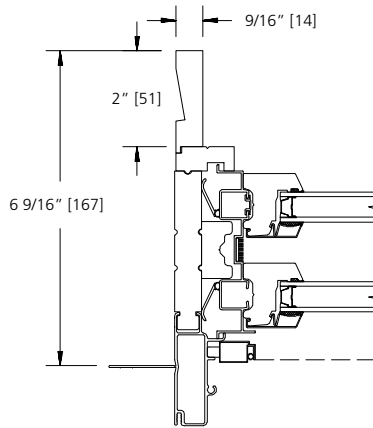

**6 9/16" WALL
 9/16" JAMB THICKNESS
 (OPTION)**

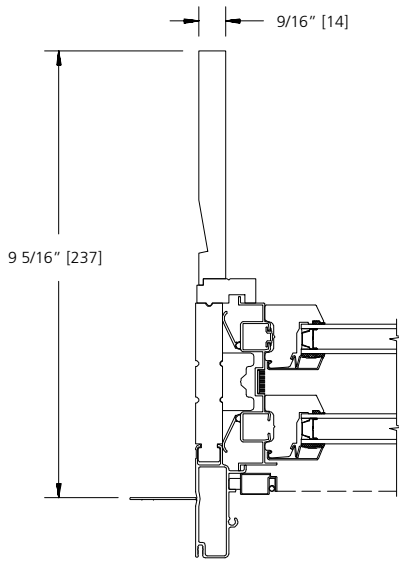

**9 5/16" WALL
 MAX 1-PC
 JAMB EXTENDER**

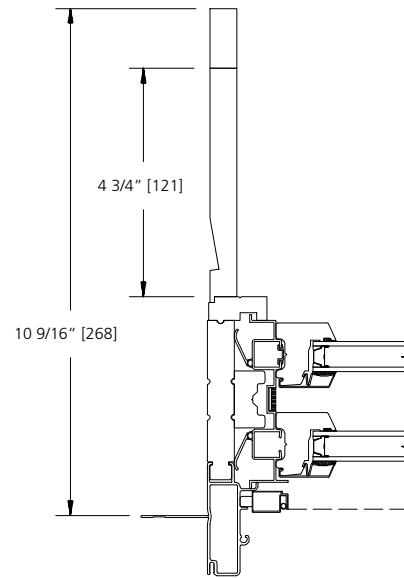

**10 9/16" WALL
 MAX WALL DEPTH**

STANDARD MULLION OPTIONS

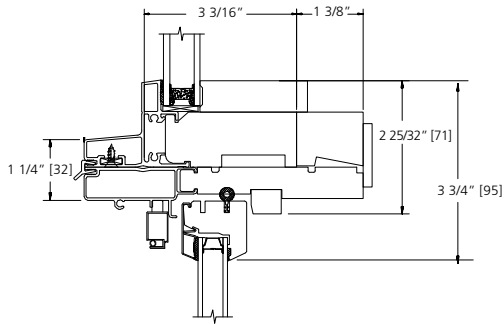

**OPERATING DOUBLE HUNG
 WITH DIRECT SET GEO**

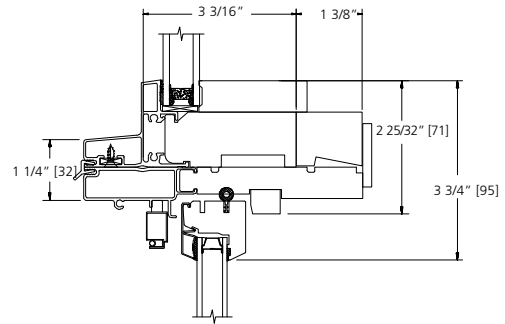

**OPERATING DOUBLE HUNG
 WITH DIRECT SET RADIUS**

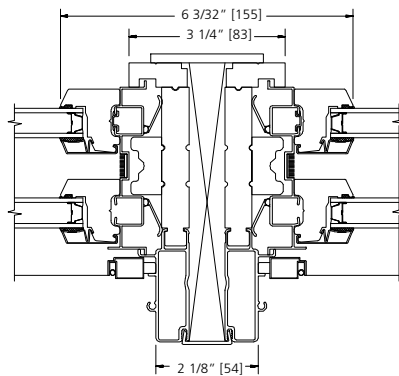

**TWIN OPERATING DOUBLE HUNG
 WITH 3/4" SOLID SPREAD MULL**

STANDARD MULLION OPTIONS

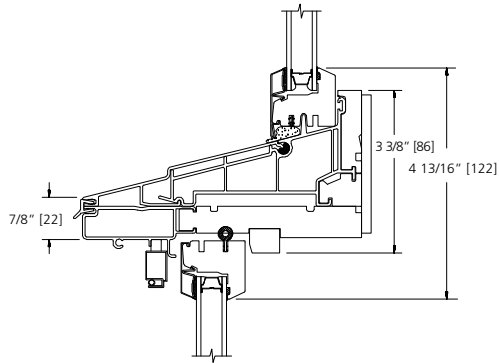

**OPERATING DOUBLE HUNG
 WITH IN-SASH PICTURE/TRANSOM**

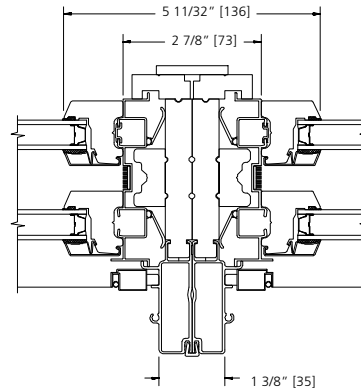

TWIN OPERATING DOUBLE HUNG

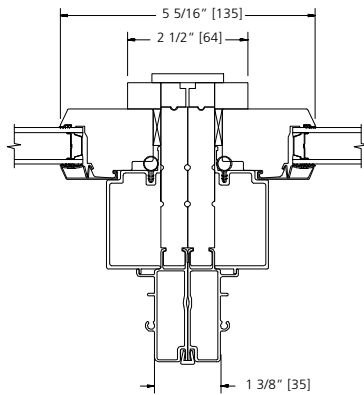

**IN-SASH PICTURE/TRANSOM BESIDE
 IN-SASH PICTURE/TRANSOM**

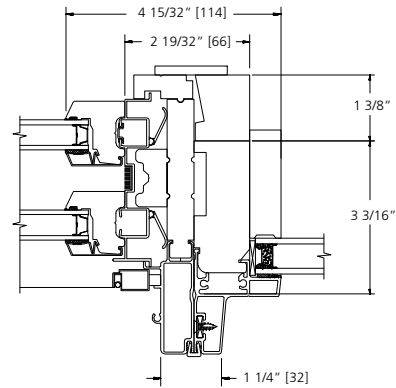

**OPERATING DOUBLE-HUNG BESIDE
 IN-SASH PICTURE/TRANSOM**

LITE CUT INFORMATION

Clad double hung windows are available with removable grilles in 7/8" Full surround or beaded SDL only, 5/8" flat or 23/32" contour grilles between the glass (GBG) and Simulated Divided Lites. Standard lite cuts are rectangular,

LITE CUT OPTIONS

Special lite cut patterns can include a wide variety of straight line and radius patterns. The illustrations shown here represent just a few of the possibilities. Rectangular, horizontal, vertical and Prairie lite patterns are available in all standard size clad double hung windows. Uneven, diamond, radius and Gothic lite cuts are available, subject to approval. Approvals are based on the ability to fulfill the design requirement while maintaining the construction integrity of the finished product.

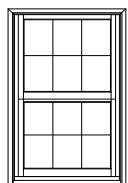

RECTANGULAR

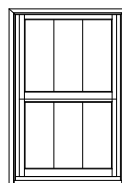

VERTICAL

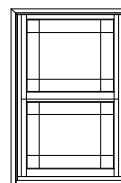

PRAIRIE

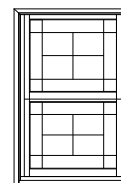

UNEVEN

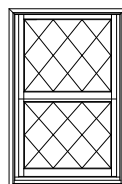

DIAMOND

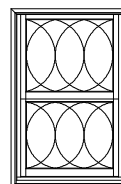

RADIUS

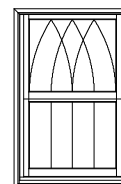

GOTHIC

BAR ALIGNMENT

Alignment of divided lite muntin bars from one window to the next is often required by fine architectural design. Wood grilles, GBG's, and Simulated Divided Lites may be specified with muntin bars aligned.

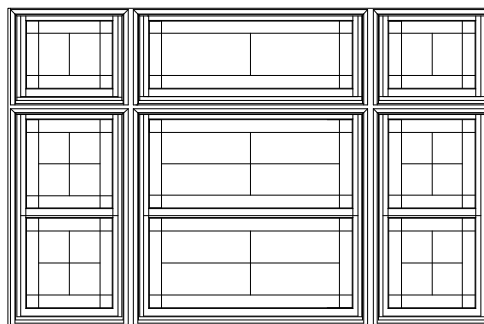

DIVIDED LITE OPTIONS

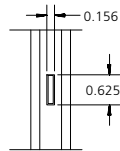

5/8" GRILLE

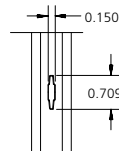

23/32" GRILLE

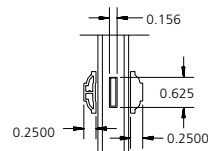

7/8" SDL

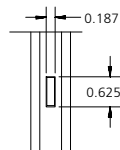

5/8" GRILLE

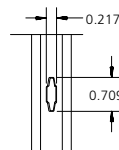

23/32" GRILLE

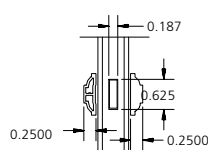

7/8" SDL

NOTES:

ALL GLASS AND AIRSPACE DIMENSIONS PER CURRENT CARDINAL GLASS SPECS
LITES WITH SHAPES, ANGLES, OR RADII OUTSIDE THE LISEC BENDER
CAPABILITIES FOR STAINLESS STEEL WARM EDGE SPACER WILL HAVE
ALUMINUM BOX SPACER WITH THE SAME AIRSPACE DIMENSION SHOWN HERE

**UNIT SIZING, ROUGH OPENINGS
& MASONRY OPENINGS**

STANDARD OFFERING

DRIP CAP & NAILING FLANGE

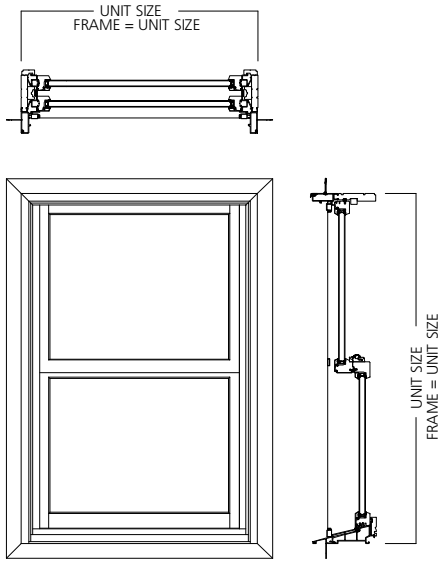

GENERAL NOTES:

UNITS WITH NO TRIM AND SILL NOSE:
UNIT SIZE = FRAME SIZE

UNIT SIZE IS ALWAYS THE
EXTREME SIZE OF THE WINDOW
WITH OR WITHOUT TRIM
(DRIP CAP & NAILING FLANGE ARE
NOT ADDED TO ANY UNIT SIZING)

MASONRY OPENING:

MASONRY OPENING IS ALWAYS 1/2" OVER
THE UNIT SIZE OF THE WINDOW

ROUGH OPENING:

ROUGH OPENING IS ALWAYS 3/4" OVER
FRAME SIZE OF THE WINDOW

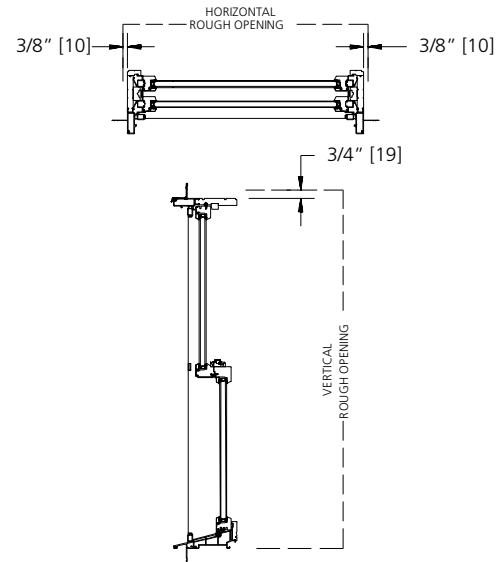

NON-STANDARD UNIT SIZING

EXTERIOR TRIM MUST USE SILL NOSE

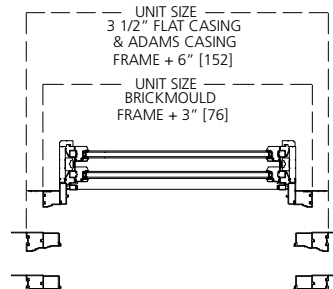
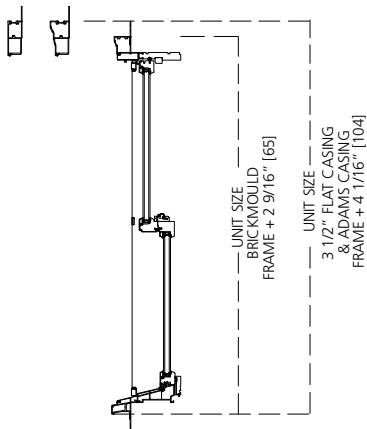

**FRAME TO TRIM
DIMENSIONS**

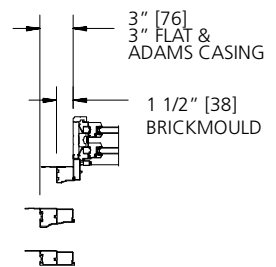

TYPICAL FOR HEAD & SIDES

CLEAR OPENING LAYOUT
DP35 SILL

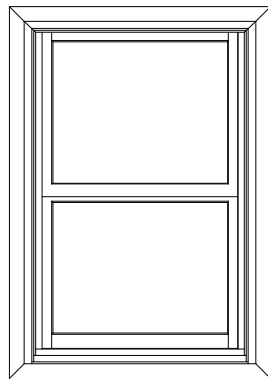
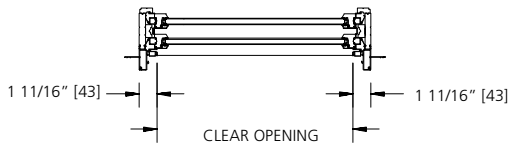

DOUBLE HUNG WINDOW

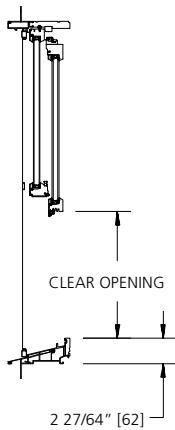

DOUBLE HUNG
CLEAR OPENING FORMULA

VERTICAL

$(\text{Frame Height} / 2) - 3 \text{ 15/16}'' = \text{Clear Opening}$

HORIZONTAL

$\text{Frame Width} - 3 \text{ 3/8}'' = \text{Clear Opening}$

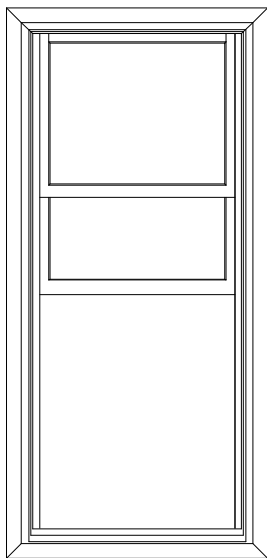

COTTAGE WINDOW

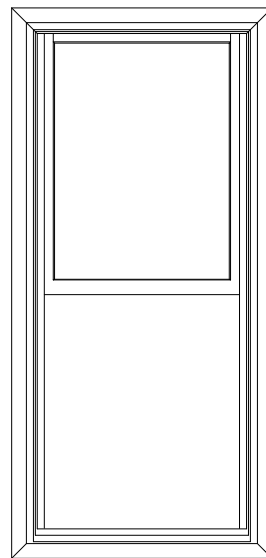
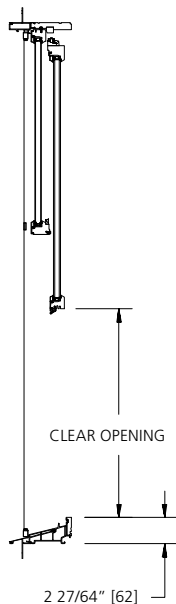

REVERSE COTTAGE WINDOW

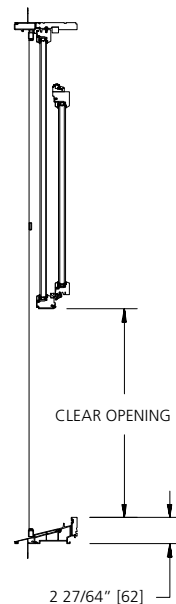

COTTAGE & REVERSE COTTAGE

Consult the Design Data Tables for clear opening information. For dimensional units, contact Jeld-Wen - Bend Window Division, Technical Services Department for clear opening information.

SINGLE UNITS

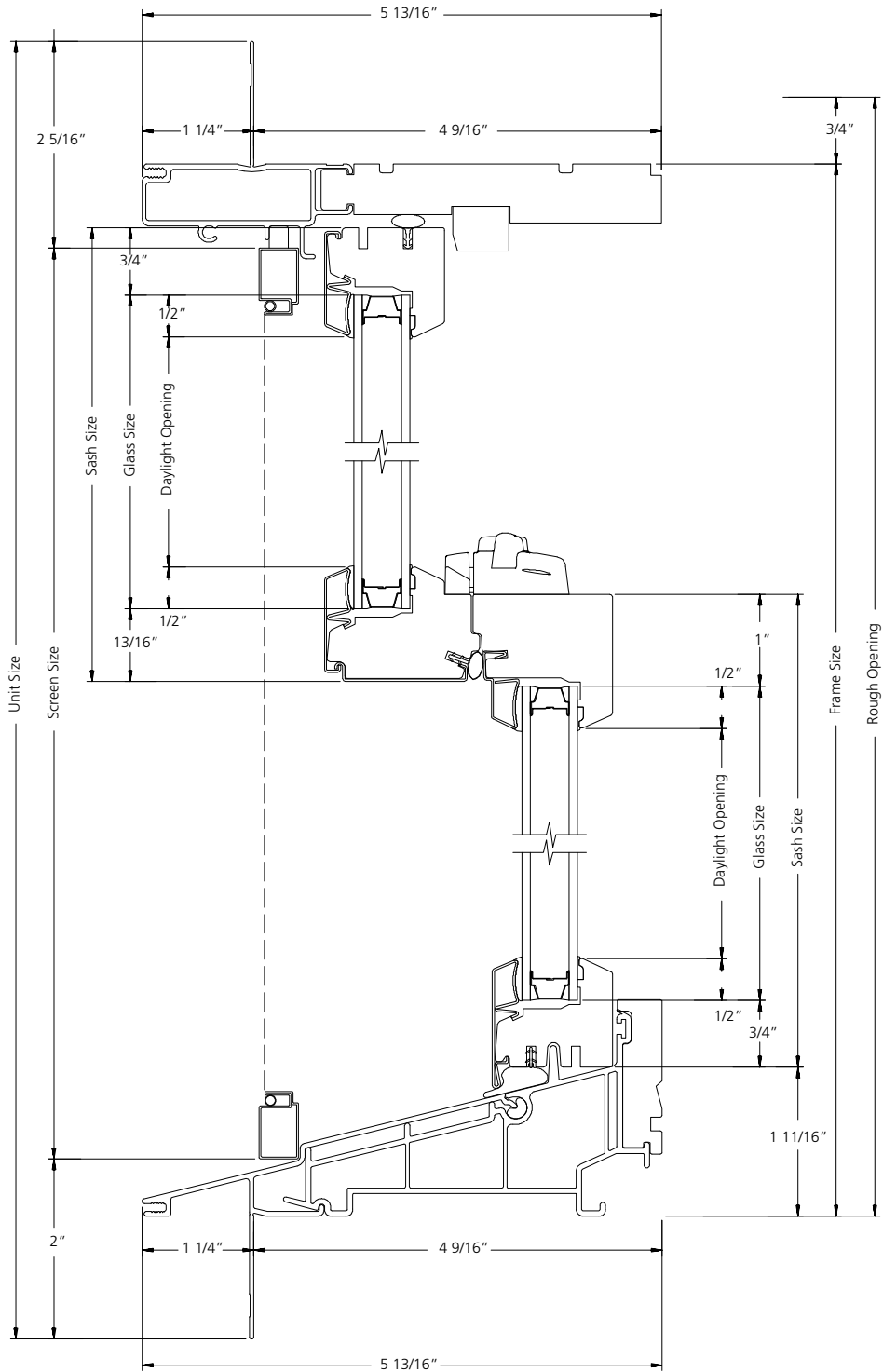

VERTICAL SECTION

SCALE: 6" = 1'

SINGLE UNITS

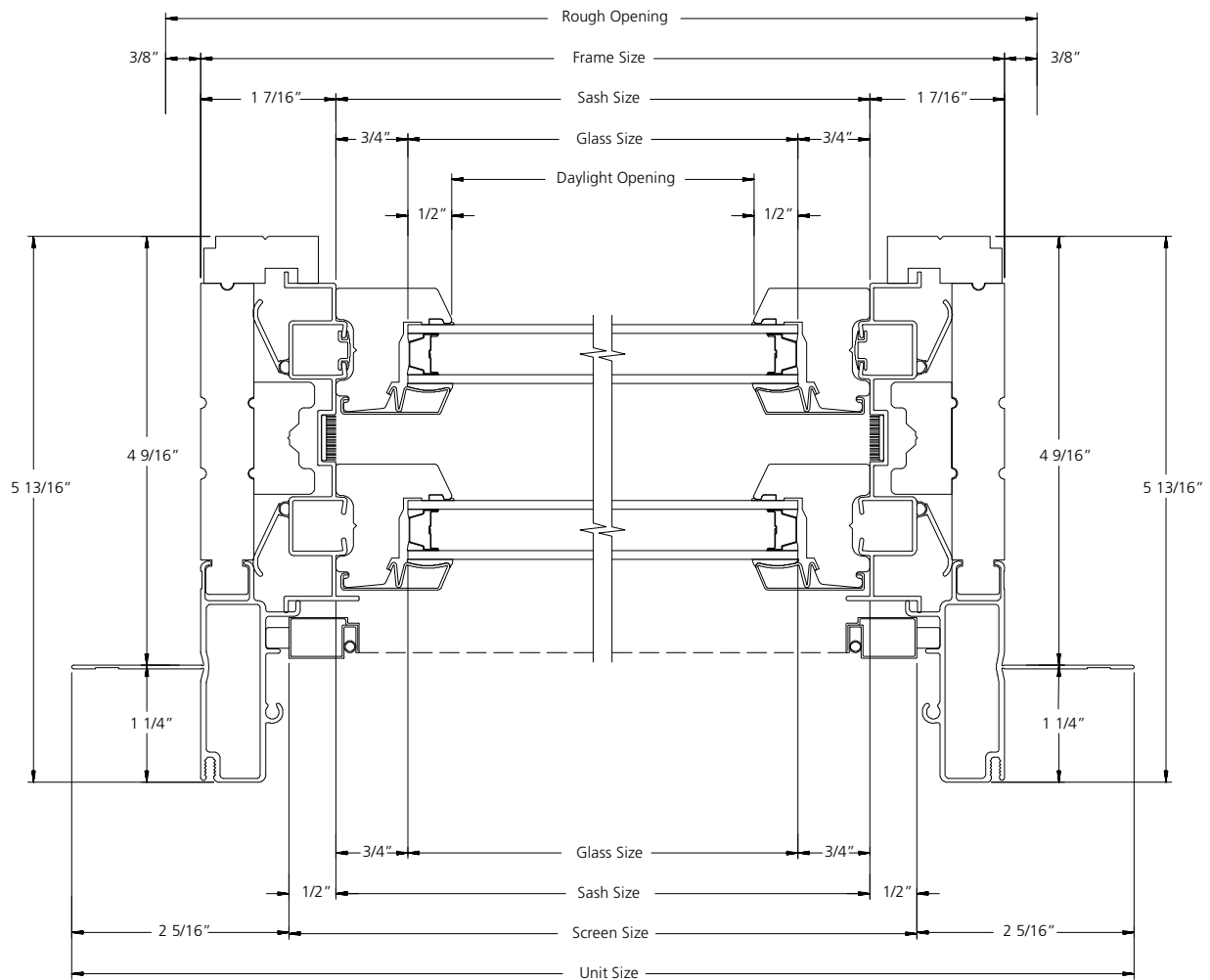

HORIZONTAL SECTION

SCALE: 6" = 1'

**DOUBLE-HUNG UNITS
 WITH CONCEALED JAMB LINER**

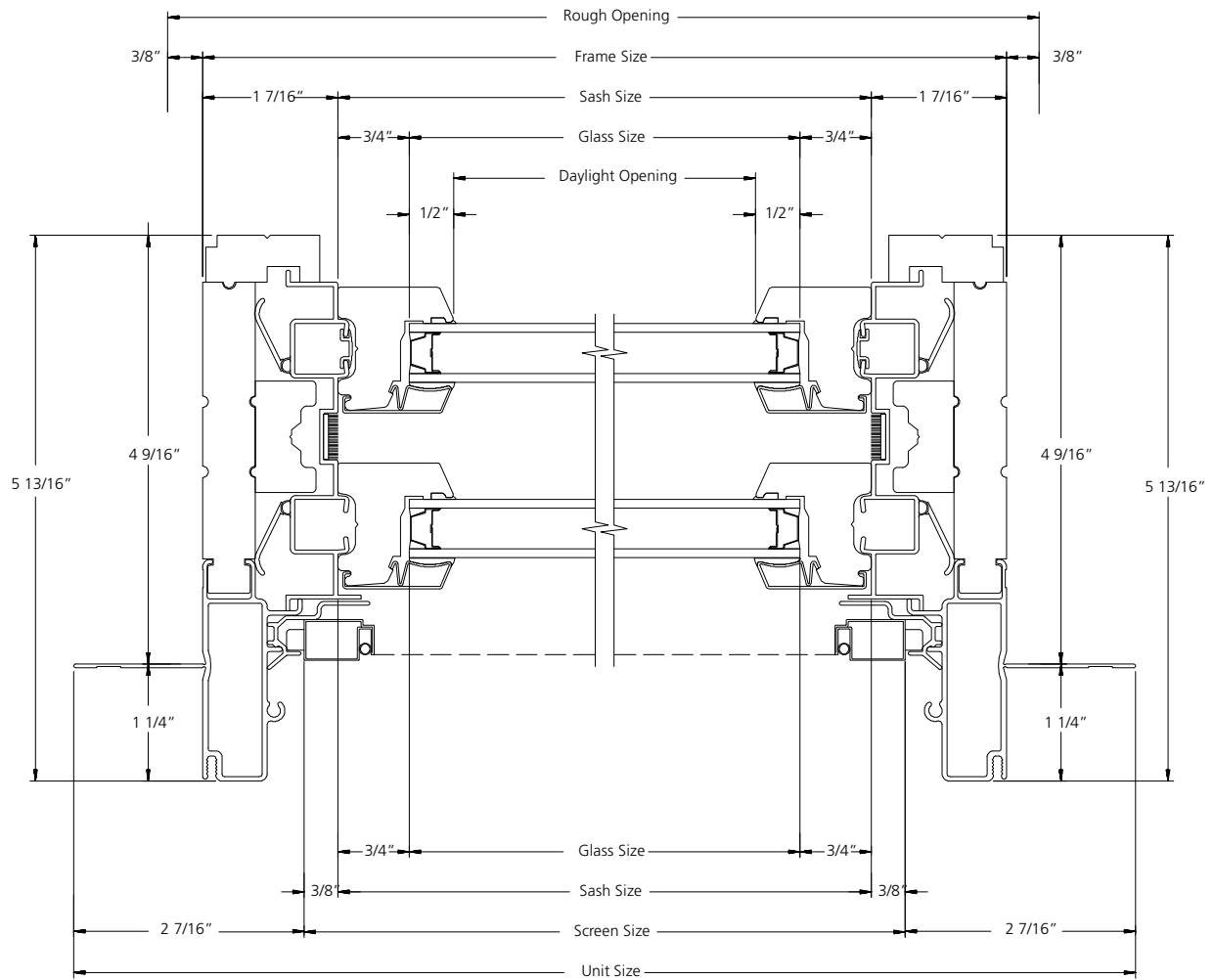

HORIZONTAL SECTION

SCALE: 6" = 1'

**DOUBLE-HUNG UNITS
 WITH TRADITIONAL SASH PACK**

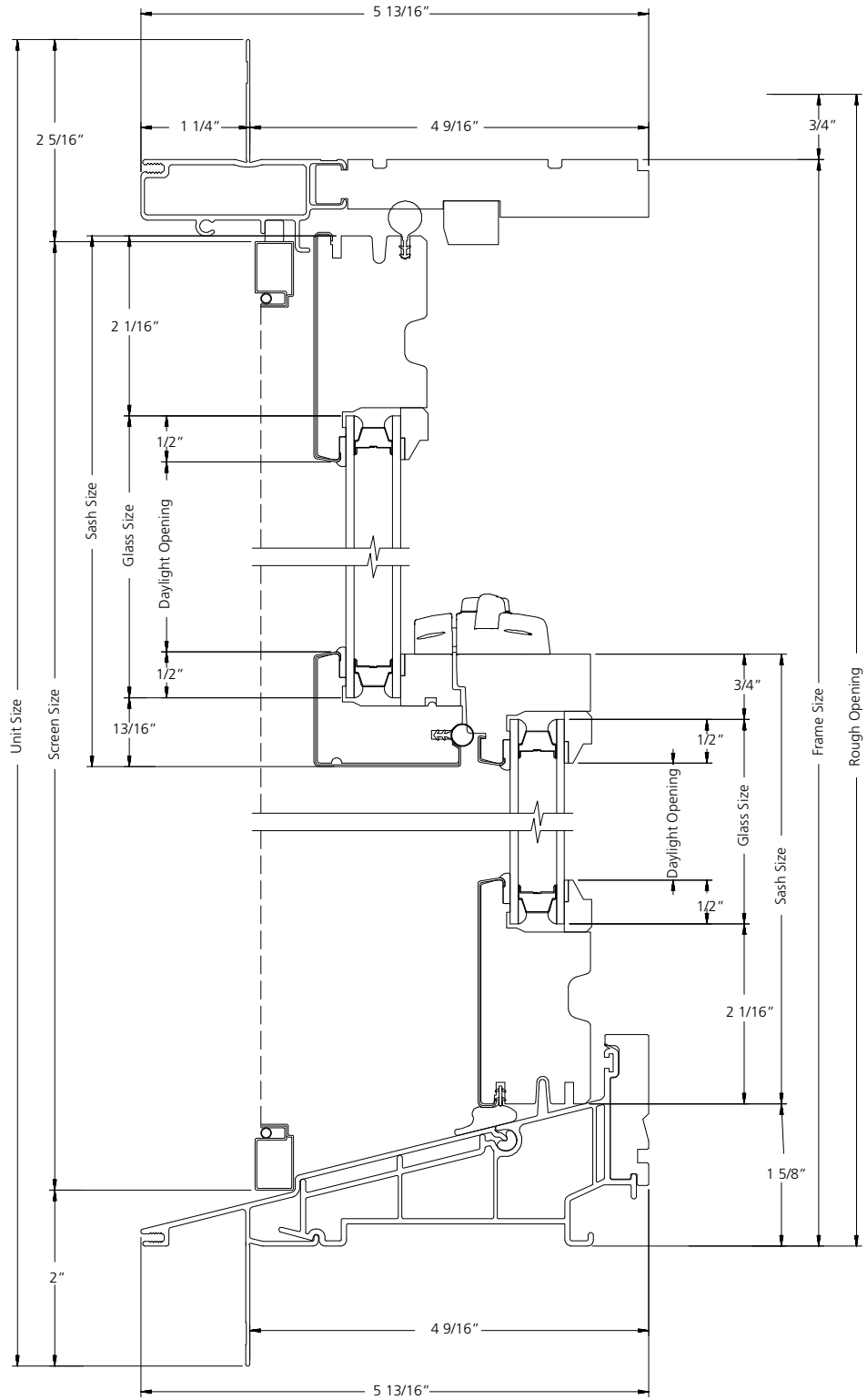

VERTICAL SECTION

SCALE: 6" = 1'

**DOUBLE-HUNG UNITS
 WITH TRADITIONAL SASH PACK**

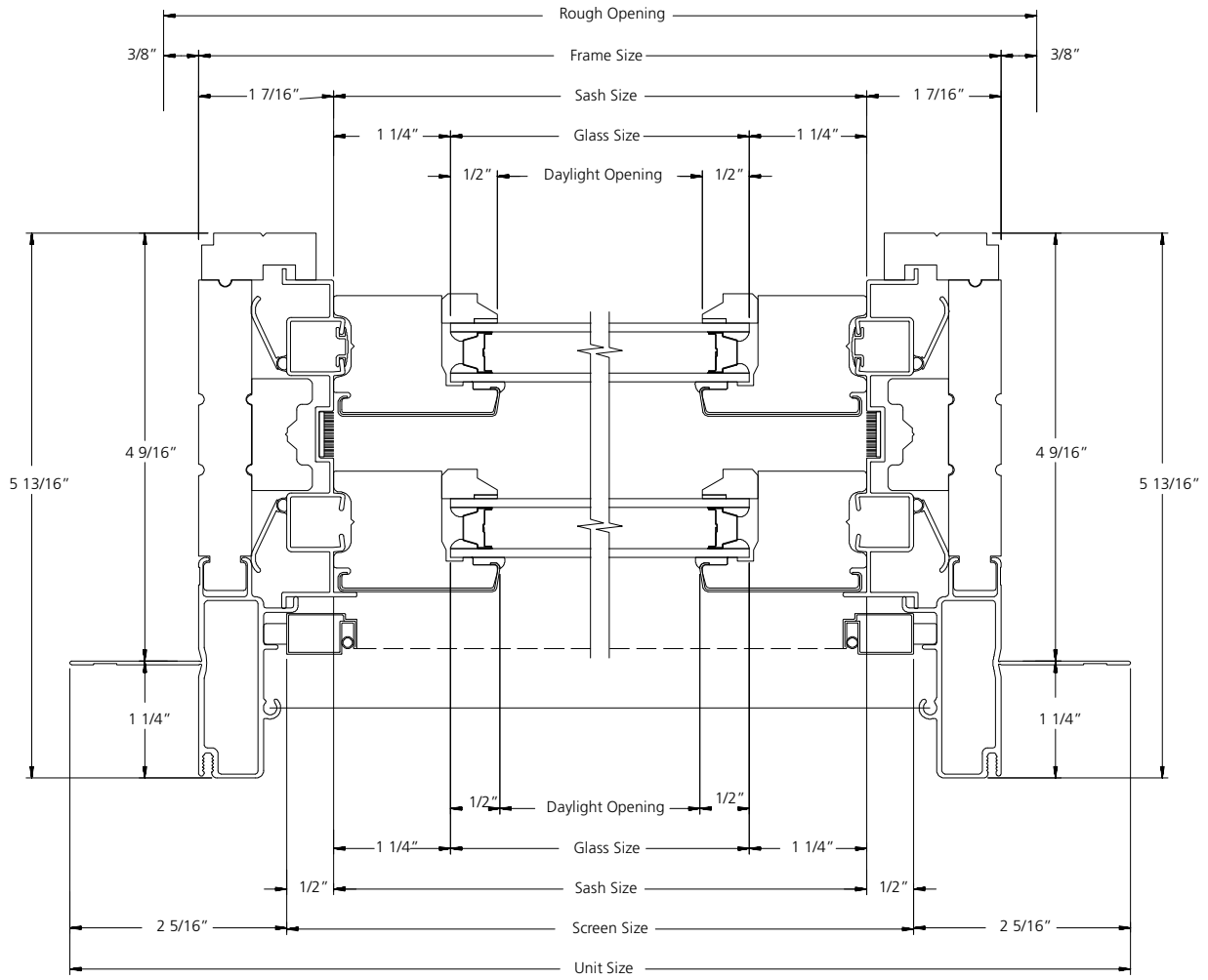

HORIZONTAL SECTION

SCALE: 6" = 1'

DOUBLE-HUNG UNITS - MULLION

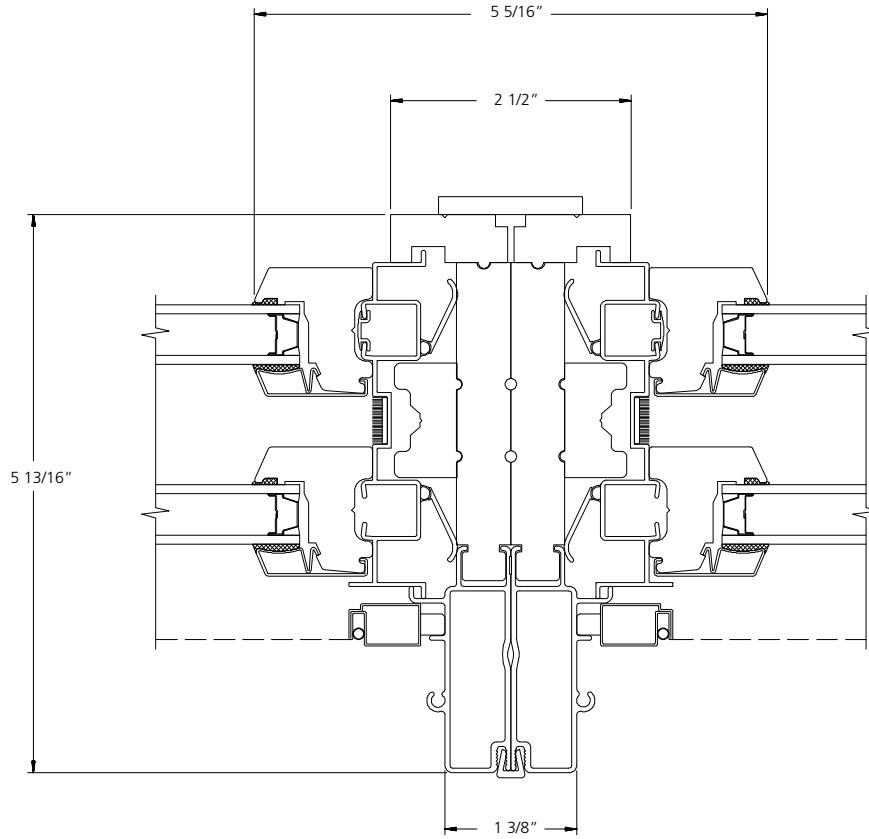

HORIZONTAL SECTION

SCALE: 6" = 1'

IN-SASH PICTURE/TRANSOM

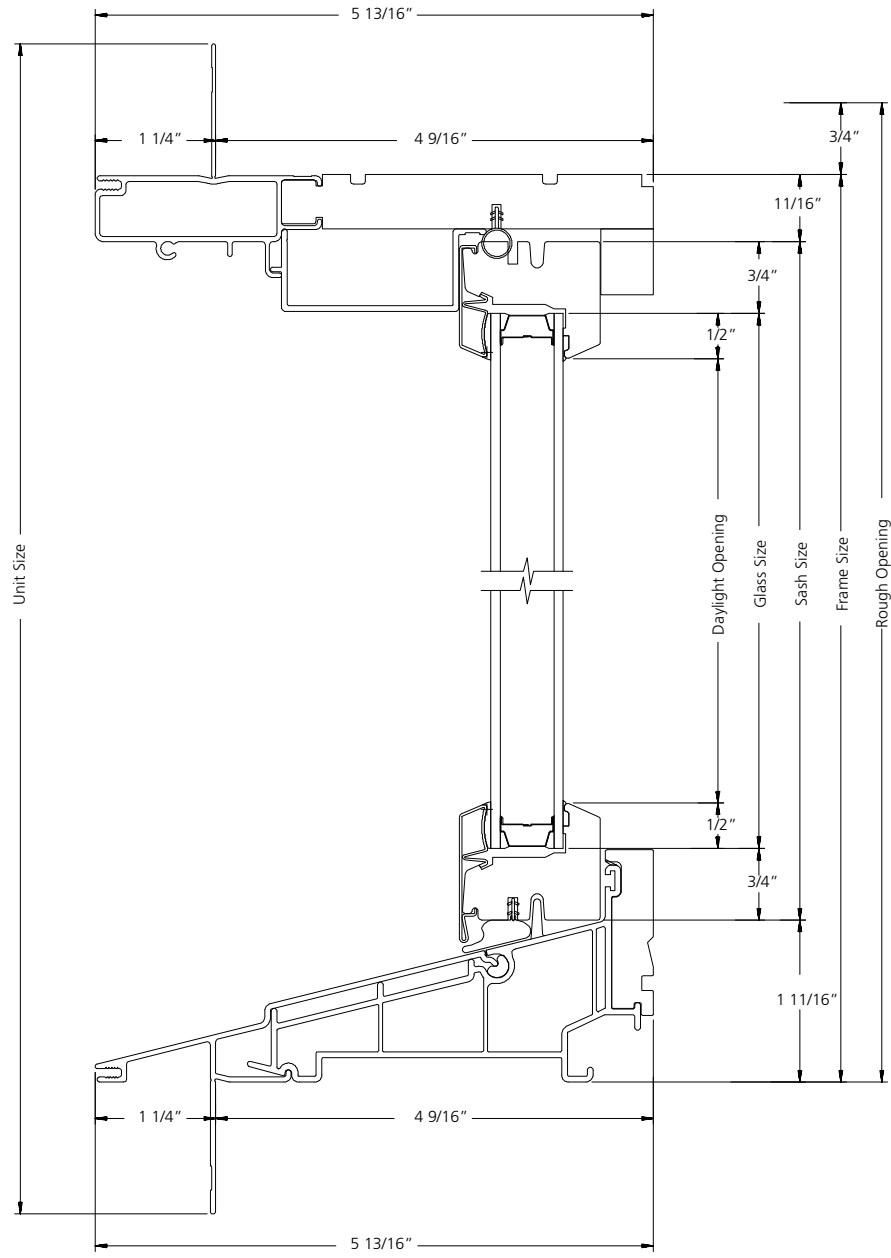

VERTICAL SECTION

SCALE: 6" = 1'

IN-SASH PICTURE/TRANSOM

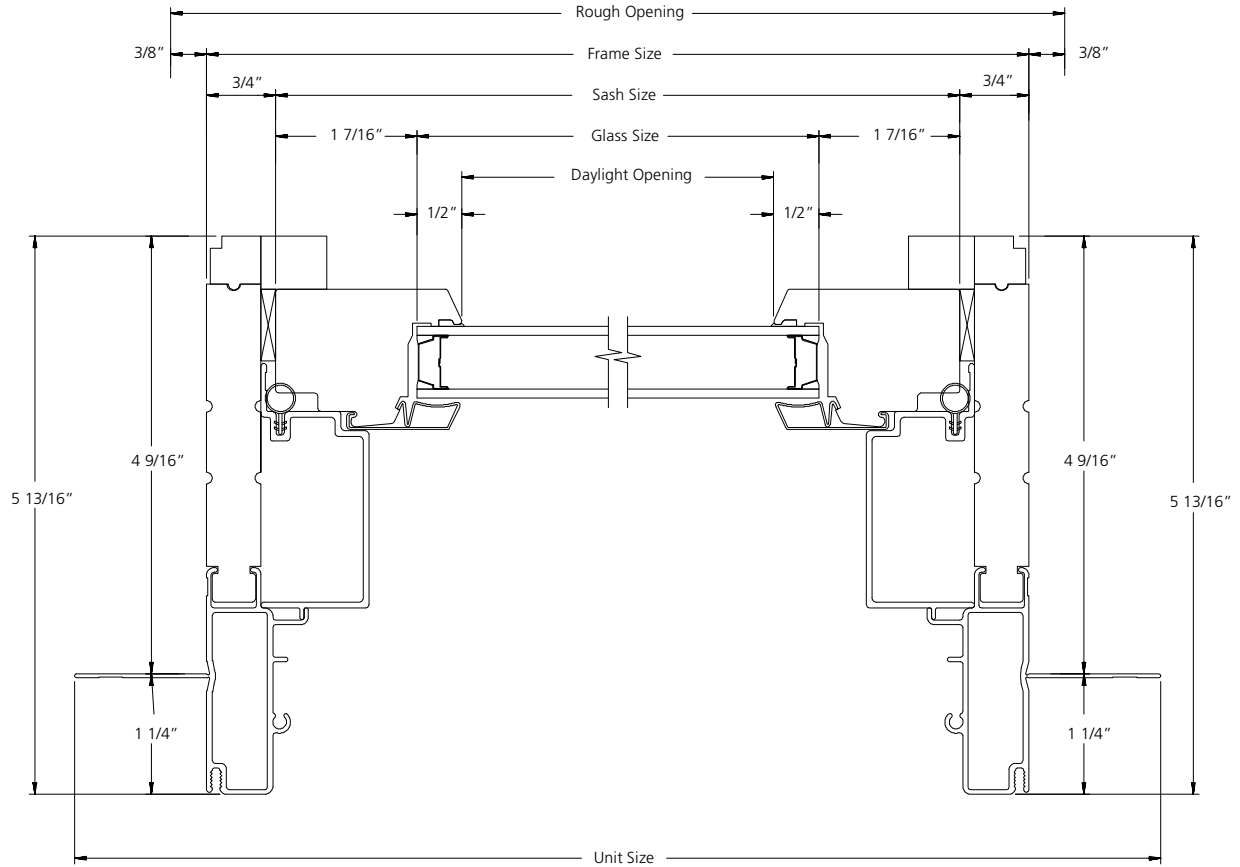

HORIZONTAL SECTION

SCALE: 6" = 1'

**IN-SASH PICTURE/TRANSOM
MULLION**

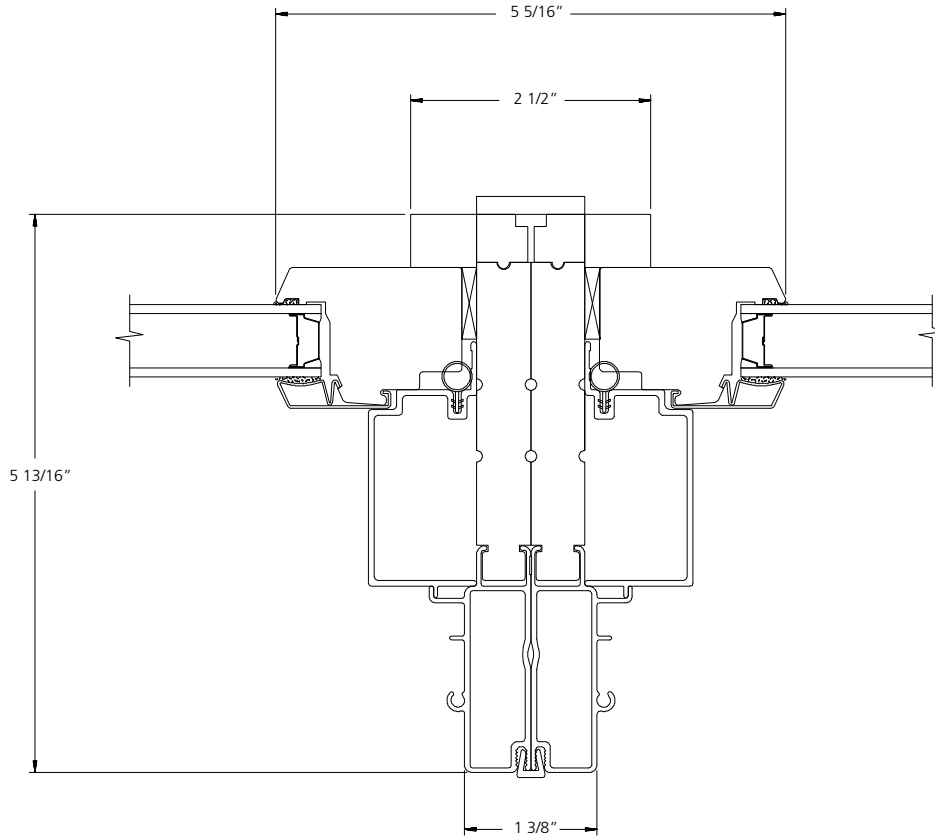

HORIZONTAL SECTION