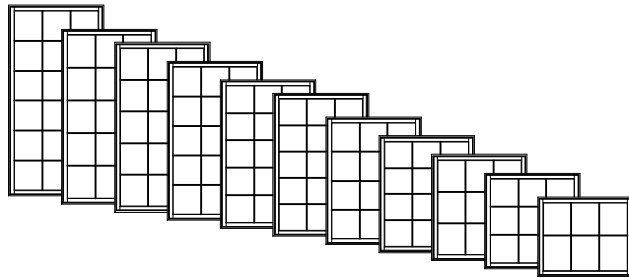

TABLE OF CONTENTS

General Information	1-2
Elevations/Sizes: 1/4" & 1/8" Scale	
Casement	1-5
2-Wide Casement	1-18
3-Wide Casement	1-26
4-Wide Casement	1-34
5-Wide Casement	1-36
Casement Picture	1-38
Casement Transom	1-54
Casement Radius	1-59
Glazing Options	1-62
Trim Options	1-63
Jamb Extender Options	1-64
Standard Mullion Options	1-65
Lite Cut Information	1-66
Unit Sizing Information	1-68
Section Details	1-69

GENERAL INFORMATION
CASEMENT



Clad casement windows are available with left or right hand operation, or stationary (non-venting). Operating mechanism includes corrosion resistant steel hinges and dual arm roto-type operator with hardened steel gears and operating arms. Sash locks are concealed unison type with an exposed locking lever and escutcheon plate. There are several interior hardware finish options. Refer to the Specifications for finish options. An optional traditional sash can be specified in this window. Refer to the cross sections for more details.

MULTIPLE ASSEMBLIES

Clad casement windows may be mullied above, below, or beside other clad casement windows, or other clad window products. Factory assembled mulls are limited in height (100"), width (150"), and a total area (75 square feet).

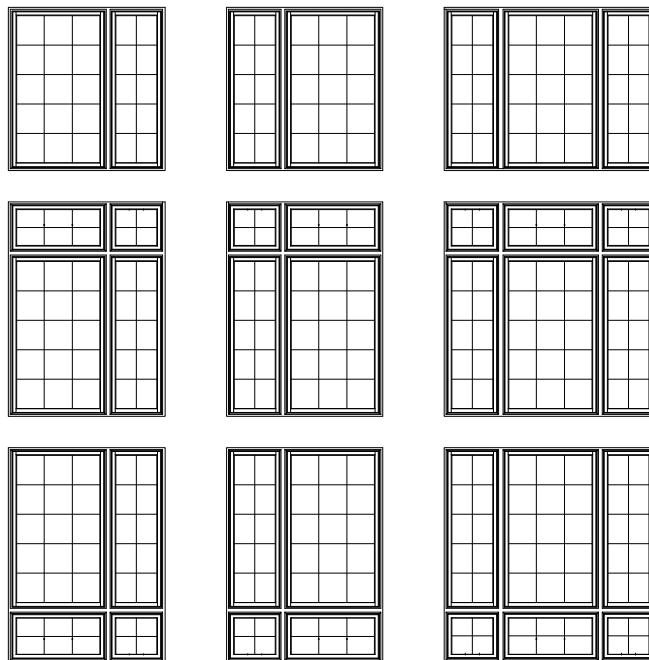

**HANDING & OPERATION
CASEMENT**

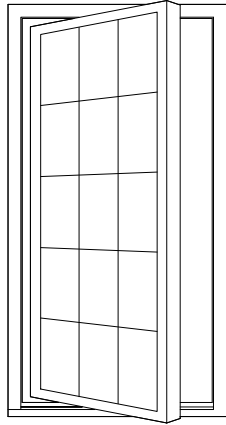

**LEFT
HAND**

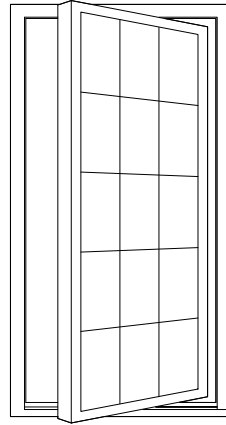

**RIGHT
HAND**

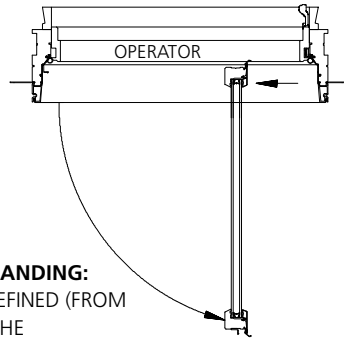
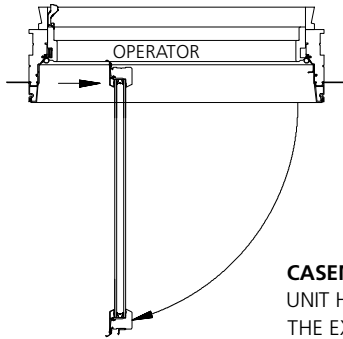

CASEMENT UNIT HANDING:
UNIT HANDING IS DEFINED (FROM
THE EXTERIOR) AS THE
DIRECTION THE SASH OPENS.

ELEVATION NOTES
CASEMENT

ELEVATION DRAWINGS UTILIZE A LIMITED NUMBER OF PROJECTED LINES TO PRODUCE A RUDIMENTARY DRAWING INTENDED TO BE USED IN A SMALL GRAPHICAL SCALE. ELEVATIONS ARE VIEWED PERPENDICULAR FROM THE EXTERIOR OF THE STRUCTURE. IF MORE DIMENSIONS ARE NEEDED, USE THE SECTION DRAWINGS FOR MORE COMPLETE DEPICTIONS.

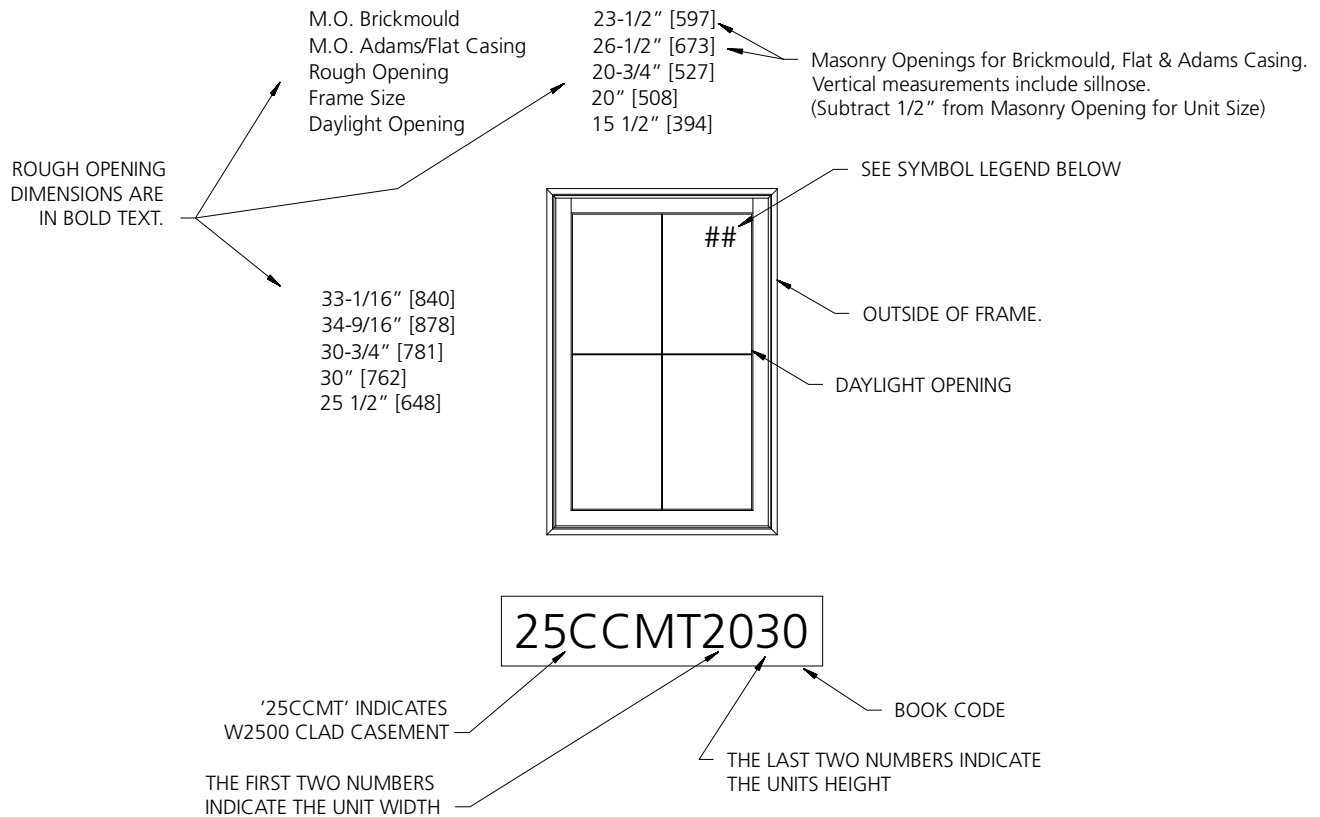

GENERAL CASEMENT NOTES

1. W-2500 CLAD CASEMENT 25CCMTC) UNITS ARE AVAILABLE AS OPERATING OR STATIONARY UNITS.
2. 25CCMTP' IN A BOOK CODE DENOTES THE UNIT IS A CLAD CASEMENT PICTURE (STATIONARY) UNIT.
3. UNIT ELEVATIONS ARE SHOWN WITHOUT EXTERIOR TRIM. UNIT SIZES & MASONRY OPENING DIMENSIONS WILL CHANGE WITH THE ADDITION OF EXTERIOR TRIM. SEE THE 'UNIT SIZING, ROUGH OPENINGS & MASONRY OPENINGS' PAGE FOR EXTERIOR TRIM EFFECTS.
4. OPERATING UNITS ARE AVAILABLE AS LEFT OR RIGHT HAND OPERATION.
5. DIMENSIONAL VALUES IN PARENTHESES ARE MILLIMETER CONVERSIONS.

ELEVATION SYMBOL LEGEND:

M.O. MASONRY OPENING

1-WIDE UNITS

UNIT SIZE
ROUGH OPENING
FRAME SIZE
DAYLIGHT OPENING

22 3/4" (578)
20 3/4" (527)
20" (508)
15 1/2" (394)

26 3/4" (680)
24 3/4" (629)
24" (609)
19 1/2" (495)

30 3/4" (781)
28 3/4" (730)
28" (711)
23 1/2" (597)

32 3/4" (832)
30 3/4" (781)
30" (762)
25 1/2" (648)

38 3/4" (984)
36 3/4" (933)
36" (914)
31 1/2" (800)

32 3/4" (832)
30 3/4" (781)
30" (762)
25 1/2" (648)

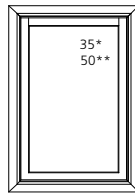

25CCMT2030

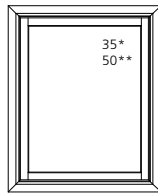

25CCMT2430

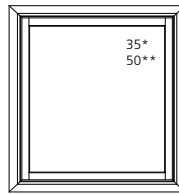

25CCMT2830

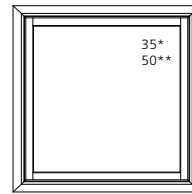

25CCMT3030

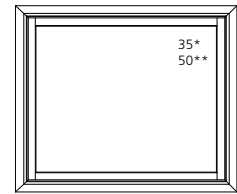

25CCMT3630

38 3/4" (984)
36 3/4" (934)
36" (914)
31 1/2" (800)

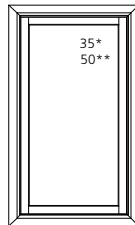

25CCMT2036

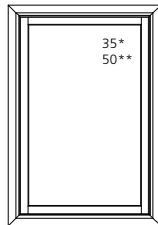

25CCMT2436

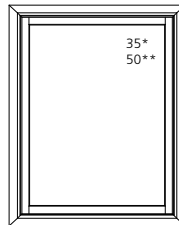

25CCMT2836

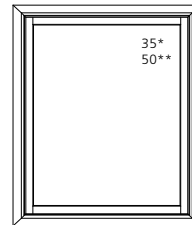

25CCMT3036

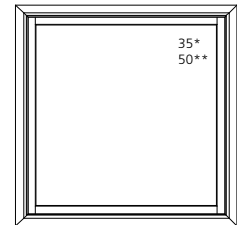

25CCMT3636

42 3/4" (1086)
40 3/4" (1035)
40" (1016)
35 1/2" (902)

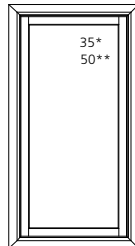

25CCMT2040

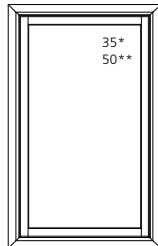

25CCMT2440

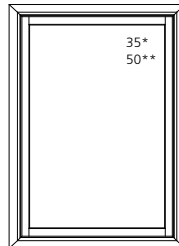

25CCMT2840

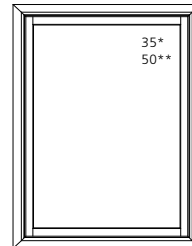

25CCMT3040

46 3/4" (1188)
44 3/4" (1137)
44" (1118)
39 1/2" (1003)

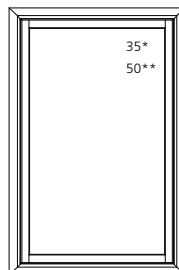

25CCMT2844

50 3/4" (1289)
48 3/4" (1238)
48" (1219)
43 1/2" (1105)

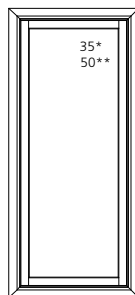

25CCMT2048

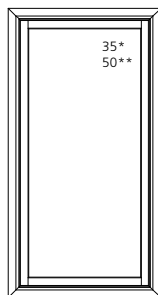

25CCMT2448

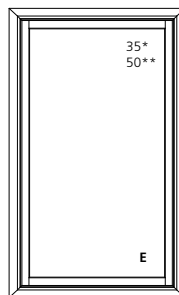

25CCMT2848

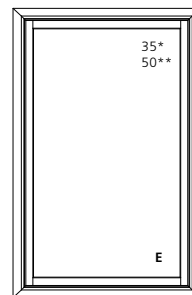

25CCMT3048

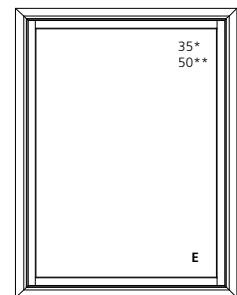

25CCMT3648

ELEVATION SYMBOL LEGEND:

VALUES IN () ARE IN MILLIMETER CONVERSIONS.

##* NUMBER INDICATES DESIGN PRESSURE (DP) RATING WITH STANDARD GLAZING.

##** NUMBER INDICATES OPTIONAL DESIGN PRESSURE (DP) RATING.

E UNIT MEETS EGRESS REQUIREMENTS FOR IRC CODE. STATE AND LOCAL EGRESS CODES MAY DIFFER. ALWAYS REFER TO LOCAL BUILDING CODES FOR COMPLETE REQUIREMENTS. CHECK WITH LOCAL OFFICIALS TO ENSURE COMPLIANCE BEFORE INSTALLING THE UNIT.

SCALE: 1/4" = 1'

1-WIDE UNITS

UNIT SIZE	22 3/4" (578)	26 3/4" (680)	30 3/4" (781)	32 3/4" (832)	38 3/4" (984)	
ROUGH OPENING	20 3/4" (527)	24 3/4" (629)	28 3/4" (730)	30 3/4" (781)	36 3/4" (933)	
FRAME SIZE	20" (508)	24" (609)	28" (711)	30" (762)	36" (914)	
DAYLIGHT OPENING	15 1/2" (394)	19 1/2" (495)	23 1/2" (597)	25 1/2" (648)	31 1/2" (800)	
56 3/4" (1442) 54 3/4" (1391) 54" (1372) 49 1/2" (1257)						
	25CCMT2054	25CCMT2454	25CCMT2854	25CCMT3054	25CCMT3654	
	58 3/4" (1492) 56 3/4" (1442) 56" (1422) 51 1/2" (1308)					
		25CCMT2056	25CCMT2456	25CCMT2856	25CCMT3056	
		62 3/4" (1594) 60 3/4" (1543) 60" (1524) 55 1/2" (1410)				
25CCMT2060			25CCMT2460	25CCMT2860	25CCMT3060	25CCMT3660
66 3/4" (1696) 64 3/4" (1645) 64" (1626) 59 1/2" (1511)						
	25CCMT2064		25CCMT2464	25CCMT2864	25CCMT3064	

ELEVATION SYMBOL LEGEND:

VALUES IN () ARE IN MILLIMETER CONVERSIONS.

NUMBER INDICATES DESIGN PRESSURE (DP) RATING WITH STANDARD GLAZING.

NUMBER INDICATES OPTIONAL DESIGN PRESSURE (DP) RATING.

E UNIT MEETS EGRESS REQUIREMENTS FOR IRC CODE. STATE AND LOCAL EGRESS CODES MAY DIFFER. ALWAYS REFER TO LOCAL BUILDING CODES FOR COMPLETE REQUIREMENTS. CHECK WITH LOCAL OFFICIALS TO ENSURE COMPLIANCE BEFORE INSTALLING THE UNIT.

SCALE: 1/4" = 1'

1-WIDE UNITS



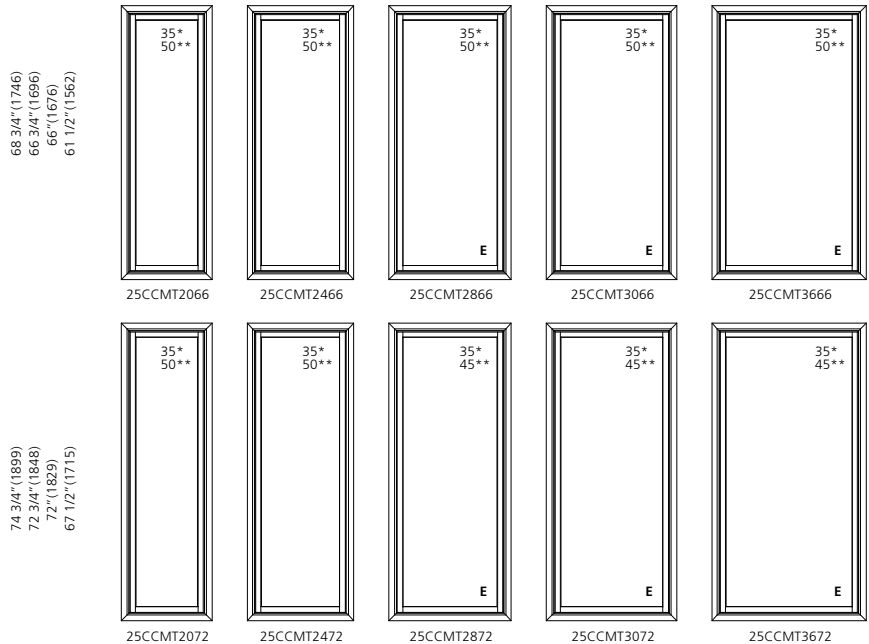



UNIT SIZE	22 3/4" (578)	26 3/4" (680)	30 3/4" (781)	32 3/4" (832)	38 3/4" (984)
ROUGH OPENING	20 3/4" (527)	24 3/4" (629)	28 3/4" (730)	30 3/4" (781)	36 3/4" (933)
FRAME SIZE	20" (508)	24" (609)	28" (711)	30" (762)	36" (914)
DAYLIGHT OPENING	15 1/2" (394)	19 1/2" (495)	23 1/2" (597)	25 1/2" (648)	31 1/2" (800)

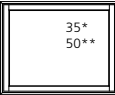
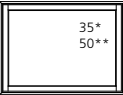
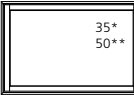
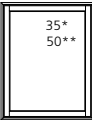

ELEVATION SYMBOL LEGEND:
 VALUES IN () ARE IN MILLIMETER CONVERSIONS.
 ### NUMBER INDICATES DESIGN PRESSURE (DP) RATING WITH STANDARD GLAZING.
 #### NUMBER INDICATES OPTIONAL DESIGN PRESSURE (DP) RATING.
 E UNIT MEETS EGRESS REQUIREMENTS FOR IRC CODE. STATE AND LOCAL EGRESS CODES MAY DIFFER. ALWAYS REFER TO LOCAL BUILDING CODES FOR COMPLETE REQUIREMENTS. CHECK WITH LOCAL OFFICIALS TO ENSURE COMPLIANCE BEFORE INSTALLING THE UNIT.

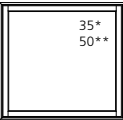
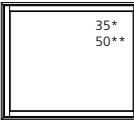
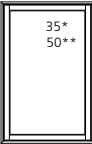
SCALE: 1/4" = 1'

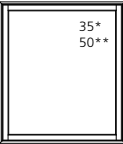
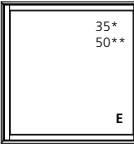
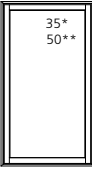
1-WIDE UNITS - NOMINAL

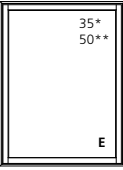
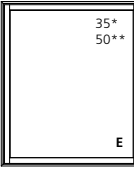
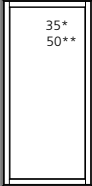
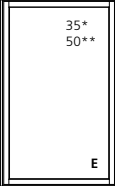
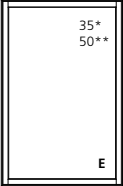
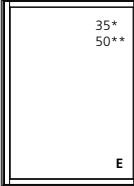
UNIT SIZE	26" (660)	32" (813)	34" (864)	38" (965)
ROUGH OPENING	24" (610)	30" (762)	32" (813)	36" (914)
FRAME SIZE	23 1/4" (591)	29 1/4" (743)	31 1/4" (794)	35 1/4" (895)
DAYLIGHT OPENING	18 3/4" (476)	24 3/4" (629)	26 3/4" (679)	30 3/4" (781)
26" (660) 24" (610) 23 1/4" (591) 18 3/4" (476)	 35* 50**	 35* 50**	 35* 50**	 35* 50**
	25CCMT2424N	25CCMT3024N	25CCMT3224N	25CCMT3624N
32" (813) 30" (762) 29 1/4" (743) 24 3/4" (629)	 35* 50**	 35* 50**	 35* 50**	 35* 50**
	25CCMT2430N	25CCMT3030N	25CCMT3230N	25CCMT3630N
38" (965) 36" (914) 35 1/4" (895) 30 3/4" (781)	 35* 50**	 35* 50**	 35* 50**	 35* 50** E
	25CCMT2436N	25CCMT3036N	25CCMT3236N	25CCMT3636N
44" (1118) 42" (1067) 41 1/4" (1048) 36 3/4" (933)	 35* 50**	 35* 50**	 35* 50** E	 35* 50** E
	25CCMT2442N	25CCMT3042N	25CCMT3242N	25CCMT3642N
50" (1270) 48" (1219) 47 1/4" (1200) 42 3/4" (1086)	 35* 50**	 35* 50** E	 35* 50** E	 35* 50** E
	25CCMT2448N	25CCMT3048N	25CCMT3248N	25CCMT3648N

ELEVATION SYMBOL LEGEND:

VALUES IN () ARE IN MILLIMETER CONVERSIONS.

##* NUMBER INDICATES DESIGN PRESSURE (DP) RATING WITH STANDARD GLAZING.

##** NUMBER INDICATES OPTIONAL DESIGN PRESSURE (DP) RATING.

E UNIT MEETS EGRESS REQUIREMENTS FOR IRC CODE. STATE AND LOCAL EGRESS CODES MAY DIFFER. ALWAYS REFER TO LOCAL BUILDING CODES FOR COMPLETE REQUIREMENTS. CHECK WITH LOCAL OFFICIALS TO ENSURE COMPLIANCE BEFORE INSTALLING THE UNIT.

SCALE: 1/4" = 1'

1-WIDE UNITS - NOMINAL

	UNIT SIZE ROUGH OPENING FRAME SIZE DAYLIGHT OPENING	26" (660) 24" (610) 23 1/4" (591) 18 3/4" (476)	32" (813) 30" (762) 29 1/4" (743) 24 3/4" (629)	34" (864) 32" (813) 31 1/4" (974) 26 3/4" (679)	38" (965) 36" (914) 35 1/4" (895) 30 3/4" (781)
56" (1422) 54" (1372) 53 1/4" (1353) 48 3/4" (1238)	35* 50**		35* 50**	35* 50**	35* 50**
25CCMT2454N		25CCMT3054N		25CCMT3254N	25CCMT3654N
62" (1575) 60" (1524) 59 1/4" (1505) 54 3/4" (1391)	35* 50**		35* 50**	35* 50**	35* 50**
25CCMT2460N		25CCMT3060N		25CCMT3260N	25CCMT3660N
68" (1727) 66" (1676) 65 1/4" (1657) 60 3/4" (1543)	35* 50**		35* 50**	35* 50**	35* 50**
25CCMT2466N		25CCMT3066N		25CCMT3266N	25CCMT3666N
74" (1880) 72" (1829) 71 1/4" (1810) 66 3/4" (1695)	35* 50**		35* 45**	35* 45**	35* 45**
25CCMT2472N		25CCMT3072N		25CCMT3272N	25CCMT3672N

ELEVATION SYMBOL LEGEND:

VALUES IN () ARE IN MILLIMETER CONVERSIONS.

##* NUMBER INDICATES DESIGN PRESSURE (DP) RATING WITH STANDARD GLAZING.

###* NUMBER INDICATES OPTIONAL DESIGN PRESSURE (DP) RATING.

E UNIT MEETS EGRESS REQUIREMENTS FOR IRC CODE. STATE AND LOCAL EGRESS CODES MAY DIFFER. ALWAYS REFER TO LOCAL BUILDING CODES FOR COMPLETE REQUIREMENTS. CHECK WITH LOCAL OFFICIALS TO ENSURE COMPLIANCE BEFORE INSTALLING THE UNIT.

SCALE: 1/4" = 1'

**1-WIDE UNITS
WITH 15" TRANSOM**

UNIT SIZE	22 3/4" (578)	26 3/4" (680)	30 3/4" (781)	32 3/4" (832)	38 3/4" (984)
ROUGH OPENING	20 3/4" (527)	24 3/4" (629)	28 3/4" (730)	30 3/4" (781)	36 3/4" (933)
FRAME SIZE	20" (508)	24" (609)	28" (711)	30" (762)	36" (914)
DAYLIGHT OPENING	15 1/2" (394)	19 1/2" (495)	23 1/2" (597)	25 1/2" (648)	31 1/2" (800)

47 3/4" (1213) 45 3/4" (1162) 45" (1143) 25 1/2" (648) 10 1/2" (267)					
	25CCMT2030-1T15	25CCMT2430-1T15	25CCMT2830-1T15	25CCMT3030-1T15	25CCMT3630-1T15
53 3/4" (1365) 51 3/4" (1314) 51" (1295) 31 1/2" (800) 10 1/2" (267)					
	25CCMT2036-1T15	25CCMT2436-1T15	25CCMT2836-1T15	25CCMT3036-1T15	25CCMT3636-1T15
57 3/4" (1467) 55 3/4" (1416) 55" (1397) 35 1/2" (902) 10 1/2" (267)					
	25CCMT2040-1T15	25CCMT2440-1T15	25CCMT2840-1T15	25CCMT3040-1T15	25CCMT3640-1T15
61 3/4" (1568) 59 3/4" (1518) 59" (1499) 39 1/2" (1003) 10 1/2" (267)					
	25CCMT2044-1T15	25CCMT2444-1T15	25CCMT2844-1T15	25CCMT3044-1T15	25CCMT3644-1T15
65 3/4" (1670) 63 3/4" (1619) 63" (1600) 43 1/2" (1105) 10 1/2" (267)					
	25CCMT2048-1T15	25CCMT2448-1T15	25CCMT2848-1T15	25CCMT3048-1T15	25CCMT3648-1T15
71 3/4" (1822) 69 3/4" (1772) 69" (1753) 49 1/2" (1257) 10 1/2" (267)					
	25CCMT2054-1T15	25CCMT2454-1T15	25CCMT2854-1T15	25CCMT3054-1T15	25CCMT3654-1T15
73 3/4" (1873) 71 3/4" (1822) 71" (1803) 51 1/2" (1308) 10 1/2" (267)					
	25CCMT2056-1T15	25CCMT2456-1T15	25CCMT2856-1T15	25CCMT3056-1T15	25CCMT3656-1T15
77 3/4" (1975) 75 3/4" (1924) 75" (1905) 55 1/2" (1410) 10 1/2" (267)					
	25CCMT2060-1T15	25CCMT2460-1T15	25CCMT2860-1T15	25CCMT3060-1T15	25CCMT3660-1T15

ELEVATION SYMBOL LEGEND:
VALUES IN () ARE IN MILLIMETER CONVERSIONS.

E UNIT MEETS EGRESS REQUIREMENTS FOR IRC CODE. STATE AND LOCAL EGRESS CODES MAY DIFFER. ALWAYS REFER TO LOCAL BUILDING CODES FOR COMPLETE REQUIREMENTS. CHECK WITH LOCAL OFFICIALS TO ENSURE COMPLIANCE BEFORE INSTALLING THE UNIT.

SCALE: 1/8" = 1'

**1-WIDE UNITS
WITH 15" TRANSOM**

UNIT SIZE	22 3/4" (578)	26 3/4" (680)	30 3/4" (781)	32 3/4" (832)	38 3/4" (984)
ROUGH OPENING	20 3/4" (527)	24 3/4" (629)	28 3/4" (730)	30 3/4" (781)	36 3/4" (933)
FRAME SIZE	20" (508)	24" (609)	28" (711)	30" (762)	36" (914)
DAYLIGHT OPENING	15 1/2" (394)	19 1/2" (495)	23 1/2" (597)	25 1/2" (648)	31 1/2" (800)

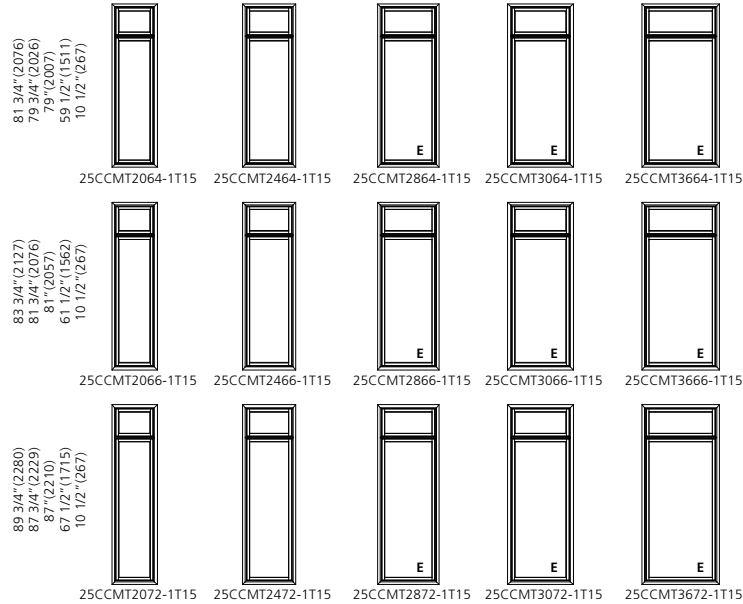

























ELEVATION SYMBOL LEGEND:
VALUES IN () ARE IN MILLIMETER CONVERSIONS.

E UNIT MEETS EGRESS REQUIREMENTS FOR IRC CODE. STATE AND LOCAL EGRESS CODES MAY DIFFER. ALWAYS REFER TO LOCAL BUILDING CODES FOR COMPLETE REQUIREMENTS. CHECK WITH LOCAL OFFICIALS TO ENSURE COMPLIANCE BEFORE INSTALLING THE UNIT.

SCALE: 1/8" = 1'

1-WIDE UNITS - NOMINAL WITH 18" TRANSOM

UNIT SIZE	26" (660)	32" (813)	38" (965)
ROUGH OPENING	24" (610)	30" (762)	36" (914)
FRAME SIZE	23 1/4" (591)	29 1/4" (743)	35 1/4" (895)
DAYLIGHT OPENING	18 3/4" (476)	24 3/4" (629)	30 3/4" (781)
49 1/4" (1251) 47 1/4" (1200) 46 1/2" (1181) 24 3/4" (629) 12 3/4" (324)	 25CCMT2430N-1T18	 25CCMT3030N-1T18	 25CCMT3630N-1T18
55 1/4" (1403) 53 1/4" (1353) 52 1/2" (1334) 30 3/4" (781) 12 3/4" (324)	 25CCMT2436N-1T18	 25CCMT3036N-1T18	 25CCMT3636N-1T18
61 1/4" (1556) 59 1/4" (1505) 58 1/2" (1486) 36 3/4" (933) 12 3/4" (324)	 25CCMT2442N-1T18	 25CCMT3042N-1T18	 25CCMT3642N-1T18
67 1/4" (1708) 65 1/4" (1657) 64 1/2" (1638) 42 3/4" (1086) 12 3/4" (324)	 25CCMT2448N-1T18	 25CCMT3048N-1T18	 25CCMT3648N-1T18
73 1/4" (1861) 71 1/4" (1810) 70 1/2" (1791) 48 3/4" (1238) 12 3/4" (324)	 25CCMT2454N-1T18	 25CCMT3054N-1T18	 25CCMT3654N-1T18
79 1/4" (2013) 77 1/4" (1962) 76 1/2" (1943) 54 3/4" (1391) 12 3/4" (324)	 25CCMT2460N-1T18	 25CCMT3060N-1T18	 25CCMT3660N-1T18
85 1/4" (2165) 83 1/4" (2115) 82 1/2" (2063) 60 3/4" (1543) 12 3/4" (324)	 25CCMT2466N-1T18	 25CCMT3066N-1T18	 25CCMT3666N-1T18
91 1/4" (2292) 89 1/4" (2241) 88 1/2" (2248) 66 3/4" (1695) 12 3/4" (324)	 25CCMT2472N-1T18	 25CCMT3072N-1T18	 25CCMT3672N-1T18

ELEVATION SYMBOL LEGEND:
VALUES IN () ARE IN MILLIMETER CONVERSIONS.

E UNIT MEETS EGRESS REQUIREMENTS FOR IRC CODE. STATE AND LOCAL EGRESS CODES MAY DIFFER. ALWAYS REFER TO LOCAL BUILDING CODES FOR COMPLETE REQUIREMENTS. CHECK WITH LOCAL OFFICIALS TO ENSURE COMPLIANCE BEFORE INSTALLING THE UNIT.

SCALE: 1/8" = 1'

**1-WIDE UNITS
WITH 24" TRANSOM**

UNIT SIZE	22 3/4" (578)	26 3/4" (680)	30 3/4" (781)	32 3/4" (832)	38 3/4" (984)
ROUGH OPENING	20 3/4" (527)	24 3/4" (629)	28 3/4" (730)	30 3/4" (781)	36 3/4" (933)
FRAME SIZE	20" (508)	24" (609)	28" (711)	30" (762)	36" (914)
DAYLIGHT OPENING	15 1/2" (394)	19 1/2" (495)	23 1/2" (597)	25 1/2" (648)	31 1/2" (800)
56 3/4" (1441) 58 3/4" (1391) 54" (1372) 25 1/2" (648) 19 1/2" (495)					
62 3/4" (1594) 60 3/4" (1543) 60" (1524) 31 1/2" (800) 19 1/2" (495)					
66 3/4" (1695) 64 3/4" (1645) 64" (1626) 35 1/2" (902) 19 1/2" (495)					
70 3/4" (1797) 68 3/4" (1746) 68" (1727) 39 1/2" (1003) 19 1/2" (495)					
74 3/4" (1899) 72 3/4" (1848) 72" (1829) 43 1/2" (1105) 19 1/2" (495)					
80 3/4" (2051) 78 3/4" (2000) 78" (1981) 49 1/2" (1257) 19 1/2" (495)					
82 3/4" (2102) 80 3/4" (2051) 80" (2032) 51 1/2" (1308) 19 1/2" (495)					
86 3/4" (2203) 84 3/4" (2153) 84" (2134) 55 1/2" (1410) 19 1/2" (495)					

ELEVATION SYMBOL LEGEND:
VALUES IN () ARE IN MILLIMETER CONVERSIONS.

E UNIT MEETS EGRESS REQUIREMENTS FOR IRC CODE. STATE AND LOCAL EGRESS CODES MAY DIFFER. ALWAYS REFER TO LOCAL BUILDING CODES FOR COMPLETE REQUIREMENTS. CHECK WITH LOCAL OFFICIALS TO ENSURE COMPLIANCE BEFORE INSTALLING THE UNIT.

SCALE: 1/8" = 1'

**1-WIDE UNITS
WITH 24" TRANSOM**

UNIT SIZE	22 3/4" (578)	26 3/4" (680)	30 3/4" (781)	32 3/4" (832)	38 3/4" (984)
ROUGH OPENING	20 3/4" (527)	24 3/4" (629)	28 3/4" (730)	30 3/4" (781)	36 3/4" (933)
FRAME SIZE	20" (508)	24" (609)	28" (711)	30" (762)	36" (914)
DAYLIGHT OPENING	15 1/2" (394)	19 1/2" (495)	23 1/2" (597)	25 1/2" (648)	31 1/2" (800)

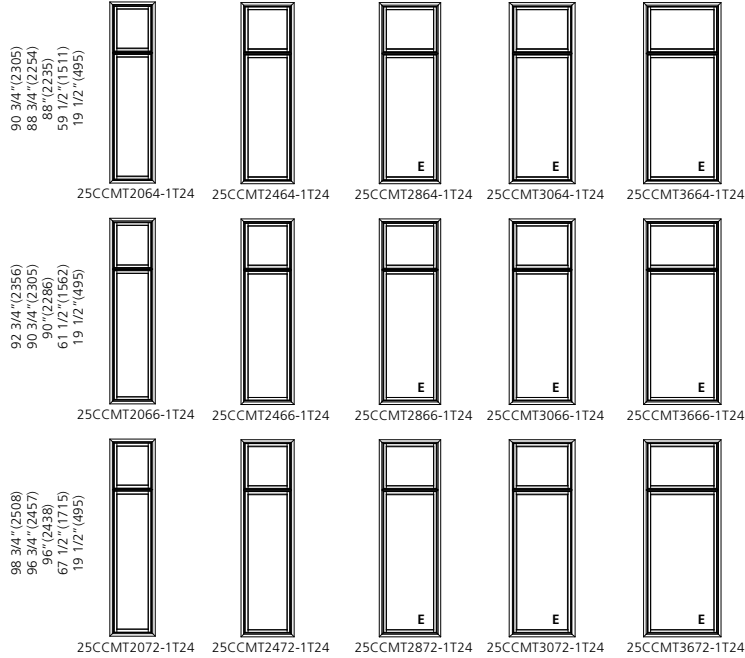

ELEVATION SYMBOL LEGEND:
VALUES IN () ARE IN MILLIMETER CONVERSIONS.

E UNIT MEETS EGRESS REQUIREMENTS FOR IRC CODE. STATE AND LOCAL EGRESS CODES MAY DIFFER. ALWAYS REFER TO LOCAL BUILDING CODES FOR COMPLETE REQUIREMENTS. CHECK WITH LOCAL OFFICIALS TO ENSURE COMPLIANCE BEFORE INSTALLING THE UNIT.

SCALE: 1/8" = 1'

1-WIDE UNITS - NOMINAL WITH 24" TRANSOM

UNIT SIZE ROUGH OPENING FRAME SIZE DAYLIGHT OPENING	26" (660) 24" (610) 23 1/4" (591) 18 3/4" (476)	32" (813) 30" (762) 29 1/4" (743) 24 3/4" (629)	38" (965) 36" (914) 35 1/4" (895) 30 3/4" (781)
55 1/4" (1403) 53 1/4" (1353) 52 1/2" (1334) 24 3/4" (629) 18 3/4" (476)			
61 1/4" (1556) 59 1/4" (1505) 58 1/2" (1486) 30 3/4" (781) 18 3/4" (476)			
67 1/4" (1708) 65 1/4" (1657) 64 1/2" (1638) 36 3/4" (933) 18 3/4" (476)			
73 1/4" (1861) 71 1/4" (1810) 70 1/2" (1791) 42 3/4" (1086) 18 3/4" (476)			
79 1/4" (2013) 77 1/4" (1962) 76 1/2" (1943) 48 3/4" (1238) 18 3/4" (476)			
85 1/4" (2165) 83 1/4" (2115) 82 1/2" (2096) 54 3/4" (1391) 18 3/4" (476)			
91 1/4" (2318) 89 1/4" (2267) 88 1/2" (2248) 60 3/4" (1543) 18 3/4" (476)			
97 1/4" (2470) 95 1/4" (2419) 94 1/2" (2400) 66 3/4" (1695) 18 3/4" (476)			

ELEVATION SYMBOL LEGEND:
VALUES IN () ARE IN MILLIMETER CONVERSIONS.

E UNIT MEETS EGRESS REQUIREMENTS FOR IRC CODE. STATE AND LOCAL EGRESS CODES MAY DIFFER. ALWAYS REFER TO LOCAL BUILDING CODES FOR COMPLETE REQUIREMENTS. CHECK WITH LOCAL OFFICIALS TO ENSURE COMPLIANCE BEFORE INSTALLING THE UNIT.

SCALE: 1/8" = 1'

1-WIDE UNITS WITH HALF ROUND TRANSM

UNIT SIZE
ROUGH OPENING
FRAME SIZE
DAYLIGHT OPENING

26 3/4" (680)
24 3/4" (629)
24" (609)
19 1/2" (495)[2]

44 3/4" (1137)
42 3/4" (1086)
42" (1067)
25 1/2" (648)
7 1/2" (191)

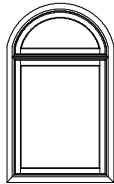

25CCMT2430-1HR

50 3/4" (1289)
48 3/4" (1238)
48" (1219)
31 1/2" (800)
7 1/2" (191)

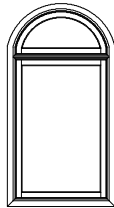

25CCMT2436-1HR

54 3/4" (1391)
52 3/4" (1340)
52" (1321)
35 1/2" (902)
7 1/2" (191)

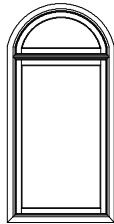

25CCMT2440-1HR

62 3/4" (1594)
60 3/4" (1543)
60" (1524)
43 1/2" (1105)
7 1/2" (191)

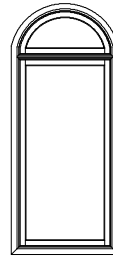

25CCMT2448-1HR

68 3/4" (1746)
66 3/4" (1696)
66" (1677)
49 1/2" (1257)
7 1/2" (191)

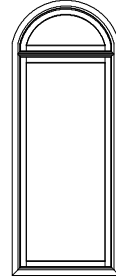

25CCMT2454-1HR

UNIT SIZE
ROUGH OPENING
FRAME SIZE
DAYLIGHT OPENING

26 3/4" (680)
24 3/4" (629)
24" (609)
19 1/2" (495)[2]

70 3/4" (1797)
68 3/4" (1746)
68" (1727)
51 1/2" (1308)
7 1/2" (191)

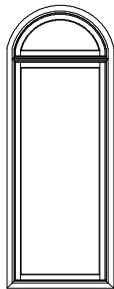

25CCMT2456-1HR

74 3/4" (1899)
72 3/4" (1848)
72" (1829)
55 1/2" (1410)
7 1/2" (191)

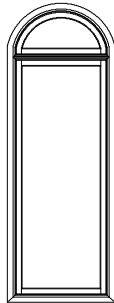

25CCMT2460-1HR

78 3/4" (2000)
76 3/4" (1949)
76" (1930)
59 1/2" (1511)
7 1/2" (191)

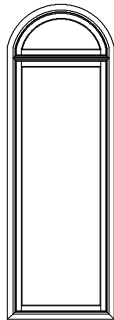

25CCMT2464-1HR

80 3/4" (2051)
78 3/4" (2000)
78" (1981)
61 1/2" (1562)
7 1/2" (191)

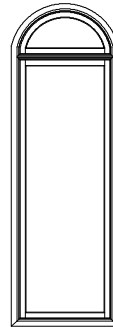

25CCMT2466-1HR

86 3/4" (2203)
84 3/4" (2153)
84" (2134)
67 1/2" (1715)
7 1/2" (191)

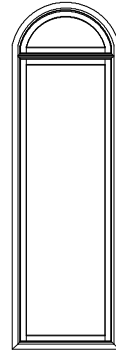

25CCMT2472-1HR

UNIT SIZE
ROUGH OPENING
FRAME SIZE
DAYLIGHT OPENING

30 3/4" (781)
28 3/4" (730)
28" (711)
23 1/2" (597)[2]

46 3/4" (1187)
44 3/4" (1137)
44" (1118)
25 1/2" (648)
9 1/2" (241)

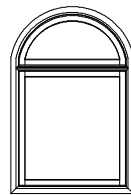

25CCMT2830-1HR

52 3/4" (1340)
50 3/4" (1289)
50" (1270)
31 1/2" (800)
9 1/2" (241)

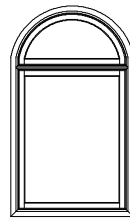

25CCMT2836-1HR

56 3/4" (1441)
54 3/4" (1391)
54" (1372)
35 1/2" (902)
9 1/2" (241)

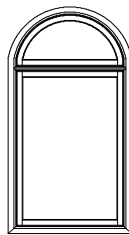

25CCMT2840-1HR

60 3/4" (1543)
58 3/4" (1492)
58" (1473)
39 1/2" (1003)
9 1/2" (241)

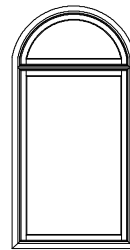

25CCMT2844-1HR

30 3/4" (781)
28 3/4" (730)
28" (711)
23 1/2" (597)[2]

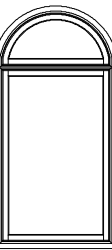

25CCMT2848-1HR

ELEVATION SYMBOL LEGEND:
VALUES IN () ARE IN MILLIMETER CONVERSIONS.
VALUES IN [] ARE NUMBER OF DAYLIGHT OPENINGS PER UNIT.

SCALE: 1/4" = 1'

**1-WIDE UNITS - NOMINAL
WITH HALF ROUND TRANSM**

UNIT SIZE ROUGH OPENING FRAME SIZE DAYLIGHT OPENING	26"(660) 24"(610) 23 1/4"(591) 18 3/4"(476)
43 5/8"(1108) 41 5/8"(1057) 40 7/8"(1038) 39 3/4"(1009) 7 1/8"(181)	
25CCMT2430N-1HR	
49 5/8"(1260) 47 5/8"(1210) 46 7/8"(1191) 39 3/4"(1009) 7 1/8"(181)	
25CCMT2436N-1HR	
55 5/8"(1413) 53 5/8"(1363) 52 7/8"(1343) 36 3/4"(933) 7 1/8"(181)	
25CCMT2442N-1HR	
61 5/8"(1565) 59 5/8"(1514) 58 7/8"(1495) 42 3/4"(1086) 7 1/8"(181)	
25CCMT2448N-1HR	
67 5/8"(1718) 65 5/8"(1667) 64 7/8"(1648) 48 3/4"(1238) 7 1/8"(181)	
25CCMT2454N-1HR	
73 5/8"(1870) 71 5/8"(1819) 70 7/8"(1800) 54 3/4"(1391) 7 1/8"(181)	
25CCMT2460N-1HR	
79 5/8"(2022) 77 5/8"(1972) 76 7/8"(1953) 60 3/4"(1543) 7 1/8"(181)	
25CCMT2466N-1HR	
85 5/8"(2175) 83 5/8"(2124) 82 7/8"(2105) 66 3/4"(1695) 7 1/8"(181)	
25CCMT2472N-1HR	

UNIT SIZE ROUGH OPENING FRAME SIZE DAYLIGHT OPENING	32"(813) 30"(762) 29 1/4"(743) 24 3/4"(629)
46 5/8"(1184) 44 5/8"(1133) 43 7/8"(1114) 24 3/4"(629) 10 1/8"(257)	
25CCMT3030N-1HR	
52 5/8"(1337) 50 5/8"(1286) 49 7/8"(1267) 30 3/4"(781) 10 1/8"(257)	
25CCMT3036N-1HR	
58 5/8"(1489) 56 5/8"(1438) 55 7/8"(1419) 36 3/4"(933) 10 1/8"(257)	
25CCMT3042N-1HR	
64 5/8"(1641) 62 5/8"(1591) 61 7/8"(1572) 42 3/4"(1086) 10 1/8"(257)	
25CCMT3048N-1HR	
70 5/8"(1794) 68 5/8"(1743) 67 7/8"(1724) 48 3/4"(1238) 10 1/8"(257)	
25CCMT3054N-1HR	
76 5/8"(1946) 74 5/8"(1895) 73 7/8"(1876) 54 3/4"(1391) 10 1/8"(257)	
25CCMT3060N-1HR	
82 5/8"(2099) 80 5/8"(2048) 79 7/8"(2029) 60 3/4"(1543) 10 1/8"(257)	
25CCMT3066N-1HR	
88 5/8"(2251) 86 5/8"(2200) 85 7/8"(2181) 66 3/4"(1695) 10 1/8"(257)	
25CCMT3072N-1HR	

UNIT SIZE ROUGH OPENING FRAME SIZE DAYLIGHT OPENING	38"(965) 36"(914) 35 1/4"(895) 30 3/4"(781)
49 5/8"(1260) 47 5/8"(1210) 46 7/8"(1191) 24 3/4"(629) 13 1/8"(333)	
25CCMT3630N-1HR	
55 5/8"(1413) 53 5/8"(1362) 52 7/8"(1343) 30 3/4"(781) 13 1/8"(333)	
25CCMT3636N-1HR	
61 5/8"(1565) 59 5/8"(1514) 58 7/8"(1495) 36 3/4"(933) 13 1/8"(333)	
25CCMT3642N-1HR	
67 5/8"(1718) 65 5/8"(1667) 64 7/8"(1648) 42 3/4"(1086) 13 1/8"(333)	
25CCMT3648N-1HR	
73 5/8"(1870) 71 5/8"(1819) 70 7/8"(1800) 48 3/4"(1238) 13 1/8"(333)	
25CCMT3654N-1HR	
79 5/8"(2022) 77 5/8"(1972) 76 7/8"(1953) 54 3/4"(1391) 13 1/8"(333)	
25CCMT3660N-1HR	
85 5/8"(2175) 83 5/8"(2124) 82 7/8"(2105) 60 3/4"(1543) 13 1/8"(333)	
25CCMT3666N-1HR	
91 5/8"(2327) 89 5/8"(2276) 88 7/8"(2257) 66 3/4"(1695) 13 1/8"(333)	
25CCMT3672N-1HR	

ELEVATION SYMBOL LEGEND:
VALUES IN () ARE IN MILLIMETER CONVERSIONS.

E UNIT MEETS EGRESS REQUIREMENTS FOR IRC CODE. STATE AND LOCAL EGRESS CODES MAY DIFFER. ALWAYS REFER TO LOCAL BUILDING CODES FOR COMPLETE REQUIREMENTS. CHECK WITH LOCAL OFFICIALS TO ENSURE COMPLIANCE BEFORE INSTALLING THE UNIT.

SCALE: 1/8" = 1'

2-WIDE UNITS

UNIT SIZE	42 3/4" (1086)	50 3/4" (1289)	58 3/4" (1492)	62 3/4" (1594)	74 3/4" (1899)
ROUGH OPENING	40 3/4" (1035)	48 3/4" (1238)	56 3/4" (1442)	60 3/4" (1543)	72 3/4" (1848)
FRAME SIZE	40" (1016)	48" (1219)	56" (1422)	60" (1524)	72" (1829)
DAYLIGHT OPENING	15 1/2" (394)[2]	19 1/2" (495)[4]	23 1/2" (597)[4]	25 1/2" (648)[4]	31 1/2" (800)[4]
30 3/4" (832) 30 3/4" (831) 30" (762) 25 1/2" (648)					
38 3/4" (984) 36 3/4" (934) 35" (891) 31 1/2" (800)					
42 3/4" (1086) 40 3/4" (1035) 40" (1016) 35 1/2" (902)					
50 3/4" (1289) 48 3/4" (1238) 48" (1219) 43 1/2" (1105)					
56 3/4" (1442) 54 3/4" (1391) 54" (1372) 49 1/2" (1257)					
58 3/4" (1492) 56 3/4" (1442) 56" (1422) 51 1/2" (1308)					
62 3/4" (1594) 60 3/4" (1543) 60" (1524) 55 1/2" (1410)					
66 3/4" (1696) 64 3/4" (1645) 64" (1626) 59 1/2" (1511)					
68 3/4" (1746) 66 3/4" (1696) 66" (1676) 61 1/2" (1562)					
74 3/4" (1899) 72 3/4" (1848) 72" (1829) 67 1/2" (1715)					

ELEVATION SYMBOL LEGEND:

VALUES IN () ARE IN MILLIMETER CONVERSIONS.

VALUES IN [] ARE NUMBER OF DAYLIGHT OPENINGS PER UNIT.

E UNIT MEETS EGRESS REQUIREMENTS FOR IRC CODE. STATE AND LOCAL EGRESS CODES MAY DIFFER. ALWAYS REFER TO LOCAL BUILDING CODES FOR COMPLETE REQUIREMENTS. CHECK WITH LOCAL OFFICIALS TO ENSURE COMPLIANCE BEFORE INSTALLING THE UNIT.

SCALE: 1/8" = 1'

2-WIDE UNITS - NOMINAL

UNIT SIZE	49 1/4" (1251)	61 1/4" (1556)	65 1/4" (1657)	73 1/4" (1861)
ROUGH OPENING	47 1/4" (1200)	59 1/4" (1505)	63 1/4" (1607)	71 1/4" (1810)
FRAME SIZE	46 1/2" (1181)	58 1/2" (1486)	62 1/2" (1588)	70 1/2" (1791)
DAYLIGHT OPENING	18 3/4" (476)[2]	24 3/4" (629)[2]	26 3/4" (679)[2]	30 3/4" (781)[2]
26" (660) 27" (690) 28" (713) 29" (737) 30" (762)				
32" (813) 33" (837) 34" (862) 35" (887) 36" (912)				
38" (965) 39" (990) 40" (1015) 41" (1040) 42" (1065)				
44" (1118) 45" (1143) 46" (1168) 47" (1193) 48" (1218)				
50" (1270) 51" (1295) 52" (1320) 53" (1345) 54" (1370)				
55" (1402) 56" (1427) 57" (1452) 58" (1477) 59" (1502)				
62" (1575) 63" (1600) 64" (1625) 65" (1650) 66" (1675)				
68" (1727) 69" (1752) 70" (1777) 71" (1802) 72" (1827)				
74" (1880) 75" (1905) 76" (1930) 77" (1955) 78" (1980)				

ELEVATION SYMBOL LEGEND:

VALUES IN () ARE IN MILLIMETER CONVERSIONS.

VALUES IN [] ARE NUMBER OF DAYLIGHT OPENINGS PER UNIT.

E UNIT MEETS EGRESS REQUIREMENTS FOR IRC CODE. STATE AND LOCAL EGRESS CODES MAY DIFFER. ALWAYS REFER TO LOCAL BUILDING CODES FOR COMPLETE REQUIREMENTS. CHECK WITH LOCAL OFFICIALS TO ENSURE COMPLIANCE BEFORE INSTALLING THE UNIT.

SCALE: 1/8" = 1'

**2-WIDE UNITS
WITH 15" TRANSOM**

UNIT SIZE	42 3/4"(1086)	50 3/4"(1289)	58 3/4"(1492)	62 3/4"(1594)	74 3/4"(1899)
ROUGH OPENING	40 3/4"(1035)	48 3/4"(1238)	56 3/4"(1441)	60 3/4"(1543)	72 3/4"(1848)
FRAME SIZE	40"(1016)	48"(1219)	56"(1422)	60"(1524)	72"(1829)
DAYLIGHT OPENING	15 1/2"(394)[2]	19 1/2"(495)[2]	23 1/2"(597)[2]	25 1/2"(648)[2]	31 1/2"(800)[2]
47 3/4"(1213) 45 3/4"(1162) 45"(1143) 25 1/2"(648) 10 1/2"(267)					
53 3/4"(1365) 51 3/4"(1314) 51"(1295) 31 1/2"(800) 10 1/2"(267)					
57 3/4"(1467) 55 3/4"(1416) 55"(1397) 35 1/2"(902) 10 1/2"(267)					
65 3/4"(1670) 63 3/4"(1619) 63"(1600) 43 1/2"(1105) 10 1/2"(267)					
71 3/4"(1822) 69 3/4"(1772) 69"(1753) 49 1/2"(1257) 10 1/2"(267)					
73 3/4"(1873) 71 3/4"(1822) 71"(1803) 51 1/2"(1308) 10 1/2"(267)					
77 3/4"(1975) 75 3/4"(1924) 75"(1905) 55 1/2"(1410) 10 1/2"(267)					
81 3/4"(2076) 79 3/4"(2026) 79"(2007) 59 1/2"(1511) 10 1/2"(267)					

ELEVATION SYMBOL LEGEND:

VALUES IN () ARE IN MILLIMETER CONVERSIONS.

VALUES IN [] ARE NUMBER OF DAYLIGHT OPENINGS PER UNIT.

E UNIT MEETS EGRESS REQUIREMENTS FOR IRC CODE. STATE AND LOCAL EGRESS CODES MAY DIFFER. ALWAYS REFER TO LOCAL BUILDING CODES FOR COMPLETE REQUIREMENTS. CHECK WITH LOCAL OFFICIALS TO ENSURE COMPLIANCE BEFORE INSTALLING THE UNIT.

SCALE: 1/8" = 1'

**2-WIDE UNITS
WITH 15" TRANSOM**

UNIT SIZE	42 3/4"(1086)	50 3/4"(1289)	58 3/4"(1492)	62 3/4"(1594)	74 3/4"(1899)
ROUGH OPENING	40 3/4"(1035)	48 3/4"(1238)	56 3/4"(1441)	60 3/4"(1543)	72 3/4"(1848)
FRAME SIZE	40"(1016)	48"(1219)	56"(1422)	60"(1524)	72"(1829)
DAYLIGHT OPENING	15 1/2"(394)[2]	19 1/2"(495)[2]	23 1/2"(597)[2]	25 1/2"(648)[2]	31 1/2"(800)[2]

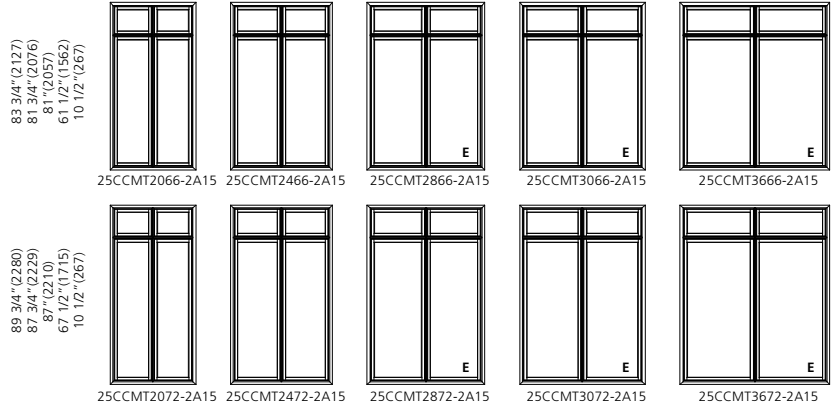

ELEVATION SYMBOL LEGEND:
 VALUES IN () ARE IN MILLIMETER CONVERSIONS.
 VALUES IN [] ARE NUMBER OF DAYLIGHT OPENINGS PER UNIT.
E UNIT MEETS EGRESS REQUIREMENTS FOR IRC CODE. STATE AND LOCAL EGRESS CODES MAY DIFFER. ALWAYS REFER TO LOCAL BUILDING CODES FOR COMPLETE REQUIREMENTS.
 CHECK WITH LOCAL OFFICIALS TO ENSURE COMPLIANCE BEFORE INSTALLING THE UNIT.

SCALE: 1/8" = 1'

2-WIDE UNITS - NOMINAL WITH 18" TRANSOM

UNIT SIZE ROUGH OPENING FRAME SIZE DAYLIGHT OPENING	49 1/4" (1251) 47 1/4" (1200) 46 1/2" (1181) 18 3/4" (476)[2]	61 1/4" (1556) 59 1/4" (1505) 58 1/2" (1486) 24 3/4" (629)[2]	73 1/4" (1861) 71 1/4" (1810) 70 1/2" (1791) 30 3/4" (781)[2]
49 1/4" (1251) 47 1/4" (1200) 46 1/2" (1181) 24 3/4" (629) 12 3/4" (324)			
	25CCMT2430N-2A18	25CCMT3030N-2A18	25CCMT3630N-2A18
55 1/4" (1403) 53 1/4" (1353) 52 1/2" (1334) 30 3/4" (781) 12 3/4" (324)			
	25CCMT2436N-2A18	25CCMT3036N-2A18	25CCMT3636N-2A18
61 1/4" (1556) 59 1/4" (1505) 58 1/2" (1486) 36 3/4" (933) 12 3/4" (324)			
	25CCMT2442N-2A18	25CCMT3042N-2A18	25CCMT3642N-2A18
67 1/4" (1708) 65 1/4" (1657) 64 1/2" (1638) 42 3/4" (1086) 12 3/4" (324)			
	25CCMT2448N-2A18	25CCMT3048N-2A18	25CCMT3648N-2A18
73 1/4" (1861) 71 1/4" (1810) 70 1/2" (1791) 48 3/4" (1238) 12 3/4" (324)			
	25CCMT2454N-2A18	25CCMT3054N-2A18	25CCMT3654N-2A18
79 1/4" (2013) 77 1/4" (1962) 76 1/2" (1943) 54 3/4" (1391) 12 3/4" (324)			
	25CCMT2460N-2A18	25CCMT3060N-2A18	25CCMT3660N-2A18
85 1/4" (2165) 83 1/4" (2115) 82 1/2" (2093) 60 3/4" (1543) 12 3/4" (324)			
	25CCMT2466N-2A18	25CCMT3066N-2A18	25CCMT3666N-2A18
91 1/4" (2292) 89 1/4" (2267) 88 1/2" (2248) 66 3/4" (1695) 12 3/4" (324)			
	25CCMT2472N-2A18	25CCMT3072N-2A18	25CCMT3672N-2A18

ELEVATION SYMBOL LEGEND:

VALUES IN () ARE IN MILLIMETER CONVERSIONS.

VALUES IN [] ARE NUMBER OF DAYLIGHT OPENINGS PER UNIT.

E UNIT MEETS EGRESS REQUIREMENTS FOR IRC CODE. STATE AND LOCAL EGRESS CODES MAY DIFFER. ALWAYS REFER TO LOCAL BUILDING CODES FOR COMPLETE REQUIREMENTS. CHECK WITH LOCAL OFFICIALS TO ENSURE COMPLIANCE BEFORE INSTALLING THE UNIT.

SCALE: 1/8" = 1'

2-WIDE UNITS
WITH 24" TRANSOM

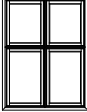
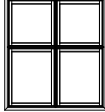
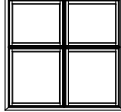
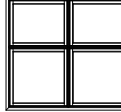
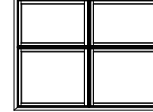
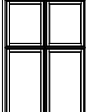
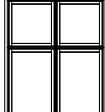
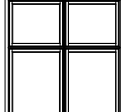
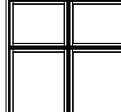
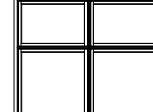
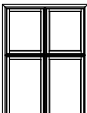
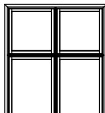
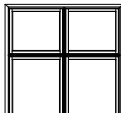
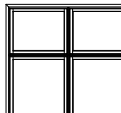
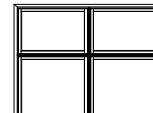
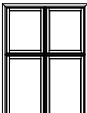
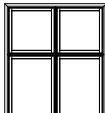
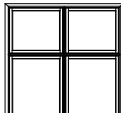
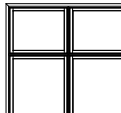
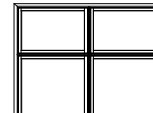
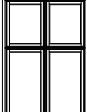
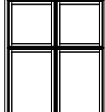
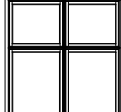
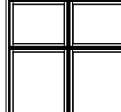
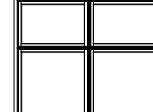
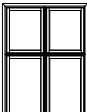
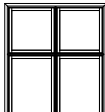
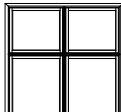
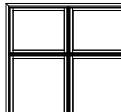
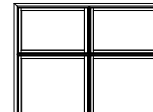
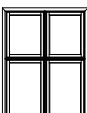
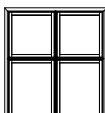
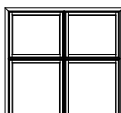
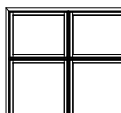
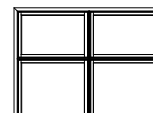
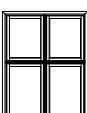
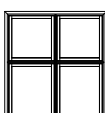
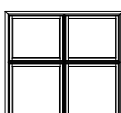
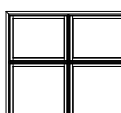
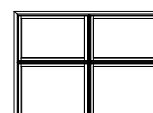
UNIT SIZE	42 3/4"(1086)	50 3/4"(1289)	58 3/4"(1492)	62 3/4"(1594)	74 3/4"(1899)
ROUGH OPENING	40 3/4"(1035)	48 3/4"(1238)	56 3/4"(1441)	60 3/4"(1543)	72 3/4"(1848)
FRAME SIZE	40"(1016)	48"(1219)	56"(1422)	60"(1524)	72"(1829)
DAYLIGHT OPENING	15 1/2"(394)[2]	19 1/2"(495)[2]	23 1/2"(597)[2]	25 1/2"(648)[2]	31 1/2"(800)[2]
56 3/4"(1441) 54 3/4"(1391) 54"(1372) 25 1/2"(648) 19 1/2"(495)	 25CCMT2030-2A24	 25CCMT2430-2A24	 25CCMT2830-2A24	 25CCMT3030-2A24	 25CCMT3630-2A24
62 3/4"(1594) 60 3/4"(1543) 60"(1524) 31 1/2"(800) 19 1/2"(495)	 25CCMT2036-2A24	 25CCMT2436-2A24	 25CCMT2836-2A24	 25CCMT3036-2A24	 25CCMT3636-2A24
66 3/4"(1695) 64 3/4"(1645) 64"(1626) 35 1/2"(902) 19 1/2"(495)	 25CCMT2040-2A24	 25CCMT2440-2A24	 25CCMT2840-2A24	 25CCMT3040-2A24	 25CCMT3640-2A24
74 3/4"(1899) 72 3/4"(1848) 72"(1829) 43 1/2"(1105) 19 1/2"(495)	 25CCMT2048-2A24	 25CCMT2448-2A24	 25CCMT2848-2A24	 25CCMT3048-2A24	 25CCMT3648-2A24
80 3/4"(2051) 78 3/4"(2000) 78"(1981) 49 1/2"(1257) 19 1/2"(495)	 25CCMT2054-2A24	 25CCMT2454-2A24	 25CCMT2854-2A24	 25CCMT3054-2A24	 25CCMT3654-2A24
82 3/4"(2102) 80 3/4"(2051) 80"(2032) 51 1/2"(1308) 19 1/2"(495)	 25CCMT2056-2A24	 25CCMT2456-2A24	 25CCMT2856-2A24	 25CCMT3056-2A24	 25CCMT3656-2A24
86 3/4"(2203) 84 3/4"(2153) 84"(2134) 55 1/2"(1410) 19 1/2"(495)	 25CCMT2060-2A24	 25CCMT2460-2A24	 25CCMT2860-2A24	 25CCMT3060-2A24	 25CCMT3660-2A24
90 3/4"(2305) 88 3/4"(2254) 88"(2235) 59 1/2"(1511) 19 1/2"(495)	 25CCMT2064-2A24	 25CCMT2464-2A24	 25CCMT2864-2A24	 25CCMT3064-2A24	 25CCMT3664-2A24

ELEVATION SYMBOL LEGEND:

VALUES IN () ARE IN MILLIMETER CONVERSIONS.

VALUES IN [] ARE NUMBER OF DAYLIGHT OPENINGS PER UNIT.

E UNIT MEETS EGRESS REQUIREMENTS FOR IRC CODE. STATE AND LOCAL EGRESS CODES MAY DIFFER. ALWAYS REFER TO LOCAL BUILDING CODES FOR COMPLETE REQUIREMENTS. CHECK WITH LOCAL OFFICIALS TO ENSURE COMPLIANCE BEFORE INSTALLING THE UNIT.

SCALE: 1/8" = 1'

**2-WIDE UNITS
WITH 24" TRANSOM**

UNIT SIZE	42 3/4" (1086)	50 3/4" (1289)	58 3/4" (1492)	62 3/4" (1594)	74 3/4" (1899)
ROUGH OPENING	40 3/4" (1035)	48 3/4" (1238)	56 3/4" (1441)	60 3/4" (1543)	72 3/4" (1848)
FRAME SIZE	40" (1016)	48" (1219)	56" (1422)	60" (1524)	72" (1829)
DAYLIGHT OPENING	15 1/2" (394)[2]	19 1/2" (495)[2]	23 1/2" (597)[2]	25 1/2" (648)[2]	31 1/2" (800)[2]

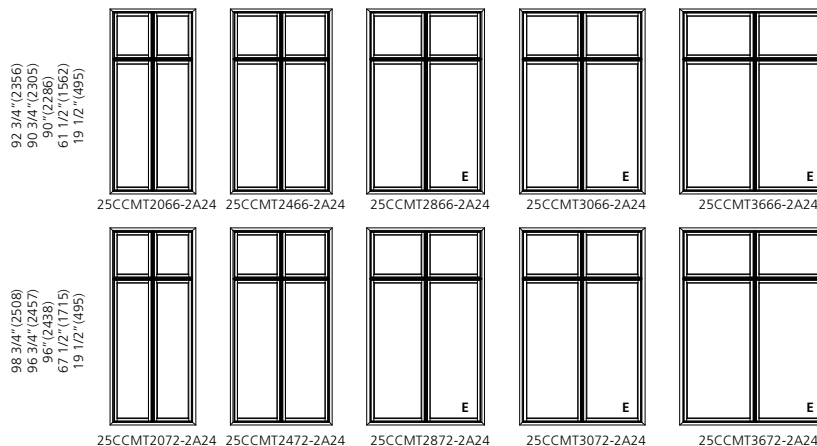

ELEVATION SYMBOL LEGEND:

VALUES IN () ARE IN MILLIMETER CONVERSIONS.

VALUES IN [] ARE NUMBER OF DAYLIGHT OPENINGS PER UNIT.

E UNIT MEETS EGRESS REQUIREMENTS FOR IRC CODE. STATE AND LOCAL EGRESS CODES MAY DIFFER. ALWAYS REFER TO LOCAL BUILDING CODES FOR COMPLETE REQUIREMENTS. CHECK WITH LOCAL OFFICIALS TO ENSURE COMPLIANCE BEFORE INSTALLING THE UNIT.

SCALE: 1/8" = 1'

2-WIDE UNITS - NOMINAL WITH 24" TRANSOM

UNIT SIZE ROUGH OPENING FRAME SIZE DAYLIGHT OPENING	49 1/4"(1251) 47 1/4"(1200) 46 1/2"(1181) 18 3/4"(476)[2]	61 1/4"(1556) 59 1/4"(1505) 58 1/2"(1486) 24 3/4"(629)[2]	73 1/4"(1861) 71 1/4"(1810) 70 1/2"(1791) 30 3/4"(781)[2]
55 1/4"(1403) 53 1/4"(1353) 52 1/2"(1334) 24 3/4"(629) 18 3/4"(476)			
61 1/4"(1556) 59 1/4"(1505) 58 1/2"(1486) 30 3/4"(781) 18 3/4"(476)			
67 1/4"(1708) 65 1/4"(1657) 64 1/2"(1638) 36 3/4"(933) 18 3/4"(476)			
73 1/4"(1861) 71 1/4"(1810) 70 1/2"(1791) 42 3/4"(1086) 18 3/4"(476)			
79 1/4"(2013) 77 1/4"(1962) 76 1/2"(1943) 48 3/4"(1238) 18 3/4"(476)			
85 1/4"(2165) 83 1/4"(2115) 82 1/2"(2063) 54 3/4"(1391) 18 3/4"(476)			
91 1/4"(2318) 89 1/4"(2267) 88 1/2"(2248) 60 3/4"(1543) 18 3/4"(476)			
97 1/4"(2470) 95 1/4"(2419) 94 1/2"(2400) 66 3/4"(1695) 18 3/4"(476)			

ELEVATION SYMBOL LEGEND:

VALUES IN () ARE IN MILLIMETER CONVERSIONS.

VALUES IN [] ARE NUMBER OF DAYLIGHT OPENINGS PER UNIT.

E UNIT MEETS EGRESS REQUIREMENTS FOR IRC CODE. STATE AND LOCAL EGRESS CODES MAY DIFFER. ALWAYS REFER TO LOCAL BUILDING CODES FOR COMPLETE REQUIREMENTS. CHECK WITH LOCAL OFFICIALS TO ENSURE COMPLIANCE BEFORE INSTALLING THE UNIT.

SCALE: 1/8" = 1'

3-WIDE UNITS

UNIT SIZE ROUGH OPENING FRAME SIZE DAYLIGHT OPENING	62 3/4" (1594) 60 3/4" (1543) 60" (1524) 15 1/2" (394)[3]	74 3/4" (1899) 72 3/4" (1848) 72" (1829) 19 1/2" (495)[3]	86 3/4" (2203) 84 3/4" (2153) 84" (2134) 23 1/2" (597)[3]	92 3/4" (2356) 90 3/4" (2305) 90" (2286) 25 1/2" (648)[3]	110 3/4" (2813) 108 3/4" (2762) 108" (2743) 31 1/2" (800)[3]
32 3/4" (832) 30 3/4" (781) 30" (762) 25 1/2" (648)					
38 3/4" (984) 36 3/4" (934) 36" (914) 31 1/2" (800)					
42 3/4" (1086) 40 3/4" (1035) 40" (1016) 35 1/2" (902)					
50 3/4" (1289) 48 3/4" (1238) 48" (1219) 43 1/2" (1105)					
56 3/4" (1442) 54 3/4" (1391) 54" (1372) 49 1/2" (1257)					
58 3/4" (1492) 56 3/4" (1442) 56" (1422) 51 1/2" (1308)					
62 3/4" (1594) 60 3/4" (1543) 60" (1524) 55 1/2" (1410)					
66 3/4" (1696) 64 3/4" (1645) 64" (1626) 59 1/2" (1511)					
68 3/4" (1746) 66 3/4" (1696) 66" (1676) 61 1/2" (1562)					
74 3/4" (1899) 72 3/4" (1848) 72" (1829) 67 1/2" (1715)					

ELEVATION SYMBOL LEGEND:

VALUES IN () ARE IN MILLIMETER CONVERSIONS.

VALUES IN [] ARE NUMBER OF DAYLIGHT OPENINGS PER UNIT.

E UNIT MEETS EGRESS REQUIREMENTS FOR IRC CODE. STATE AND LOCAL EGRESS CODES MAY DIFFER. ALWAYS REFER TO LOCAL BUILDING CODES FOR COMPLETE REQUIREMENTS. CHECK WITH LOCAL OFFICIALS TO ENSURE COMPLIANCE BEFORE INSTALLING THE UNIT.

SCALE: 1/8" = 1'

3-WIDE UNITS - NOMINAL

UNIT SIZE	72 1/2" (1842)	90 1/2" (2299)	96 1/2" (2451)	108 1/2" (2756)
ROUGH OPENING	70 1/2" (1791)	88 1/2" (2248)	94 1/2" (2400)	106 1/2" (2705)
FRAME SIZE	69 3/4" (1772)	87 3/4" (2229)	93 3/4" (2381)	105 3/4" (2686)
DAYLIGHT OPENING	18 3/4" (476)[3]	24 3/4" (629)[3]	26 3/4" (679)[3]	30 3/4" (781)[3]
26" (660) 24" (610) 23 1/4" (591) 18 3/4" (476)				
32" (813) 30" (762) 29 1/4" (743) 24 3/4" (629)				
38" (965) 36" (914) 35 1/4" (895) 30 3/4" (781)				
44" (1118) 42" (1067) 41 1/4" (1048) 36 3/4" (933)				
50" (1270) 48" (1219) 47 1/4" (1200) 42 3/4" (1086)				
56" (1422) 54" (1372) 53 1/4" (1353) 48 3/4" (1238)				
62" (1575) 60" (1524) 59 1/4" (1505) 54 3/4" (1391)				
68" (1727) 66" (1676) 65 1/4" (1657) 60 3/4" (1543)				
74" (1880) 72" (1829) 71 1/4" (1810) 66 3/4" (1695)				

ELEVATION SYMBOL LEGEND:

VALUES IN () ARE IN MILLIMETER CONVERSIONS.

VALUES IN [] ARE NUMBER OF DAYLIGHT OPENINGS PER UNIT.

E UNIT MEETS EGRESS REQUIREMENTS FOR IRC CODE. STATE AND LOCAL EGRESS CODES MAY DIFFER. ALWAYS REFER TO LOCAL BUILDING CODES FOR COMPLETE REQUIREMENTS. CHECK WITH LOCAL OFFICIALS TO ENSURE COMPLIANCE BEFORE INSTALLING THE UNIT.

SCALE: 1/8" = 1'

3-WIDE UNITS WITH 15" TRANSOM

UNIT SIZE ROUGH OPENING FRAME SIZE DAYLIGHT OPENING	62 3/4" (1594) 60 3/4" (1543) 60" (1524) 15 1/2" (394)[3]	74 3/4" (1899) 72 3/4" (1848) 72" (1829) 19 1/2" (495)[3]	86 3/4" (2203) 84 3/4" (2153) 84" (2134) 23 1/2" (597)[3]	92 3/4" (2356) 90 3/4" (2305) 90" (2286) 25 1/2" (648)[3]	110 3/4" (2813) 108 3/4" (2762) 108" (2743) 31 1/2" (800)[3]
47 3/4" (1213) 45 3/4" (1162) 45" (1143) 25 1/2" (648) 10 1/2" (267)					
53 3/4" (1365) 51 3/4" (1314) 51" (1295) 31 1/2" (800) 10 1/2" (267)					
57 3/4" (1467) 55 3/4" (1416) 55" (1397) 35 1/2" (902) 10 1/2" (267)					
65 3/4" (1670) 63 3/4" (1619) 63" (1600) 43 1/2" (1105) 10 1/2" (267)					
71 3/4" (1822) 69 3/4" (1772) 69" (1753) 49 1/2" (1257) 10 1/2" (267)					
73 3/4" (1873) 71 3/4" (1822) 71" (1803) 51 1/2" (1308) 10 1/2" (267)					
77 3/4" (1975) 75 3/4" (1924) 75" (1905) 55 1/2" (1410) 10 1/2" (267)					
81 3/4" (2076) 79 3/4" (2026) 79" (2007) 59 1/2" (1511) 10 1/2" (267)					

ELEVATION SYMBOL LEGEND:

VALUES IN () ARE IN MILLIMETER CONVERSIONS.

VALUES IN [] ARE NUMBER OF DAYLIGHT OPENINGS PER UNIT.

E UNIT MEETS EGRESS REQUIREMENTS FOR IRC CODE. STATE AND LOCAL EGRESS CODES MAY DIFFER. ALWAYS REFER TO LOCAL BUILDING CODES FOR COMPLETE REQUIREMENTS. CHECK WITH LOCAL OFFICIALS TO ENSURE COMPLIANCE BEFORE INSTALLING THE UNIT.

SCALE: 1/8" = 1'

**3-WIDE UNITS
WITH 15" TRANSOM**

UNIT SIZE	62 3/4"(1594)	74 3/4"(1899)	86 3/4"(2203)	92 3/4"(2356)	110 3/4"(2813)
ROUGH OPENING	60 3/4"(1543)	72 3/4"(1848)	84 3/4"(2153)	90 3/4"(2305)	108 3/4"(2762)
FRAME SIZE	60"(1524)	72"(1829)	84"(2134)	90"(2286)	108"(2743)
DAYLIGHT OPENING	15 1/2"(394)[3]	19 1/2"(495)[3]	23 1/2"(597)[3]	25 1/2"(648)[3]	31 1/2"(800)[3]

83 3/4"(2127)
81 3/4"(2076)
81"(2057)
61 1/2"(1562)
10 1/2"(267)

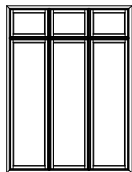

25CCMT2066-3A15

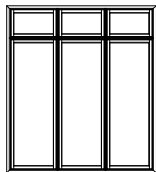

25CCMT2466-3A15

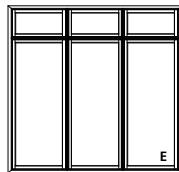

25CCMT2866-3A15

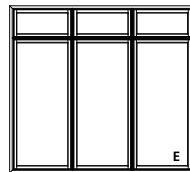

25CCMT3066-3A15

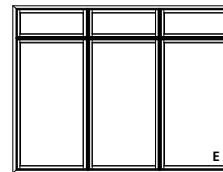

25CCMT3666-3A15

89 3/4"(2280)
87 3/4"(2229)
87"(2210)
67 1/2"(1715)
10 1/2"(267)

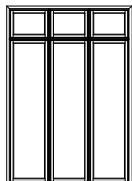

25CCMT2072-3A15

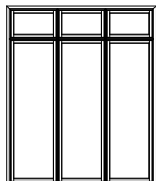

25CCMT2472-3A15

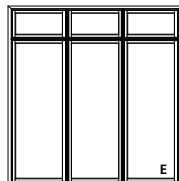

25CCMT2872-3A15

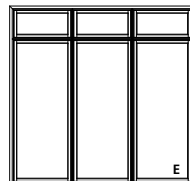

25CCMT3072-3A15

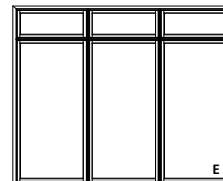

25CCMT3672-3A15

ELEVATION SYMBOL LEGEND:











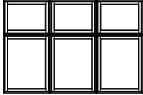

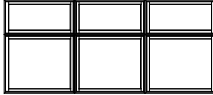











VALUES IN () ARE IN MILLIMETER CONVERSIONS.

VALUES IN [] ARE NUMBER OF DAYLIGHT OPENINGS PER UNIT.

E UNIT MEETS EGRESS REQUIREMENTS FOR IRC CODE. STATE AND LOCAL EGRESS CODES MAY DIFFER. ALWAYS REFER TO LOCAL BUILDING CODES FOR COMPLETE REQUIREMENTS. CHECK WITH LOCAL OFFICIALS TO ENSURE COMPLIANCE BEFORE INSTALLING THE UNIT.

SCALE: 1/8" = 1'

3-WIDE UNITS - NOMINAL
WITH 18" TRANSOM

UNIT SIZE ROUGH OPENING FRAME SIZE DAYLIGHT OPENING	72 1/2" (1842) 70 1/2" (1791) 69 3/4" (1772) 18 3/4" (476)[3]	90 1/2" (2299) 88 1/2" (2248) 87 3/4" (2229) 24 3/4" (629)[3]	108 1/2" (2756) 106 1/2" (2705) 105 3/4" (2686) 30 3/4" (781)[3]
49 1/4" (1251) 47 1/4" (1200) 46 1/2" (1181) 24 3/4" (629) 12 3/4" (324)	 25CCMT2430N-3A18	 25CCMT3030N-3A18	 25CCMT3630N-3A18
55 1/4" (1403) 53 1/4" (1353) 52 1/2" (1334) 30 3/4" (781) 12 3/4" (324)	 25CCMT2436N-3A18	 25CCMT3036N-3A18	 25CCMT3636N-3A18
61 1/4" (1556) 59 1/4" (1505) 58 1/2" (1486) 36 3/4" (933) 12 3/4" (324)	 25CCMT2442N-3A18	 25CCMT3042N-3A18	 25CCMT3642N-3A18
67 1/4" (1708) 65 1/4" (1657) 64 1/2" (1638) 42 3/4" (1086) 12 3/4" (324)	 25CCMT2448N-3A18	 25CCMT3048N-3A18	 25CCMT3648N-3A18
73 1/4" (1861) 71 1/4" (1810) 70 1/2" (1791) 48 3/4" (1238) 12 3/4" (324)	 25CCMT2454N-3A18	 25CCMT3054N-3A18	 25CCMT3654N-3A18
79 1/4" (2013) 77 1/4" (1962) 76 1/2" (1943) 54 3/4" (1391) 12 3/4" (324)	 25CCMT2460N-3A18	 25CCMT3060N-3A18	 25CCMT3660N-3A18
85 1/4" (2165) 83 1/4" (2115) 82 1/2" (2096) 60 3/4" (1543) 12 3/4" (324)	 25CCMT2466N-3A18	 25CCMT3066N-3A18	 25CCMT3666N-3A18
91 1/4" (2292) 89 1/4" (2267) 88 1/2" (2248) 66 3/4" (1695) 12 3/4" (324)	 25CCMT2472N-3A18	 25CCMT3072N-3A18	 25CCMT3672N-3A18

ELEVATION SYMBOL LEGEND:

VALUES IN () ARE IN MILLIMETER CONVERSIONS.

VALUES IN [] ARE NUMBER OF DAYLIGHT OPENINGS PER UNIT.

E UNIT MEETS EGRESS REQUIREMENTS FOR IRC CODE. STATE AND LOCAL EGRESS CODES MAY DIFFER. ALWAYS REFER TO LOCAL BUILDING CODES FOR COMPLETE REQUIREMENTS. CHECK WITH LOCAL OFFICIALS TO ENSURE COMPLIANCE BEFORE INSTALLING THE UNIT.

SCALE: 1/8" = 1'

3-WIDE UNITS WITH 24" TRANSOM

UNIT SIZE
ROUGH OPENING
FRAME SIZE
DAYLIGHT OPENING

62 3/4" (1594)
60 3/4" (1543)
60" (1524)
15 1/2" (394)[3]

74 3/4" (1899)
72 3/4" (1848)
72" (1829)
19 1/2" (495)[3]

86 3/4" (2203)
84 3/4" (2153)
84" (2134)
23 1/2" (597)[3]

92 3/4" (2356)
90 3/4" (2305)
90" (2286)
25 1/2" (648)[3]

110 3/4" (2813)
108 3/4" (2762)
108" (2743)
31 1/2" (800)[3]

56 3/4" (1441)
54 3/4" (1391)
54" (1372)
25 1/2" (648)
19 1/2" (495)

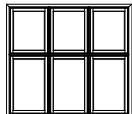

25CCMT2030-3A24

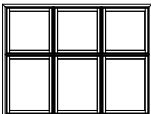

25CCMT2430-3A24

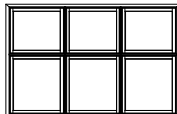

25CCMT2830-3A24

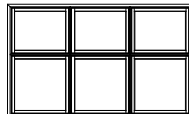

25CCMT3030-3A24

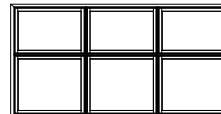

25CCMT3630-3A24

62 3/4" (1594)
60 3/4" (1543)
60" (1524)
31 1/2" (800)
19 1/2" (495)

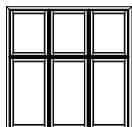

25CCMT2036-3A24

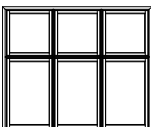

25CCMT2436-3A24

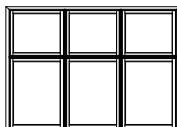

25CCMT2836-3A24

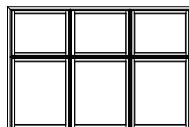

25CCMT3036-3A24

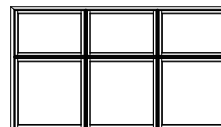

25CCMT3636-3A24

66 3/4" (1695)
64 3/4" (1645)
64" (1626)
35 1/2" (902)
19 1/2" (495)

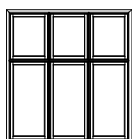

25CCMT2040-3A24

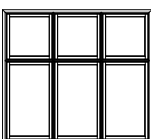

25CCMT2440-3A24

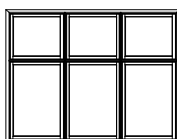

25CCMT2840-3A24

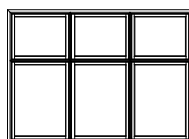

25CCMT3040-3A24

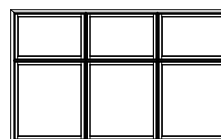

25CCMT3640-3A24

74 3/4" (1899)
72 3/4" (1848)
72" (1829)
43 1/2" (1105)
19 1/2" (495)

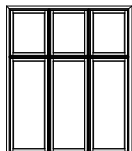

25CCMT2048-3A24

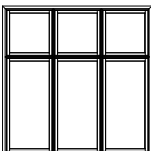

25CCMT2448-3A24

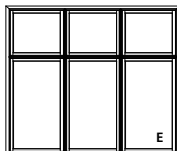

25CCMT2848-3A24

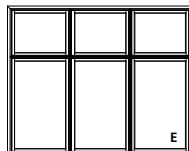

25CCMT3048-3A24

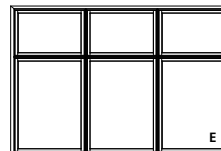

25CCMT3648-3A24

80 3/4" (2051)
78 3/4" (2000)
78" (1981)
49 1/2" (1257)
19 1/2" (495)

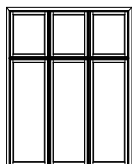

25CCMT2054-3A24

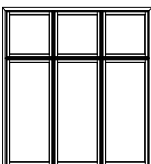

25CCMT2454-3A24

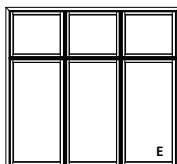

25CCMT2854-3A24

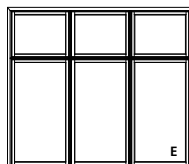

25CCMT3054-3A24

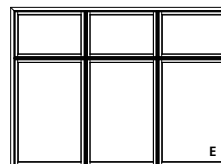

25CCMT3654-3A24

82 3/4" (2102)
80 3/4" (2051)
80" (2032)
51 1/2" (1308)
19 1/2" (495)

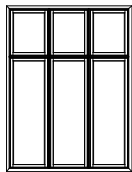

25CCMT2056-3A24

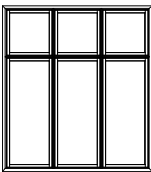

25CCMT2456-3A24

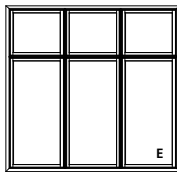

25CCMT2856-3A24

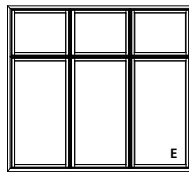

25CCMT3056-3A24

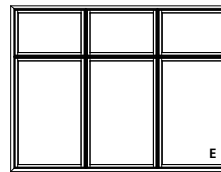

25CCMT3656-3A24

86 3/4" (2203)
84 3/4" (2153)
84" (2134)
55 1/2" (1410)
19 1/2" (495)

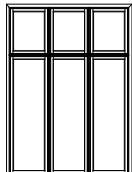

25CCMT2060-3A24

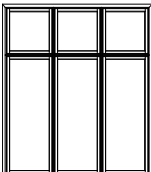

25CCMT2460-3A24

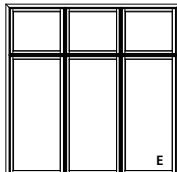

25CCMT2860-3A24

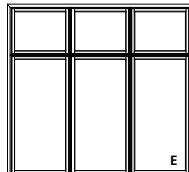

25CCMT3060-3A24

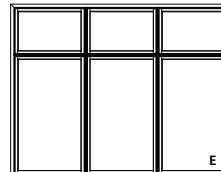

25CCMT3660-3A24

90 3/4" (2305)
88 3/4" (2254)
88" (2235)
59 1/2" (1511)
19 1/2" (495)



25CCMT2064-3A24

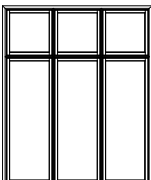

25CCMT2464-3A24

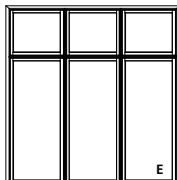

25CCMT2864-3A24

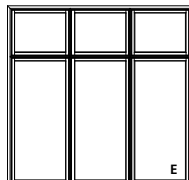

25CCMT3064-3A24

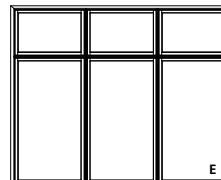

25CCMT3664-3A24

ELEVATION SYMBOL LEGEND:

VALUES IN () ARE IN MILLIMETER CONVERSIONS.

VALUES IN [] ARE NUMBER OF DAYLIGHT OPENINGS PER UNIT.

E UNIT MEETS EGRESS REQUIREMENTS FOR IRC CODE. STATE AND LOCAL EGRESS CODES MAY DIFFER. ALWAYS REFER TO LOCAL BUILDING CODES FOR COMPLETE REQUIREMENTS. CHECK WITH LOCAL OFFICIALS TO ENSURE COMPLIANCE BEFORE INSTALLING THE UNIT.

SCALE: 1/8" = 1'

**3-WIDE UNITS
WITH 24" TRANSOM**

UNIT SIZE
ROUGH OPENING
FRAME SIZE
DAYLIGHT OPENING

62 3/4" (1594)
60 3/4" (1543)
60" (1524)
15 1/2" (394)[3]

74 3/4" (1899)
72 3/4" (1848)
72" (1829)
19 1/2" (495)[3]

86 3/4" (2203)
84 3/4" (2153)
84" (2134)
23 1/2" (597)[3]

92 3/4" (2356)
90 3/4" (2305)
90" (2286)
25 1/2" (648)[3]

110 3/4" (2813)
108 3/4" (2762)
108" (2743)
31 1/2" (800)[3]

92 3/4" (2356)
90 3/4" (2305)
90" (2286)
61 1/2" (1562)
19 1/2" (495)



25CCMT2066-3A24

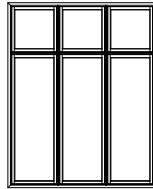

25CCMT2466-3A24

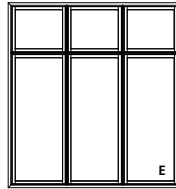

25CCMT2866-3A24

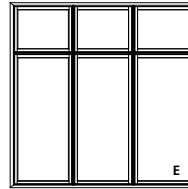

25CCMT3066-3A24

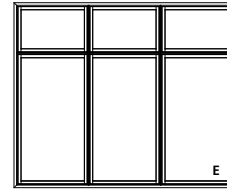

25CCMT3666-3A24

98 3/4" (2508)
96 3/4" (2457)
96" (2438)
67 1/2" (1715)
19 1/2" (495)

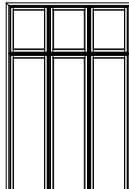

25CCMT2072-3A24

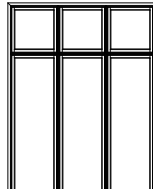

25CCMT2472-3A24

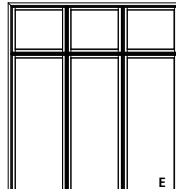

25CCMT2872-3A24

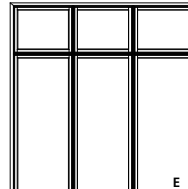

25CCMT3072-3A24

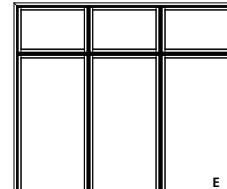

25CCMT3672-3A24

ELEVATION SYMBOL LEGEND:

VALUES IN () ARE IN MILLIMETER CONVERSIONS.

VALUES IN [] ARE NUMBER OF DAYLIGHT OPENINGS PER UNIT.

E UNIT MEETS EGRESS REQUIREMENTS FOR IRC CODE. STATE AND LOCAL EGRESS CODES MAY DIFFER. ALWAYS REFER TO LOCAL BUILDING CODES FOR COMPLETE REQUIREMENTS. CHECK WITH LOCAL OFFICIALS TO ENSURE COMPLIANCE BEFORE INSTALLING THE UNIT.

SCALE: 1/8" = 1'

3-WIDE UNITS - NOMINAL WITH 24" TRANSOM

UNIT SIZE
ROUGH OPENING
FRAME SIZE
DAYLIGHT OPENING

72 1/2" (1842)
70 1/2" (1791)
69 3/4" (1772)
18 3/4" (476) [3]

90 1/2" (2299)
88 1/2" (2248)
87 3/4" (2229)
24 3/4" (629) [3]

108 1/2" (2756)
106 1/2" (2705)
105 3/4" (2686)
30 3/4" (781) [3]

55 1/4" (1403)
53 1/4" (1353)
52 1/2" (1334)
24 3/4" (629)
18 3/4" (476)

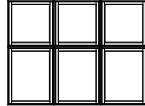

25CCMT2430N-3A24

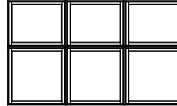

25CCMT3030N-3A24

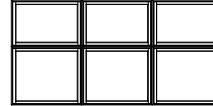

25CCMT3630N-3A24

61 1/4" (1556)
59 1/4" (1505)
58 1/2" (1486)
30 3/4" (781)
18 3/4" (476)

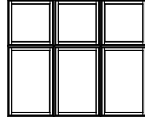

25CCMT2436N-3A24

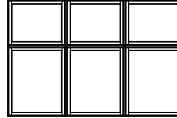

25CCMT3036N-3A24

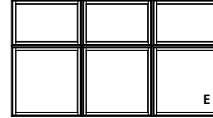

25CCMT3636N-3A24

67 1/4" (1708)
65 1/4" (1657)
64 1/2" (1638)
36 3/4" (933)
18 3/4" (476)

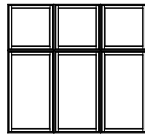

25CCMT2442N-3A24

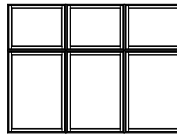

25CCMT3042N-3A24

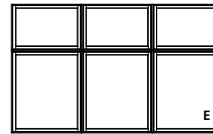

25CCMT3642N-3A24

73 1/4" (1861)
71 1/4" (1810)
70 1/2" (1791)
42 3/4" (1086)
18 3/4" (476)

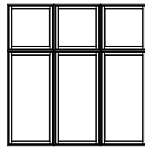

25CCMT2448N-3A24

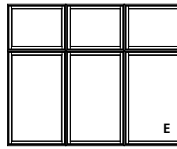

25CCMT3048N-3A24

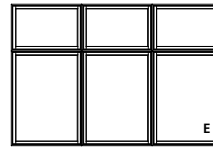

25CCMT3648N-3A24

79 1/4" (2013)
77 1/4" (1962)
76 1/2" (1943)
48 3/4" (1238)
18 3/4" (476)

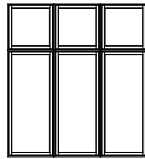

25CCMT2454N-3A24

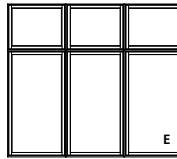

25CCMT3054N-3A24

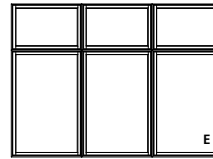

25CCMT3654N-3A24

85 1/4" (2165)
83 1/4" (2115)
82 1/2" (2096)
54 3/4" (1391)
18 3/4" (476)

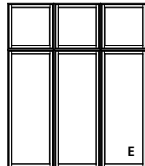

25CCMT2460N-3A24

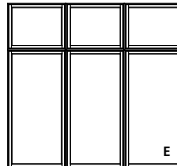

25CCMT3060N-3A24

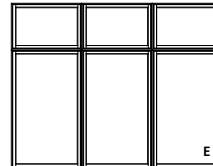

25CCMT3660N-3A24

91 1/4" (2318)
89 1/4" (2267)
88 1/2" (2248)
60 3/4" (1543)
18 3/4" (476)

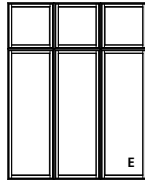

25CCMT2466N-3A24

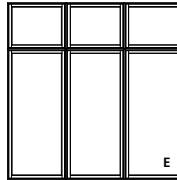

25CCMT3066N-3A24

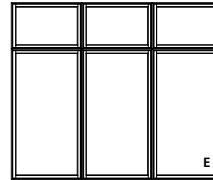

25CCMT3666N-3A24

97 1/4" (2470)
95 1/4" (2419)
94 1/2" (2400)
66 3/4" (1695)
18 3/4" (476)

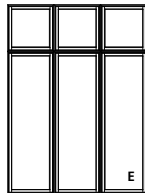

25CCMT2472N-3A24

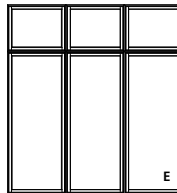

25CCMT3072N-3A24

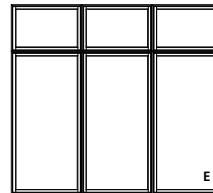

25CCMT3672N-3A24

ELEVATION SYMBOL LEGEND:

VALUES IN () ARE IN MILLIMETER CONVERSIONS.

VALUES IN [] ARE NUMBER OF DAYLIGHT OPENINGS PER UNIT.

E UNIT MEETS EGRESS REQUIREMENTS FOR IRC CODE. STATE AND LOCAL EGRESS CODES MAY DIFFER. ALWAYS REFER TO LOCAL BUILDING CODES FOR COMPLETE REQUIREMENTS. CHECK WITH LOCAL OFFICIALS TO ENSURE COMPLIANCE BEFORE INSTALLING THE UNIT.

SCALE: 1/8" = 1'

4-WIDE UNITS

UNIT SIZE ROUGH OPENING FRAME SIZE DAYLIGHT OPENING	82 3/4" (2102) 80 3/4" (2051) 80" (2032)	98 3/4" (2508) 96 3/4" (2457) 96" (2438)	114 3/4" (2915) 112 3/4" (2864) 112" (2849)	122 3/4" (3118) 120 3/4" (3067) 120" (3048)
32 3/4" (832) 30 3/4" (781) 30" (762) 25 1/2" (648)				
38 3/4" (984) 36 3/4" (934) 36" (914) 31 1/2" (800)				
42 3/4" (1086) 40 3/4" (1035) 40" (1016) 35 1/2" (902)				
50 3/4" (1289) 48 3/4" (1238) 48" (1219) 43 1/2" (1105)				
56 3/4" (1442) 54 3/4" (1391) 54" (1372) 49 1/2" (1257)				
58 3/4" (1492) 56 3/4" (1442) 56" (1422) 51 1/2" (1308)				
62 3/4" (1594) 60 3/4" (1543) 60" (1524) 55 1/2" (1410)				
66 3/4" (1696) 64 3/4" (1645) 64" (1626) 59 1/2" (1511)				
68 3/4" (1746) 66 3/4" (1696) 66" (1676) 61 1/2" (1562)				
74 3/4" (1899) 72 3/4" (1848) 72" (1829) 67 1/2" (1715)				

ELEVATION SYMBOL LEGEND:











VALUES IN () ARE IN MILLIMETER CONVERSIONS.

VALUES IN [] ARE NUMBER OF DAYLIGHT OPENINGS PER UNIT.

E UNIT MEETS EGRESS REQUIREMENTS FOR IRC CODE. STATE AND LOCAL EGRESS CODES MAY DIFFER. ALWAYS REFER TO LOCAL BUILDING CODES FOR COMPLETE REQUIREMENTS. CHECK WITH LOCAL OFFICIALS TO ENSURE COMPLIANCE BEFORE INSTALLING THE UNIT.

SCALE: 1/8" = 1'

4-WIDE UNITS

UNIT SIZE ROUGH OPENING FRAME SIZE DAYLIGHT OPENING	146 3/4" (3727) 144 3/4" (3677) 144" (3658) 31 1/2" (800)(4)
32 3/4" (832) 30 3/4" (781) 30" (762) 25 1/2" (648)	 25CCMT3630-4
38 3/4" (984) 36 3/4" (934) 36" (914) 31 1/2" (800)	 25CCMT3636-4
42 3/4" (1086) 40 3/4" (1035) 40" (1016) 35 1/2" (902)	 25CCMT3640-4
50 3/4" (1289) 48 3/4" (1238) 48" (1219) 43 1/2" (1105)	 25CCMT3648-4
56 3/4" (1442) 54 3/4" (1391) 54" (1372) 49 1/2" (1257)	 25CCMT3654-4
58 3/4" (1492) 56 3/4" (1442) 56" (1422) 51 1/2" (1308)	 25CCMT3656-4
62 3/4" (1594) 60 3/4" (1543) 60" (1524) 55 1/2" (1410)	 25CCMT3660-4
66 3/4" (1696) 64 3/4" (1645) 64" (1626) 59 1/2" (1511)	 25CCMT3664-4
68 3/4" (1746) 66 3/4" (1696) 66" (1676) 61 1/2" (1562)	 25CCMT3666-4
74 3/4" (1899) 72 3/4" (1848) 72" (1829) 67 1/2" (1715)	 25CCMT3672-4

ELEVATION SYMBOL LEGEND:
 VALUES IN () ARE IN MILLIMETER CONVERSIONS.
 VALUES IN [] ARE NUMBER OF DAYLIGHT OPENINGS PER UNIT.
 E UNIT MEETS EGRESS REQUIREMENTS FOR IRC CODE. STATE AND LOCAL EGRESS CODES MAY DIFFER. ALWAYS REFER TO LOCAL BUILDING CODES FOR COMPLETE REQUIREMENTS.
 CHECK WITH LOCAL OFFICIALS TO ENSURE COMPLIANCE BEFORE INSTALLING THE UNIT.

SCALE: 1/8" = 1'

5-WIDE UNITS

UNIT SIZE ROUGH OPENING FRAME SIZE DAYLIGHT OPENING	102 3/4"(2610) 100 3/4"(2559) 100"(2540) 15 1/2"(394)[5]	122 3/4"(3118) 120 3/4"(3067) 120"(3048) 19 1/2"(495)[5]	142 3/4"(3626) 140 3/4"(3575) 140"(3556) 23 1/2"(597)[5]	152 3/4"(3880) 150 3/4"(3829) 150"(3810) 25 1/2"(648)[5]
32 3/4"(832) 30 3/4"(781) 30"(762) 25 1/2"(648)				
38 3/4"(984) 36 3/4"(934) 36"(914) 31 1/2"(800)				
42 3/4"(1086) 40 3/4"(1035) 40"(1016) 35 1/2"(902)				
50 3/4"(1289) 48 3/4"(1238) 48"(1219) 43 1/2"(1105)				
56 3/4"(1442) 54 3/4"(1391) 54"(1372) 49 1/2"(1257)				
58 3/4"(1492) 56 3/4"(1442) 56"(1422) 51 1/2"(1308)				
62 3/4"(1594) 60 3/4"(1543) 60"(1524) 55 1/2"(1410)				
66 3/4"(1696) 64 3/4"(1645) 64"(1626) 59 1/2"(1511)				
68 3/4"(1746) 66 3/4"(1696) 66"(1676) 61 1/2"(1562)				
74 3/4"(1899) 72 3/4"(1848) 72"(1829) 67 1/2"(1715)				

ELEVATION SYMBOL LEGEND:
 VALUES IN () ARE IN MILLIMETER CONVERSIONS.
 VALUES IN [] ARE NUMBER OF DAYLIGHT OPENINGS PER UNIT.
E UNIT MEETS EGRESS REQUIREMENTS FOR IRC CODE. STATE AND LOCAL EGRESS CODES MAY DIFFER. ALWAYS REFER TO LOCAL BUILDING CODES FOR COMPLETE REQUIREMENTS.
 CHECK WITH LOCAL OFFICIALS TO ENSURE COMPLIANCE BEFORE INSTALLING THE UNIT.

SCALE: 1/8" = 1'

5-WIDE UNITS

UNIT SIZE
ROUGH OPENING
FRAME SIZE
DAYLIGHT OPENING

182 3/4" (4642)
180 3/4" (4591)
180" (4572)
31 1/2" (800) [5]

32 3/4" (832)
30 3/4" (781)
30" (762)
25 1/2" (648)

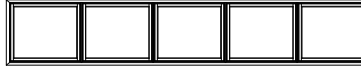

25CCMT3630-5

38 3/4" (984)
36 3/4" (934)
36" (914)
31 1/2" (800)

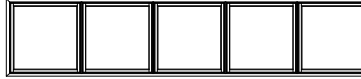

25CCMT3636-5

42 3/4" (1086)
40 3/4" (1035)
40" (1016)
35 1/2" (902)

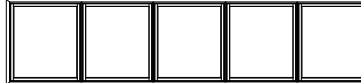

25CCMT3640-5

50 3/4" (1289)
48 3/4" (1238)
48" (1219)
43 1/2" (1105)

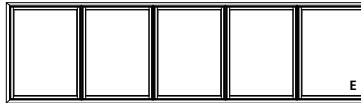

25CCMT3648-5

56 3/4" (1442)
54 3/4" (1391)
54" (1372)
49 1/2" (1257)

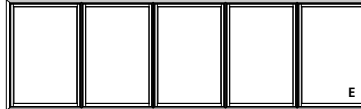

25CCMT2054-5

58 3/4" (1492)
56 3/4" (1442)
56" (1422)
51 1/2" (1308)

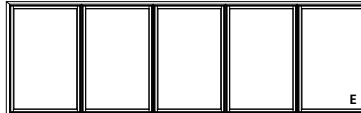

25CCMT3656-5

62 3/4" (1594)
60 3/4" (1543)
60" (1524)
55 1/2" (1410)

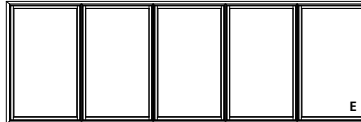

25CCMT3660-5

66 3/4" (1696)
64 3/4" (1645)
64" (1626)
59 1/2" (1511)

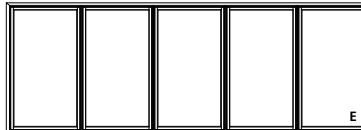

25CCMT3664-5

68 3/4" (1746)
66 3/4" (1696)
66" (1676)
61 1/2" (1562)

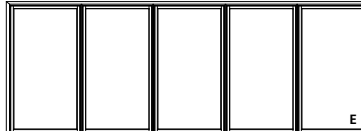

25CCMT3666-5

74 3/4" (1899)
72 3/4" (1848)
72" (1829)
67 1/2" (1715)

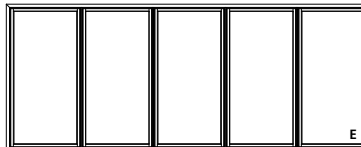

25CCMT3672-5

ELEVATION SYMBOL LEGEND:

VALUES IN () ARE IN MILLIMETER CONVERSIONS.

VALUES IN [] ARE NUMBER OF DAYLIGHT OPENINGS PER UNIT.

E UNIT MEETS EGRESS REQUIREMENTS FOR IRC CODE. STATE AND LOCAL EGRESS CODES MAY DIFFER. ALWAYS REFER TO LOCAL BUILDING CODES FOR COMPLETE REQUIREMENTS. CHECK WITH LOCAL OFFICIALS TO ENSURE COMPLIANCE BEFORE INSTALLING THE UNIT.

SCALE: 1/8" = 1'

PICTURE UNITS

UNIT SIZE	14 3/4" (375)	20 3/4" (527)	26 3/4" (679)	32 3/4" (832)	38 3/4" (984)	42 3/4" (1086)	44 3/4" (1137)
ROUGH OPENING	12 3/4" (324)	18 3/4" (476)	24 3/4" (629)	30 3/4" (781)	36 3/4" (933)	40 3/4" (1035)	42 3/4" (1086)
FRAME SIZE	12" (305)	18" (457)	24" (610)	30" (762)	36" (914)	40" (1016)	42" (1067)
DAYLIGHT OPENING	7 1/2" (191)	13 1/2" (343)	19 1/2" (495)	25 1/2" (648)	31 1/2" (800)	35 1/2" (902)	37 1/2" (953)
14 3/4" (375) 12 3/4" (324) 12" (305) 7 1/2" (191)							
20 3/4" (527) 18 3/4" (476) 18" (457) 13 1/2" (343)							
26 3/4" (679) 24 3/4" (629) 24" (610) 19 1/2" (495)							
32 3/4" (832) 30 3/4" (781) 30" (762) 25 1/2" (648)							
38 3/4" (984) 36 3/4" (933) 36" (914) 31 1/2" (800)							
42 3/4" (1086) 40 3/4" (1035) 40" (1016) 35 1/2" (902)							
44 3/4" (1137) 42 3/4" (1086) 42" (1067) 37 1/2" (953)							
50 3/4" (1289) 48 3/4" (1238) 48" (1219) 43 1/2" (1105)							

ELEVATION SYMBOL LEGEND:
VALUES IN () ARE IN MILLIMETER CONVERSIONS.

SCALE: 1/4" = 1'

PICTURE UNITS

UNIT SIZE	14 3/4" (375)	20 3/4" (527)	26 3/4" (679)	32 3/4" (832)	38 3/4" (984)	42 3/4" (1086)	44 3/4" (1137)
ROUGH OPENING	12 3/4" (324)	18 3/4" (476)	24 3/4" (629)	30 3/4" (781)	36 3/4" (933)	40 3/4" (1035)	42 3/4" (1086)
FRAME SIZE	12" (305)	18" (457)	24" (610)	30" (762)	36" (914)	40" (1016)	42" (1067)
DAYLIGHT OPENING	7 1/2" (191)	13 1/2" (343)	19 1/2" (495)	25 1/2" (648)	31 1/2" (800)	35 1/2" (902)	37 1/2" (953)

54 3/4" (1391) 52 3/4" (1340) 52" (1321) 47 1/2" (1207)								
	25CCMTP1252	25CCMTP1852	25CCMTP2452	25CCMTP3052	25CCMTP3652	25CCMTP4052	25CCMTP4252	
	56 3/4" (1441) 54 3/4" (1391) 54" (1372) 49 1/2" (1257)							
		25CCMTP1254	25CCMTP1854	25CCMTP2454	25CCMTP3054	25CCMTP3654	25CCMTP4054	25CCMTP4254
		62 3/4" (1594) 60 3/4" (1543) 60" (1524) 55 1/2" (1410)						
25CCMTP1260			25CCMTP1860	25CCMTP2460	25CCMTP3060	25CCMTP3660	25CCMTP4060	25CCMTP4260
66 3/4" (1695) 64 3/4" (1645) 64" (1626) 59 1/2" (1511)								
	25CCMTP1264		25CCMTP1864	25CCMTP2464	25CCMTP3064	25CCMTP3664	25CCMTP4064	25CCMTP4264
	68 3/4" (1746) 66 3/4" (1695) 66" (1676) 61 1/2" (1562)							
		25CCMTP1266	25CCMTP1866	25CCMTP2466	25CCMTP3066	25CCMTP3666	25CCMTP4066	25CCMTP4266

ELEVATION SYMBOL LEGEND:
 VALUES IN () ARE IN MILLIMETER CONVERSIONS.

SCALE: 1/4" = 1'

PICTURE UNITS

UNIT SIZE
ROUGH OPENING
FRAME SIZE
DAYLIGHT OPENING

14 3/4" (375)
12 3/4" (324)
12" (305)
7 1/2" (191)

20 3/4" (527)
18 3/4" (476)
18" (457)
13 1/2" (343)

26 3/4" (679)
24 3/4" (629)
24" (610)
19 1/2" (495)

32 3/4" (832)
30 3/4" (781)
30" (762)
25 1/2" (648)

38 3/4" (984)
36 3/4" (933)
36" (914)
31 1/2" (800)

42 3/4" (1086)
40 3/4" (1035)
40" (1016)
35 1/2" (902)

44 3/4" (1137)
42 3/4" (1086)
42" (1067)
37 1/2" (953)

74 3/4" (1899)
72 3/4" (1848)
72" (1829)
67 1/2" (1715)

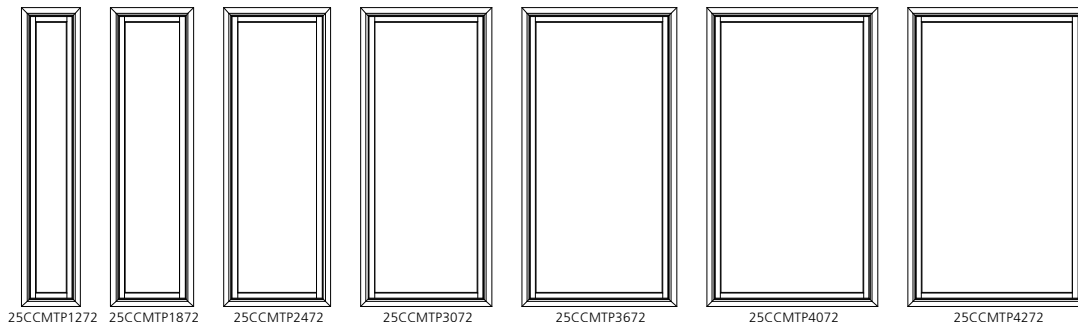

78 3/4" (2000)
76 3/4" (1949)
76" (1930)
71 1/2" (1861)

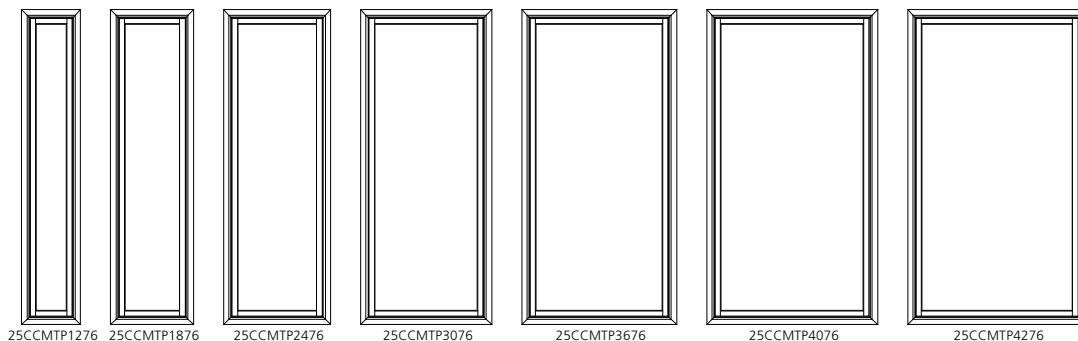



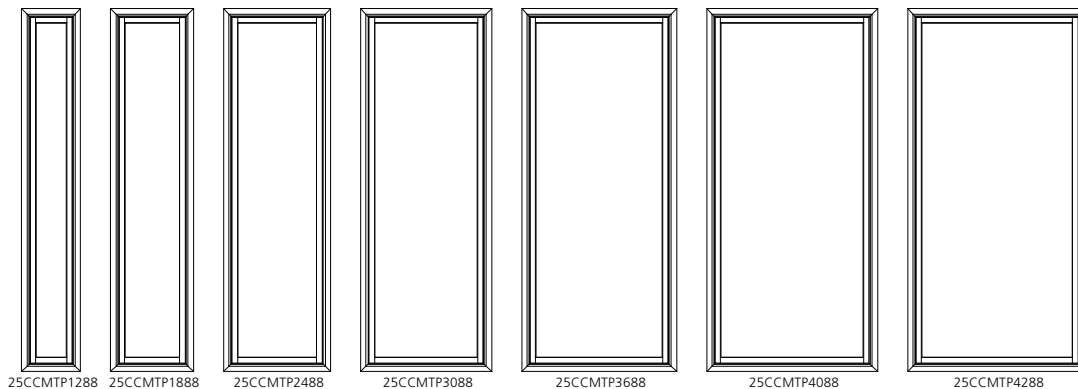

90 3/4" (2305)
88 3/4" (2254)
88" (2235)
85 1/2" (2157)

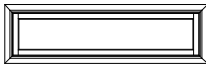
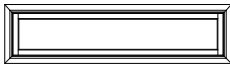
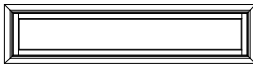
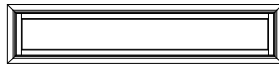
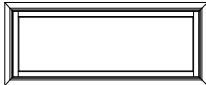
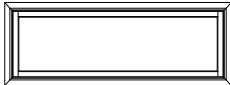
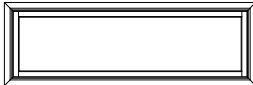
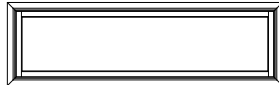

ELEVATION SYMBOL LEGEND:
VALUES IN () ARE IN MILLIMETER CONVERSIONS.

SCALE: 1/4" = 1'

PICTURE UNITS

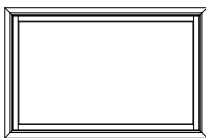
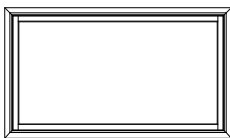
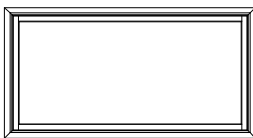
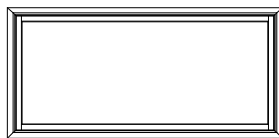
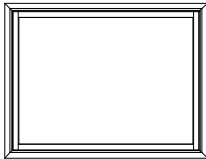
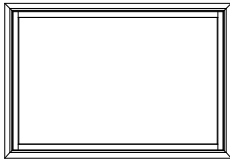
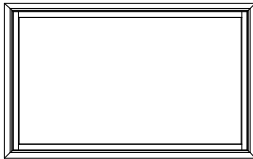
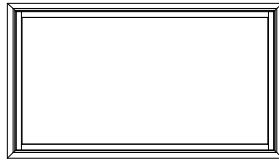
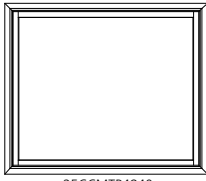
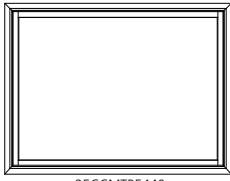
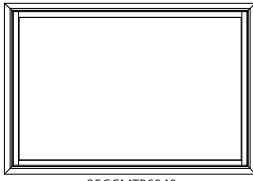
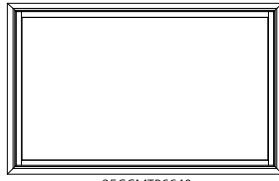
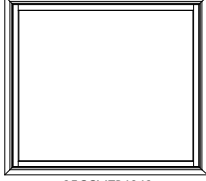
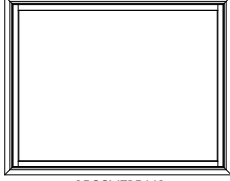
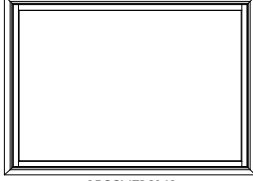
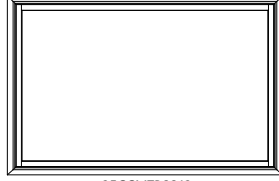
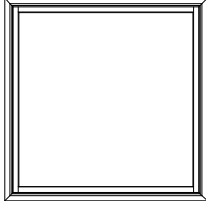
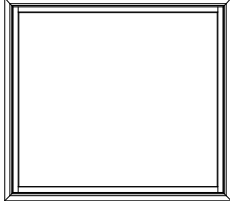
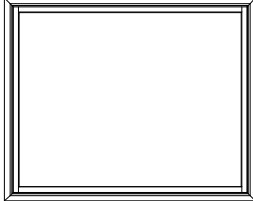
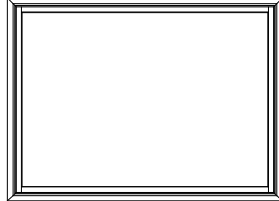
UNIT SIZE	50 3/4" (1289)	56 3/4" (1441)	62 3/4" (1594)	68 3/4" (1746)
ROUGH OPENING	48 3/4" (1238)	54 3/4" (1391)	60 3/4" (1543)	66 3/4" (1695)
FRAME SIZE	48" (1219)	54" (1372)	60" (1524)	66" (1676)
DAYLIGHT OPENING	43 1/2" (1105)	49 1/2" (1257)	55 1/2" (1410)	61 1/2" (1562)
14 3/4" (375) 12 3/4" (324) 12" (305) 7 1/2" (191)	 25CCMTP4812	 25CCMTP5412	 25CCMTP6012	 25CCMTP6612
20 3/4" (527) 18 3/4" (476) 18" (457) 13 1/2" (343)	 25CCMTP4818	 25CCMTP5418	 25CCMTP6018	 25CCMTP6618
26 3/4" (679) 24 3/4" (629) 24" (610) 19 1/2" (495)	 25CCMTP4824	 25CCMTP5424	 25CCMTP6024	 25CCMTP6624
32 3/4" (832) 30 3/4" (781) 30" (762) 25 1/2" (597)	 25CCMTP4830	 25CCMTP5430	 25CCMTP6030	 25CCMTP6630
38 3/4" (984) 36 3/4" (933) 36" (914) 31 1/2" (800)	 25CCMTP4836	 25CCMTP5436	 25CCMTP6036	 25CCMTP6636
42 3/4" (1086) 40 3/4" (1035) 40" (1016) 35 1/2" (902)	 25CCMTP4840	 25CCMTP5440	 25CCMTP6040	 25CCMTP6640
44 3/4" (1137) 42 3/4" (1086) 42" (1067) 37 1/2" (953)	 25CCMTP4842	 25CCMTP5442	 25CCMTP6042	 25CCMTP6642
50 3/4" (1289) 48 3/4" (1238) 48" (1219) 43 1/2" (1105)	 25CCMTP4848	 25CCMTP5448	 25CCMTP6048	 25CCMTP6648

ELEVATION SYMBOL LEGEND:
VALUES IN () ARE IN MILLIMETER CONVERSIONS.

SCALE: 1/4" = 1'

PICTURE UNITS

UNIT SIZE
ROUGH OPENING
FRAME SIZE
DAYLIGHT OPENING

50 3/4" (1289)
48 3/4" (1238)
48" (1219)
43 1/2" (1105)

56 3/4" (1441)
54 3/4" (1391)
54" (1372)
49 1/2" (1257)

62 3/4" (1594)
60 3/4" (1543)
60" (1524)
55 1/2" (1410)

68 3/4" (1746)
66 3/4" (1695)
66" (1676)
61 1/2" (1562)

54 3/4" (1391)
52 3/4" (1340)
52" (1321)
47 1/2" (1207)

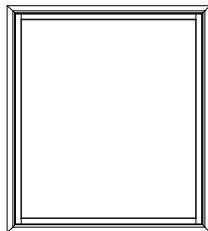

25CCMTP4852

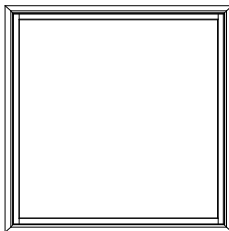

25CCMTP5452

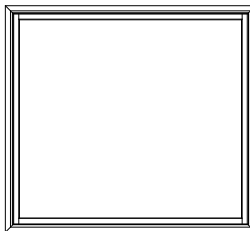

25CCMTP6052

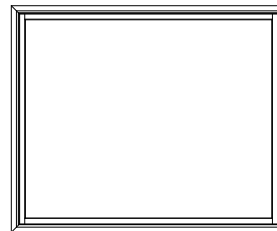

25CCMTP6652

56 3/4" (1441)
54 3/4" (1391)
54" (1372)
49 1/2" (1257)

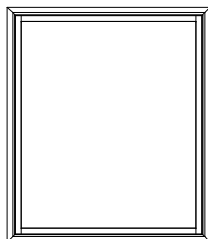

25CCMTP4854

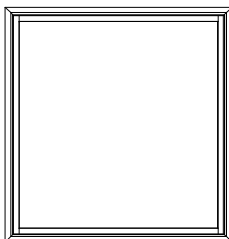

25CCMTP5454

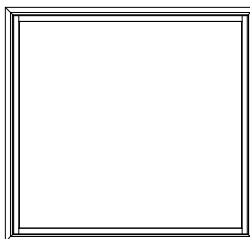

25CCMTP6054

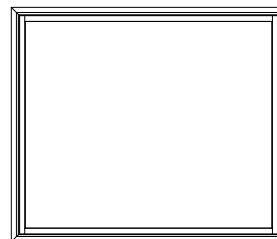

25CCMTP6654

62 3/4" (1594)
60 3/4" (1543)
60" (1524)
55 1/2" (1410)

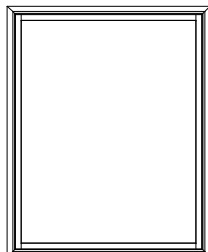

25CCMTP4860

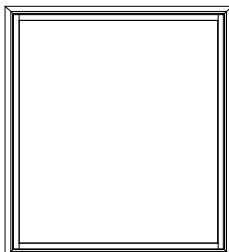

25CCMTP5460

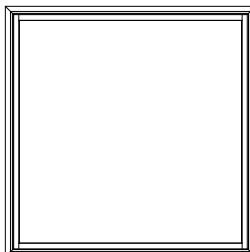

25CCMTP6060

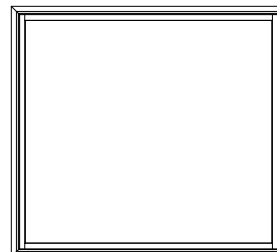

25CCMTP6660

66 3/4" (1695)
64 3/4" (1645)
64" (1626)
59 1/2" (1511)

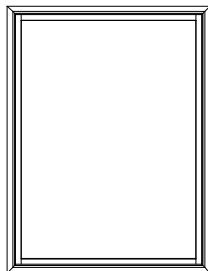

25CCMTP4864

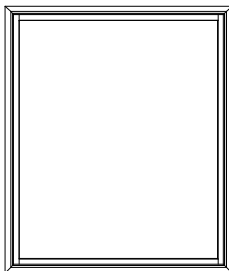

25CCMTP5464

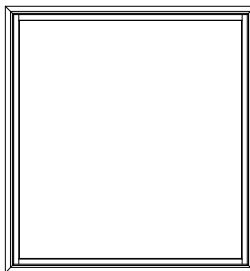

25CCMTP6064

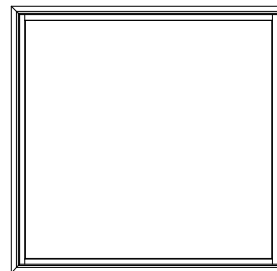

25CCMTP6664

68 3/4" (1746)
66 3/4" (1695)
66" (1676)
61 1/2" (1562)

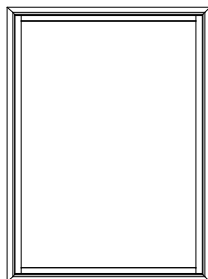

25CCMTP4866

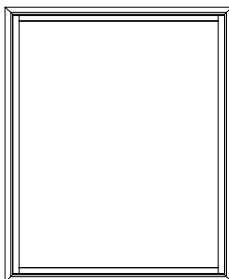

25CCMTP5466

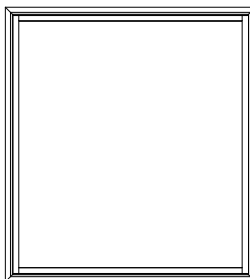

25CCMTP6066

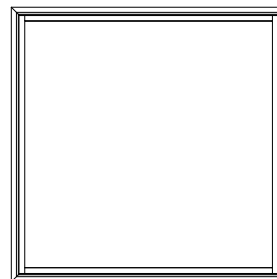

25CCMTP6666

ELEVATION SYMBOL LEGEND:
VALUES IN () ARE IN MILLIMETER CONVERSIONS.

SCALE: 1/4" = 1'

PICTURE UNITS

UNIT SIZE
ROUGH OPENING
FRAME SIZE
DAYLIGHT OPENING

50 3/4" (1289)
48 3/4" (1238)
48" (1219)
43 1/2" (1105)

56 3/4" (1441)
54 3/4" (1391)
54" (1372)
49 1/2" (1257)

62 3/4" (1594)
60 3/4" (1543)
60" (1524)
55 1/2" (1410)

68 3/4" (1746)
66 3/4" (1695)
66" (1676)
61 1/2" (1562)

74 3/4" (1899)
72 3/4" (1848)
72" (1829)
67 1/2" (1715)

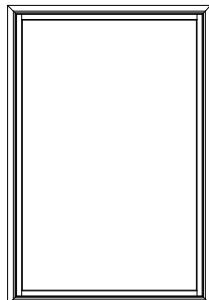

25CCMTP4872

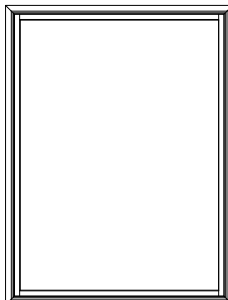

25CCMTP5472

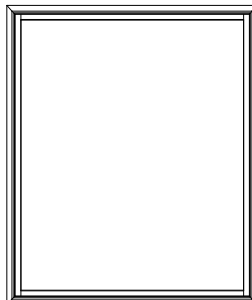

25CCMTP6072

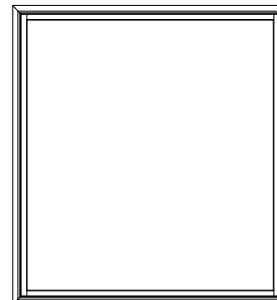

25CCMTP6672

78 3/4" (2000)
76 3/4" (1949)
76" (1930)
71 1/2" (1861)

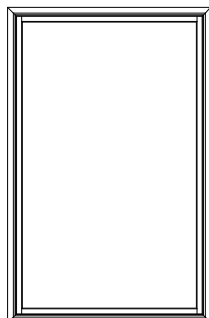

25CCMTP4876

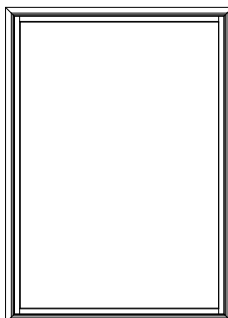

25CCMTP5476

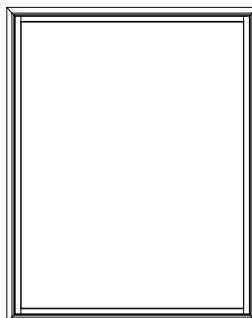

25CCMTP6076

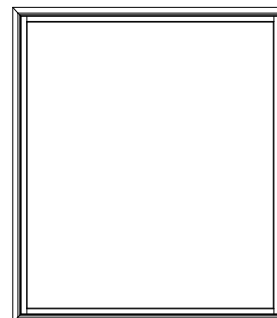

25CCMTP6676

90 3/4" (2305)
88 3/4" (2254)
88" (2235)
86 1/2" (2197)

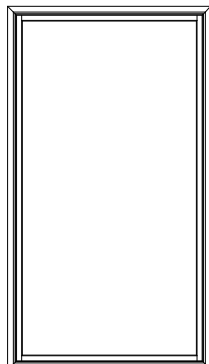

25CCMTP4888

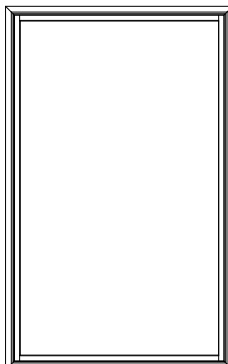

25CCMTP5488

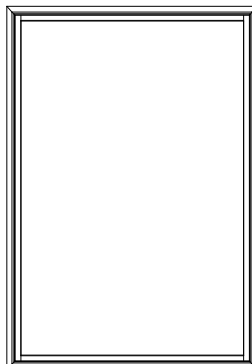

25CCMTP6088

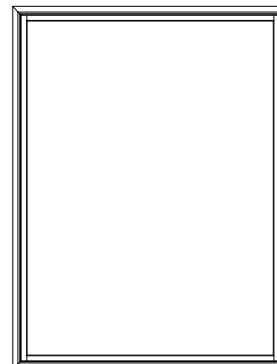

25CCMTP6688

ELEVATION SYMBOL LEGEND:
VALUES IN () ARE IN MILLIMETER CONVERSIONS.

SCALE: 1/4" = 1'

PICTURE UNITS

UNIT SIZE
ROUGH OPENING
FRAME SIZE
DAYLIGHT OPENING

74 3/4" (1899)
72 3/4" (1848)
72" (1829)
67 1/2" (1715)

14 3/4" (375)
12 3/4" (324)
13 3/4" (350)
7 1/2" (191)



25CCMTP7212

20 3/4" (527)
18 3/4" (476)
18 3/4" (476)
13 1/2" (343)



25CCMTP7218

26 3/4" (679)
24 3/4" (629)
24 3/4" (629)
19 1/2" (493)



25CCMTP7224

32 3/4" (832)
30 3/4" (781)
30 3/4" (781)
25 1/2" (647)

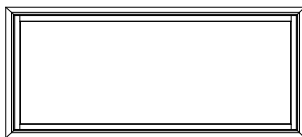

25CCMTP7230

38 3/4" (984)
36 3/4" (933)
36 3/4" (933)
31 1/2" (800)



25CCMTP7236

42 3/4" (1086)
40 3/4" (1035)
40 3/4" (1035)
35 1/2" (902)

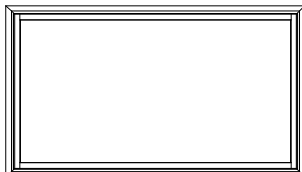

25CCMTP7240

44 3/4" (1137)
42 3/4" (1086)
42 3/4" (1086)
37 1/2" (953)



25CCMTP7242

50 3/4" (1289)
48 3/4" (1238)
48 3/4" (1238)
43 1/2" (1105)

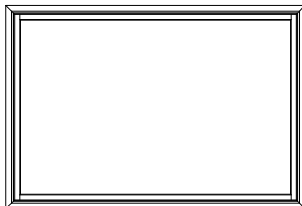

25CCMTP7248

UNIT SIZE
ROUGH OPENING
FRAME SIZE
DAYLIGHT OPENING

74 3/4" (1899)
72 3/4" (1848)
72" (1829)
67 1/2" (1715)

54 3/4" (1391)
52 3/4" (1340)
52" (1321)
47 1/2" (1207)

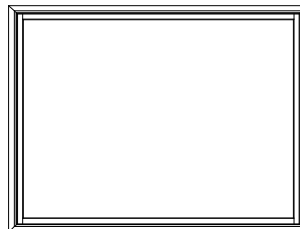

25CCMTP7252

56 3/4" (1441)
54 3/4" (1391)
54" (1372)
49 1/2" (1257)

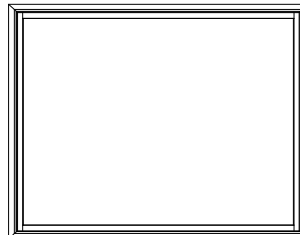

25CCMTP7254

62 3/4" (1594)
60 3/4" (1543)
60" (1524)
55 1/2" (1410)

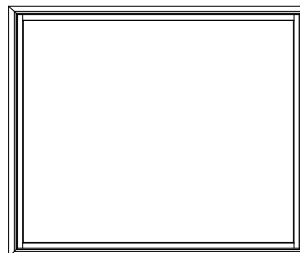

25CCMTP7260

66 3/4" (1695)
64 3/4" (1645)
64" (1626)
59 1/2" (1511)

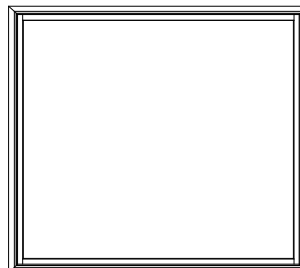

25CCMTP7264

68 3/4" (1746)
66 3/4" (1695)
66" (1676)
61 1/2" (1562)

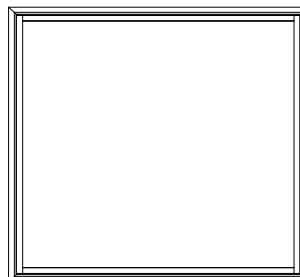

25CCMTP7266

ELEVATION SYMBOL LEGEND:
VALUES IN () ARE IN MILLIMETER CONVERSIONS.

SCALE: 1/4" = 1'

PICTURE UNITS

UNIT SIZE
ROUGH OPENING
FRAME SIZE
DAYLIGHT OPENING

74 3/4" (1899)
72 3/4" (1848)
72" (1829)
67 1/2" (1715)

74 3/4" (1899)
72 3/4" (1848)
72" (1829)
67 1/2" (1715)

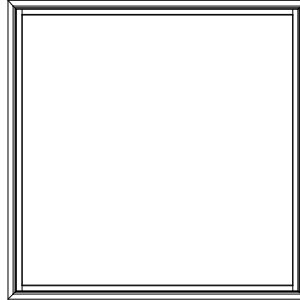

25CCMTP7272

78 3/4" (2000)
76 3/4" (1949)
76" (1930)
71 1/2" (1861)

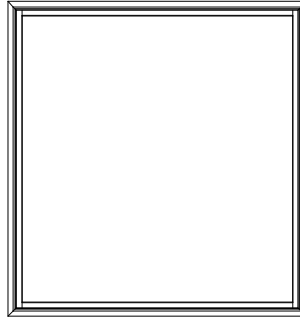

25CCMTP7276

90 3/4" (2305)
88 3/4" (2254)
88" (2235)
86 1/2" (2197)

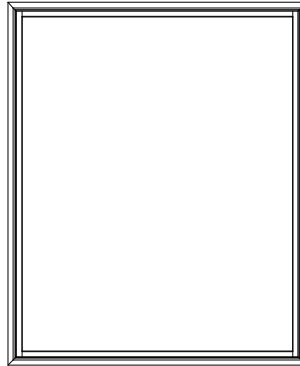





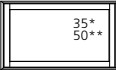

25CCMTP7288

ELEVATION SYMBOL LEGEND:
VALUES IN () ARE IN MILLIMETER CONVERSIONS.

SCALE: 1/4" = 1'

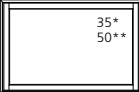
PICTURE UNITS - NOMINAL

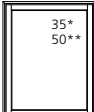
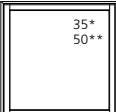
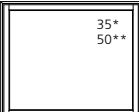
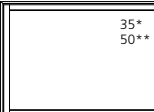
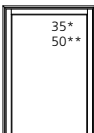
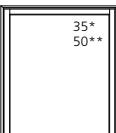
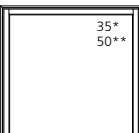
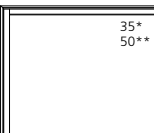
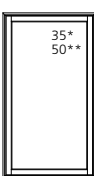
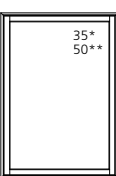
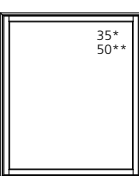
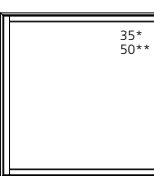
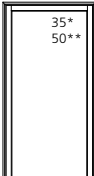
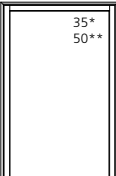
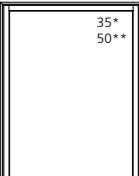
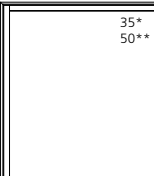
UNIT SIZE	26" (660)	32" (813)	38" (965)	44" (1118)
ROUGH OPENING	24" (610)	30" (762)	36" (914)	42" (1067)
FRAME SIZE	23 1/4" (591)	29 1/4" (743)	35 1/4" (895)	41 1/4" (1048)
DAYLIGHT OPENING	18 3/4" (476)	24 3/4" (629)	30 3/4" (781)	36 3/4" (933)
20" (508) 18" (457) 17 1/4" (438) 12 3/4" (324)	 35* 50**	 35* 50**	 35* 50**	 35* 50**
26" (660) 24" (610) 23 1/4" (591) 18 3/4" (476)	 35* 50**	 35* 50**	 35* 50**	 35* 50**
32" (813) 30" (762) 29 1/4" (743) 24 3/4" (629)	 35* 50**	 35* 50**	 35* 50**	 35* 50**
38" (965) 36" (914) 35 1/4" (895) 30 3/4" (781)	 35* 50**	 35* 50**	 35* 50**	 35* 50**
44" (1118) 42" (1067) 41 1/4" (1048) 36 3/4" (933)	 35* 50**	 35* 50**	 35* 50**	 35* 50**
50" (1270) 48" (1219) 47 1/4" (1200) 42 3/4" (1086)	 35* 50**	 35* 50**	 35* 50**	 35* 50**

ELEVATION SYMBOL LEGEND:
 VALUES IN () ARE IN MILLIMETER CONVERSIONS.
 *** NUMBER INDICATES DESIGN PRESSURE (DP) RATING WITH STANDARD GLAZING.
 **** NUMBER INDICATES OPTIONAL DESIGN PRESSURE (DP) RATING.

SCALE: 1/4" = 1'

















PICTURE UNITS - NOMINAL

UNIT SIZE ROUGH OPENING FRAME SIZE DAYLIGHT OPENING	26" (660) 24" (610) 23 1/4" (591) 18 3/4" (476)	32" (813) 30" (762) 29 1/4" (743) 24 3/4" (629)	38" (965) 36" (914) 35 1/4" (895) 30 3/4" (781)	44" (1118) 42" (1067) 41 1/4" (1048) 36 3/4" (933)
56" (1422) 54" (1372) 53 1/4" (1353) 48 3/4" (1238)				
62" (1575) 60" (1524) 59 1/4" (1505) 54 3/4" (1391)				
68" (1727) 66" (1676) 65 1/4" (1657) 60 3/4" (1543)				
74" (1880) 72" (1829) 71 1/4" (1810) 66 3/4" (1695)				

ELEVATION SYMBOL LEGEND:
VALUES IN () ARE IN MILLIMETER CONVERSIONS.
##* NUMBER INDICATES DESIGN PRESSURE (DP) RATING WITH STANDARD GLAZING.
###* NUMBER INDICATES OPTIONAL DESIGN PRESSURE (DP) RATING.

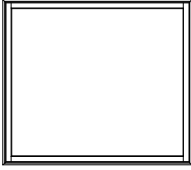
SCALE: 1/4" = 1'

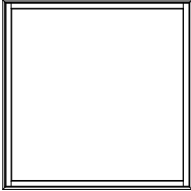

PICTURE UNITS - NOMINAL

UNIT SIZE ROUGH OPENING FRAME SIZE DAYLIGHT OPENING	50"(1270) 48"(1219) 47 1/4"(1200) 42 3/4"(1086)	62"(1575) 60"(1524) 59 1/4"(1505) 54 3/4"(1391)	74"(1880) 72"(1829) 71 1/4"(1810) 66 3/4"(1695)
20"(508) 18"(457) 17 1/4"(438) 12 3/4"(324)	 25CCMTP4818N	 25CCMTP6018N	 25CCMTP7218N
26"(660) 24"(610) 23 1/4"(591) 18 3/4"(476)	 25CCMTP4824N	 25CCMTP6024N	 25CCMTP7224N
32"(813) 30"(762) 29 1/4"(743) 24 3/4"(629)	 25CCMTP4830N	 25CCMTP6030N	 25CCMTP7230N
38"(965) 36"(914) 35 1/4"(895) 30 3/4"(781)	 25CCMTP4836N	 25CCMTP6036N	 25CCMTP7236N
44"(1118) 42"(1067) 41 1/4"(1048) 36 3/4"(933)	 25CCMTP4842N	 25CCMTP6042N	 25CCMTP7242N
50"(1270) 48"(1219) 47 1/4"(1200) 42 3/4"(1086)	 25CCMTP4848N	 25CCMTP6048N	 25CCMTP7248N

ELEVATION SYMBOL LEGEND:
VALUES IN () ARE IN MILLIMETER CONVERSIONS.

SCALE: 1/4" = 1'

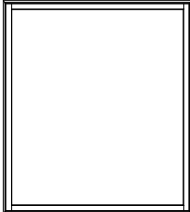
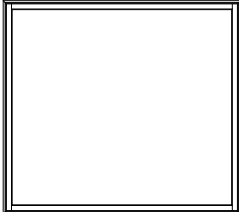
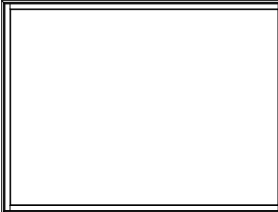
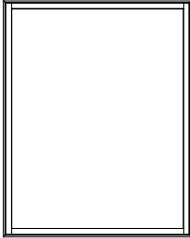
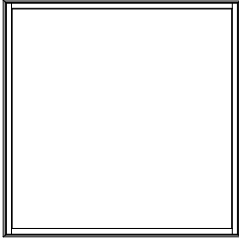

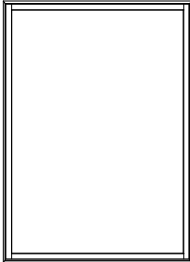
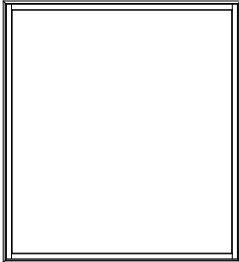
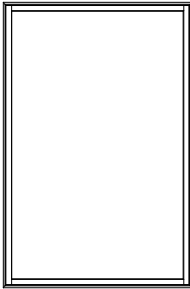
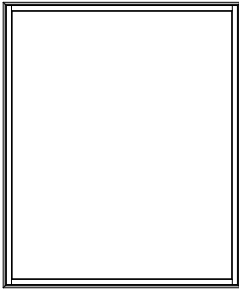
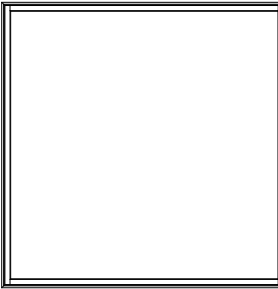





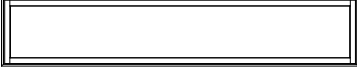
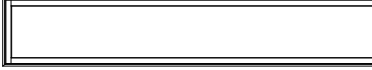

PICTURE UNITS - NOMINAL

UNIT SIZE ROUGH OPENING FRAME SIZE DAYLIGHT OPENING	50"(1270) 48"(1219) 47 1/4"(1200) 42 3/4"(1086)	62"(1575) 60"(1524) 59 1/4"(1505) 54 3/4"(1391)	74"(1880) 72"(1829) 71 1/4"(1810) 66 3/4"(1695)
56"(1422) 54"(1372) 53 1/4"(1353) 48 3/4"(1238)	 25CCMTP4854N	 25CCMTP6054N	 25CCMTP7254N
62"(1575) 60"(1524) 59 1/4"(1505) 54 3/4"(1391)	 25CCMTP460N	 25CCMTP6060N	 25CCMTP7260N
68"(1727) 66"(1676) 65 1/4"(1657) 60 3/4"(1543)	 25CCMTP4866N	 25CCMTP6066N	 25CCMTP7266N
74"(1880) 72"(1829) 71 1/4"(1810) 66 3/4"(1695)	 25CCMTP4872N	 25CCMTP6072N	 25CCMTP7272N

ELEVATION SYMBOL LEGEND:
VALUES IN () ARE IN MILLIMETER CONVERSIONS.

SCALE: 1/4" = 1'

PICTURE UNITS - NOMINAL

UNIT SIZE ROUGH OPENING FRAME SIZE DAYLIGHT OPENING	92" (2337) 90" (2286) 89 1/4" (2267) 84 3/4" (2153)	98" (2489) 96" (2438) 95 1/4" (2419) 90 3/4" (2305)
20" (508) 18" (457) 17 1/4" (438) 12 3/4" (324)	 25CCMTP9018N	 25CCMTP9618N
26" (660) 24" (610) 23 1/4" (591) 18 3/4" (476)	 25CCMTP9024N	 25CCMTP96224N
32" (813) 30" (762) 29 1/4" (743) 24 3/4" (629)	 25CCMTP9030N	 25CCMTP9630N
38" (965) 36" (914) 35 1/4" (895) 30 3/4" (781)	 25CCMTP9036N	 25CCMTP9636N
44" (1118) 42" (1067) 41 1/4" (1048) 36 3/4" (933)	 25CCMTP9042N	 25CCMTP9642N
50" (1270) 48" (1219) 47 1/4" (1200) 42 3/4" (1086)	 25CCMTP9048N	 25CCMTP9648N

ELEVATION SYMBOL LEGEND:
VALUES IN () ARE IN MILLIMETER CONVERSIONS.

SCALE: 1/4" = 1'

PICTURE UNITS - NOMINAL

UNIT SIZE
ROUGH OPENING
FRAME SIZE
DAYLIGHT OPENING

92"(2337)
90"(2286)
89 1/4"(2267)
84 3/4"(2153)

98"(2489)
96"(2438)
95 1/4"(2419)
90 3/4"(2305)

56"(1422)
54"(1372)
53 1/4"(1353)
48 3/4"(1238)

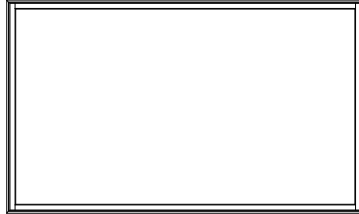

25CCMTP9054N

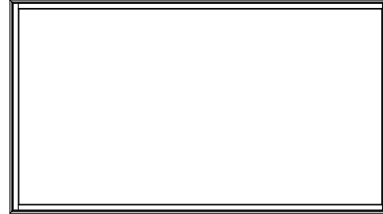

25CCMTP9654N

62"(1575)
60"(1524)
59 1/4"(1505)
54 3/4"(1391)

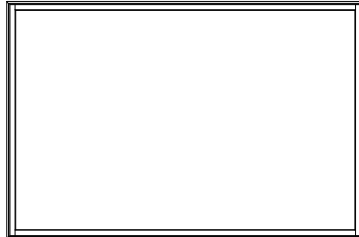

25CCMTP9060N

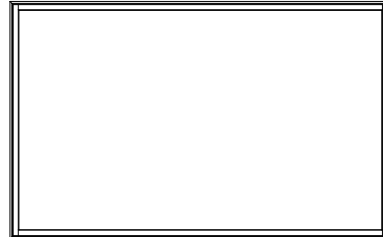

25CCMTP9660N

68"(1727)
66"(1676)
65 1/4"(1657)
60 3/4"(1543)

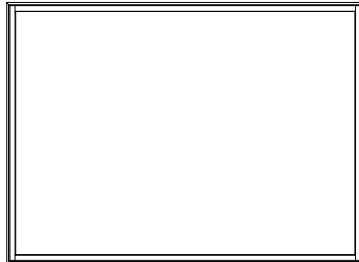

25CCMTP9066N

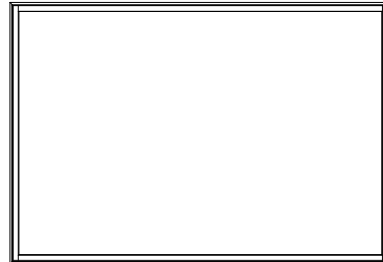

25CCMTP9666N

74"(1880)
72"(1829)
71 1/4"(1810)
66 3/4"(1695)

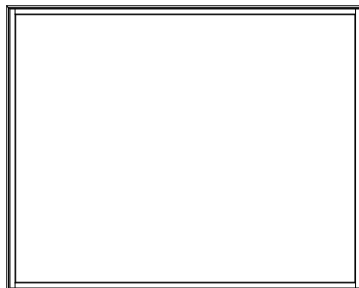

25CCMTP9072N

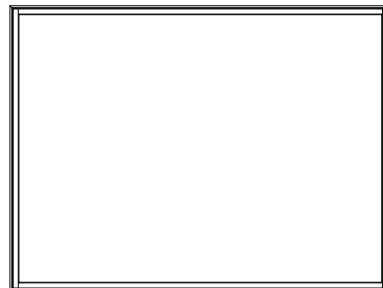

25CCMTP9672N

ELEVATION SYMBOL LEGEND:
VALUES IN () ARE IN MILLIMETER CONVERSIONS.

SCALE: 1/4" = 1'

PICTURE UNITS - NOMINAL

UNIT SIZE	110" (2794)
ROUGH OPENING	108" (2743)
FRAME SIZE	107 1/4" (2724)
DAYLIGHT OPENING	102 3/4" (2610)



25CCMTP10818N



25CCMTP10824N



25CCMTP10830N



25CCMTP10836N



25CCMTP10842N

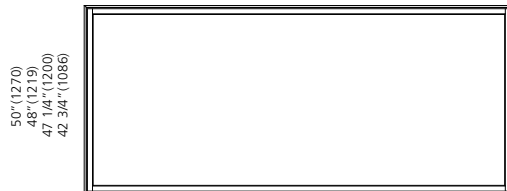

25CCMTP10848N

ELEVATION SYMBOL LEGEND:
VALUES IN () ARE IN MILLIMETER CONVERSIONS.

SCALE: 1/4" = 1'

PICTURE UNITS - NOMINAL

UNIT SIZE	110" (2794)
ROUGH OPENING	108" (2743)
FRAME SIZE	107 1/4" (2724)
DAYLIGHT OPENING	102 3/4" (2610)

56" (1422)
54" (1372)
53 1/4" (1353)
48 3/4" (1238)



25CCMTP10854N

62" (1575)
60" (1524)
59 1/4" (1505)
54 3/4" (1391)

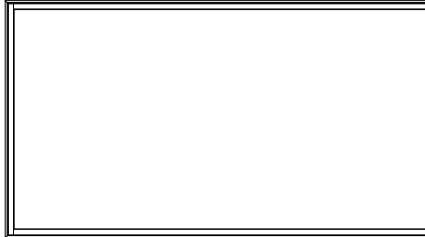

25CCMTP10860N

68" (1727)
66" (1676)
65 1/4" (1657)
60 3/4" (1543)

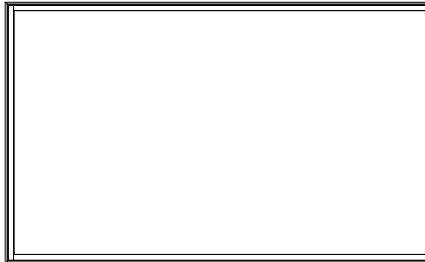

25CCMTP10866N

74" (1880)
72" (1829)
71 1/4" (1810)
66 3/4" (1695)

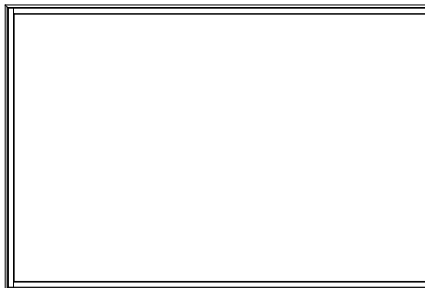











25CCMTP10872N

ELEVATION SYMBOL LEGEND:
VALUES IN () ARE IN MILLIMETER CONVERSIONS.

SCALE: 1/4" = 1'











TRANSOM UNITS - 2-WIDE

UNIT SIZE	42 3/4" (1086)	50 3/4" (1289)	58 3/4" (1492)	62 3/4" (1594)	74 3/4" (1899)
ROUGH OPENING	40 3/4" (1035)	48 3/4" (1238)	56 3/4" (1442)	60 3/4" (1543)	72 3/4" (1848)
FRAME SIZE	40" (1016)	48" (1219)	56" (1422)	60" (1524)	72" (1829)
DAYLIGHT OPENING	15 9/16" (395)[2]	19 9/16" (497)[2]	23 9/16" (599)[2]	25 9/16" (649)[2]	31 9/16" (802)[2]
17 3/4" (451) 15 3/4" (400) 15" (381) 10 9/16" (268)					
26 3/4" (680) 24 3/4" (629) 24" (610) 19 9/16" (497)					

ELEVATION SYMBOL LEGEND:
VALUES IN () ARE IN MILLIMETER CONVERSIONS.
VALUES IN [] ARE NUMBER OF DAYLIGHT OPENINGS PER UNIT.

SCALE: 1/8" = 1'











TRANSOM UNITS - 3-WIDE

UNIT SIZE ROUGH OPENING FRAME SIZE DAYLIGHT OPENING	62 3/4" (1594) 60 3/4" (1543) 60" (1524) 15 9/16" (395)[3]	74 3/4" (1899) 72 3/4" (1848) 72" (1829) 19 9/16" (497)[3]	86 3/4" (2204) 84 3/4" (2153) 84" (2134) 23 9/16" (599)[3]	92 3/4" (2356) 90 3/4" (2305) 90" (2286) 25 9/16" (649)[3]	42 3/4" (2813) 108 3/4" (2762) 108" (2743) 31 9/16" (802)[3]
17 3/4" (451) 15 3/4" (400) 15" (381) 10 9/16" (268)	 25CCMTT2015-3	 25CCMT2415-3	 25CCMT2815-3	 25CCMT3015-3	 25CCMT3615-3
26 3/4" (680) 24 3/4" (629) 24" (610) 19 9/16" (497)	 25CCMTT2024-3	 25CCMT2424-3	 25CCMT2824-3	 25CCMT3024-3	 25CCMT3624-3

ELEVATION SYMBOL LEGEND:
VALUES IN () ARE IN MILLIMETER CONVERSIONS.
VALUES IN [] ARE NUMBER OF DAYLIGHT OPENINGS PER UNIT.

SCALE: 1/8" = 1'









TRANSOM UNITS - 4-WIDE

UNIT SIZE	82 3/4" (2102)	98 3/4" (2508)	114 3/4" (2915)	122 3/4" (3118)
ROUGH OPENING	80 3/4" (2051)	96 3/4" (2458)	112 3/4" (2864)	120 3/4" (3067)
FRAME SIZE	80" (2032)	96" (2438)	112" (2845)	120" (3048)
DAYLIGHT OPENING	15 9/16" (395)[4]	19 9/16" (497)[4]	23 9/16" (599)[4]	25 9/16" (649)[4]
17 3/4" (451)				
15 3/4" (400)	25CCMTT2015-4	25CCMTT2415-4	25CCMTT2815-4	25CCMTT3015-4
15" (381)				
10 9/16" (268)				
26 3/4" (680)				
24 3/4" (629)	25CCMTT2024-4	25CCMTT2424-4	25CCMTT2824-4	25CCMTT3024-4
24" (610)				
19 9/16" (497)				
UNIT SIZE	146 3/4" (3728)			
ROUGH OPENING	144 3/4" (3677)			
FRAME SIZE	144" (3658)			
DAYLIGHT OPENING	31 9/16" (802)[4]			
17 3/4" (451)				
15 3/4" (400)	25CCMTT3615-4			
15" (381)				
10 9/16" (268)				
26 3/4" (680)				
24 3/4" (629)	25CCMTT3624-4			
24" (610)				
19 9/16" (497)				

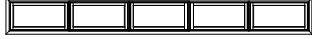
ELEVATION SYMBOL LEGEND:
VALUES IN () ARE IN MILLIMETER CONVERSIONS.
VALUES IN [] ARE NUMBER OF DAYLIGHT OPENINGS PER UNIT.

SCALE: 1/8" = 1'

TRANSOM UNITS - 5-WIDE

UNIT SIZE	102 3/4" (2610)	122 3/4" (3118)	142 3/4" (3626)	152 3/4" (3880)
ROUGH OPENING	100 3/4" (2559)	120 3/4" (3067)	140 3/4" (3575)	150 3/4" (3829)
FRAME SIZE	100" (2540)	120" (3048)	140" (3556)	150" (3810)
DAYLIGHT OPENING	15 9/16" (395)[5]	19 9/16" (497)[5]	23 9/16" (599)[5]	25 9/16" (649)[5]
17 3/4" (451)				
15 3/4" (400)	25CCMTT2015-5	25CCMTT2415-5	25CCMTT2815-5	25CCMTT3015-5
15" (381)				
10 9/16" (268)				
26 3/4" (680)				
24 3/4" (629)	25CCMTT2415-5	25CCMTT2424-5	25CCMTT2824-5	25CCMTT3024-5
24" (610)				
19 9/16" (497)				
UNIT SIZE	182 3/4" (4642)			
ROUGH OPENING	180 3/4" (4591)			
FRAME SIZE	180" (4572)			
DAYLIGHT OPENING	31 9/16" (802)[5]			
17 3/4" (451)				
15 3/4" (400)	25CCMTT3615-5			
15" (381)				
10 9/16" (268)				
26 3/4" (680)				
24 3/4" (629)	25CCMTT3624-5			
24" (610)				
19 9/16" (497)				

ELEVATION SYMBOL LEGEND:
VALUES IN () ARE IN MILLIMETER CONVERSIONS.
VALUES IN [] ARE NUMBER OF DAYLIGHT OPENINGS PER UNIT.

SCALE: 1/8" = 1'

TRANSOM UNITS - NOMINAL

UNIT SIZE	26"(660)	32"(813)	34"(864)	38"(965)
ROUGH OPENING	24"(610)	30"(762)	32"(813)	36"(914)
FRAME SIZE	23 1/4"(591)	29 1/4"(743)	31 1/4"(974)	35 1/4"(895)
DAYLIGHT OPENING	18 3/4"(476)	24 3/4"(629)	26 3/4"(679)	30 3/4"(781)
	20"(508) 18"(457) 17 1/4"(438) 12 3/4"(324)			
	25CCMTT2418N	25CCMTT3018N	25CCMTT3218N	25CCMTT3618N
	26"(660) 24"(610) 23 1/4"(591) 18 3/4"(476)			
	25CCMTT2424N	25CCMTT3024N	25CCMTT3224N	25CCMTT3624N

ELEVATION SYMBOL LEGEND:
VALUES IN () ARE IN MILLIMETER CONVERSIONS.
NUMBER INDICATES DESIGN PRESSURE (DP) RATING WITH STANDARD GLAZING.
NUMBER INDICATES OPTIONAL DESIGN PRESSURE (DP) RATING.

SCALE: 1/4" = 1'

HALF ROUND UNITS

UNIT SIZE
ROUGH OPENING
FRAME SIZE
DAYLIGHT OPENING

26 3/4" (679)
24 3/4" (629)
24" (610)
19 1/2" (495)

14 3/4" (375)
12 3/4" (324)
12" (305)
7 1/2" (191)



25CCMTHR24

30 3/4" (781)
28 3/4" (730)
28" (711)
23 1/2" (597)



25CCMTHR28

32 3/4" (832)
30 3/4" (781)
30" (762)
25 1/2" (648)



25CCMTHR30

38 3/4" (984)
36 3/4" (933)
36" (914)
31 1/2" (800)



25CCMTHR36

42 3/4" (1086)
40 3/4" (1035)
40" (1016)
35 1/2" (902)



25CCMTHR40

UNIT SIZE
ROUGH OPENING
FRAME SIZE
DAYLIGHT OPENING

50 3/4" (1289)
48 3/4" (1238)
48" (1219)
43 1/2" (1105)

26 3/4" (679)
24 3/4" (629)
24" (610)
19 1/2" (495)

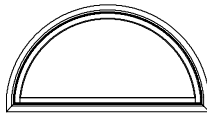

25CCMTHR48

58 3/4" (1492)
56 3/4" (1441)
56" (1422)
51 1/2" (1308)

30 3/4" (781)
28 3/4" (730)
28" (711)
23 1/2" (597)

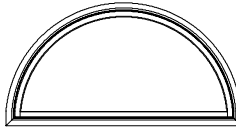

25CCMTHR56

32 3/4" (832)
30 3/4" (781)
30" (762)
25 1/2" (648)

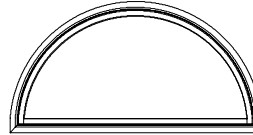

25CCMTHR60

UNIT SIZE
ROUGH OPENING
FRAME SIZE
DAYLIGHT OPENING

66 3/4" (1695)
64 3/4" (1645)
64" (1626)
59 1/2" (1511)

34 3/4" (883)
32 3/4" (832)
32" (813)
27 1/2" (699)

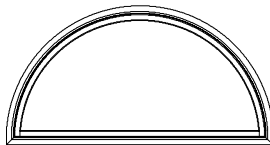

25CCMTHR64

74 3/4" (1899)
72 3/4" (1848)
72" (1829)
67 1/2" (1715)

38 3/4" (984)
36 3/4" (933)
36" (914)
31 1/2" (800)

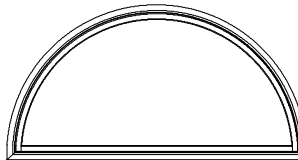

25CCMTHR72

44 3/4" (1137)
42 3/4" (1086)
42" (1067)
37 1/2" (953)

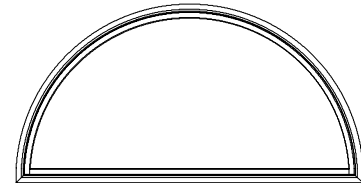

25CCMTHR84

UNIT SIZE
ROUGH OPENING
FRAME SIZE
DAYLIGHT OPENING

110 3/4" (2813)
108 3/4" (2762)
108" (2743)
103 1/2" (2629)

56 3/4" (1441)
54 3/4" (1391)
54" (1372)
49 1/2" (1257)

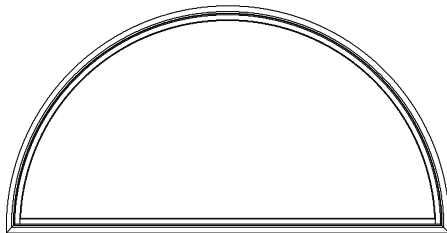

25CCMTHR108

ELEVATION SYMBOL LEGEND:
VALUES IN () ARE IN MILLIMETER CONVERSIONS.

SCALE: 1/4" = 1'

QUARTER ROUND UNITS

UNIT SIZE 22 3/4" (578)
ROUGH OPENING 20 3/4" (527)
FRAME SIZE 20" (508)
DAYLIGHT OPENING 15 1/2" (394)



22 3/4" (578)
 20 3/4" (527)
 20" (508)
 15 1/2" (394)

25CCMTQR20

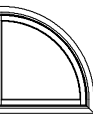

26 3/4" (679)
 24 3/4" (629)
 24" (610)
 19 1/2" (495)

25CCMTQR24

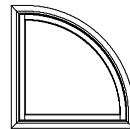

30 3/4" (781)
 28 3/4" (730)
 28" (711)
 23 1/2" (597)

25CCMTQR28

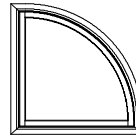

32 3/4" (832)
 30 3/4" (781)
 30" (762)
 25 1/2" (648)

25CCMTQR30

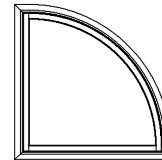

38 3/4" (984)
 36 3/4" (933)
 36" (914)
 31 1/2" (800)

25CCMTQR36

UNIT SIZE 50 3/4" (1289)
ROUGH OPENING 48 3/4" (1238)
FRAME SIZE 48" (1219)
DAYLIGHT OPENING 43 1/2" (1105)

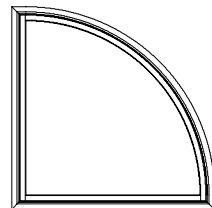

50 3/4" (1289)
 48 3/4" (1238)
 48" (1219)
 43 1/2" (1105)

25CCMTQR48

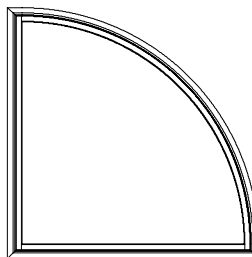

62 3/4" (1594)
 60 3/4" (1543)
 60" (1524)
 55 1/2" (1410)

25CCMTQR60

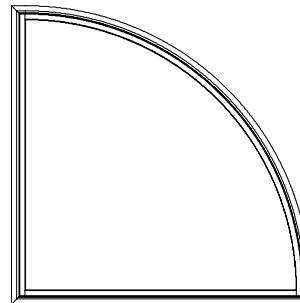

74 3/4" (1899)
 72 3/4" (1848)
 72" (1829)
 67 1/2" (1715)

25CCMTQR72

UNIT SIZE 86 3/4" (2203)
ROUGH OPENING 84 3/4" (2153)
FRAME SIZE 84" (2134)
DAYLIGHT OPENING 79 1/2" (2019)

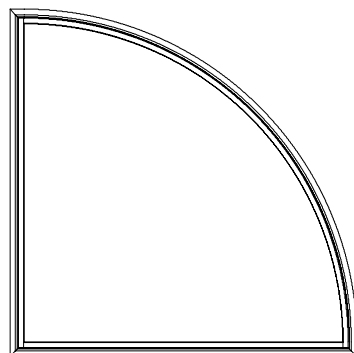

86 3/4" (2203)
 84 3/4" (2153)
 84" (2134)
 79 1/2" (2019)









25CCMTQR84

86 3/4" (2203)
 84 3/4" (2153)
 84" (2134)
 79 1/2" (2019)

ELEVATION SYMBOL LEGEND:
 VALUES IN () ARE IN MILLIMETER CONVERSIONS.

SCALE: 1/4" = 1'

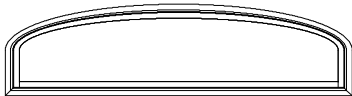
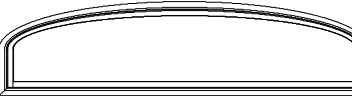
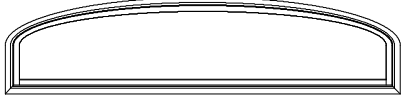
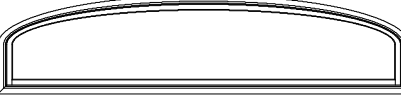
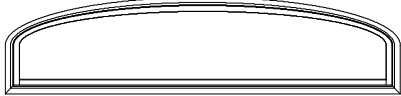
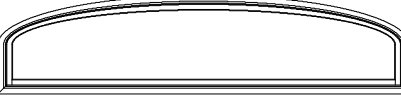
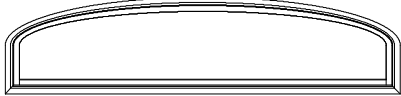
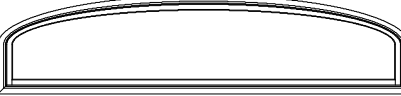
ELLIPSE UNITS

UNIT SIZE	38 3/4" (984)	42 3/4" (1086)	50 3/4" (1289)	58 3/4" (1492)			
ROUGH OPENING	36 3/4" (933)	40 3/4" (1035)	48 3/4" (1238)	56 3/4" (1441)			
FRAME SIZE	36" (914)	40" (1016)	48" (1219)	56" (1422)			
DAYLIGHT OPENING	31 1/2" (800)	35 1/2" (902)	43 1/2" (1105)	51 1/2" (1308)			
17 15/16" (455) 15 15/16" (405) 15 3/16" (386) 10 11/16" (271)		18 3/8" (467) 16 3/8" (416) 15 5/8" (397) 11 1/8" (283)		19 3/16" (487) 17 3/16" (437) 16 7/16" (418) 11 15/16" (303)		20" (508) 18" (457) 17 1/4" (438) 12 3/4" (324)	
UNIT SIZE	62 3/4" (1594)	66 3/4" (1695)	74 3/4" (1899)				
ROUGH OPENING	60 3/4" (1543)	64 3/4" (1645)	72 3/4" (1848)				
FRAME SIZE	60" (1524)	64" (1626)	72" (1829)				
DAYLIGHT OPENING	55 1/2" (1410)	59 1/2" (1511)	67 1/2" (1715)				
20 7/16" (519) 18 7/16" (468) 17 11/16" (449) 13 3/16" (335)		20 7/8" (530) 18 7/8" (479) 18 1/8" (460) 13 5/8" (346)		21 11/16" (525) 19 11/16" (500) 18 15/16" (481) 14 7/16" (367)			
UNIT SIZE	86 3/4" (2203)	92 3/4" (2356)					
ROUGH OPENING	84 3/4" (2153)	90 3/4" (2305)					
FRAME SIZE	84" (2134)	90" (2286)					
DAYLIGHT OPENING	79 1/2" (2019)	85 1/2" (2172)					
22 15/16" (583) 20 15/16" (532) 20 3/16" (513) 15 11/16" (398)		23 9/16" (598) 21 9/16" (547) 20 13/16" (529) 16 5/16" (414)					
UNIT SIZE	98 3/4" (2508)	102 3/4" (2610)					
ROUGH OPENING	96 3/4" (2457)	100 3/4" (2559)					
FRAME SIZE	96" (2438)	100" (2540)					
DAYLIGHT OPENING	91 1/2" (2324)	95 1/2" (2426)					
24 3/16" (614) 22 3/16" (564) 21 7/16" (545) 16 15/16" (430)		24 9/16" (624) 22 9/16" (573) 21 13/16" (554) 17 5/16" (440)					
UNIT SIZE	110 3/4" (2813)	122 3/4" (3118)					
ROUGH OPENING	108 3/4" (2762)	120 3/4" (3067)					
FRAME SIZE	108" (2743)	120" (3048)					
DAYLIGHT OPENING	103 1/2" (2629)	115 1/2" (2934)					
24 3/16" (614) 22 3/16" (564) 21 7/16" (545) 16 15/16" (430)		24 9/16" (624) 22 9/16" (573) 21 13/16" (554) 17 5/16" (440)					
UNIT SIZE	110 3/4" (2813)	122 3/4" (3118)					
ROUGH OPENING	108 3/4" (2762)	120 3/4" (3067)					
FRAME SIZE	108" (2743)	120" (3048)					
DAYLIGHT OPENING	103 1/2" (2629)	115 1/2" (2934)					
24 3/16" (614) 22 3/16" (564) 21 7/16" (545) 16 15/16" (430)		24 9/16" (624) 22 9/16" (573) 21 13/16" (554) 17 5/16" (440)					
UNIT SIZE	126 3/4" (3219)	138 3/4" (3514)					
ROUGH OPENING	124 3/4" (3168)	136 3/4" (3463)					
FRAME SIZE	124" (3149)	136" (3444)					
DAYLIGHT OPENING	119 1/2" (3035)	131 1/2" (3381)					
26 5/8" (676) 24 5/8" (625) 23 7/8" (607) 19 3/8" (492)		26 5/8" (676) 24 5/8" (625) 23 7/8" (607) 19 3/8" (492)					

ELEVATION SYMBOL LEGEND:
VALUES IN () ARE IN MILLIMETER CONVERSIONS.

SCALE: 1/4" = 1'

GLAZING OPTIONS

INTERIOR GLAZING OPTIONS

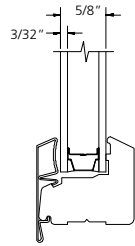

**CASEMENT
SS//SS**

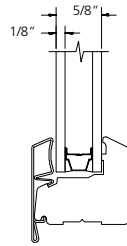

**CASEMENT
DS//DS**

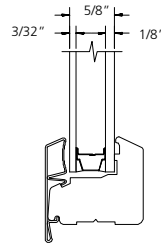

**CASEMENT
CA URBAN FIRE CODE**

TRIM OPTIONS

EXTERIOR TRIM

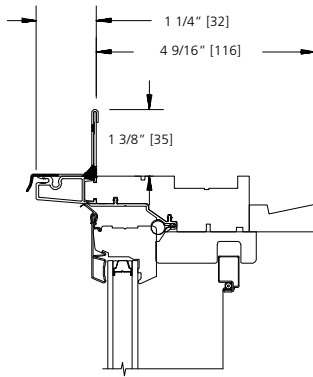

STANDARD

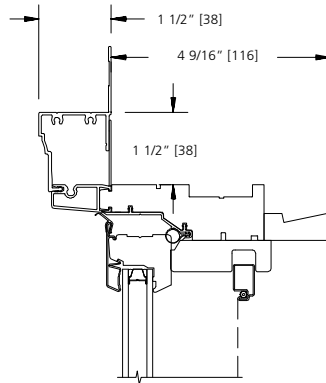

BRICKMOULD

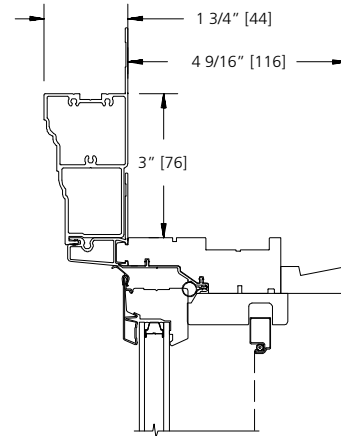

ADAMS CASING

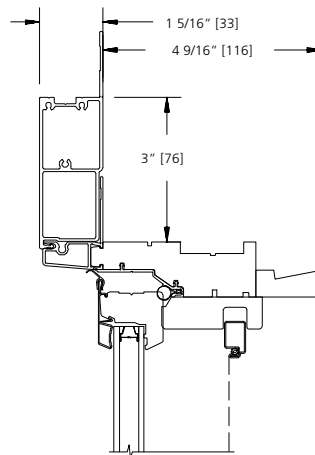

3 1/2" FLAT CASING

SILL NOSE OPTIONS

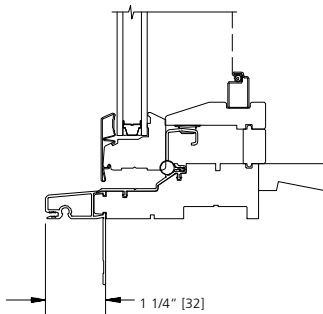

SILL OPTION WITH NAIL FIN

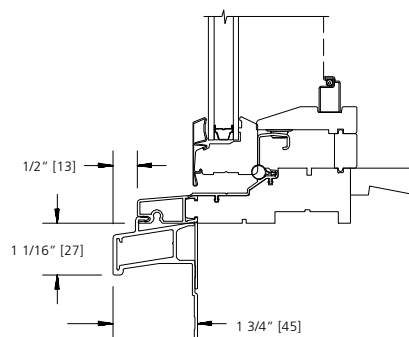

SILL OPTION WITH CASING

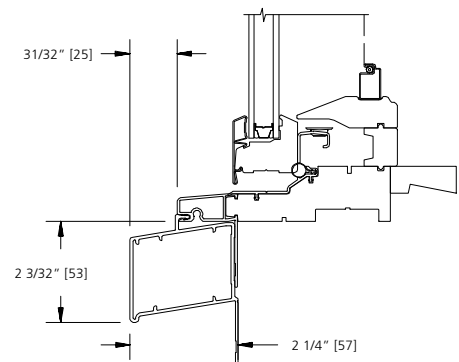

SILL WITH 2" SILL NOSE CASING

JAMB EXTENDER OPTIONS

JAMB EXTENDER OPTIONS

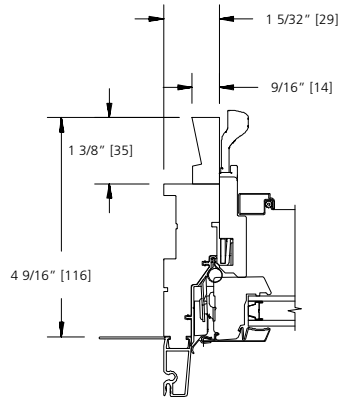

4 9/16" WALL

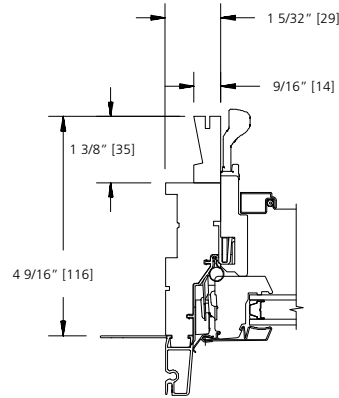

**4 9/16" WALL
WITH 9/16" KERF OPTION**

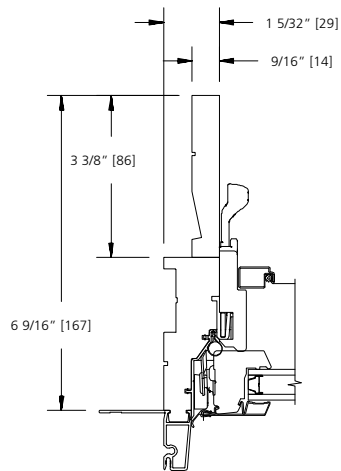

6 9/16" WALL

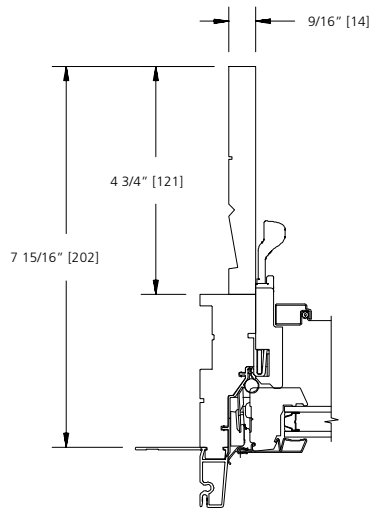

**7 15/16" WALL
MAX 1-PC
JAMB EXTENDER**

STANDARD MULLION OPTIONS

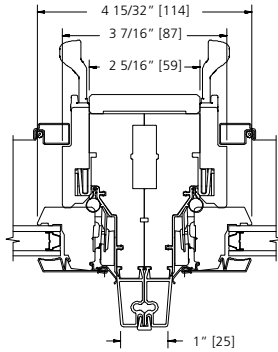

TWIN OPERATING CASEMENT

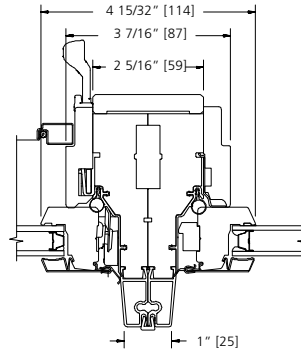

OPERATING CASEMENT WITH STATIONARY CASEMENT

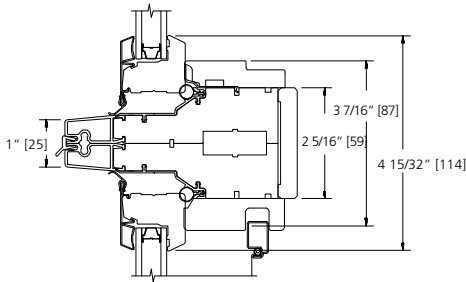

OPERATING CASEMENT WITH STATIONARY CASEMENT

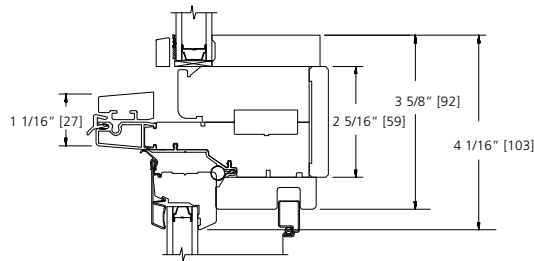

RAIDUS OVER CASEMENT

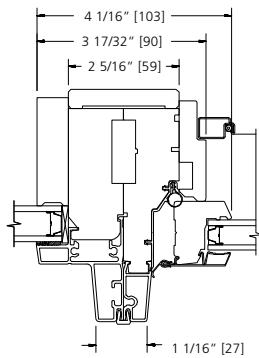

DIRECT SET PICTURE NEXT TO CASEMENT AND/OR DIRECT SET GEO OVER CASEMENT

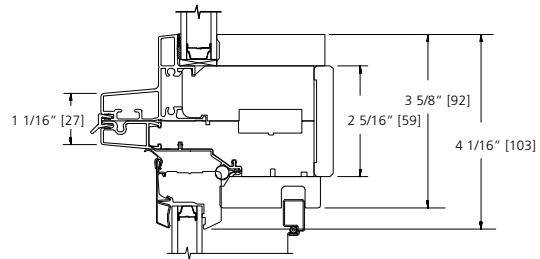

DIRECT SET PICTURE OVER CASEMENT AND/OR DIRECT SET GEO OVER CASEMENT

LITE CUT INFORMATION

Clad casement windows are available with 7/8" removable grilles, 7/8" beaded SDL, 5/8" flat GBG, or 23/32" contour GBG. Standard lite cuts are rectangular.

LITE CUT OPTIONS

Special lite cut patterns can include a wide variety of straight line and radius patterns. The illustrations shown here represent just a few of the possibilities. Rectangular, horizontal, vertical and Prairie lite patterns are available in all standard size clad casement windows. Uneven, diamond, radius and Gothic lite cuts are available, subject to approval. Approvals are based on the ability to fulfill the design requirement while maintaining the construction integrity of the finished product.

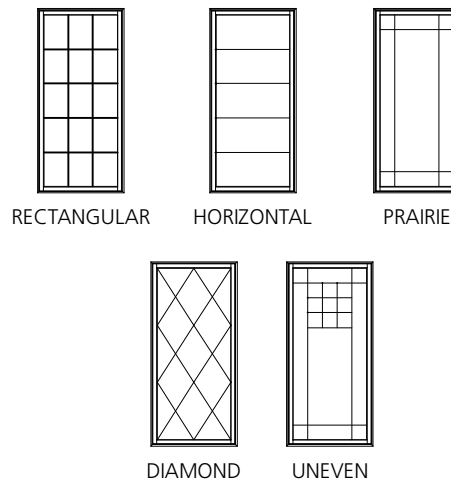

BAR ALIGNMENT

Alignment of divided lite muntin bars from one window to the next is often required by fine architectural design. Wood grilles, Grilles Between the Glass, grilles, and Simulated Divided Lites may be specified with muntin bars aligned.

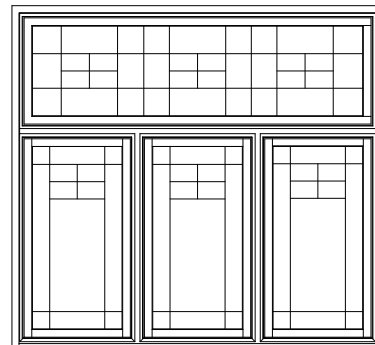

DIVIDED LITE OPTIONS

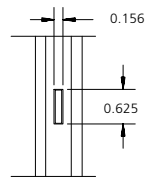

5/8" GRILLE

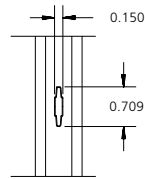

23/32" GRILLE

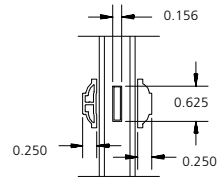

7/8" SDL

**UNIT SIZING, ROUGH OPENINGS
& MASONRY OPENINGS**

STANDARD OFFERING

DRIP CAP

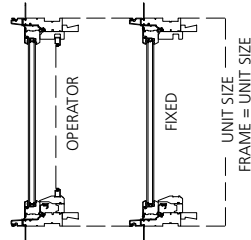
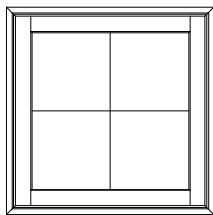
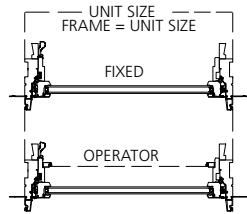

GENERAL NOTES:

UNITS WITH NO TRIM AND SILL NOSE:
UNIT SIZE = FRAME SIZE

UNIT SIZE IS ALWAYS THE
EXTREME SIZE OF THE WINDOW
WITH OR WITHOUT TRIM
(DRIP CAP & NAILING FLANGE ARE
NOT ADDED TO ANY UNIT SIZING)

MASONRY OPENING:
MASONRY OPENING IS ALWAYS 1/2" OVER
THE UNIT SIZE OF THE WINDOW

ROUGH OPENING:

ROUGH OPENING IS ALWAYS 3/4" OVER
FRAME SIZE OF THE WINDOW

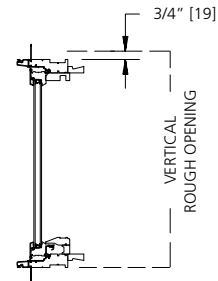
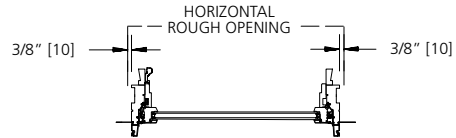

NON-STANDARD UNIT SIZING

EXTERIOR TRIM OFFERINGS

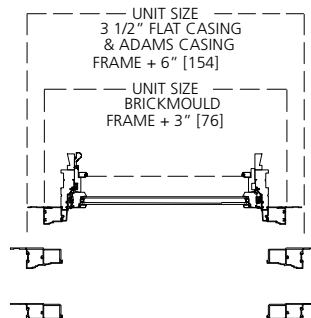
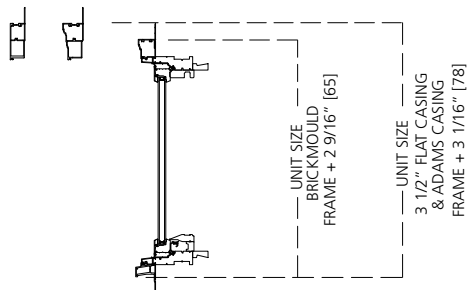

**FRAME TO TRIM
DIMENSIONS**

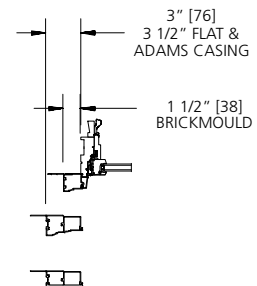

TYPICAL FOR HEAD AND SIDE

CASEMENT UNITS

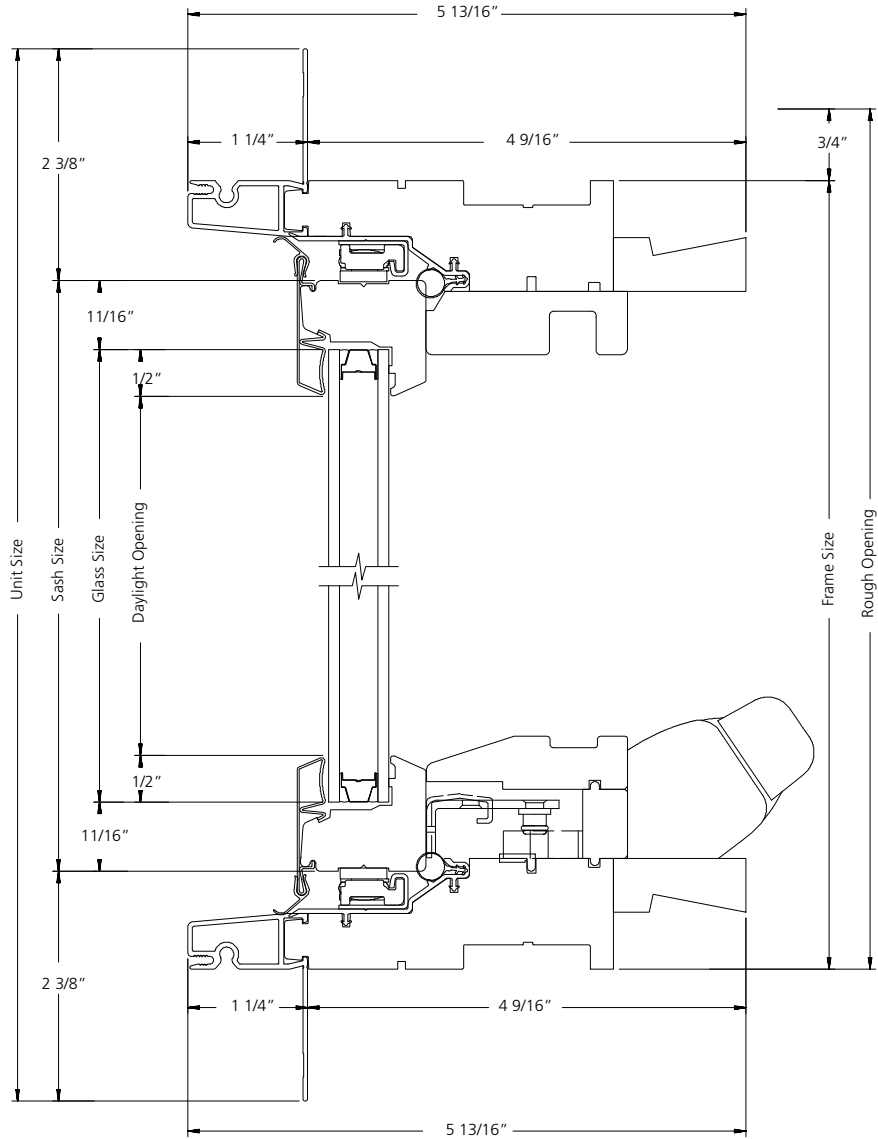

VERTICAL SECTION

SCALE: 6" = 1'

CASEMENT UNITS

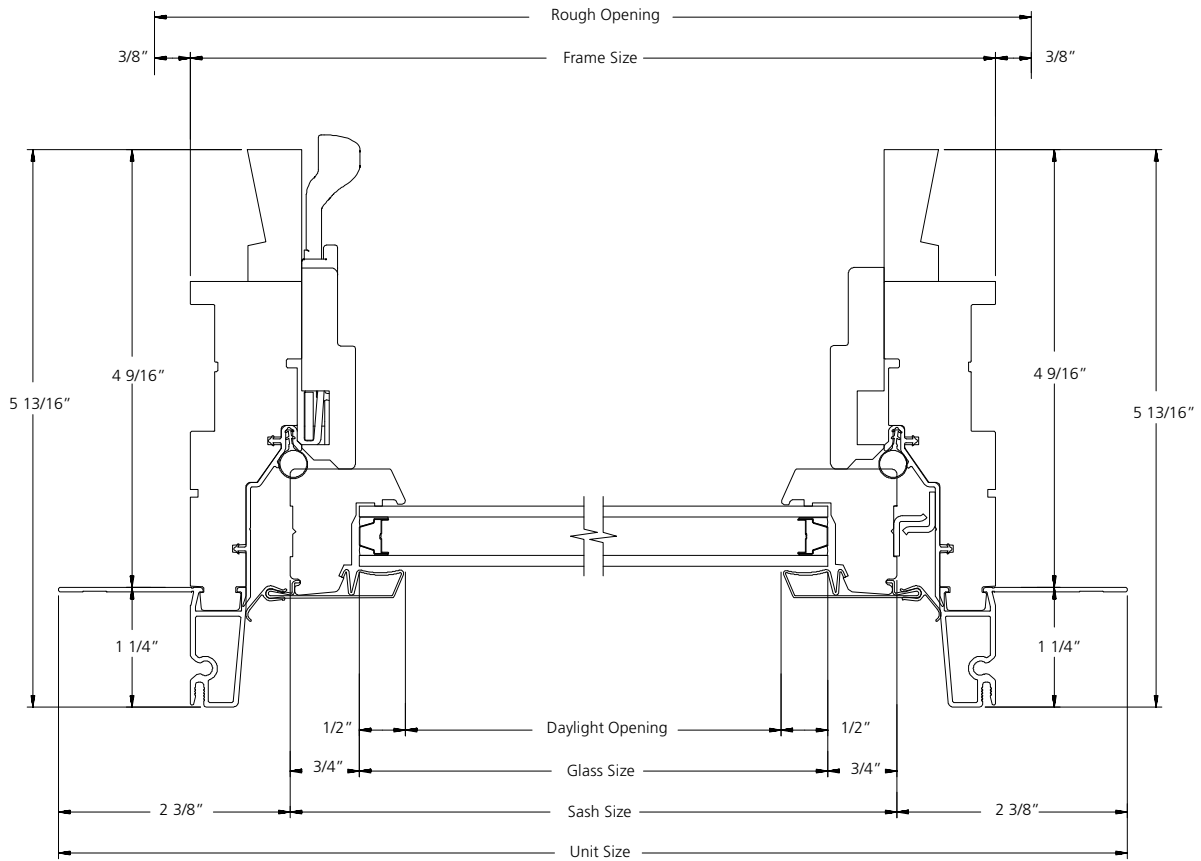

HORIZONTAL SECTION

SCALE: 6" = 1'

CASEMENT UNITS - MULL

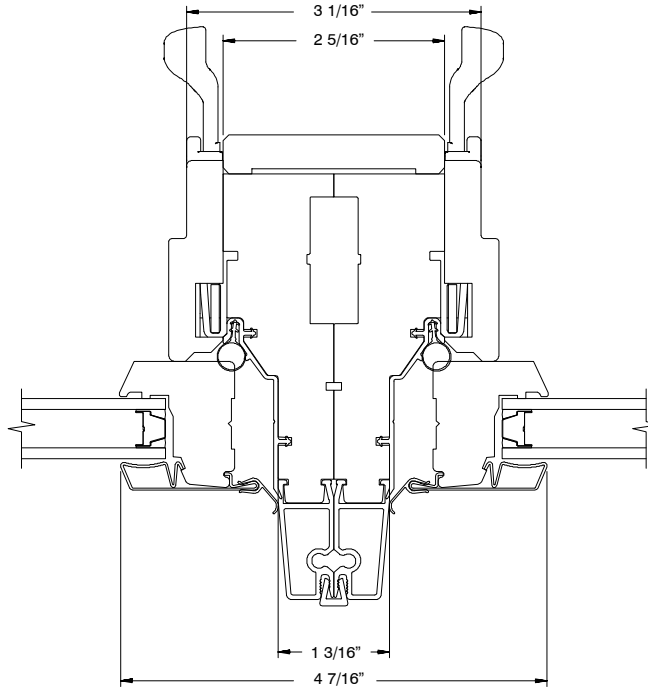

HORIZONTAL SECTION

TRANSOM

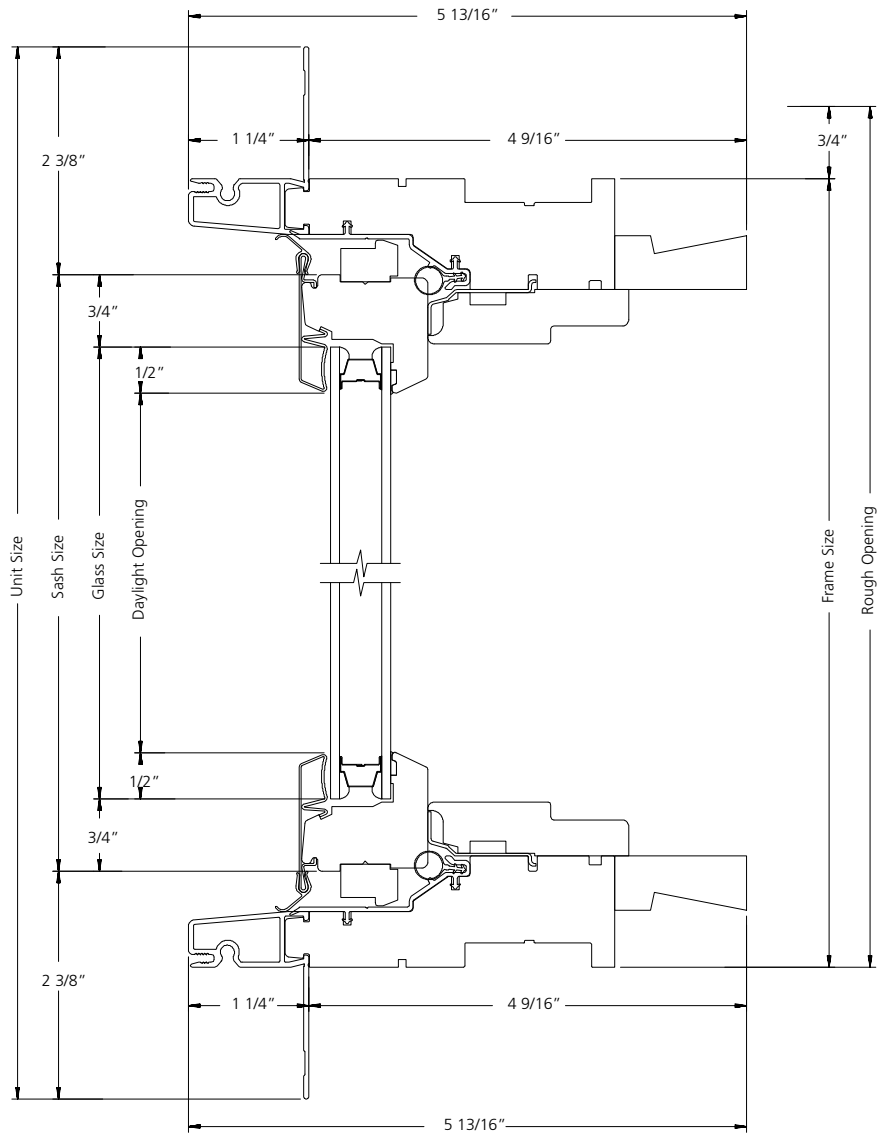

VERTICAL SECTION

SCALE: 6" = 1'

TRANSOM

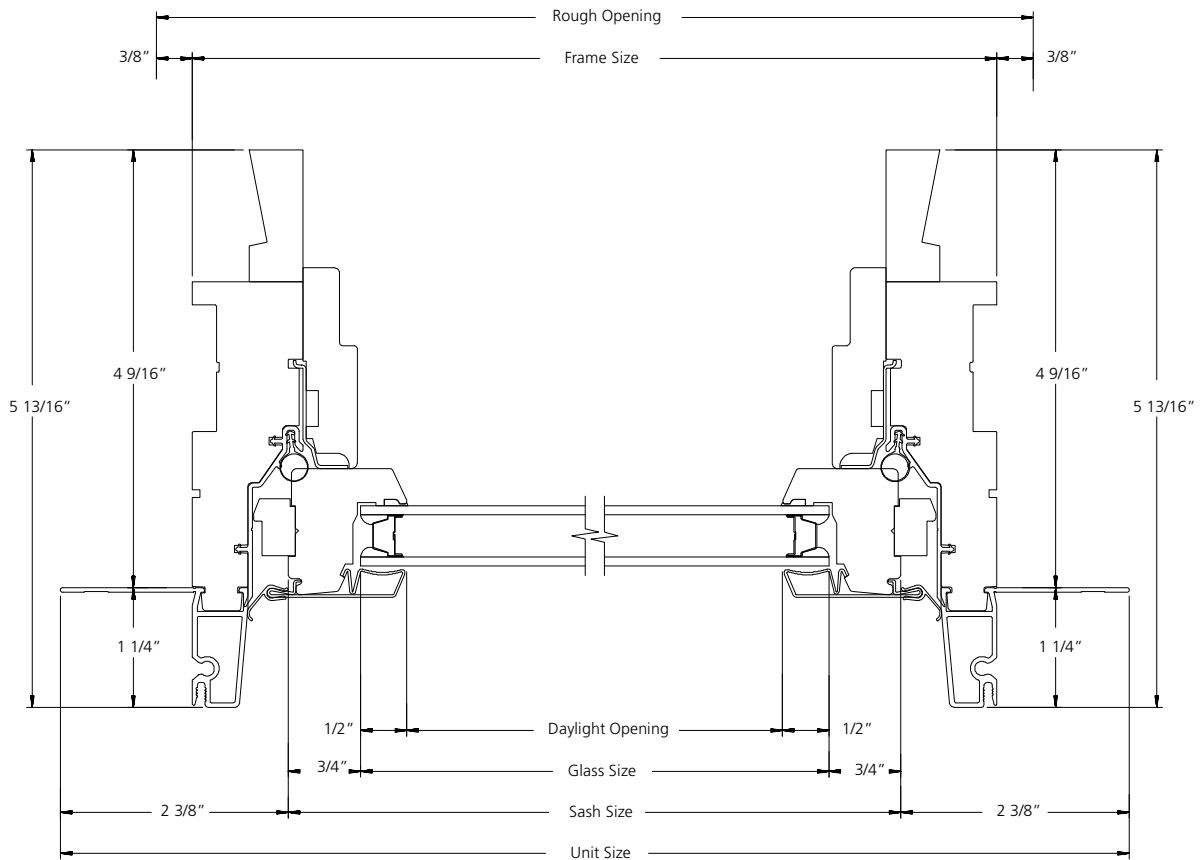

HORIZONTAL SECTION

SCALE: 6" = 1'

TRANSOM - MULL

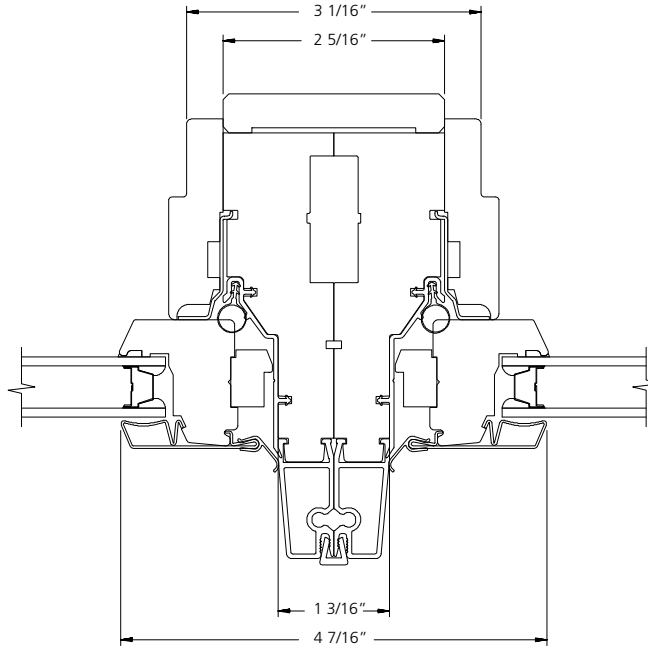

HORIZONTAL SECTION

SCALE: 6" = 1'

**CASEMENT UNITS
w/TRADITION PLUS SASH**

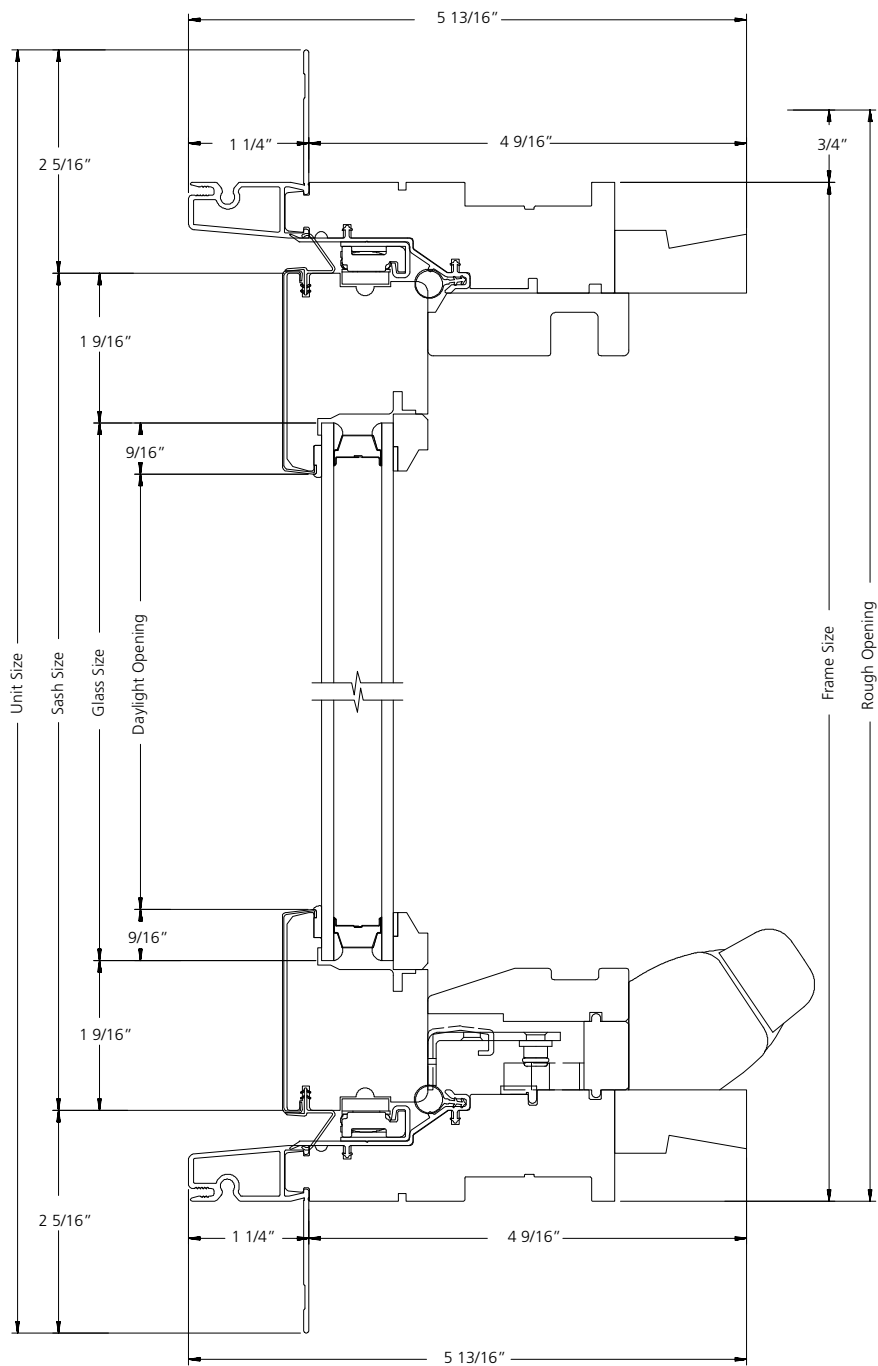

VERTICAL SECTION

SCALE: 6" = 1'

**CASEMENT UNITS
w/TRADITION PLUS SASH**

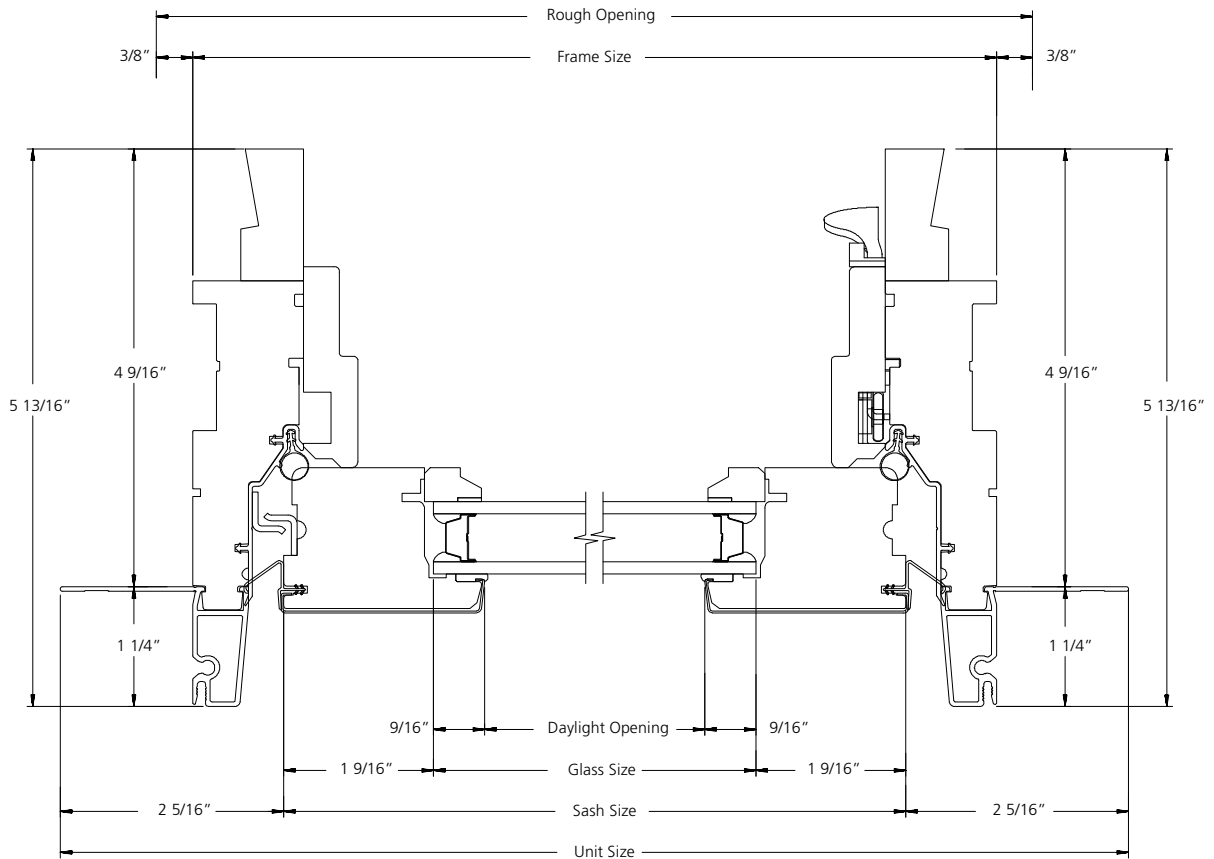

HORIZONTAL SECTION

SCALE: 6" = 1'

**CASEMENT PICTURE UNITS
w/TRADITION PLUS SASH**

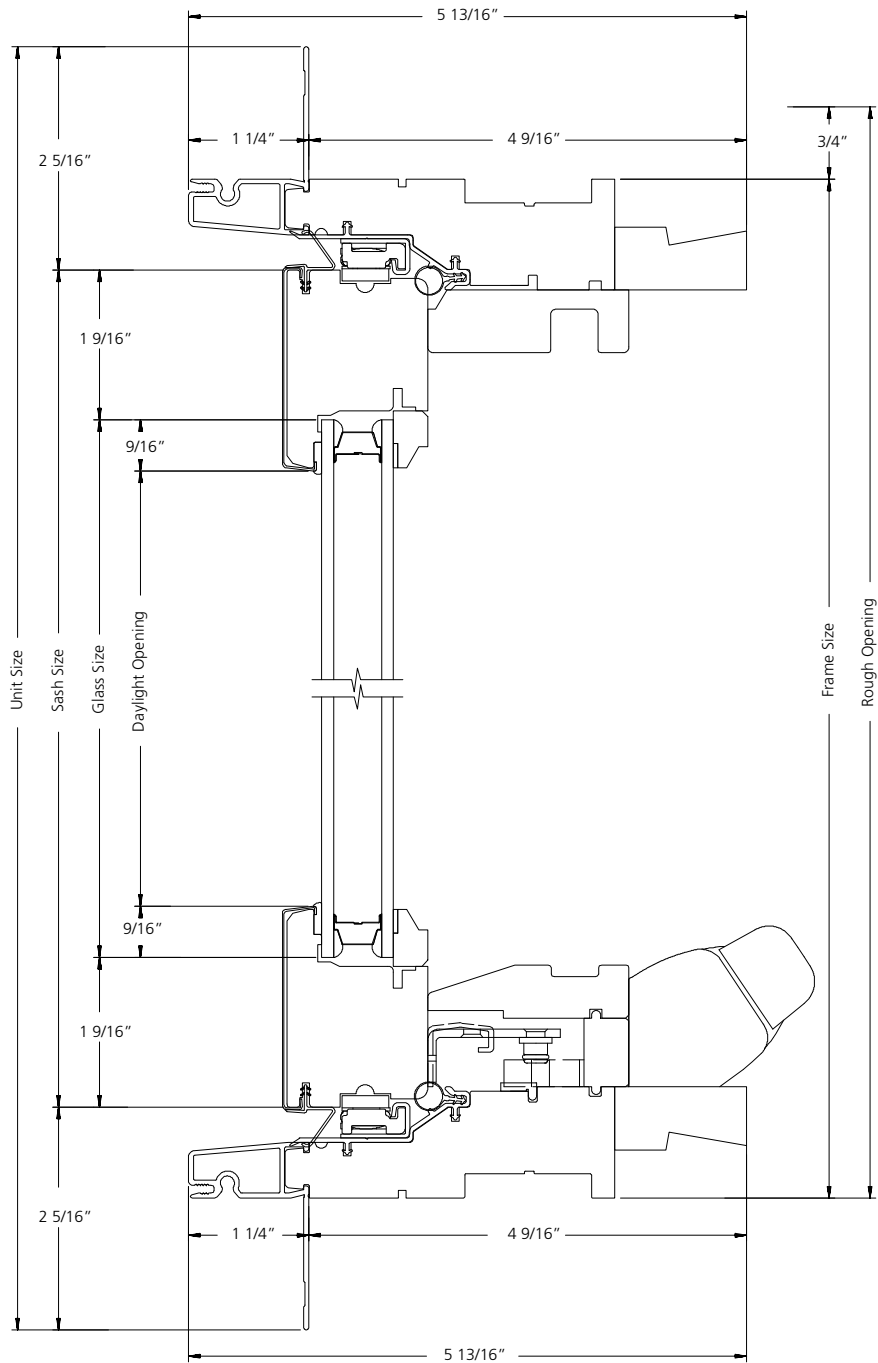

VERTICAL SECTION

SCALE: 6" = 1'

**CASEMENT PICTURE UNITS
w/TRADITION PLUS SASH**

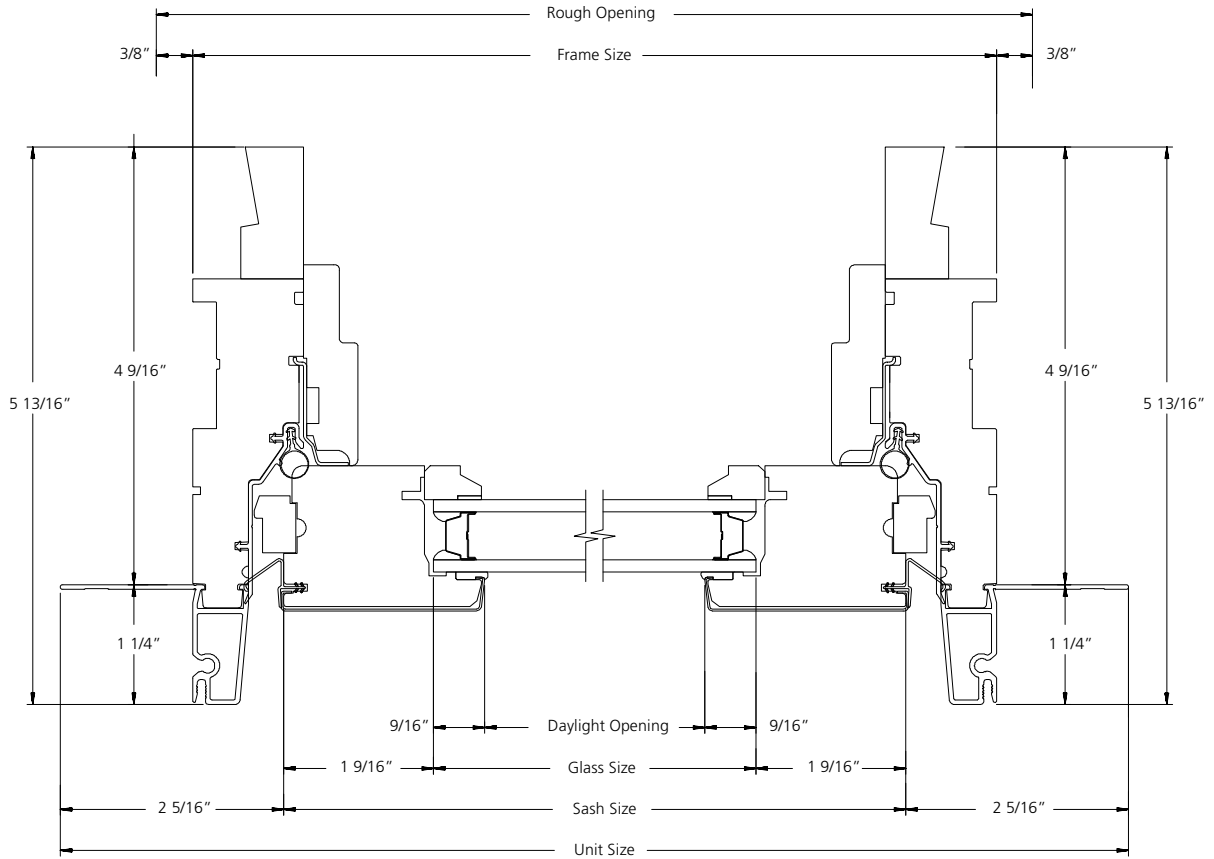

HORIZONTAL SECTION

SCALE: 6" = 1'