TABLE OF CONTENTS

Specifications	24-2
Quick Spec Guide	24-4
Elevations/Sizes: 1/8" Scale	24-6
Swinging Door Units	24-8
French Units	24-11
Single Door with Single Sidelite	24-13
Single Door with Two Sidelites	24-14
French Door with Two Sidelites	24-15
Transom Units	24-19
Sector Top Doors	24-24
French Sector Top Doors	24-26
French Sector Top Doors with Two Sidelites	24-28
Sector Top Transom Units	24-32
Glazing Options	24-33
Trim Options	24-37
Rail, Panel & Sill Options	24-38
Mullion Details	24-42
Grille & SDL Patterns	24-43
Unit Sizing, Rough Openings & Masonry Openings	24-44
Section Details: 3" Scale	24-45

PRODUCT SPECIFICATIONS**EXTERIOR FINISH**

The standard exterior is factory-applied latex primer with an option for unfinished (stain grade) natural pine exterior available.

AURALAST® WOOD

AuraLast® wood is fundamentally different from wood treated in traditional millwork preservation processes in that it uses a proprietary vacuum/pressure process to provide protection throughout the wood parts used to make windows and doors. AuraLast® wood is distinguished from wood using traditional preservation methods by its unique ability to achieve greater penetration of the active ingredients into the wood parts, with a minimum treatment penetration of 92%.

INTERIOR FINISH

Interior surfaces are unfinished clear pine ready for on-site finishing. Optional prefinished pine interiors include four acrylic colors (Moderate White, Extra White, Natural Choice, Pure White), five stains (Wheat, Cherry, Fruitwood, Cordovan, Cider) and a clear lacquer topcoat. Primed interior is also available.

FRAME

Frame is assembled from select kiln-dried pine AuraLast® wood on all exterior parts. Standard jamb width is 4-9/16". Radius frames are produced in only three different radii: 90-9/32", 37-19/16", and 31-19/32".

PANELS

1-23/32" thick select kiln-dried pine AuraLast® wood. The top and bottom rails are formed from solid Western Pine veneers laminated to a kiln dried edge-and-end-glued core, while the stiles have the same veneer laminated to a Timberstrand core. The layout is 4-5/8" top rail and stiles, and a 6-5/8" bottom rail. Other door rail options include wide bottom rail, lock rail and raised panels.

GLAZING

Insulating glass is constructed from two panes of tempered glass, utilizing a continuous roll formed stainless steel spacer with dual seal sealant. A computer-controlled application of clear silicone is used to bed the exterior of the insulating glass into the panel. An acrylic sealant is used to bed the interior. All insulating glass units comply with the performance requirements of IGCC in accordance with either ASTM E774 or E2190.

GLAZING OPTIONS - TEMPERED

Tempered insulating glass available in Low-E with Argon, Low-E, Low-E 366, Clear, Neat Glass, Seedy Reamy, tinted, reflective, or obscure, or other specialty glass as specified. Preserve® film is a 0.003" thick polyethylene film with a low tack acrylic adhesive applied to the glass for protection during shipping and installation. Installations at 4,000 foot elevations and higher require a capillary tube to equalize environmental stress (otherwise known as High Altitude glazing). High altitude glazing does not allow the use of Argon as listed under glazing options.

WEATHER-STRIPPING

Engineered system with dual foam filled bulb seal compressed between the exterior of the panel and the frame in a continuous plane on all four sides.

SILL

The sill is a dark bronze anodized aluminum with oak interior trim. A vinyl fin-and-bulb bottom door sweep is applied. An optional handicapped sill with a maximum height of 1/2" is available to meet the standards set forth by the ADA for handicapped access.

HARDWARE

The door panels are mounted into the frame utilizing 4" x 4" heavy gauge solid brass hinges with stainless steel pins. Three hinges are used on 6-8 and 7-0 heights, and four hinges on all larger heights. Optional adjustable hinges are also available providing both vertical and horizontal adjustment. The standard finish for all hinges is Polished Brass, with optional finishes available in Antique Brass, Polished Chrome, Brushed Chrome, Oil-Rubbed Bronze, White Powder Coat, Black Powder Coat, and Satin Nickel. The standard locking system is a single point mortise with lever handle, and thumb turn dead bolt, shipped separately for field installation. Matching dummy handle sets are included for French Door applications. Optional multipoint lock systems are factory installed securing the active panel at three points. The system is manually activated from the handle.

GRILLES

SDL (Simulated Divided Lites) - extruded aluminum muntins permanently applied to the exterior of the insulating glass unit (not available on textured glass) in 5/8", 7/8", 1-1/8", or 1-3/8" widths. Profiles are bead stop in all widths, and a putty profile in 5/8", 7/8", and 1-1/8" widths only. 1" Copper SDL is also available. SDL is standard with a light bronze internal shadow bar to give a true divided lite appearance. As an option, SDL may be ordered with a silver shadow bar. Clear wood interior muntin bars match the exterior muntin width and are permanently bonded to the interior of the glass. Also available is a 2-5/16" SDL bar, which simulates a double-hung checkrail.

PD (Precise Divided Lites) - Wood or extruded aluminum muntins permanently applied to the exterior of the insulating unit (not available on textured glass) in 3/4" and 1-1/2" widths or without a shadow bar. Clear wood interior muntin bars match the exterior muntin width and are permanently bonded to the interior of the glass.

Full-Surround Removable Wood Grilles - Rectangular, unfinished interior clear pine wood grilles in 7/8", 1-1/8", and 1-3/8" are available in patterns selected by the owner.

GBG (Grilles between the Glass) - 5/8" flat, 23/32" contour, or 1" contour grilles mounted between the glass panes suspended within the air cavity.

EXTERIOR TRIM

Brickmould standard with optional 3-1/2", 4-1/2", 5-1/2" flat trim, 3-1/2" Adams and 1 x 4 Backband trim. Optional mull covers to accommodate 1" (spread only), 2", 3-1/2" and 6" spread and stud pocket mull.

EXTENSION JAMBS

Extension jambs are available for wall depths up to 6-9/16".

Continued on next page

PRODUCT SPECIFICATIONS

INSTALLATION

Installation per JELD-WEN Installation Method for Wood Patio Doors.
See www.jeld-wen.com/resources for instructions.

PERFORMANCE

ANSI/AAMA/NWDA/101/I.S.2-97
AMMA/WDMA/CSA 101/I.S.2/A440-05
WDMA Hallmark Certified

See www.jeld-wen.com for architectural and performance information.

QUICK SPEC GUIDE

SPECIFICATION	STANDARD FEATURES	OPTIONAL FEATURES <i>Some options may require additional lead times. Consult your JELD-WEN Sales Representative.</i>
EXTERIOR FINISH	<ul style="list-style-type: none"> • Primed 	<ul style="list-style-type: none"> • Natural • Vertical Grain Douglas Fir • Mahogany
		Panel Only: <ul style="list-style-type: none"> • Natural Copper* <i>*Copper is only available when ordered with a clad panel</i> • Speckled Patina Copper • Hand Rubbed Copper
EXTERIOR TRIM	<ul style="list-style-type: none"> • Brickmould & Subsill 	<ul style="list-style-type: none"> • Adams Casing • 3-1/2" Flat Casing • 4-1/2" Flat Casing • 5-1/2" Flat Casing
INTERIOR WOOD	<ul style="list-style-type: none"> • Western Pine 	<ul style="list-style-type: none"> • Vertical Grain Douglas Fir • Mahogany
INTERIOR FINISH	<ul style="list-style-type: none"> • Natural 	<ul style="list-style-type: none"> • Priming Available Pre-finished Interior Options are: <ul style="list-style-type: none"> • Paint - Pure White, Extra White, Natural Choice, Moderate White • Stain - Wheat, Fruitwood, Cherry, Cordovan, Cider • Clear Lacquer
SIZE	<ul style="list-style-type: none"> • Width: 2-0, 2-6, 2-8, 3-0, 3-6, 5-0, 5-4, 6-0, 7-6, 8-0, 9-0 • Height: 6-8, 7-0, 8-0, 9-0 	<ul style="list-style-type: none"> • Any Panel Width: 2-0 to 3-6 (Certain restrictions apply) • Any Panel Height: 4-0 to 10-0 (Certain restrictions apply)
GLAZING (ALL TEMPERED)	<ul style="list-style-type: none"> • Low-E Tempered Insulating Glass (with Argon) • Low-E 366 • Preserve® Protective Film 	<ul style="list-style-type: none"> • Clear • Obscure • Tints: Bronze, Gray, Green • Reflective • Neat Glass • Seedy Reamy • Glue Chip • Rain • Narrow Reed • Sandblasted • Tempered • Impact Resistant
		<ul style="list-style-type: none"> • High Altitude (Breather Tube, no Argon)
GRILLES		SDL Bead Profile: <ul style="list-style-type: none"> • 5/8", 7/8", 1-1/8", 1-3/8", 2-5/16" with Light Bronze Shadow Bar • 5/8", 7/8", 1-1/8", 1-3/8", 2-5/16" with Silver Shadow Bar SDL Putty Profile: <ul style="list-style-type: none"> • 5/8", 7/8" and 1-1/8" with Light Bronze Shadow Bar • 5/8", 7/8" and 1-1/8" with Silver Shadow Bar <ul style="list-style-type: none"> • 1" Copper SDL PDL: <ul style="list-style-type: none"> • 3/4" or 1-1/2" Precise Divided Lite GBG (Grilles between the Glass): <ul style="list-style-type: none"> • 5/8" Flat, 23/32" Contour, 1" Contour GBG Full-Surround: <ul style="list-style-type: none"> • 7/8", 1-1/8", 1-3/8"
HARDWARE	<ul style="list-style-type: none"> • 4 x 4 Heavy Gauge Hinges • Single Point Mortise Lock with Lever Handle 	<ul style="list-style-type: none"> • Adjustable Hinges • Multipoint Manually Activated Lock

Continued on next page

QUICK SPEC GUIDE

SPECIFICATION	STANDARD FEATURES	OPTIONAL FEATURES <i>Some options may require additional lead times. Consult your JELD-WEN Sales Representative.</i>
HARDWARE COLOR	<ul style="list-style-type: none"> • Polished Brass 	<ul style="list-style-type: none"> • Antique Brass • Polished Chrome • Brushed Chrome <ul style="list-style-type: none"> • Oil-Rubbed Bronze • White Powder Coat • Black Powder Coat
JAMB	<ul style="list-style-type: none"> • Applied, 5/4 • 4-9/16" 	<ul style="list-style-type: none"> • Up to 6-9/16"

GENERAL INFORMATION

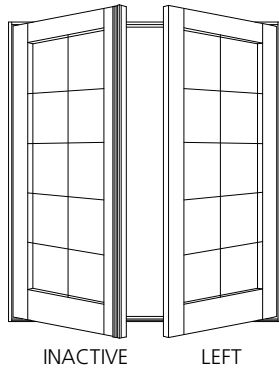

DIMENSIONAL DOORS

Wood out-swing patio doors may be specified as "dimensional" by adjusting the desired rough opening width or height in 1/4" increments from standard.

Wood out-swing patio doors are available in single, twin, triple and quad panel doors. Transoms are available to match the variety of door sizes. The standard size range includes sizes specifically designed for replacement of older patio door models in existing structures, as well as a full range of "true size" products for architectural consistency.

OPERATION

Wood out-swing patio doors are available in a full range of operating styles. Single panel doors may be specified as stationary (non-venting) or can operate left or right. Center swing two- or three-panel doors are available with left or right operation. French doors feature two operating panels (one active, which opens first; and one inactive, which closes first), and are available in two-panel and four panel styles. Configuration and handing is based on viewing the door from the exterior.

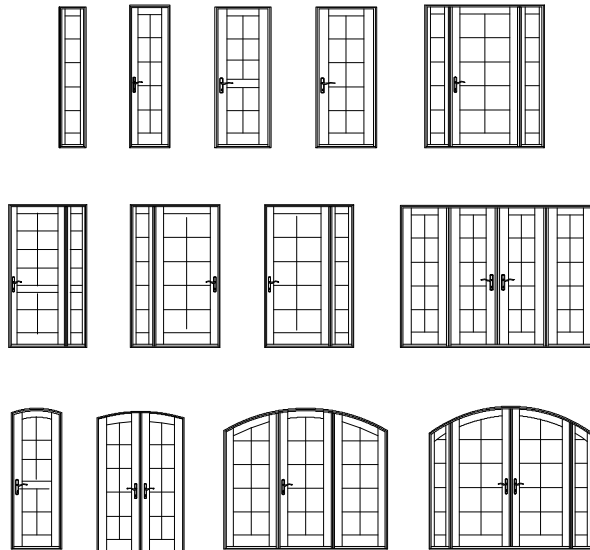

MULTIPLE ASSEMBLIES

Wood out-swing patio doors are available in a wide variety of multiple panel configurations from the factory, all of which are assembled with continuous sills. Wood out-swing patio doors may be mulled below or beside other wood door and wood window products. Factory assembled mulls are limited in height (100"), width (150"), and a total area (75 square feet).



ELEVATION NOTES

ELEVATION DRAWINGS UTILIZE A LIMITED NUMBER OF PROJECTED LINES TO PRODUCE A RUDIMENTARY DRAWING INTENDED TO BE USED IN A SMALL GRAPHICAL SCALE. ELEVATIONS ARE VIEWED PERPENDICULAR FROM THE EXTERIOR OF THE STRUCTURE. IF MORE DIMENSIONS ARE NEEDED, USE THE SECTION DRAWINGS FOR MORE COMPLETE DEPICTIONS.

M.O. Brickmould	41 3/16" [1046]	<p>Masonry Openings for Brickmould, Flat & Adams Casing. Vertical measurements for transoms include Brickmould at the sill. (Subtract 1/2" from Masonry Opening for Unit Size)</p>
M.O. Adams/Flat Casing	44 1/4" [1124]	
Rough Opening	38 3/16" [970]	
Frame Size	37 7/16" [951]	
Daylight Opening	26 5/8" [676]	

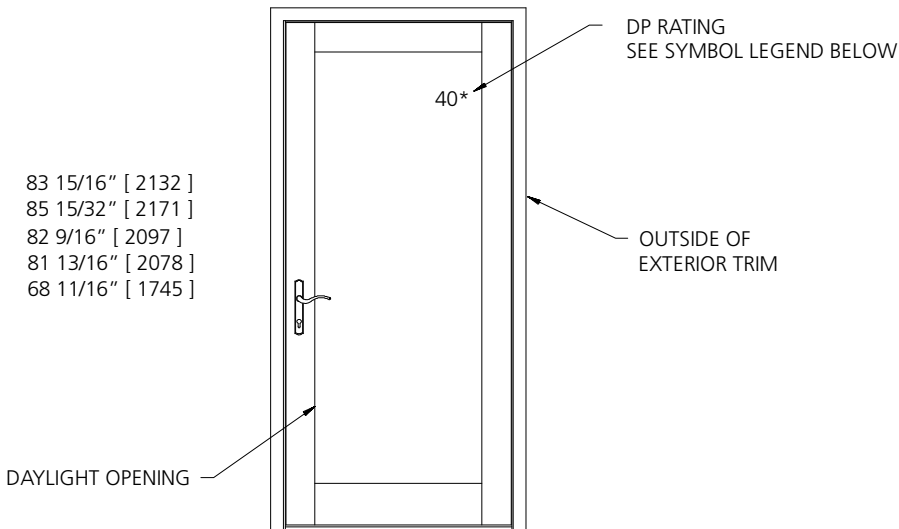

WOSWT3068

'WOSW' INDICATES WOOD OUT-SWING PATIO DOOR
'WOFR' INDICATES WOOD OUT-SWING FRENCH DOOR
'T' INDICATES 'TRUE SIZE'
'R' INDICATES 'RETRO SIZE'

BOOK CODE
THE LAST TWO NUMBERS INDICATE THE UNIT HEIGHT
THE FIRST TWO NUMBERS INDICATE THE UNIT WIDTH

GENERAL SWINGING DOOR NOTES

1. WOOD OUT-SWING PATIO DOOR (WOSW) UNITS ARE AVAILABLE AS OPERATING OR STATIONARY UNITS.
2. UNIT ELEVATIONS ARE SHOWN WITH BRICKMOULD. TRANSOM UNITS ARE SHOWN WITH BRICKMOULD ON ALL SIDES.
3. OPERATING UNITS ARE AVAILABLE AS LEFT OR RIGHT HAND OPERATION.
4. HANDICAP SILL, 10 1/4" BOTTOM RAILS AND INTERMEDIATE LOCK RAILS ARE AVAILABLE FOR ALL UNITS.

ELEVATION SYMBOL LEGEND:

- S** PANEL IS AVAILABLE AS STATIONARY ONLY.
- ##*** NUMBER INDICATES DESIGN PRESSURE (DP) RATING WITH STANDARD GLAZING. OPERATING UNITS UTILIZE MULTI-POINT LOCKING HARDWARE FOR DP RATINGS.

1-PANEL UNITS

M.O. BRICKMOUND
M.O. ADAMS/FLAT CASING
ROUGH OPENING
FRAME SIZE
DAYLIGHT OPENING

27 3/16" [691]
30 1/4" [768]
24 3/16" [614]
23 7/16" [595]
12 5/8" [321]

33 3/16" [843]
36 1/4" [921]
30 3/16" [767]
29 7/16" [748]
18 5/8" [473]

35 3/16" [894]
38 1/4" [972]
32 3/16" [817]
31 7/16" [799]
20 5/8" [524]

39 3/16" [995]
42 1/4" [1073]
36 3/16" [919]
35 7/16" [900]
24 5/8" [625]

80 15/16" [2056]
82 15/32" [2095]
79 9/16" [2021]
78 13/16" [2002]
65 11/16" [1668]

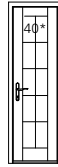

WOSWR2068

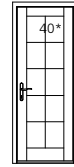

WOSWR2668

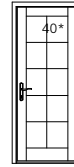

WOSWR2868

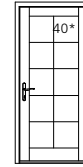

WOSWR3068

96 15/16" [2462]
98 15/32" [2501]
95 9/16" [2427]
94 13/16" [2408]
81 11/16" [2075]

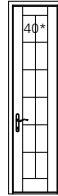

WOSWR2080

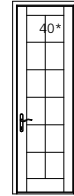

WOSWR2680

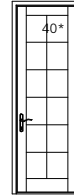

WOSWR2880

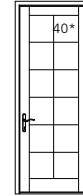

WOSWR3080

108 15/16" [2767]
110 15/32" [2806]
107 9/16" [2732]
106 13/16" [2713]
93 11/16" [2380]

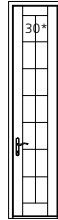

WOSWR2090

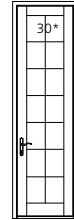

WOSWR2690

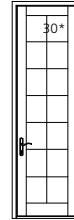

WOSWR2890

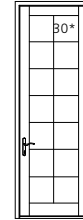

WOSWR3090

ELEVATION SYMBOL LEGEND:

M.O. = MASONRY OPENING
VALUES IN [] ARE IN MILLIMETER CONVERSIONS.
S PANEL IS AVAILABLE AS STATIONARY ONLY.

NUMBER INDICATES DESIGN PRESSURE (DP) RATING WITH STANDARD GLAZING. OPERATING UNITS UTILIZE MULTI-POINT LOCKING HARDWARE FOR DP RATINGS.

Note: Elevations shown DO NOT have exterior trim.
Subtract 1/2" (12.7) from M.O. (Masonry Opening) for Unit Size. For other Trim Options refer to the Unit Sizing, Rough Opening & Masonry Openings page.

M.O. BRICKMOUND
M.O. ADAMS/FLAT CASING
ROUGH OPENING
FRAME SIZE
DAYLIGHT OPENING

17 5/16" [440]
40 3/8" [518]
14 5/16" [363]
13 9/16" [344]
7 1/2" [190]

19 5/16" [491]
22 3/8" [568]
16 5/16" [414]
15 9/16" [395]
9 1/2" [241]

21 5/16" [541]
24 3/8" [619]
18 5/16" [465]
17 9/16" [446]
11 1/2" [292]

29 3/16" [741]
32 1/4" [819]
26 3/16" [665]
25 7/16" [646]
14 5/8" [371]

35 3/16" [894]
38 1/4" [972]
32 3/16" [817]
31 7/16" [799]
20 5/8" [524]

37 3/16" [945]
40 1/4" [1022]
34 3/16" [868]
33 7/16" [849]
22 5/8" [575]

41 3/16" [1046]
44 1/4" [1124]
38 3/16" [970]
37 7/16" [951]
26 5/8" [676]

47 3/16" [1199]
50 1/4" [1276]
44 3/16" [1121]
43 7/16" [1103]
32 5/8" [829]

83 15/16" [2132]
85 15/32" [2171]
82 9/16" [2097]
81 13/16" [2078]
68 11/16" [1778]



WOSWT1068



WOSWT1268



WOSWT1468

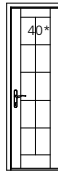

WOSWT2068

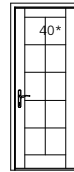

WOSWT2668

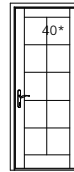

WOSWT2868

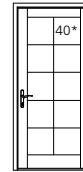

WOSWT3068

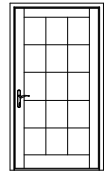

WOSWT3668

87 15/16" [2234]
89 15/32" [2273]
86 9/16" [2199]
85 13/16" [2180]
72 11/16" [1846]

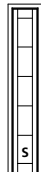

WOSWT1070



WOSWT1270



WOSWT1470

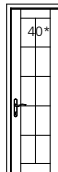

WOSWT2070

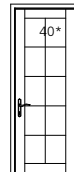

WOSWT2670

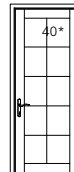

WOSWT2870

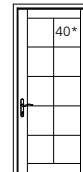

WOSWT3070

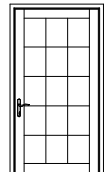

WOSWT3670

99 15/16" [2538]
101 15/32" [2577]
98 9/16" [2503]
97 13/16" [2484]
84 11/16" [2151]



WOSWT1080



WOSWT1280



WOSWT1480

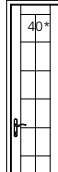

WOSWT2080

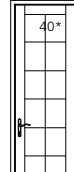

WOSWT2680

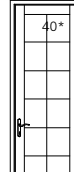

WOSWT2880

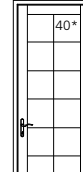

WOSWT3080

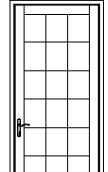

WOSWT3680

111 15/16" [2843]
113 15/32" [2882]
110 9/16" [2808]
109 13/16" [2789]
96 11/16" [2456]



WOSWT1090



WOSWT1290



WOSWT1490

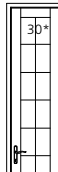

WOSWT2090

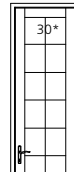

WOSWT2690

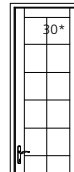

WOSWT2890

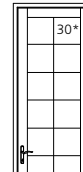

WOSWT3090

SCALE: 1/8" = 1'

2-PANEL UNITS

M.O. BRICKMOULD
M.O. ADAMS/FLAT CASING
ROUGH OPENING
FRAME SIZE
DAYLIGHT OPENING

62 3/8" [1584]
65 7/16" [1662]
59 3/8" [1508]
58 5/8" [1489]
18 5/8" [473] (2)

66 3/8" [1686]
69 7/16" [1764]
63 3/8" [1610]
62 5/8" [1591]
20 5/8" [524] (2)

74 3/8" [1889]
77 7/16" [1967]
71 3/8" [1813]
70 5/8" [1794]
24 5/8" [624] (2)

80 15/16" [2056]
82 15/32" [2095]
79 9/16" [2021]
78 13/16" [2002]
65 11/16" [1668]

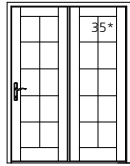

WOSWR5068

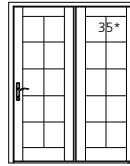

WOSWR5468

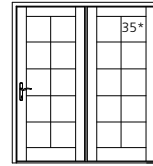

WOSWR6068

96 15/16" [2462]
96 15/32" [2501]
93 9/16" [2427]
94 13/16" [2408]
81 11/16" [2075]

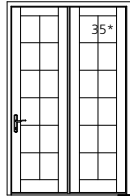

WOSWR5080

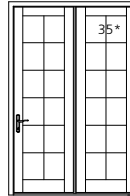

WOSWR5480

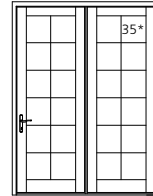

WOSWR6080

108 15/16" [2767]
110 15/32" [2806]
107 9/16" [2732]
106 13/16" [2713]
93 11/16" [2380]

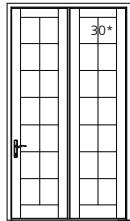

WOSWR5090

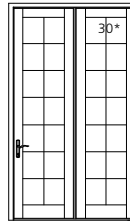

WOSWR5490

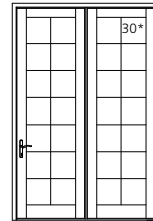

WOSWR6090

M.O. BRICKMOULD
M.O. ADAMS/FLAT CASING
ROUGH OPENING
FRAME SIZE
DAYLIGHT OPENING

66 3/8" [1686]
69 7/16" [1764]
63 3/8" [1610]
62 5/8" [1591]
20 5/8" [524] (2)

70 3/8" [1788]
73 7/16" [1865]
67 3/8" [1711]
66 5/8" [1692]
22 5/8" [575] (2)

78 3/8" [1991]
81 7/16" [2069]
75 3/8" [1914]
74 5/8" [1895]
26 5/8" [676] (2)

90 3/8" [2296]
93 7/16" [2373]
87 3/8" [2219]
86 5/8" [2200]
32 5/8" [829] (2)

83 15/16" [2132]
85 15/32" [2171]
82 9/16" [2097]
81 13/16" [2078]
68 11/16" [1745]

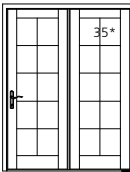

WOSWT5068

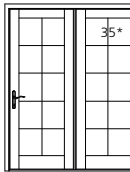

WOSWT5468

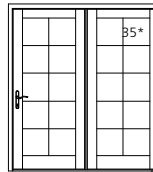

WOSWT6068

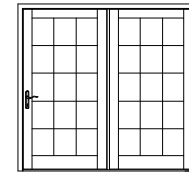

WOSWT7068

87 15/16" [2234]
89 15/32" [2273]
86 9/16" [2199]
85 13/16" [2180]
72 11/16" [1846]

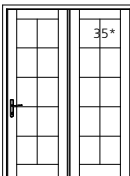

WOSWT5070

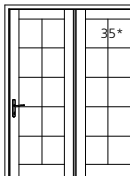

WOSWT5470

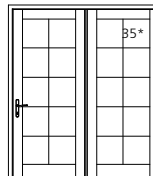

WOSWT6070

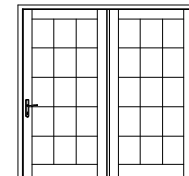

WOSWT7070

99 15/16" [2538]
101 15/32" [2577]
98 9/16" [2503]
97 13/16" [2484]
84 11/16" [2151]

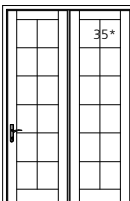

WOSWT5080

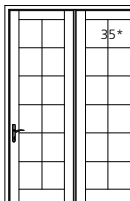

WOSWT5480

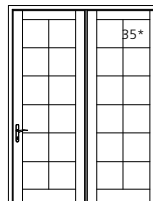

WOSWT6080

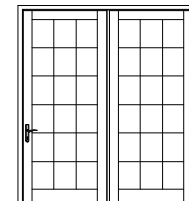

WOSWT7080

111 15/16" [2843]
113 15/32" [2882]
110 9/16" [2808]
109 13/16" [2789]
96 11/16" [2456]

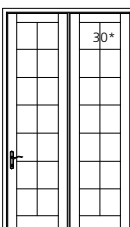

WOSWT5090

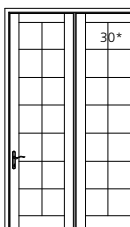

WOSWT5490

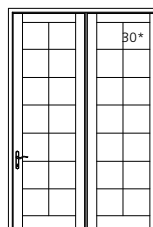

WOSWT6090

ELEVATION SYMBOL LEGEND:

M.O. = MASONRY OPENING
VALUES IN [] ARE IN MILLIMETER CONVERSIONS.
VALUES IN () ARE NUMBER OF DAYLIGHT OPENINGS PER UNIT.
*** NUMBER INDICATES DESIGN PRESSURE (DP) RATING
WITH STANDARD GLAZING. OPERATING UNITS UTILIZE
MULTI-POINT LOCKING HARDWARE FOR DP RATINGS.

Note: Elevations shown DO NOT have exterior trim.
Subtract 1/2" (12.7) from M.O. (Masonry
Opening) for Unit Size. For other Trim Options
refer to the Unit Sizing, Rough Opening &
Masonry Openings page.

SCALE: 1/8" = 1'

3-PANEL UNITS

M.O. BRICKMOULD
M.O. ADAMS/FLAT CASING
ROUGH OPENING
FRAME SIZE
DAYLIGHT OPENING

91 9/16" [2326]
94 5/8" [2403]
88 9/16" [2249]
87 13/16" [2230]
18 5/8" [473] (3)

97 9/16" [2478]
100 5/8" [2556]
94 9/16" [2402]
93 13/16" [2383]
20 5/8" [524] (3)

109 9/16" [2783]
112 5/8" [2861]
106 9/16" [2707]
105 13/16" [2688]
24 5/8" [625] (3)

80 15/16" [2056]
82 15/32" [2095]
79 9/16" [2021]
78 13/16" [2002]
65 11/16" [1668]

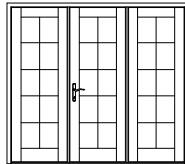

WOSWR7668

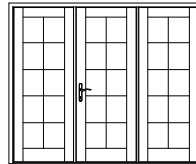

WOSWR8068

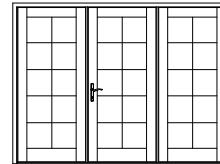

WOSWR9068

96 15/16" [2462]
98 15/32" [2501]
95 9/16" [2427]
94 13/16" [2408]
81 11/16" [2075]

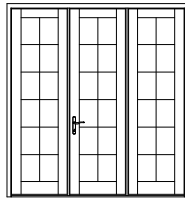

WOSWR7680

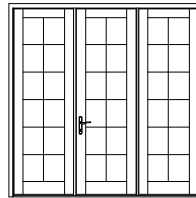

WOSWR8080

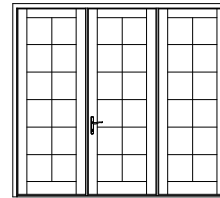

WOSWR9080

108 15/16" [2767]
110 15/32" [2806]
107 9/16" [2732]
106 13/16" [2713]
93 11/16" [2380]

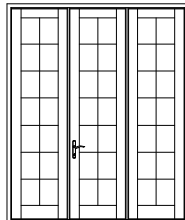

WOSWR7690

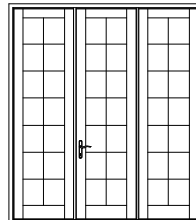

WOSWR8090

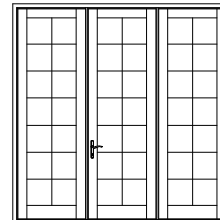

WOSWR9090

M.O. BRICKMOULD
M.O. ADAMS/FLAT CASING
ROUGH OPENING
FRAME SIZE
DAYLIGHT OPENING

97 9/16" [2478]
100 5/8" [2556]
94 9/16" [2402]
93 13/16" [2383]
20 5/8" [524] (3)

103 9/16" [2630]
106 5/8" [2708]
100 9/16" [2554]
99 13/16" [2535]
22 5/8" [575] (3)

115 9/16" [2935]
118 5/8" [3013]
112 9/16" [2859]
111 13/16" [2840]
26 5/8" [676] (3)

83 15/16" [2132]
85 15/32" [2171]
82 9/16" [2097]
81 13/16" [2078]
68 11/16" [1745]

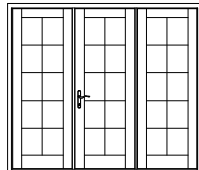

WOSWT7668

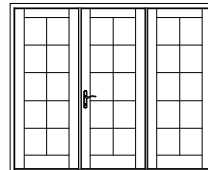

WOSWT8068

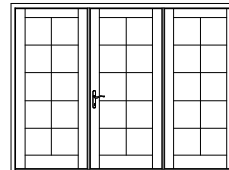

WOSWT9068

87 15/16" [2234]
89 15/32" [2273]
86 9/16" [2199]
85 13/16" [2180]
72 11/16" [1846]

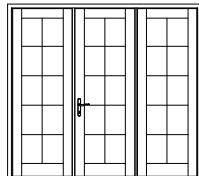

WOSWT7670

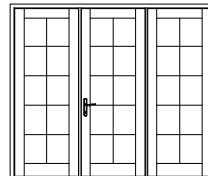

WOSWT8070

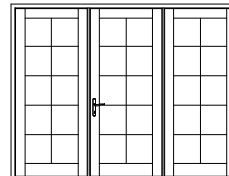

WOSWT9070

99 15/16" [2538]
101 15/32" [2577]
98 9/16" [2503]
97 13/16" [2484]
84 11/16" [2151]

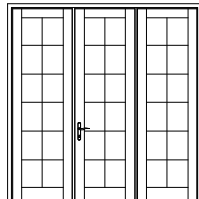

WOSWT7680

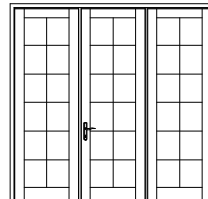

WOSWT8080

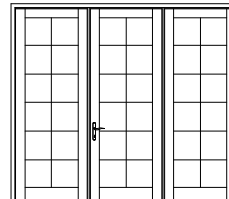

WOSWT9080

111 15/16" [2843]
113 15/32" [2882]
110 9/16" [2808]
109 13/16" [2789]
96 11/16" [2456]

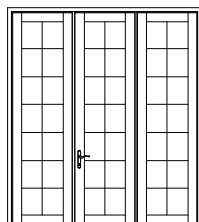

WOSWT7690

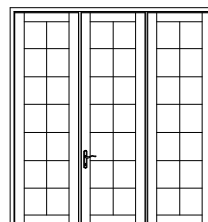

WOSWT8090

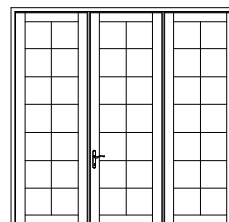

WOSWT9090

ELEVATION SYMBOL LEGEND:
M.O. = MASONRY OPENING
VALUES IN [] ARE IN MILLIMETER CONVERSIONS.
VALUES IN () ARE NUMBER OF DAYLIGHT OPENINGS PER UNIT.

Note: Elevations shown DO NOT have exterior trim. Subtract 1/2" (12.7) from M.O. (Masonry Opening) for Unit Size. For other Trim Options refer to the Unit Sizing, Rough Opening & Masonry Openings page.

SCALE: 1/8" = 1'

2-PANEL FRENCH UNITS

M.O. BRICKMOULD 50 3/8" [1280]
M.O. ADAMS/FLAT CASING 53 7/16" [1357]
ROUGH OPENING 47 3/8" [1203]
FRAME SIZE 46 5/8" [1184]
DAYLIGHT OPENING 12 5/8" [321] (2)

80 15/16" [2056]
 82 15/32" [2095]
 79 9/16" [2021]
 78 13/16" [2002]
 65 11/16" [1668]

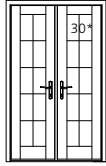

WOFRR4068

62 3/8" [1584]
 65 7/16" [1662]
 59 3/8" [1507]
 58 5/8" [1489]
 18 5/8" [473] (2)

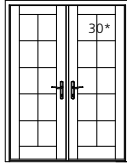

WOFRR5068

66 3/8" [1686]
 69 7/16" [1764]
 63 3/8" [1610]
 62 5/8" [1591]
 20 5/8" [524] (2)

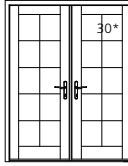

WOFRR5468

74 3/8" [1889]
 77 7/16" [1967]
 71 3/8" [1813]
 70 5/8" [1794]
 24 5/8" [625] (2)

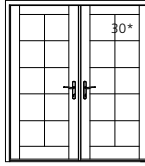

WOFRR6068

96 15/16" [2462]
 98 15/32" [2501]
 95 9/16" [2427]
 94 13/16" [2408]
 81 11/16" [2075]

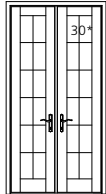

WOFRR4080

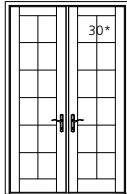

WOFRR5080

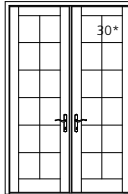

WOFRR5480

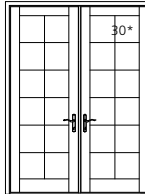

WOFRR6080

108 15/16" [2767]
 110 15/32" [2806]
 107 9/16" [2732]
 106 13/16" [2713]
 93 11/16" [2380]

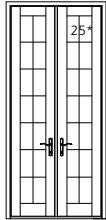

WOFRR4090

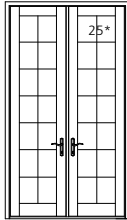

WOFRR5090

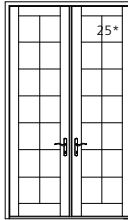

WOFRR5490

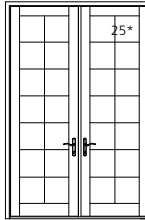

WOFRR6090

M.O. BRICKMOULD 54 3/8" [1381]
M.O. ADAMS/FLAT CASING 57 7/16" [1459]
ROUGH OPENING 51 3/8" [1304]
FRAME SIZE 50 5/8" [1286]
DAYLIGHT OPENING 14 5/8" [371] (2)

83 15/16" [2132]
 85 15/32" [2171]
 82 9/16" [2097]
 81 13/16" [2078]
 68 11/16" [1745]

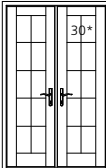

WOFRT4068

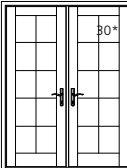

WOFRT5068

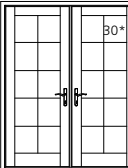

WOFRT5468

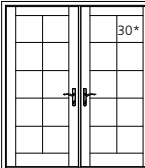

WOFRT6068

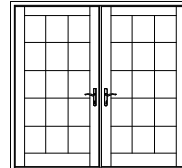

WOFRT7068

87 15/16" [2234]
 89 15/32" [2273]
 86 9/16" [2199]
 85 13/16" [2180]
 72 11/16" [1846]

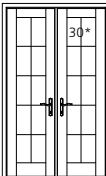

WOFRT4070

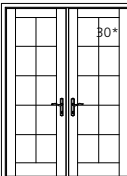

WOFRT5070

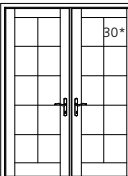

WOFRT5470

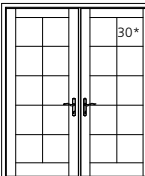

WOFRT6070

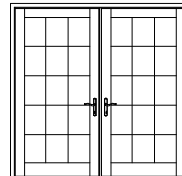

WOFRT7070

99 15/16" [2538]
 101 15/32" [2577]
 98 9/16" [2497]
 97 13/16" [2484]
 85 3/4" [2178]

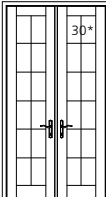

WOFRT4080

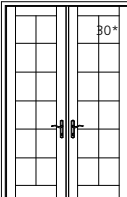

WOFRT5080

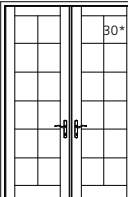

WOFRT5480

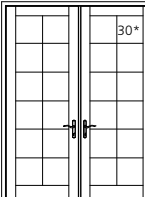

WOFRT6080

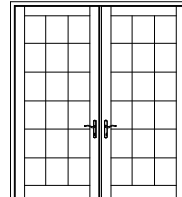

WOFRT7080

111 15/16" [2843]
 113 15/32" [2882]
 110 9/16" [2808]
 109 13/16" [2789]
 96 11/16" [2456]

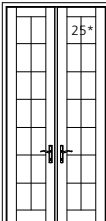

WOFRT4090

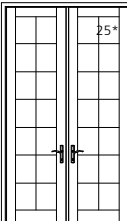

WOFRT5090

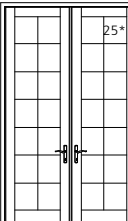

WOFRT5490

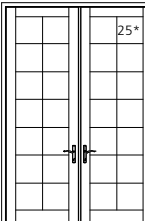

WOFRT6090

ELEVATION SYMBOL LEGEND:
M.O. = MASONRY OPENING
 VALUES IN [] ARE IN MILLIMETER CONVERSIONS.
 VALUES IN () ARE NUMBER OF DAYLIGHT OPENINGS PER UNIT.
= NUMBER INDICATES DESIGN PRESSURE (DP) RATING WITH STANDARD GLAZING. OPERATING UNITS UTILIZE MULTI-POINT LOCKING HARDWARE FOR DP RATINGS.

Note: Elevations shown DO NOT have exterior trim. Subtract 1/2" (12.7) from M.O. (Masonry Opening) for Unit Size. For other Trim Options refer to the Unit Sizing, Rough Opening & Masonry Openings page.

SCALE: 1/8" = 1'

4-PANEL FRENCH UNITS

M.O. BRICKMOULD
M.O. ADAMS/FLAT CASING
ROUGH OPENING
FRAME SIZE
DAYLIGHT OPENING

96 3/4" [2457]
99 13/16" [2535]
93 3/4" [2381]
93" [2362]
12 5/8" [321] (4)

120 3/4" [3067]
123 13/16" [3145]
117 3/4" [2991]
117" [2972]
18 5/8" [473] (4)

144 3/4" [3677]
147 13/16" [3754]
141 3/4" [3600]
141" [3581]
24 5/8" [625] (4)

80 15/16" [2056]
82 15/32" [2095]
79 9/16" [2021]
78 13/16" [2002]
65 11/16" [1668]

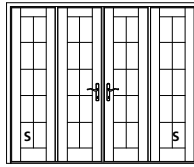

WOFRR8068

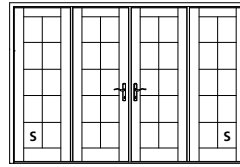

WOFRR10068

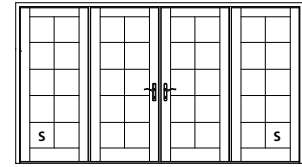

WOFRR12068

96 15/16" [2462]
98 15/32" [2501]
95 9/16" [2427]
94 13/16" [2408]
81 11/16" [2075]

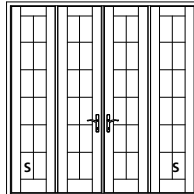

WOFRR8080

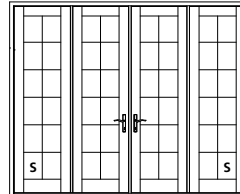

WOFRR10080

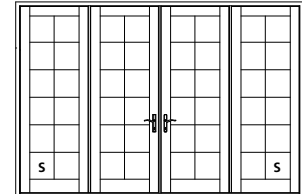

WOFRR12080

108 15/16" [2767]
110 15/32" [2806]
107 9/16" [2732]
106 13/16" [2713]
93 11/16" [2380]

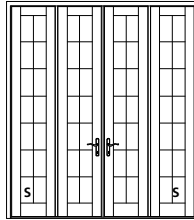

WOFRR8090

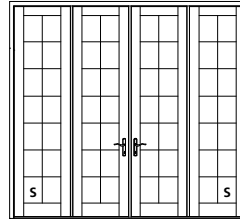

WOFRR10090

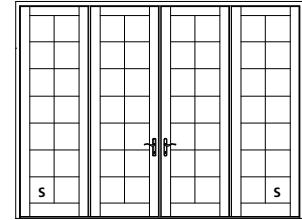

WOFRR12090

M.O. BRICKMOULD
M.O. ADAMS/FLAT CASING
ROUGH OPENING
FRAME SIZE
DAYLIGHT OPENING

104 3/4" [2661]
107 13/16" [2738]
101 3/4" [2584]
101" [2565]
14 5/8" [371] (4)

128 3/4" [3270]
131 13/16" [3348]
125 3/4" [3194]
125" [3175]
20 5/8" [524] (4)

152 3/4" [3880]
155 13/16" [3958]
149 3/4" [3803]
149" [3785]
26 5/8" [676] (4)

83 15/16" [2132]
85 15/32" [2171]
82 9/16" [2097]
81 13/16" [2078]
68 11/16" [1745]

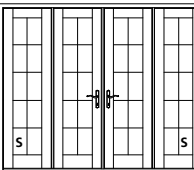

WOFRT8068

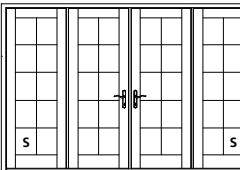

WOFRT10068

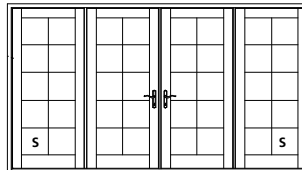

WOFRT12068

87 15/16" [2234]
89 15/32" [2273]
86 9/16" [2199]
85 13/16" [2180]
72 11/16" [1846]

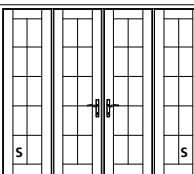

WOFRT8070

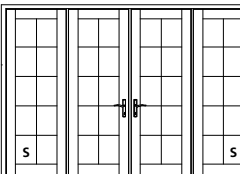

WOFRT10070

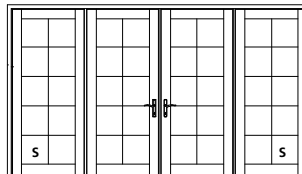

WOFRT12070

99 15/16" [2538]
101 15/32" [2577]
98 9/16" [2497]
97 13/16" [2484]
84 11/16" [2151]

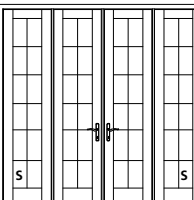

WOFRT8080



WOFRT10080

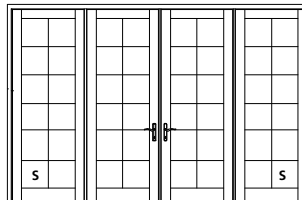

WOFRT12080

111 15/16" [2843]
113 15/32" [2882]
110 9/16" [2808]
109 13/16" [2789]
96 11/16" [2456]

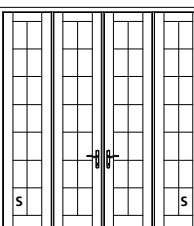

WOFRT8090

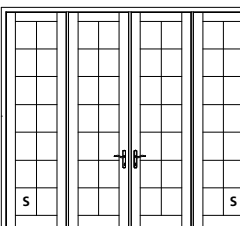

WOFRT10090

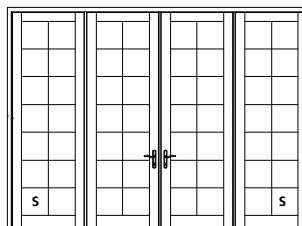

WOFRT12090

ELEVATION SYMBOL LEGEND:
M.O. = MASONRY OPENING
VALUES IN [] ARE IN MILLIMETER CONVERSIONS.
VALUES IN () ARE NUMBER OF DAYLIGHT OPENINGS PER UNIT.
S = PANEL IS AVAILABLE AS STATIONARY ONLY.

Note: Elevations shown DO NOT have exterior trim.
Subtract 1/2" (12.7) from M.O. (Masonry Opening)
for Unit Size. For other Trim Options refer to the Unit
Sizing, Rough Opening & Masonry Openings page.

SCALE: 1/8" = 1'

SINGLE DOOR WITH SINGLE SIDELITE

M.O. BRICKMOULD	54 1/2" [1384]	56 1/2" [1435]	58 1/2" [1486]
M.O. ADAMS/FLAT CASING	57 9/16" [1462]	59 9/16" [1513]	61 9/16" [1564]
ROUGH OPENING	51 1/2" [1308]	53 1/2" [1359]	55 1/2" [1409]
FRAME SIZE	50 3/4" [1289]	52 3/4" [1340]	54 3/4" [1391]
DAYLIGHT OPENING	26 5/8" [676] - 7 1/2" [190]	26 5/8" [703] - 9 1/2" [241]	26 5/8" [676] - 11 1/2" [292]
83 15/16" [2132] 85 15/32" [2171] 82 9/16" [2097] 81 13/16" [2078] 68 11/16" [1745]			
87 15/16" [2234] 89 15/32" [2273] 86 9/16" [2199] 85 13/16" [2180] 72 11/16" [1846]			
99 15/16" [2538] 101 15/32" [2577] 98 9/16" [2503] 97 13/16" [2484] 84 11/16" [2151]			
111 15/16" [2843] 113 15/32" [2882] 110 9/16" [2808] 109 13/16" [2789] 96 11/16" [2456]			
M.O. BRICKMOULD	60 1/2" [1537]	62 1/2" [1588]	64 1/2" [1638]
M.O. ADAMS/FLAT CASING	63 9/16" [1614]	65 9/16" [1665]	67 9/16" [1716]
ROUGH OPENING	57 1/2" [1460]	59 1/2" [1511]	61 1/2" [1562]
FRAME SIZE	56 3/4" [1441]	58 3/4" [1492]	60 3/4" [1543]
DAYLIGHT OPENING	32 5/8" [829] - 7 1/2" [190]	32 5/8" [829] - 9 1/2" [241]	32 5/8" [829] - 11 1/2" [292]
83 15/16" [2132] 85 15/32" [2171] 82 9/16" [2097] 81 13/16" [2078] 68 11/16" [1745]			
87 15/16" [2234] 89 15/32" [2273] 86 9/16" [2199] 85 13/16" [2180] 72 11/16" [1846]			
99 15/16" [2538] 101 15/32" [2577] 98 9/16" [2503] 97 13/16" [2484] 84 11/16" [2151]			

ELEVATION SYMBOL LEGEND:
M.O. = MASONRY OPENING
 VALUES IN [] ARE IN MILLIMETER CONVERSIONS.
 VALUES IN () ARE NUMBER OF DAYLIGHT OPENINGS PER UNIT.
 S = PANEL IS AVAILABLE AS STATIONARY ONLY.

Note: Elevations shown DO NOT have exterior trim. Subtract 1/2" (12.7) from M.O. (Masonry Opening) for Unit Size. For other Trim Options refer to the Unit Sizing, Rough Opening & Masonry Openings page.

SCALE: 1/8" = 1'

SINGLE DOOR WITH TWO SIDELITES

M.O. BRICKMOULD
M.O. ADAMS/FLAT CASING
ROUGH OPENING
FRAME SIZE
DAYLIGHT OPENING

67 13/16" [1722]
70 7/8" [1800]
64 13/16" [1646]
64 1/16" [1627]
26 5/8" [676] - 7 1/2" [190] (2)

71 13/16" [1824]
74 7/8" [1902]
68 13/16" [1747]
68 1/16" [1729]
26 5/8" [676] - 9 1/2" [241] (2)

75 13/16" [1926]
78 7/8" [2003]
72 13/16" [1849]
72 1/16" [1830]
26 5/8" [676] - 11 1/2" [292] (2)

83 15/16" [2132]
85 15/32" [2171]
82 9/16" [2097]
81 13/16" [2078]
68 11/16" [1745]

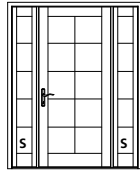

WOSWT3068F10

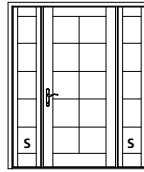

WOSWT3068F12

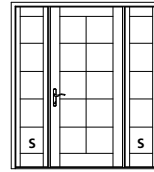

WOSWT3068F14

87 15/16" [2234]
89 15/32" [2273]
86 9/16" [2199]
85 13/16" [2180]
72 11/16" [1846]

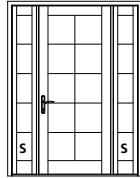

WOSWT3070F10

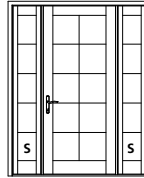

WOSWT3070F12

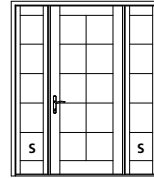

WOSWT3070F14

99 15/16" [2538]
101 15/32" [2577]
98 9/16" [2503]
97 13/16" [2484]
84 11/16" [2151]

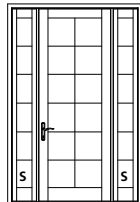

WOSWT3080F10

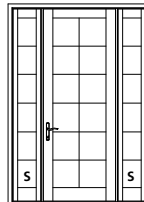

WOSWT3080F12

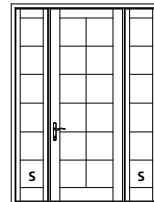

WOSWT3080F14

111 15/16" [2843]
113 15/32" [2882]
110 9/16" [2808]
109 13/16" [2789]
96 11/16" [2456]

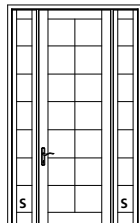

WOSWT3090F10

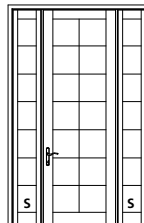

WOSWT3090F12

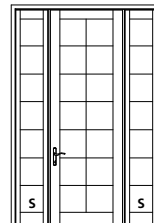

WOSWT3090F14

M.O. BRICKMOULD
M.O. ADAMS/FLAT CASING
ROUGH OPENING
FRAME SIZE
DAYLIGHT OPENING

73 13/16" [1875]
76 7/8" [1953]
70 13/16" [1799]
70 1/16" [1780]
32 5/8" [829] - 7 1/2" [190] (2)

77 13/16" [1976]
80 7/8" [2054]
74 13/16" [1900]
74 1/16" [1881]
32 5/8" [829] - 9 1/2" [241] (2)

81 13/16" [2078]
84 7/8" [2156]
78 13/16" [2002]
78 1/16" [1983]
32 5/8" [829] - 11 1/2" [292] (2)

83 15/16" [2132]
85 15/32" [2171]
82 9/16" [2097]
81 13/16" [2078]
68 11/16" [1745]

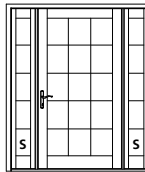

WOSWT3668F10

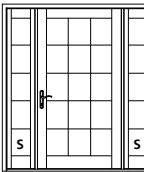

WOSWT3668F12

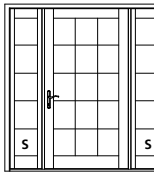

WOSWT3668F14

87 15/16" [2234]
89 15/32" [2273]
86 9/16" [2192]
85 13/16" [2180]
72 11/16" [1846]

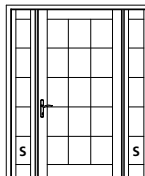

WOSWT3670F10

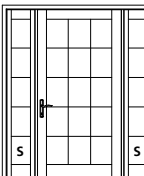

WOSWT3670F12

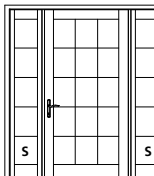

WOSWT3670F14

99 15/16" [2538]
101 15/32" [2577]
98 9/16" [2503]
97 13/16" [2484]
84 11/16" [2151]

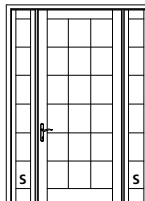

WOSWT3680F10

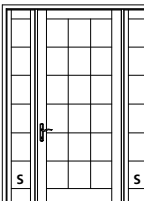

WOSWT3680F12

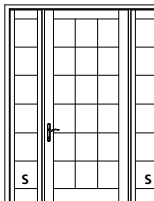

WOSWT3680F14

ELEVATION SYMBOL LEGEND:
M.O. = MASONRY OPENING
VALUES IN [] ARE IN MILLIMETER CONVERSIONS.
VALUES IN () ARE NUMBER OF DAYLIGHT OPENINGS PER UNIT.
S = PANELS AVAILABLE AS STATIONARY ONLY.

Note: Elevations shown DO NOT have exterior trim. Subtract 1/2" (12.7) from M.O. (Masonry Opening) for Unit Size. For other Trim Options refer to the Unit Sizing, Rough Opening & Masonry Openings page.

SCALE: 1/8" = 1'

FRENCH DOOR WITH TWO SIDELITES
5-0 UNITS

M.O. BRICKMOLD
M.O. ADAMS/FLAT CASING
ROUGH OPENING
FRAME SIZE
DAYLIGHT OPENING

93" [2362]
96 1/16" [2440]
90" [2286]
89 1/4" [2267]
20 5/8" [524] (2) - 7 1/2" [190] (2)

97" [2464]
100 1/16" [2542]
94" [2387]
93 1/4" [2369]
20 5/8" [524] (2) - 9 1/2" [241] (2)

101" [2565]
104 1/16" [2643]
98" [2489]
97 1/4" [2470]
20 5/8" [524] (2) - 11 1/2" [292] (2)

83 15/16" [2132]
85 13/32" [2171]
82 9/16" [2097]
81 13/16" [2078]
68 11/16" [1745]

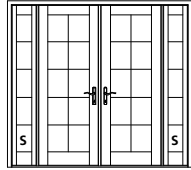

WOFRT5068Q10

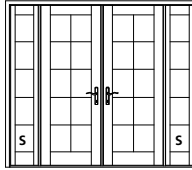

WOFRT5068Q12

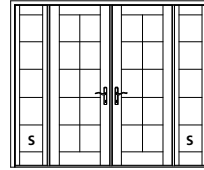

WOFRT5068Q14

87 15/16" [2234]
89 15/32" [2273]
86 9/16" [2198]
85 13/16" [2180]
72 11/16" [1846]

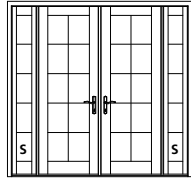

WOFRT5070Q10

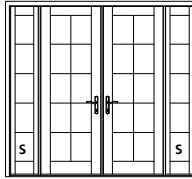

WOFRT5070Q12

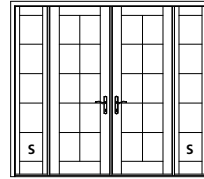

WOFRT5070Q14

99 15/16" [2538]
101 15/32" [2577]
98 9/16" [2503]
97 13/16" [2484]
84 11/16" [2151]

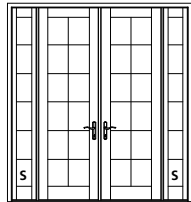

WOFRT5080Q10

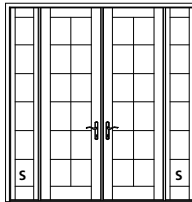

WOFRT5080Q12

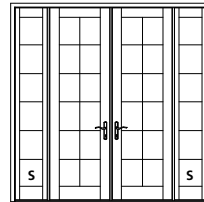

WOFRT5080Q14

111 15/16" [2843]
113 15/32" [2882]
110 9/16" [2808]
109 13/16" [2789]
96 11/16" [2456]

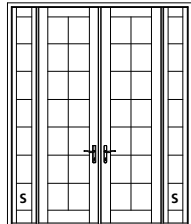

WOFRT5090Q10

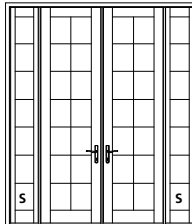

WOFRT5090Q12

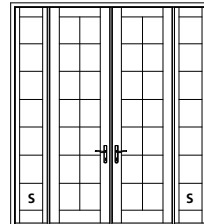

WOFRT5090Q14

ELEVATION SYMBOL LEGEND:
M.O. = MASONRY OPENING
VALUES IN [] ARE IN MILLIMETER CONVERSIONS.
VALUES IN () ARE NUMBER OF DAYLIGHT OPENINGS PER UNIT.
S = PANEL IS AVAILABLE AS STATIONARY ONLY.

Note: Elevations shown DO NOT have exterior trim. Subtract 1/2" (12.7) from M.O. (Masonry Opening) for Unit Size. For other Trim Options refer to the Unit Sizing, Rough Opening & Masonry Openings page.

SCALE: 1/8" = 1'

FRENCH DOOR WITH TWO SIDELITES
5-4 UNITS

M.O. BRICKMOUND
M.O. ADAMS/FLAT CASING
ROUGH OPENING
FRAME SIZE
DAYLIGHT OPENING

97" [2464]
100 1/16" [2542]
94" [2388]
93 1/4" [2369]
22 5/8" [575] (2) - 7 1/2" [190] (2)

101" [2565]
104 1/16" [2643]
98" [2489]
97 1/4" [2470]
22 5/8" [575] (2) - 9 1/2" [418] (2)

105" [2667]
108 1/16" [2745]
102" [2591]
101 1/4" [2572]
22 5/8" [575] (2) - 11 1/2" [292] (2)

83 15/16" [2132]
85 15/32" [2171]
82 9/16" [2097]
81 13/16" [2078]
68 11/16" [1745]

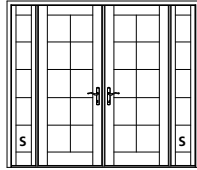

WOFRT5468Q10

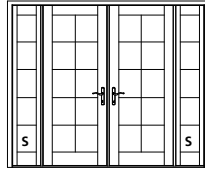

WOFRT5468Q12

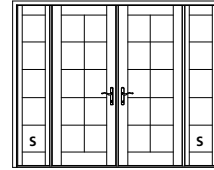

WOFRT5468Q14

87 15/16" [2234]
89 15/32" [2273]
86 9/16" [2199]
85 13/16" [2180]
72 11/16" [1846]

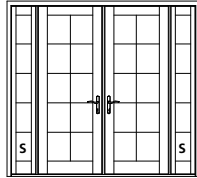

WOFRT5470Q10

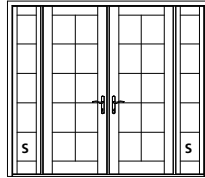

WOFRT5470Q12

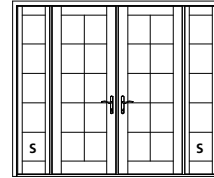

WOFRT5470Q14

99 15/16" [2538]
101 15/32" [2577]
98 9/16" [2503]
85 13/16" [2484]
84 11/16" [2151]

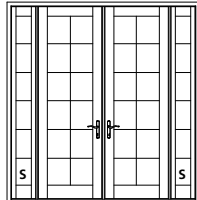

WOFRT5480Q10

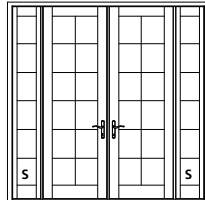

WOFRT5480Q12

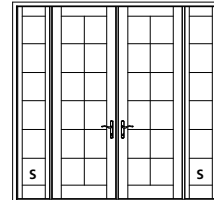

WOFRT5480Q14

111 15/16" [2843]
113 15/32" [2882]
110 9/16" [2808]
109 13/16" [2789]
96 11/16" [2456]

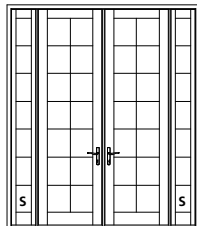

WOFRT5490Q10

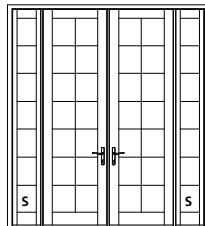

WOFRT5490Q12

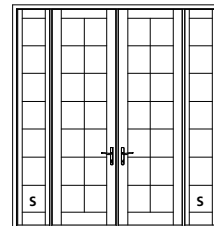

WOFRT5490Q14

ELEVATION SYMBOL LEGEND:

M.O. = MASONRY OPENING
VALUES IN [] ARE IN MILLIMETER CONVERSIONS.
VALUES IN () ARE NUMBER OF DAYLIGHT OPENINGS PER UNIT.
S PANELS AVAILABLE AS STATIONARY ONLY.

Note: Elevations shown DO NOT have exterior trim. Subtract 1/2" (12.7) from M.O. (Masonry Opening) for Unit Size. For other Trim Options refer to the Unit Sizing, Rough Opening & Masonry Openings page.

SCALE: 1/8" = 1'

FRENCH DOOR WITH TWO SIDELITES
6-0 UNITS

M.O. BRICKMOULD
M.O. ADAMS/FLAT CASING
ROUGH OPENING
FRAME SIZE
DAYLIGHT OPENING

105" [2667]
108 1/16" [2745]
102" [2591]
101 1/4" [2572]
26 5/8" [676] (2) - 7 1/2" [190] (2)

109" [2769]
112 1/16" [2846]
106" [2692]
105 1/4" [2673]
26 5/8" [676] (2) - 9 1/2" [241] (2)

113" [2870]
116 1/16" [2948]
110" [2794]
109 1/4" [2775]
26 5/8" [676] (2) - 11 1/2" [292] (2)

83 15/16" [2132]
85 15/32" [2171]
82 9/16" [2097]
81 13/16" [2078]
68 11/16" [1745]

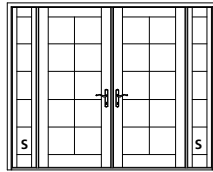

WOFRT6068Q10

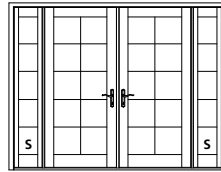

WOFRT6068Q12

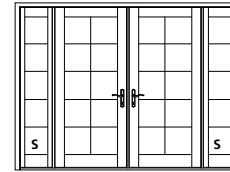

WOFRT6068Q14

87 15/16" [2234]
89 15/32" [2273]
86 9/16" [2198]
85 13/16" [2180]
72 11/16" [1846]

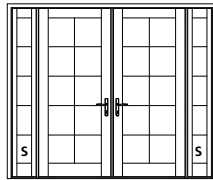

WOFRT6070Q10

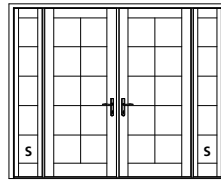

WOFRT6070Q12

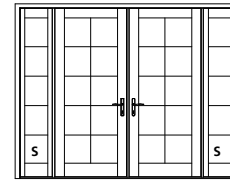

WOFRT6070Q14

99 15/16" [2538]
101 15/32" [2577]
98 9/16" [2503]
97 13/16" [2484]
84 11/16" [2151]

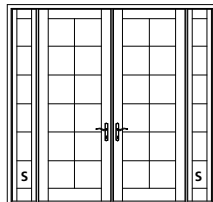

WOFRT6080Q10

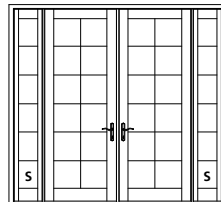

WOFRT6080Q12

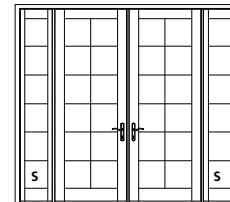

WOFRT6080Q14

111 15/16" [2843]
113 15/32" [2882]
110 9/16" [2808]
109 13/16" [2789]
96 11/16" [2456]

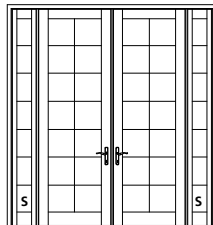

WOFRT6090Q10

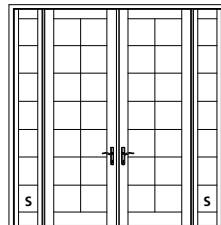

WOFRT6090Q12

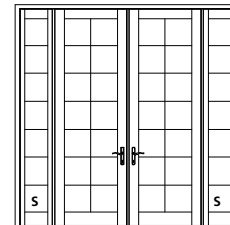

WOFRT6090Q14

ELEVATION SYMBOL LEGEND:

M.O. = MASONRY OPENING
VALUES IN () ARE IN MILLIMETER CONVERSIONS.
VALUES IN () ARE NUMBER OF DAYLIGHT OPENINGS PER UNIT.
S = PANELS AVAILABLE AS STATIONARY ONLY.

Note: Elevations shown DO NOT have exterior trim. Subtract 1/2" (12.7) from M.O. (Masonry Opening) for Unit Size. For other Trim Options refer to the Unit Sizing, Rough Opening & Masonry Openings page.

SCALE: 1/8" = 1'

FRENCH DOOR WITH TWO SIDELITES
7-0 UNITS

**M.O. BRICKMOUND
M.O. ADAMS/FLAT CASING
ROUGH OPENING
FRAME SIZE
DAYLIGHT OPENING**

117" [2972]
120 1/16" [3050]
114" [2896]
113 1/4" [2877]
32 5/8" [829] (2) - 7 1/2" [190] (2)

121" [3073]
124 1/16" [3151]
118" [2997]
117 1/4" [2978]
32 5/8" [829] (2) - 9 1/2" [241] (2)

125" [3175]
128 1/16" [3253]
122" [3099]
121 1/4" [3080]
32 5/8" [829] (2) - 11 5/8" [292] (2)

83 15/16" [2132]
85 15/32" [2171]
82 9/16" [2097]
81 13/16" [2078]
68 11/16" [1745]

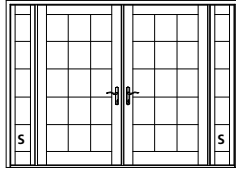

WOFRT7068Q10

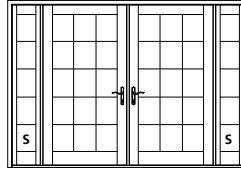

WOFRT7068Q12

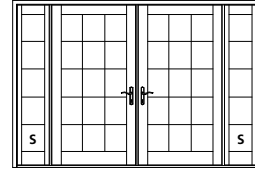

WOFRT7068Q14

87 15/16" [2234]
89 15/32" [2273]
86 9/16" [2199]
85 13/16" [2180]
72 11/16" [1846]

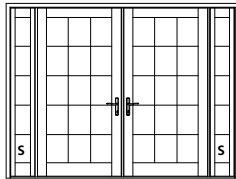

WOFRT7070Q10

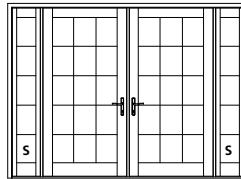

WOFRT7070Q12

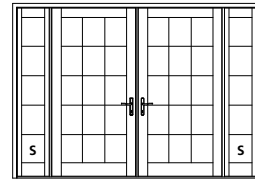

WOFRT7070Q14

99 15/16" [2538]
101 15/32" [2577]
98 9/16" [2503]
97 13/16" [2484]
84 11/16" [2151]

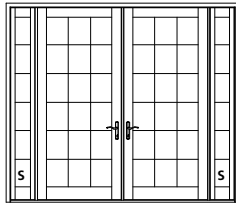

WOFRT7080Q10

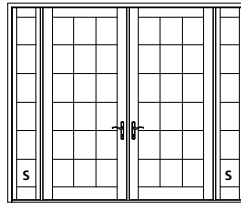

WOFRT7080Q12

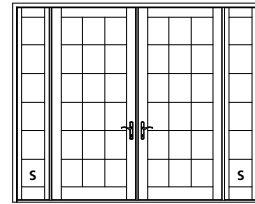

WOFRT7080Q14

ELEVATION SYMBOL LEGEND:

M.O. = MASONRY OPENING
VALUES IN [] ARE IN MILLIMETER CONVERSIONS.
VALUES IN () ARE NUMBER OF DAYLIGHT OPENINGS PER UNIT.
S PANEL IS AVAILABLE AS STATIONARY ONLY.

Note: Elevations shown DO NOT have exterior trim. Subtract 1/2" (12.7) from M.O. (Masonry Opening) for Unit Size. For other Trim Options refer to the Unit Sizing, Rough Opening & Masonry Openings page.

SCALE: 1/8" = 1'

SINGLE SASH TRANSOMS

M.O. BRICKMOULD
M.O. ADAMS/FLAT CASING
ROUGH OPENING
FRAME SIZE
DAYLIGHT OPENING

27 3/16" [691]
30 1/4" [768]
24 3/16" [615]
23 7/16" [595]
12 5/8" [321]

33 3/16" [843]
36 1/4" [921]
30 3/16" [766]
29 7/16" [748]
18 5/8" [473]

39 3/16" [995]
42 1/4" [1073]
36 3/16" [919]
35 7/16" [900]
24 5/8" [625]

50 3/8" [1280]
53 7/16" [1357]
47 3/8" [1203]
46 5/8" [1184]
35 13/16" [910]

62 3/8" [1584]
65 7/16" [1662]
59 3/8" [1508]
58 5/8" [1489]
48 13/16" [1214]

74 3/8" [1889]
77 7/16" [1967]
71 3/8" [1815]
70 5/8" [1794]
60 13/16" [1519]

21 3/4" [552]
24 13/16" [630]
18 3/4" [476]
18" [457]
12 1/16" [306]



WTOSWR2016



WTOSWR2616



WTOSWR3016



WTOFRR4016



WTOFRR5016



WTOFRR6016

33 3/4" [857]
36 13/16" [935]
30 3/4" [781]
30" [762]
24 1/16" [611]



WTOSWR2026



WTOSWR2626



WTOSWR3026

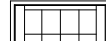

WTOFRR4026

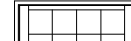

WTOFRR5026

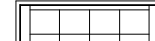

WTOFRR6026

M.O. BRICKMOULD
M.O. ADAMS/FLAT CASING
ROUGH OPENING
FRAME SIZE
DAYLIGHT OPENING

17 5/16" [440]
20 3/8" [518]
14 5/16" [363]
13 9/16" [344]
7 1/2" [190]

19 5/16" [491]
22 3/8" [568]
16 5/16" [415]
15 9/16" [395]
9 1/2" [241]

21 5/16" [541]
24 3/8" [619]
18 5/16" [465]
17 9/16" [446]
11 1/2" [292]

29 3/16" [741]
32 1/4" [819]
26 3/16" [665]
25 7/16" [646]
14 5/8" [371]

35 3/16" [894]
38 1/4" [972]
33 3/16" [817]
31 7/16" [799]
20 5/8" [524]

37 3/16" [945]
40 1/4" [1022]
34 3/16" [868]
33 7/16" [849]
22 5/8" [524]

41 3/16" [1046]
44 1/4" [1124]
38 3/16" [970]
37 7/16" [951]
26 5/8" [676]

47 3/16" [1199]
50 1/4" [1276]
44 3/16" [1122]
43 7/16" [1103]
32 5/8" [829]

21 3/4" [552]
24 13/16" [630]
18 3/4" [476]
18" [457]
12 1/16" [306]



WTOSWT1016



WTOSWT1216



WTOSWT1416



WTOSWT2016



WTOSWT2616



WTOSWT2816



WTOSWT3016



WTOSWT3616

33 3/4" [857]
36 13/16" [935]
30 3/4" [781]
30" [762]
24 1/16" [611]



WTOSWT1026



WTOSWT1226



WTOSWT1426



WTOSWT2026



WTOSWT2626



WTOSWT2826



WTOSWT3026



WTOSWT3626

M.O. BRICKMOULD
M.O. ADAMS/FLAT CASING
ROUGH OPENING
FRAME SIZE
DAYLIGHT OPENING

54 3/8" [1381]
57 7/16" [1459]
51 3/8" [1305]
50 5/8" [1286]
39 13/16" [1011]

66 3/8" [1686]
69 7/16" [1764]
63 3/8" [1609]
62 5/8" [1591]
51 13/16" [1316]

70 3/8" [1788]
73 7/16" [1865]
67 3/8" [1711]
66 5/8" [1692]
55 13/16" [1418]

78 3/8" [1991]
81 7/16" [2069]
75 3/8" [1914]
74 5/8" [1895]
63 13/16" [1621]

81 7/16" [2069]
87 3/8" [2219]
86 5/8" [2200]

90 3/8" [2296]
93 7/16" [2373]
87 3/8" [2219]
86 5/8" [2200]

90 3/8" [2296]
93 7/16" [2373]
87 3/8" [2219]
86 5/8" [2200]

21 3/4" [552]
24 13/16" [630]
18 3/4" [476]
18" [457]
12 1/16" [306]



WTOFRT4016



WTOFRT5016



WTOFRT5416



WTOFRT6016



WTOFRT7016

33 3/4" [857]
36 13/16" [935]
30 3/4" [781]
30" [762]
24 1/16" [611]



WTOFRT4026



WTOFRT5026



WTOFRT5426



WTOFRT6026



WTOFRT7026

ELEVATION SYMBOL LEGEND:

M.O. = MASONRY OPENING

VALUES IN () ARE NUMBER OF DAYLIGHT OPENINGS PER UNIT.

VALUES IN [] ARE IN MILLIMETER CONVERSIONS.

Note: Elevations shown DO NOT have exterior trim. Subtract 1/2" (12.7) from M.O. (Masonry Opening) for Unit Sizes. Masonry Openings above include Sill Nose, see Transom Rail & Sill Options page for Sill Nose specifications. For other Trim Options refer to the Unit Sizing, Rough Opening & Masonry Openings page.

SCALE: 1/8" = 1'

2-SASH TRANSOMS

M.O. BRICKMOULD
M.O. ADAMS/FLAT CASING
ROUGH OPENING
FRAME SIZE
DAYLIGHT OPENING

50 3/8" [1280]	62 3/8" [1584]	74 3/8" [1889]	54 3/8" [1381]
53 7/16" [1357]	65 7/16" [1662]	77 7/16" [1967]	57 7/16" [1459]
47 3/8" [1203]	59 3/8" [1508]	71 3/8" [1812]	51 3/8" [1304]
46 5/8" [1184]	58 5/8" [1489]	70 5/8" [1794]	50 5/8" [1286]
12 5/8" [321] (2)	18 5/8" [473] (2)	24 5/8" [625] (2)	14 5/8" [371] (2)

21 3/4" [552]
24 13/16" [630]
18 3/4" [476]
18" [457]
12 1/16" [306]

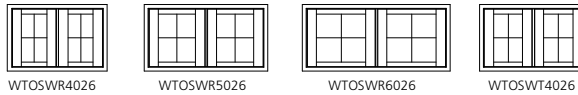
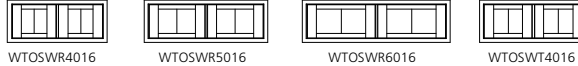

M.O. BRICKMOULD
M.O. ADAMS/FLAT CASING
ROUGH OPENING
FRAME SIZE
DAYLIGHT OPENING

66 3/8" [1686]	70 3/8" [1788]	78 3/8" [1991]	90 3/8" [2269]
69 7/16" [1764]	73 7/16" [1865]	81 7/16" [2069]	93 7/16" [2373]
63 3/8" [1610]	67 3/8" [1711]	75 3/8" [1914]	87 3/8" [2219]
62 5/8" [1591]	66 5/8" [1692]	74 5/8" [1895]	86 5/8" [2200]
20 5/8" [524] (2)	22 5/8" [575] (2)	26 5/8" [676] (2)	32 5/8" [829] (2)

21 3/4" [552]
24 13/16" [630]
18 3/4" [476]
18" [457]
12 1/16" [306]

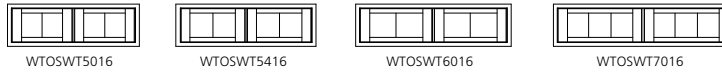

33 3/4" [857]
36 13/16" [935]
30 3/4" [781]
30" [762]
24 1/16" [611]

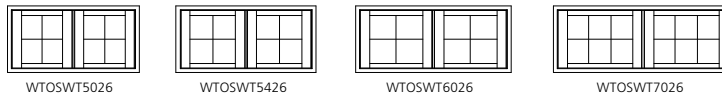

M.O. BRICKMOULD
M.O. ADAMS/FLAT CASING
ROUGH OPENING
FRAME SIZE
DAYLIGHT OPENING

54 1/2" [1384]	56 1/2" [1435]	58 1/2" [1486]
57 9/16" [1462]	59 9/16" [1513]	61 9/16" [1564]
51 1/2" [1308]	53 1/2" [1359]	55 1/2" [1409]
50 3/4" [1289]	52 3/4" [1340]	54 3/4" [1391]
26 5/8" [676] - 7 1/2" [190]	26 5/8" [676] - 9 1/2" [241]	26 5/8" [676] - 11 1/2" [292]

21 3/4" [552]
24 13/16" [630]
18 3/4" [476]
18" [457]
12 1/16" [306]

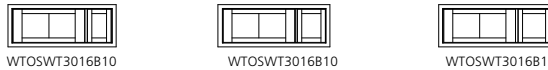

33 3/4" [857]
36 13/16" [935]
30 3/4" [781]
30" [762]
24 1/16" [611]

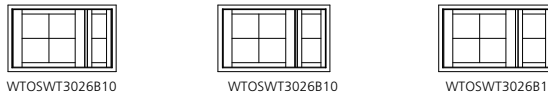

M.O. BRICKMOULD
M.O. ADAMS/FLAT CASING
ROUGH OPENING
FRAME SIZE
DAYLIGHT OPENING

60 1/2" [1537]	62 1/2" [1588]	64 1/2" [1638]
63 9/16" [1614]	65 9/16" [1665]	67 9/16" [1716]
57 1/2" [1460]	59 1/2" [1460]	61 1/2" [1562]
56 3/4" [1441]	58 3/4" [1492]	60 3/4" [1543]
32 5/8" [829] - 7 1/2" [190]	32 5/8" [829] - 9 1/2" [241]	32 5/8" [829] - 11 1/2" [292]

21 3/4" [552]
24 13/16" [630]
18 3/4" [476]
18" [457]
12 1/16" [306]

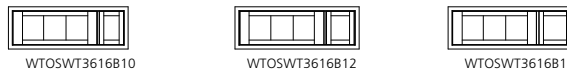

33 3/4" [857]
36 13/16" [935]
30 3/4" [781]
30" [762]
24 1/16" [611]

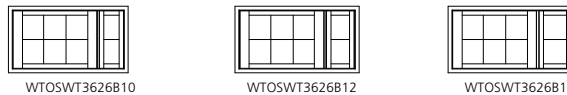



ELEVATION SYMBOL LEGEND:

M.O. = MASONRY OPENING
VALUES IN () ARE NUMBER OF DAYLIGHT OPENINGS PER UNIT.
VALUES IN [] ARE IN MILLIMETER CONVERSIONS.

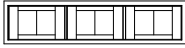
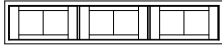
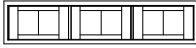
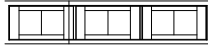

Note: Elevations shown DO NOT have exterior trim. Subtract 1/2" (12.7) from M.O. (Masonry Opening) for Unit Sizes. Masonry Openings above include Sill Nose, see Transom Rail & Sill Options page for Sill Nose specifications. For other Trim Options refer to the Unit Sizing, Rough Opening & Masonry Openings page.

SCALE: 1/8" = 1'

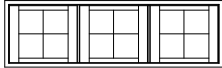
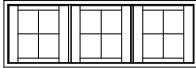
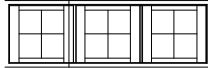
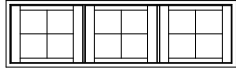
3-SASH TRANSOMS

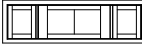
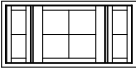
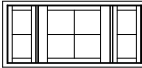
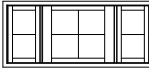
M.O. BRICKMOULD M.O. ADAMS/FLAT CASING ROUGH OPENING FRAME SIZE DAYLIGHT OPENING	91 9/16" [2326] 94 5/8" [2403] 88 9/16" [2249] 87 13/16" [2230] 18 5/8" [473] (3)	109 9/16" [2783] 112 5/8" [2861] 106 9/16" [2707] 105 13/16" [2688] 24 5/8" [625] (3)	97 9/16" [2478] 100 5/8" [2556] 94 9/16" [2402] 93 13/16" [2383] 20 5/8" [524] (3)	103 9/16" [2630] 106 5/8" [2708] 100 9/16" [2554] 99 13/16" [2535] 22 5/8" [608] (3)	115 9/16" [2935] 118 5/8" [3013] 112 9/16" [2859] 111 13/16" [2840] 26 5/8" [676] (3)
	21 3/4" [552] 24 13/16" [630] 18 3/4" [476] 18" [457] 12 1/16" [306]				
33 3/4" [857] 36 13/16" [935] 30 3/4" [781] 30" [762] 24 1/16" [611]					

M.O. BRICKMOULD M.O. ADAMS/FLAT CASING ROUGH OPENING FRAME SIZE DAYLIGHT OPENING	67 13/16" [1722] 70 7/8" [1800] 64 13/16" [1646] 64 1/16" [1627] 26 5/8" [676] - 7 1/2" [190] (2)	71 13/16" [1824] 74 7/8" [1902] 68 13/16" [1747] 68 1/16" [1729] 26 5/8" [676] - 9 1/2" [241] (2)	75 13/16" [1926] 78 7/8" [2003] 72 13/16" [1849] 72 1/16" [1830] 26 5/8" [676] - 11 1/2" [292] (2)
	21 3/4" [552] 24 13/16" [630] 18 3/4" [476] 18" [457] 12 1/16" [306]		
33 3/4" [857] 36 13/16" [935] 30 3/4" [781] 30" [762] 24 1/16" [611]			

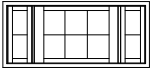
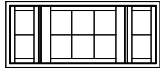
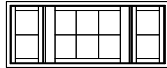
M.O. BRICKMOULD M.O. ADAMS/FLAT CASING ROUGH OPENING FRAME SIZE DAYLIGHT OPENING	73 13/16" [1875] 76 7/8" [1953] 70 13/16" [1798] 70 1/16" [1780] 32 5/8" [829] - 7 1/2" [190] (2)	77 13/16" [1976] 80 7/8" [2054] 74 13/16" [1902] 74 1/16" [1881] 32 5/8" [829] - 9 1/2" [241] (2)	81 13/16" [2078] 84 7/8" [2156] 78 13/16" [2002] 78 1/16" [1983] 32 5/8" [829] - 11 1/2" [292] (2)
	21 3/4" [552] 24 13/16" [630] 18 3/4" [476] 18" [457] 12 1/16" [306]		
33 3/4" [857] 36 13/16" [935] 30 3/4" [781] 30" [762] 24 1/16" [611]			

ELEVATION SYMBOL LEGEND:
M.O. = MASONRY OPENING
 VALUES IN () ARE NUMBER OF DAYLIGHT OPENINGS PER UNIT.
 VALUES IN [] ARE IN MILLIMETER CONVERSIONS.

Note: Elevations shown DO NOT have exterior trim. Subtract 1/2" (12.7) from M.O. (Masonry Opening) for Unit Sizes. Masonry Openings above include Sill Nose, see Transom Rail & Sill Options page for Sill Nose specifications. For other Trim Options refer to the Unit Sizing, Rough Opening & Masonry Openings page.

SCALE: 1/8" = 1'

4-SASH FRENCH TRANSOMS

M.O. BRICKMOUND
M.O. ADAMS/FLAT CASING
ROUGH OPENING
FRAME SIZE
DAYLIGHT OPENING

96 3/4" [2457]
99 13/16" [2535]
93 3/4" [2381]
93" [2362]
12 5/8" [321] (4)

120 3/4" [3067]
123 13/16" [3145]
117 3/4" [2991]
117" [2972]
18 5/8" [473] (4)

144 3/4" [3677]
147 13/16" [3754]
141 3/4" [3600]
141" [3581]
24 5/8" [625] (4)

21 3/4" [552]
24 13/16" [630]
18 3/4" [476]
18" [457]
12 1/16" [306]

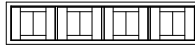

WTOFRR8016

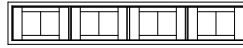

WTOFRR10016

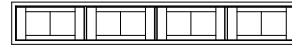

WTOFRR12016

33 3/4" [857]
36 13/16" [935]
30 3/4" [781]
30" [762]
24 1/16" [611]



WTOFRR8026

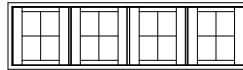

WTOFRR10026

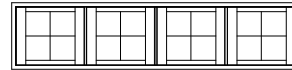

WTOFRR12026

M.O. BRICKMOUND
M.O. ADAMS/FLAT CASING
ROUGH OPENING
FRAME SIZE
DAYLIGHT OPENING

104 3/4" [2661]
107 13/16" [2738]
101 3/4" [2584]
101" [2565]
14 5/8" [371] (4)

128 3/4" [3270]
131 13/16" [3348]
125 3/4" [3194]
125" [3175]
20 5/8" [524] (4)

152 3/4" [3880]
155 13/16" [3958]
149 3/4" [3403]
149" [3785]
26 5/8" [676] (4)

21 3/4" [552]
24 13/16" [630]
18 3/4" [476]
18" [457]
12 1/16" [306]

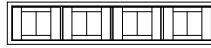

WTOFRT8016

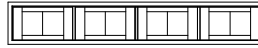

WTOFRT10016

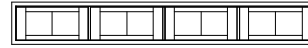

WTOFRT12016

33 3/4" [857]
36 13/16" [935]
30 3/4" [781]
30" [762]
24 1/16" [611]

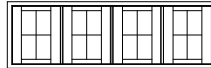

WTOFRT8026

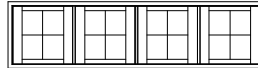

WTOFRT10026

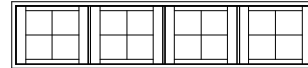

WTOFRT12026

ELEVATION SYMBOL LEGEND:

M.O. = MASONRY OPENING
VALUES IN () ARE NUMBER OF DAYLIGHT OPENINGS PER UNIT.
VALUES IN [] ARE IN MILLIMETER CONVERSIONS.

Note: Elevations shown DO NOT have exterior trim. Subtract 1/2" (12.7) from M.O. (Masonry Opening) for Unit Sizes. Masonry Openings above include Sill Nose, see Transom Rail & Sill Options page for Sill Nose specifications. For other Trim Options refer to the Unit Sizing, Rough Opening & Masonry Openings page.

Continued on next page

SCALE: 1/8" = 1'

FRENCH TRANSOMS WITH TWO SIDELITES

M.O. BRICKMOULD
M.O. ADAMS/FLAT CASING
ROUGH OPENING
FRAME SIZE
DAYLIGHT OPENING

93" [2362]
 96 1/16" [2440]
 90" [2286]
 89 1/4" [2267]
 20 5/8" [524] (2) - 7 1/2" [190] (2)

97" [2464]
 100 1/16" [2542]
 94" [2387]
 93 1/4" [2369]
 20 5/8" [524] (2) - 9 1/2" [241] (2)

101" [2565]
 104 1/16" [2643]
 98" [2489]
 97 1/4" [2470]
 20 5/8" [524] (2) - 11 1/2" [292] (2)

21 3/4" [552]
 24 13/16" [630]
 18 3/4" [476]
 18" [457]
 12 1/16" [306]
 33 3/4" [857]
 36 13/16" [935]
 30 3/4" [781]
 30" [762]
 24 1/16" [611]

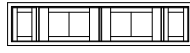

WTOFRT5016Q10

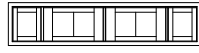

WTOFRT5016Q12

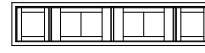

WTOFRT5016Q14

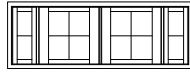

WTOFRT5026Q10

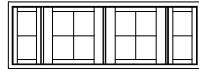

WTOFRT5026Q12

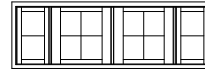

WTOFRT5026Q14

M.O. BRICKMOULD
M.O. ADAMS/FLAT CASING
ROUGH OPENING
FRAME SIZE
DAYLIGHT OPENING

97" [2464]
 100 1/16" [2542]
 94" [2387]
 93 1/4" [2369]
 22 5/8" [575] (2) - 7 1/2" [190] (2)

101" [2565]
 104 1/16" [2643]
 98" [2489]
 97 1/4" [2470]
 22 5/8" [575] (2) - 9 1/2" [241] (2)

105" [2667]
 108 1/16" [2745]
 102" [2590]
 101 1/4" [2572]
 22 5/8" [575] (2) - 11 1/2" [292] (2)

21 3/4" [552]
 24 13/16" [630]
 18 3/4" [476]
 18" [457]
 12 1/16" [306]
 33 3/4" [857]
 36 13/16" [935]
 30 3/4" [781]
 30" [762]
 24 1/16" [611]

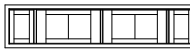

WTOFRT5416Q10

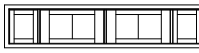

WTOFRT5416Q12

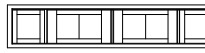

WTOFRT5416Q14

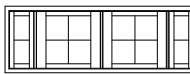

WTOFRT5426Q10

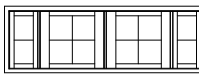

WTOFRT5426Q12

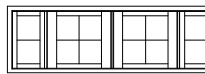

WTOFRT5426Q14

M.O. BRICKMOULD
M.O. ADAMS/FLAT CASING
ROUGH OPENING
FRAME SIZE
DAYLIGHT OPENING

105" [2667]
 108 1/16" [2745]
 102" [2590]
 101 1/4" [2572]
 26 5/8" [676] (2) - 7 1/2" [190] (2)

109" [2769]
 112 1/16" [2846]
 106" [2692]
 105 1/4" [2673]
 26 5/8" [676] (2) - 9 1/2" [241] (2)

113" [2870]
 116 1/16" [2948]
 110" [2794]
 109 1/4" [2775]
 26 5/8" [676] (2) - 11 1/2" [292] (2)

21 3/4" [552]
 24 13/16" [630]
 18 3/4" [476]
 18" [457]
 12 1/16" [306]
 33 3/4" [857]
 36 13/16" [935]
 30 3/4" [781]
 30" [762]
 24 1/16" [611]

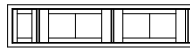

WTOFRT6016Q10

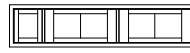

WTOFRT6016Q12

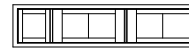

WTOFRT6016Q14

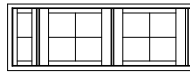

WTOFRT6026Q10

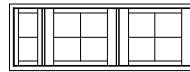

WTOFRT6026Q12

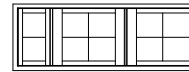

WTOFRT6026Q14

M.O. BRICKMOULD
M.O. ADAMS/FLAT CASING
ROUGH OPENING
FRAME SIZE
DAYLIGHT OPENING

117" [2972]
 120 1/16" [3050]
 114" [2895]
 113 1/4" [2877]
 32 5/8" [829] (2) - 7 1/2" [190] (2)

121" [3073]
 124 1/16" [3151]
 118" [2997]
 117 1/4" [2978]
 32 5/8" [829] (2) - 9 1/2" [241] (2)

125" [3175]
 128 1/16" [3253]
 122" [3098]
 121 1/4" [3080]
 32 5/8" [829] (2) - 11 1/2" [292] (2)

21 3/4" [552]
 24 13/16" [630]
 18 3/4" [476]
 18" [457]
 12 1/16" [306]
 33 3/4" [857]
 36 13/16" [935]
 30 3/4" [781]
 30" [762]
 24 1/16" [611]

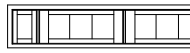

WTOFRT7016Q10

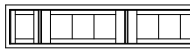

WTOFRT7016Q12

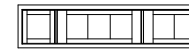

WTOFRT7016Q14

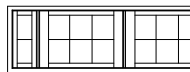

WTOFRT7026Q10

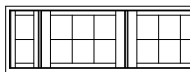

WTOFRT7026Q12

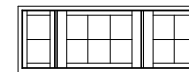

WTOFRT7026Q14

ELEVATION SYMBOL LEGEND:

M.O. = MASONRY OPENING
 VALUES IN () ARE NUMBER OF DAYLIGHT OPENINGS PER UNIT.
 VALUES IN [] ARE IN MILLIMETER CONVERSIONS.

Note: Elevations shown DO NOT have exterior trim. Subtract 1/2" (12.7) from M.O. (Masonry Opening) for Unit Sizes. Masonry Openings above include Sill Nose, see Transom Rail & Sill Options page for Sill Nose specifications. For other Trim Options refer to the Unit Sizing, Rough Opening & Masonry Openings page.

SCALE: 1/8" = 1'

1-PANEL SECTOR TOP DOORS

M.O. BRICKMOLD	29 3/16" [741]	35 3/16" [894]	37 3/16" [945]	41 3/16" [1046]	47 3/16" [1199]
M.O. ADAMS/FLAT CASING	32 1/4" [819]	38 1/4" [972]	40 1/4" [1022]	44 1/4" [1124]	50 1/4" [1276]
ROUGH OPENING	26 3/16" [665]	32 3/16" [817]	34 3/16" [868]	38 3/16" [970]	44 3/16" [1122]
FRAME SIZE	25 7/16" [646]	31 7/16" [799]	33 7/16" [849]	37 7/16" [951]	43 7/16" [1103]
DAYLIGHT OPENING	14 5/8" [371]	20 5/8" [524]	22 5/8" [575]	26 5/8" [676]	32 5/8" [829]

83 15/16" [2132]
85 15/32" [2171]
82 9/16" [2097]
81 13/16" [2078]
68 11/16" [1745]

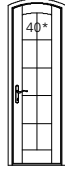

WOSWTS2068

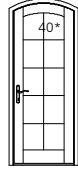

WOSWTS2668

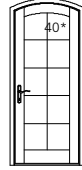

WOSWTS2868

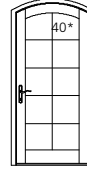

WOSWTS3068

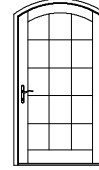

WOSWTS3668

87 15/16" [2234]
89 15/32" [2273]
86 9/16" [2198]
85 13/16" [2180]
72 11/16" [1846]

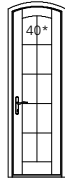

WOSWTS2070



WOSWTS2670

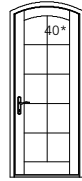

WOSWTS2870

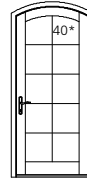

WOSWTS3070

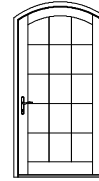

WOSWTS3670

99 15/16" [2538]
101 15/32" [2577]
98 9/16" [2503]
97 13/16" [2484]
84 11/16" [2151]

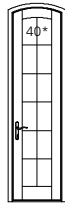

WOSWTS2080

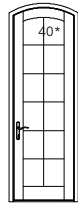

WOSWTS2680

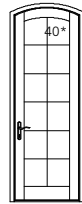

WOSWTS2880

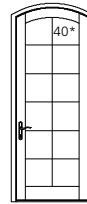

WOSWTS3080

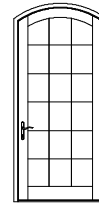

WOSWTS3680

111 15/16" [2843]
113 15/32" [2882]
110 9/16" [2808]
109 13/16" [2789]
96 11/16" [2456]

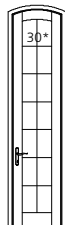

WOSWTS2090

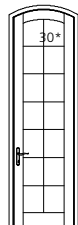

WOSWTS2690

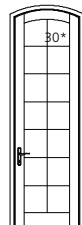

WOSWTS2890

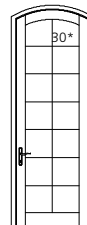

WOSWTS3090

ELEVATION SYMBOL LEGEND:

M.O. = MASONRY OPENING
VALUES IN [] ARE IN MILLIMETER CONVERSIONS.
= NUMBER INDICATES DESIGN PRESSURE (DP) RATING WITH STANDARD GLAZING. OPERATING UNITS UTILIZE MULTI-POINT LOCKING HARDWARE FOR DP RATINGS.

Note: Elevations shown DO NOT have exterior trim. Subtract 1/2" (12.7) from M.O. (Masonry Opening) for Unit Size. For other Trim Options refer to the Unit Sizing, Rough Opening & Masonry Openings page.

SCALE: 1/8" = 1'

3-PANEL SECTOR TOP DOORS

M.O. BRICKMOULD
M.O. ADAMS/FLAT CASING
ROUGH OPENING
FRAME SIZE
DAYLIGHT OPENING

97 9/16" [2478]
100 5/8" [2556]
94 9/16" [2402]
93 13/16" [2383]
20 5/8" [524] (3)

103 9/16" [2630]
106 5/8" [2708]
100 9/16" [2554]
99 13/16" [2535]
22 5/8" [575] (3)

115 9/16" [2935]
118 5/8" [3018]
112 9/16" [2859]
111 13/16" [2840]
26 5/8" [676] (3)

83 15/16" [2132]
85 15/32" [2171]
82 9/16" [2097]
81 13/16" [2078]
68 11/16" [1745]

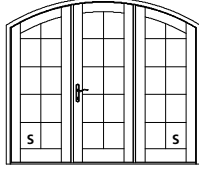

WOSWTS7668

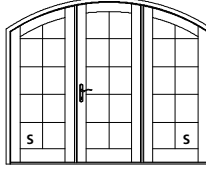

WOSWTS8068

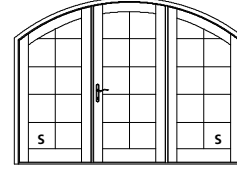

WOSWTS9068

87 15/16" [2234]
89 15/32" [2273]
86 9/16" [2198]
85 13/16" [2180]
72 11/16" [1846]

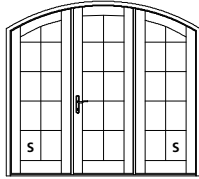

WOSWTS7670

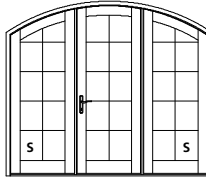

WOSWTS8070

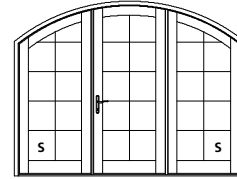

WOSWTS9070

99 15/16" [2538]
101 15/32" [2577]
98 9/16" [2503]
97 13/16" [2484]
84 11/16" [2151]

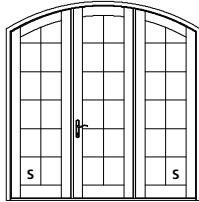

WOSWTS7680

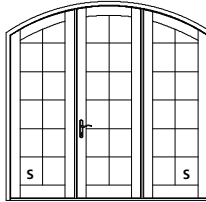

WOSWTS8080

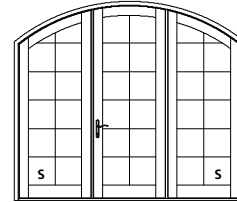

WOSWTS9080

111 15/16" [2843]
113 15/32" [2882]
110 9/16" [2808]
109 13/16" [2789]
96 11/16" [2456]

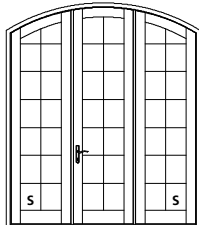

WOSWTS7690

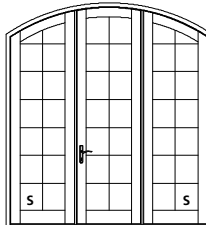

WOSWTS8090

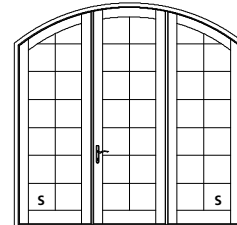

WOSWTS9090

ELEVATION SYMBOL LEGEND:

M.O. = MASONRY OPENING

VALUES IN () ARE IN MILLIMETER CONVERSIONS.

VALUES IN () ARE NUMBER OF DAYLIGHT OPENINGS PER UNIT.

S PANELS AVAILABLE AS STATIONARY ONLY.

Note: Elevations shown DO NOT have exterior trim. Subtract 1/2" (12.7) from M.O. (Masonry Opening) for Unit Size. For other Trim Options refer to the Unit Sizing, Rough Opening & Masonry Openings page.

SCALE: 1/8" = 1'

2-PANEL FRENCH SECTOR TOP DOORS

M.O. BRICKMOULD
M.O. ADAMS/FLAT CASING
ROUGH OPENING
FRAME SIZE
DAYLIGHT OPENING

54 3/8" [1381]
57 7/16" [1459]
51 3/8" [1305]
50 5/8" [1286]
14 5/8" [371] (2)

66 3/8" [1686]
69 7/16" [1764]
63 3/8" [1609]
62 5/8" [1591]
20 5/8" [524] (2)

70 3/8" [1788]
73 7/16" [1865]
67 3/8" [1711]
66 5/8" [1692]
22 5/8" [575] (2)

78 3/8" [1991]
81 7/16" [2069]
75 3/8" [1915]
74 5/8" [1895]
26 5/8" [676] (2)

90 3/8" [2296]
93 7/16" [2373]
87 3/8" [2219]
86 5/8" [2200]
32 5/8" [829] (2)

83 15/16" [2132]
85 15/32" [2171]
82 9/16" [2097]
81 13/16" [2078]
68 11/16" [1745]

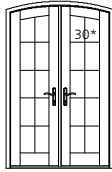

WOFRTS4068

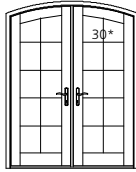

WOFRTS5068

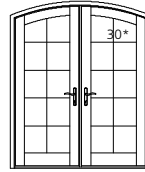

WOFRTS5468

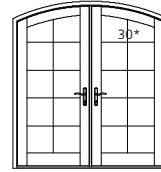

WOFRTS6068

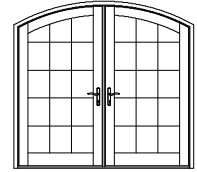

WOFRTS7068

87 15/16" [2234]
89 15/32" [2273]
86 9/16" [2198]
85 13/16" [2180]
72 11/16" [1846]

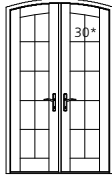

WOFRTS4070

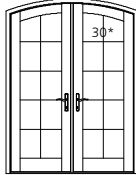

WOFRTS5070

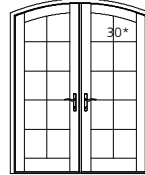

WOFRTS5470

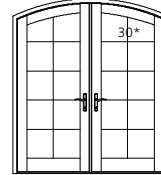

WOFRTS6070

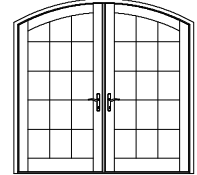

WOFRTS7070

99 15/16" [2538]
101 15/32" [2577]
98 9/16" [2503]
97 13/16" [2484]
84 11/16" [2151]

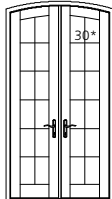

WOFRTS4080

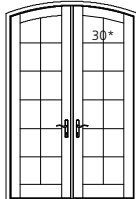

WOFRTS5080

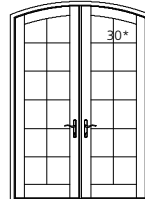

WOFRTS5480

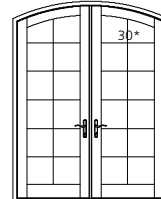

WOFRTS6080

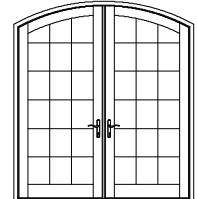

WOFRTS7080

99 15/16" [2538]
101 15/32" [2577]
98 9/16" [2503]
97 13/16" [2484]
84 11/16" [2151]

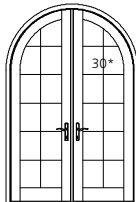

WOFRTH5080

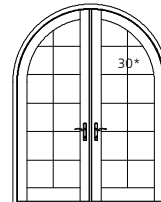

WOFRTH6080

111 15/16" [2843]
113 15/32" [2882]
110 9/16" [2808]
109 13/16" [2789]
96 11/16" [2456]

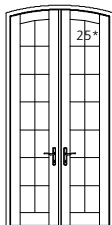

WOFRTS4090

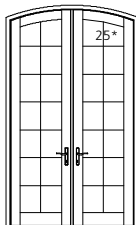

WOFRTS5090

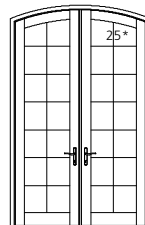

WOFRTS5490

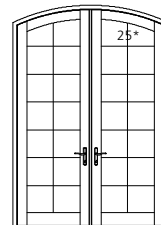

WOFRTS6090

111 15/16" [2843]
113 15/32" [2882]
110 9/16" [2808]
109 13/16" [2789]
96 11/16" [2456]

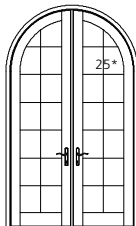

WOFRTH5090

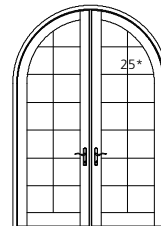

WOFRTH6090

ELEVATION SYMBOL LEGEND:

M.O. = MASONRY OPENING
VALUES IN [] ARE IN MILLIMETER CONVERSIONS.
VALUES IN () ARE NUMBER OF DAYLIGHT OPENINGS PER UNIT.
*** NUMBER INDICATES DESIGN PRESSURE (DP) RATING WITH STANDARD GLAZING. OPERATING UNITS UTILIZE MULTI-POINT LOCKING HARDWARE FOR DP RATINGS.

Note: Elevations shown DO NOT have exterior trim. Subtract 1/2" (12.7) from M.O. (Masonry Opening) for Unit Size. For other Trim Options refer to the Unit Sizing, Rough Opening & Masonry Openings page.

SCALE: 1/8" = 1'

4-PANEL FRENCH SECTOR TOP DOORS

M.O. BRICKMOUND
M.O. ADAMS/FLAT CASING
ROUGH OPENING
FRAME SIZE
DAYLIGHT OPENING

104 3/4" [2661]
107 13/16" [2738]
101 3/4" [2584]
101" [2565]
14 5/8" [371] (4)

128 3/4" [3270]
131 13/16" [3348]
125 3/4" [3194]
125" [3175]
20 5/8" [524] (4)

83 15/16" [2132]
85 15/32" [2171]
82 9/16" [2097]
81 13/16" [2078]
68 11/16" [1745]

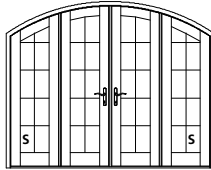

WOFRTS8068

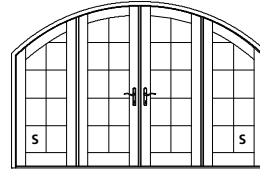

WOFRTS10068

87 15/16" [2234]
89 15/32" [2273]
86 9/16" [2198]
85 13/16" [2180]
72 11/16" [1846]

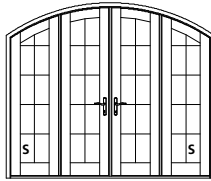

WOFRTS8070

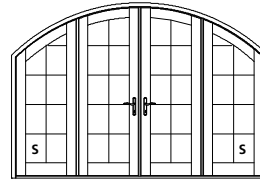

WOFRTS10070

99 15/16" [2538]
101 15/32" [2577]
98 9/16" [2503]
97 13/16" [2484]
84 11/16" [2151]

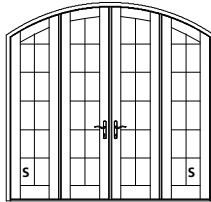

WOFRTS8080

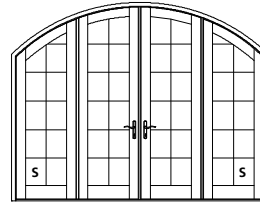

WOFRTS10080

111 15/16" [2843]
113 15/32" [2882]
110 9/16" [2808]
109 13/16" [2789]
96 11/16" [2456]

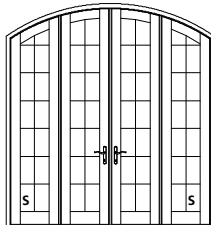

WOFRTS8090

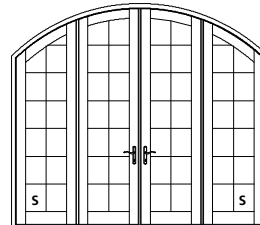

WOFRTS10090

ELEVATION SYMBOL LEGEND:
M.O. = MASONRY OPENING
VALUES IN [] ARE IN MILLIMETER CONVERSIONS.
VALUES IN () ARE NUMBER OF DAYLIGHT OPENINGS PER UNIT.
S PANEL IS AVAILABLE AS STATIONARY ONLY.

Note: Elevations shown DO NOT have exterior trim. Subtract 1/2" (12.7) from M.O. (Masonry Opening) for Unit Size. For other Trim Options refer to the Unit Sizing, Rough Opening & Masonry Openings page.

SCALE: 1/8" = 1'

FRENCH SECTOR TOP DOORS WITH TWO SIDELITES
5-0 UNITS

M.O. BRICKMOUND
M.O. ADAMS/FLAT CASING
ROUGH OPENING
FRAME SIZE
DAYLIGHT OPENING

93" [2362]
96 1/16" [2440]
90" [2286]
89 1/4" [2267]
20 5/8" [524] (2) - 7 1/2" [190] (2)

97" [2464]
100 1/16" [2542]
94" [2387]
93 1/4" [2369]
20 5/8" [524] (2) - 9 1/2" [241] (2)

101" [2565]
104 1/16" [2643]
98" [2489]
97 1/4" [2470]
20 5/8" [524] (2) - 11 1/2" [292] (2)

83 15/16" [2132]
85 15/32" [2171]
82 9/16" [2097]
81 13/16" [2078]
68 11/16" [1745]

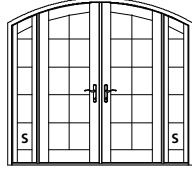

WOFRTS5068Q10

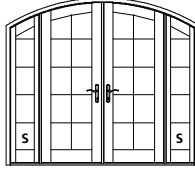

WOFRTS5068Q12

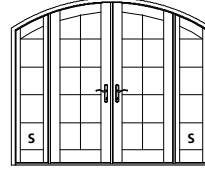

WOFRTS5068Q14

87 15/16" [2234]
89 15/32" [2273]
86 9/16" [2198]
85 13/16" [2180]
72 11/16" [1846]

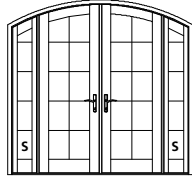

WOFRTS5070Q10

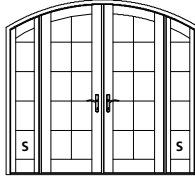

WOFRTS5070Q12

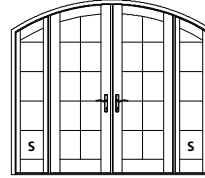

WOFRTS5070Q14

99 15/16" [2538]
101 15/32" [2577]
98 9/16" [2503]
97 13/16" [2484]
84 11/16" [2151]

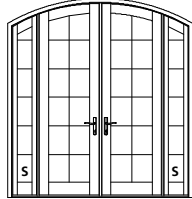

WOFRTS5080Q10

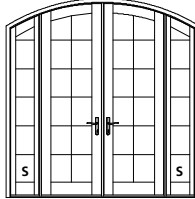

WOFRTS5080Q12

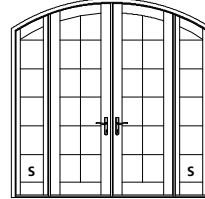

WOFRTS5080Q14

111 15/16" [2843]
113 15/32" [2882]
110 9/16" [2808]
109 13/16" [2789]
96 11/16" [2456]

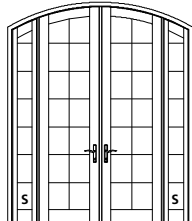

WOFRTS5090Q10

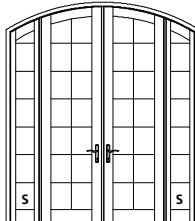

WOFRTS5090Q12

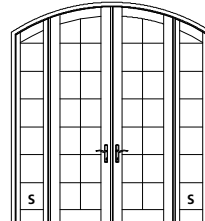

WOFRTS5090Q14

ELEVATION SYMBOL LEGEND:

M.O. = MASONRY OPENING
VALUES IN [] ARE IN MILLIMETER CONVERSIONS.
VALUES IN () ARE NUMBER OF DAYLIGHT OPENINGS PER UNIT.
S = PANEL IS AVAILABLE AS STATIONARY ONLY.

Note: Elevations shown DO NOT have exterior trim. Subtract 1/2" (12.7) from M.O. (Masonry Opening) for Unit Size. For other Trim Options refer to the Unit Sizing, Rough Opening & Masonry Openings page.

SCALE: 1/8" = 1'

FRENCH SECTOR TOP DOORS WITH TWO SIDELITES
5-4 UNITS

M.O. BRICKMOULD
M.O. ADAMS/FLAT CASING
ROUGH OPENING
FRAME SIZE
DAYLIGHT OPENING

97" [2464]
100 1/16" [2542]
94" [2387]
93 1/4" [2369]
22 5/8" [575] (2) - 7 1/2" [190] (2)

101" [2565]
104 1/16" [2643]
98" [2489]
97 1/4" [2470]
22 5/8" [575] (2) - 9 1/2" [241] (2)

105" [2667]
108 1/16" [2745]
102" [2590]
101 1/4" [2572]
22 5/8" [575] (2) - 11 1/2" [292] (2)

83 15/16" [2132]
85 13/32" [2171]
82 9/16" [2097]
81 13/16" [2078]
68 11/16" [1745]

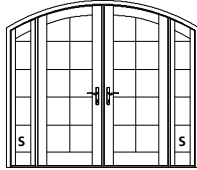

WOFRTS5468Q10

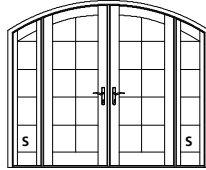

WOFRTS5468Q12

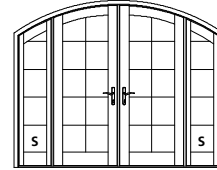

WOFRTS5468Q14

87 15/16" [2234]
89 13/32" [2273]
86 9/16" [2199]
85 13/16" [2180]
72 11/16" [1846]

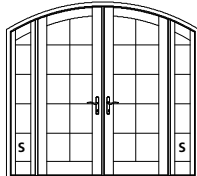

WOFRTS5470Q10

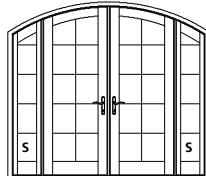

WOFRTS5470Q12

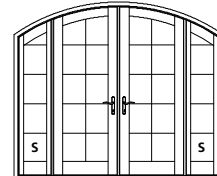

WOFRTS5470Q14

99 15/16" [2538]
101 13/32" [2577]
98 9/16" [2503]
97 13/16" [2484]
84 11/16" [2151]

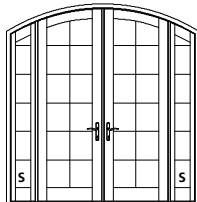

WOFRTS5480Q10

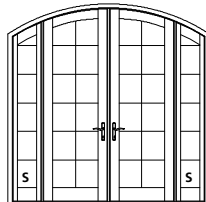

WOFRTS5480Q12

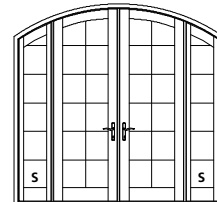

WOFRTS5480Q14

111 15/16" [2843]
113 15/32" [2882]
110 9/16" [2808]
109 13/16" [2789]
96 11/16" [2456]

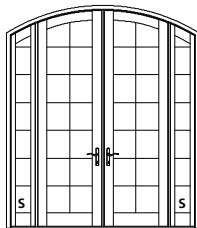

WOFRTS5490Q10

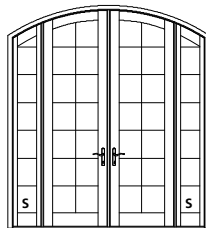

WOFRTS5490Q12

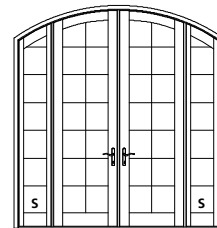

WOFRTS5490Q14

ELEVATION SYMBOL LEGEND:

M.O. = MASONRY OPENING
VALUES IN [] ARE IN MILLIMETER CONVERSIONS.
VALUES IN () ARE NUMBER OF DAYLIGHT OPENINGS PER UNIT.
S PANELS AVAILABLE AS STATIONARY ONLY.

Note: Elevations shown DO NOT have exterior trim. Subtract 1/2" (12.7) from M.O. (Masonry Opening) for Unit Size. For other Trim Options refer to the Unit Sizing, Rough Opening & Masonry Openings page.

SCALE: 1/8" = 1'

FRENCH SECTOR TOP DOORS WITH TWO SIDELITES
6-0 UNITS

M.O. BRICKMOUND
M.O. ADAMS/FLAT CASING
ROUGH OPENING
FRAME SIZE
DAYLIGHT OPENING

105" [2667]
108 1/16" [2745]
102" [2591]
101 1/4" [2572]
26 5/8" [676] (2) - 7 1/2" [190] (2)

109" [2769]
112 1/16" [2846]
106" [2692]
105 1/4" [2673]
26 5/8" [676] (2) - 9 1/2" [241] (2)

113" [2870]
116 1/16" [2946]
110" [2794]
109 1/4" [2775]
26 5/8" [676] (2) - 11 1/2" [292] (2)

83 15/16" [2132]
85 15/32" [2171]
82 9/16" [2097]
81 13/16" [2078]
68 11/16" [1745]

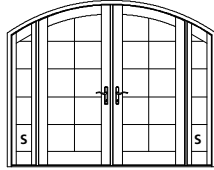

WOFRTS6068Q10

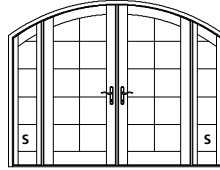

WOFRTS6068Q12

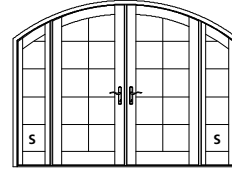

WOFRTS6068Q14

87 15/16" [2234]
89 15/32" [2273]
86 9/16" [2198]
85 13/16" [2180]
72 11/16" [1846]

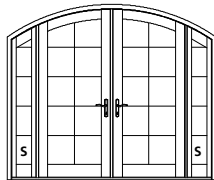

WOFRTS6070Q10

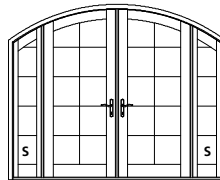

WOFRTS6070Q12

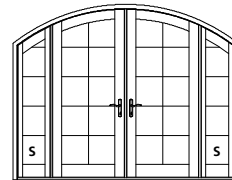

WOFRTS6070Q14

99 15/16" [2538]
101 15/32" [2577]
98 9/16" [2503]
97 13/16" [2484]
84 11/16" [2151]

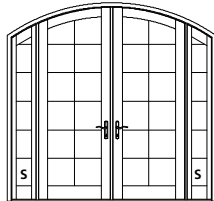

WOFRTS6080Q10

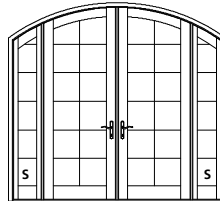

WOFRTS6080Q12

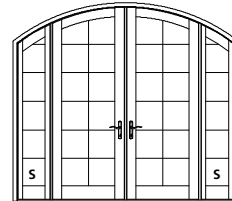

WOFRTS6080Q14

111 15/16" [2843]
113 15/32" [2882]
110 9/16" [2808]
109 13/16" [2789]
96 11/16" [2456]

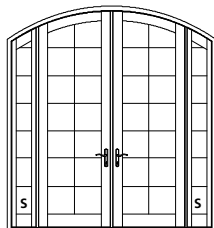

WOFRTS6090Q10

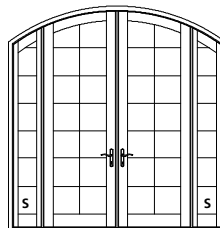

WOFRTS6090Q12

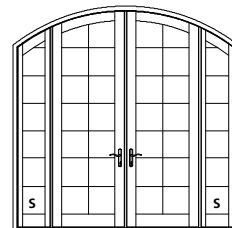

WOFRTS6090Q14

ELEVATION SYMBOL LEGEND:

M.O. = MASONRY OPENING
VALUES IN [] ARE IN MILLIMETER CONVERSIONS.
VALUES IN () ARE NUMBER OF DAYLIGHT OPENINGS PER UNIT.
S PANEL IS AVAILABLE AS STATIONARY ONLY.

Note: Elevations shown DO NOT have exterior trim. Subtract 1/2" (12.7) from M.O. (Masonry Opening) for Unit Size. For other Trim Options refer to the Unit Sizing, Rough Opening & Masonry Openings page.

SCALE: 1/8" = 1'

FRENCH SECTOR TOP DOORS WITH TWO SIDELITES
7-0 UNITS

M.O. BRICKMOUND
M.O. ADAMS/FLAT CASING
ROUGH OPENING
FRAME SIZE
DAYLIGHT OPENING

117" [2972]
120 1/16" [3050]
114" [2895]
113 1/4" [2877]
32 5/8" [829] (2) - 7 1/2" [190] (2)

121" [3073]
124 1/16" [3151]
118" [2997]
117 1/4" [2978]
32 5/8" [829] (2) - 9 1/2" [241] (2)

125" [3175]
128 1/16" [3253]
122" [3098]
121 1/4" [3080]
32 5/8" [829] (2) - 11 1/2" [292] (2)

83 15/16" [2132]
85 15/32" [2171]
82 9/16" [2097]
81 13/16" [2078]
68 11/16" [1745]

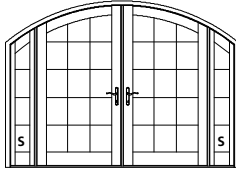

WOFRTS7068Q10

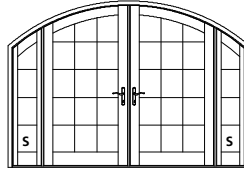

WOFRTS7068Q12

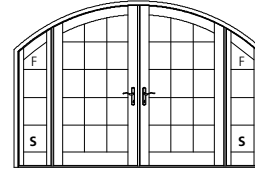

WOFRTS7068Q14

87 15/16" [2234]
89 15/32" [2273]
86 9/16" [2198]
85 13/16" [2180]
72 11/16" [1846]

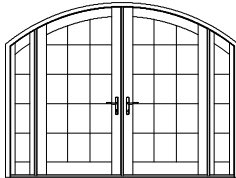

WOFRTS7070Q10

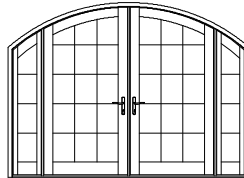

WOFRTS7070Q12

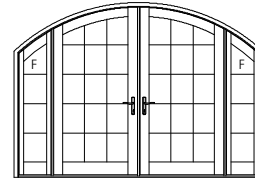

WOFRTS7070Q14

99 15/16" [2538]
101 15/32" [2577]
98 9/16" [2503]
97 13/16" [2484]
84 11/16" [2151]

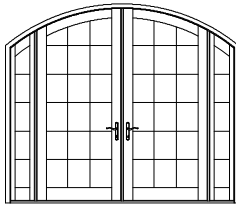

WOFRTS7080Q10

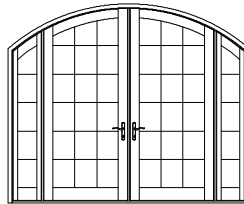

WOFRTS7080Q12

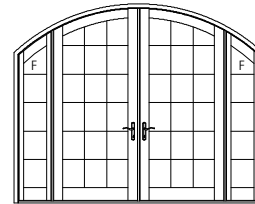

WOFRTS7080Q14

ELEVATION SYMBOL LEGEND:

M.O. = MASONRY OPENING
VALUES IN [] ARE IN MILLIMETER CONVERSIONS.
VALUES IN () ARE NUMBER OF DAYLIGHT OPENINGS PER UNIT.
S PANEL IS AVAILABLE AS STATIONARY ONLY.

Note: Elevations shown DO NOT have exterior trim. Subtract 1/2" (12.7) from M.O. (Masonry Opening) for Unit Size. For other Trim Options refer to the Unit Sizing, Rough Opening & Masonry Openings page.

SECTOR TOP TRANSOM UNITS

M.O. BRICKMOULD
M.O. ADAMS/FLAT CASING
ROUGH OPENING
FRAME SIZE
DAYLIGHT OPENING

29 3/16" [741]
32 1/4" [819]
26 3/16" [665]
25 7/16" [646]
14 5/8" [371]

35 3/16" [894]
38 1/4" [972]
32 3/16" [818]
31 7/16" [799]
20 5/8" [551]

37 3/16" [945]
40 1/4" [1022]
34 3/16" [868]
33 7/16" [849]
22 5/8" [575]

41 3/16" [1046]
44 1/4" [1124]
38 3/16" [970]
37 7/16" [951]
26 5/8" [676]

23 3/4" [603]
26 13/16" [681]
20 3/4" [528]
20" [508]
14 1/16" [357]



WTOSWTS2018



WTOSWTS2618



WTOSWTS2818



WTOSWTS3018

33 3/4" [857]
36 13/16" [935]
30 3/4" [781]
30" [762]
24 1/16" [611]



WTOSWTS2026



WTOSWTS2626



WTOSWTS2826



WTOSWTS3026

M.O. BRICKMOULD
M.O. ADAMS/FLAT CASING
ROUGH OPENING
FRAME SIZE
DAYLIGHT OPENING

54 3/8" [1381]
57 7/16" [1459]
51 3/8" [1305]
50 5/8" [1286]
39 13/16" [1011]

66 3/8" [1686]
69 7/16" [1764]
63 3/8" [1609]
62 5/8" [1591]
51 13/16" [1316]

70 3/8" [1788]
73 7/16" [1865]
67 3/8" [1711]
66 5/8" [1692]
55 13/16" [1418]

78 3/8" [1991]
81 7/16" [2069]
75 3/8" [1914]
74 5/8" [1895]
63 13/16" [1621]

23 3/4" [603]
26 13/16" [681]
20 3/4" [528]
20" [508]
14 1/16" [357]

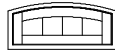

WTOFRTS4018



WTOFRTS5018



WTOFRTS5418



WTOFRTS6018

33 3/4" [857]
36 13/16" [935]
30 3/4" [781]
30" [762]
24 1/16" [611]

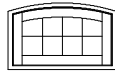

WTOFRTS4026

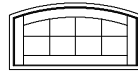

WTOFRTS5026

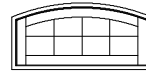

WTOFRTS5426

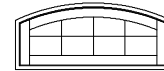

WTOFRTS6026

ELEVATION SYMBOL LEGEND:

M.O. = MASONRY OPENING
VALUES IN [] ARE IN MILLIMETER CONVERSIONS.

Note: Elevations shown DO NOT have exterior trim. Subtract 1/2" (12.7) from M.O. (Masonry Opening) for Unit Size. For other Trim Options refer to the Unit Sizing, Rough Opening & Masonry Openings page.

GLAZING OPTIONS

INTERIOR GLAZED
INSULATED 3/4" [19] GLASS

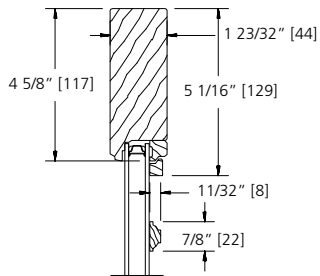

7/8" GRILLE BAR

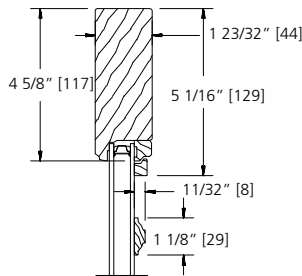

1 1/8" GRILLE BAR

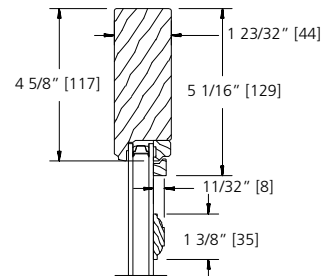

1 3/8" GRILLE BAR

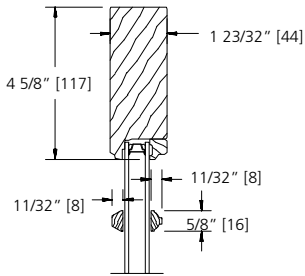

**5/8" SDL BAR
(PUTTY/BEAD)**

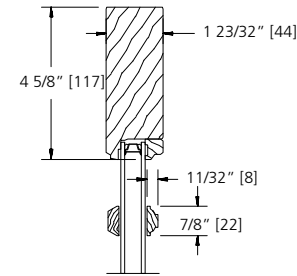

**7/8" SDL BAR
(PUTTY/BEAD)**

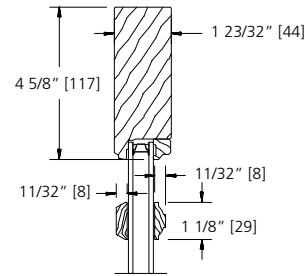

**1 1/8" SDL BAR
(PUTTY/BEAD)**

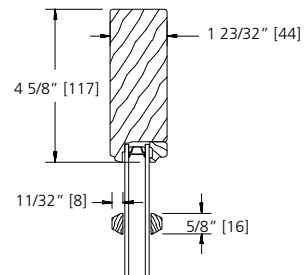

**5/8" SDL BAR
(PUTTY/PUTTY)**

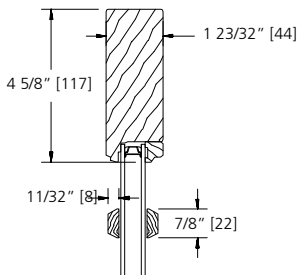

**7/8" SDL BAR
(PUTTY/PUTTY)**

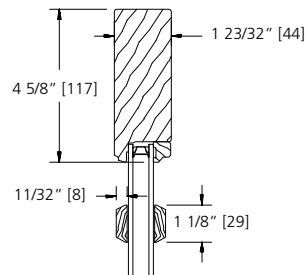

**1 1/8" SDL BAR
(PUTTY/PUTTY)**

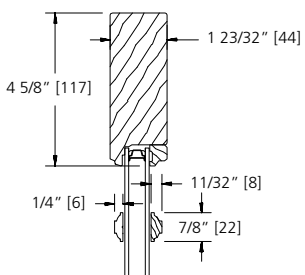

**7/8" SDL BAR
(BEAD STOP)**

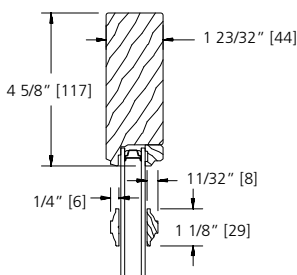

**1 1/8" SDL BAR
(BEAD STOP)**

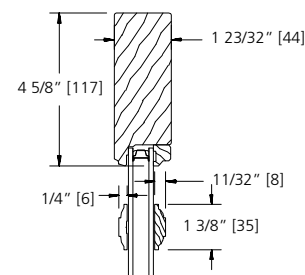

**1 3/8" SDL BAR
(BEAD STOP)**

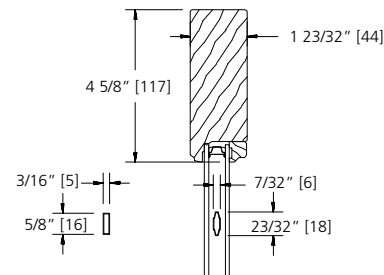

5/8" FLAT GBG

23/32" CONTOUR GBG

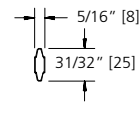

1" CONTOUR GBG

SCALE: NTS

GLAZING OPTIONS

INTERIOR GLAZED
SINGLE 1/8" [3] GLASS

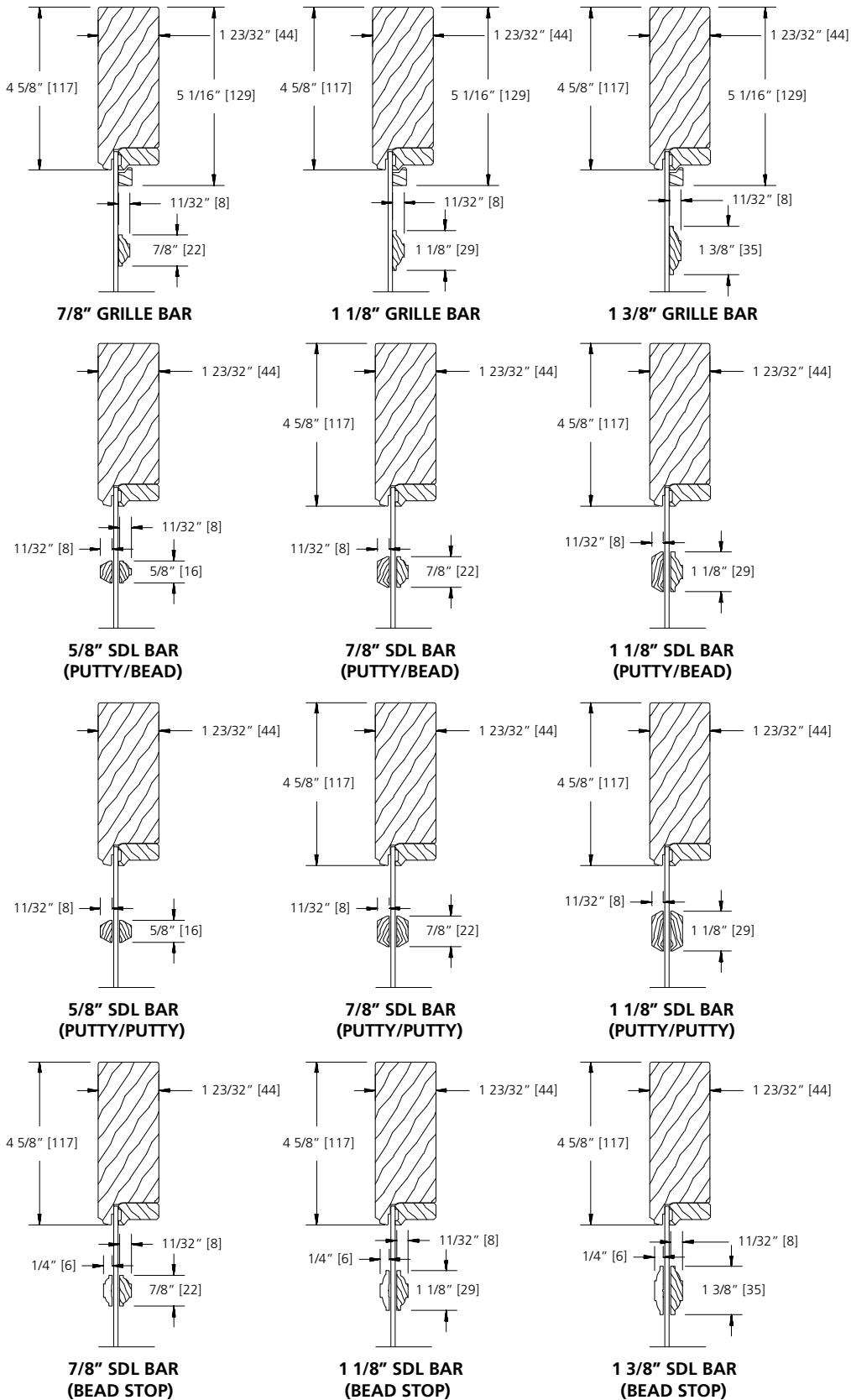

SCALE: NTS

GLAZING OPTIONS

**INTERIOR GLAZED
IMPACT RESISTANT GLASS**

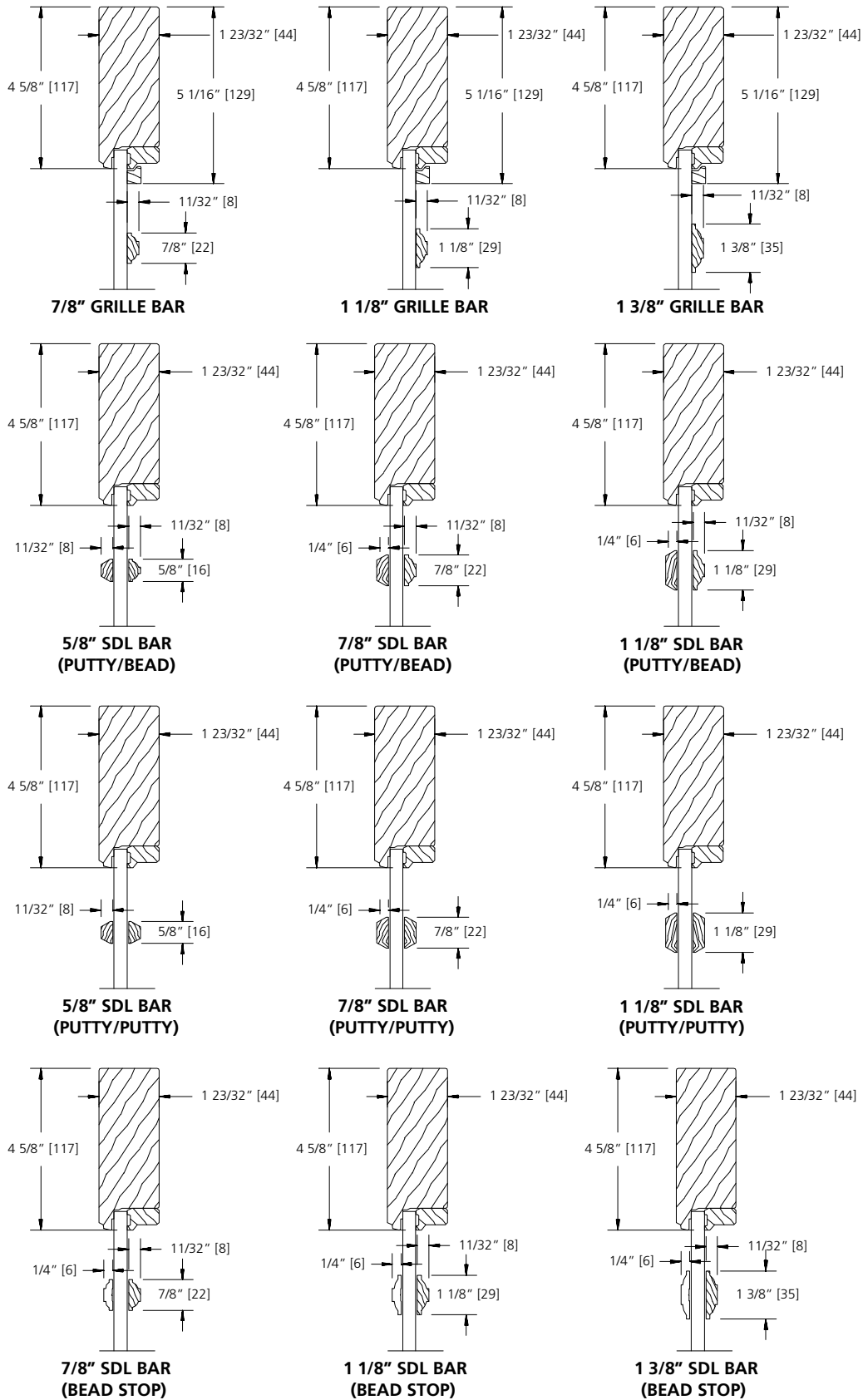

SCALE: NTS

GLAZING OPTIONS

EXTERIOR GLAZED

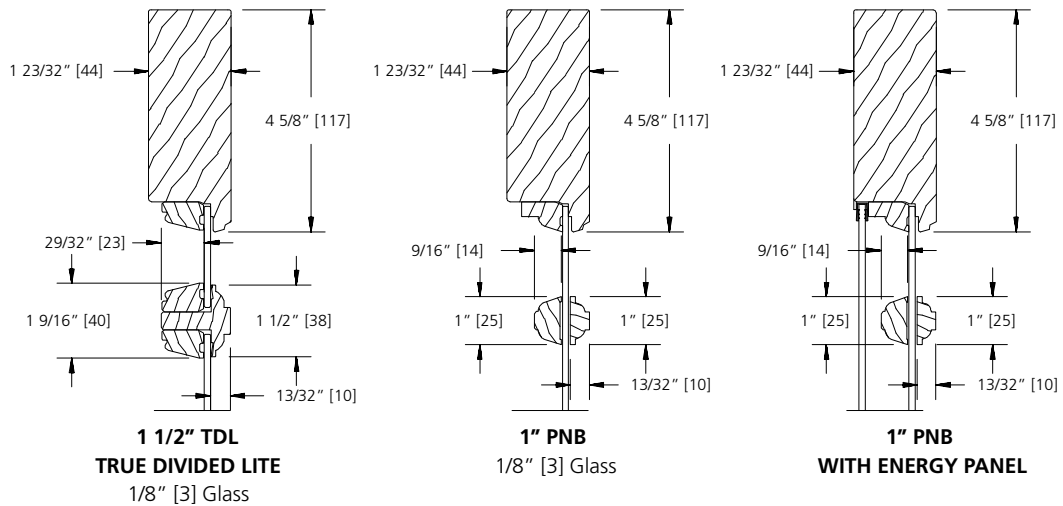
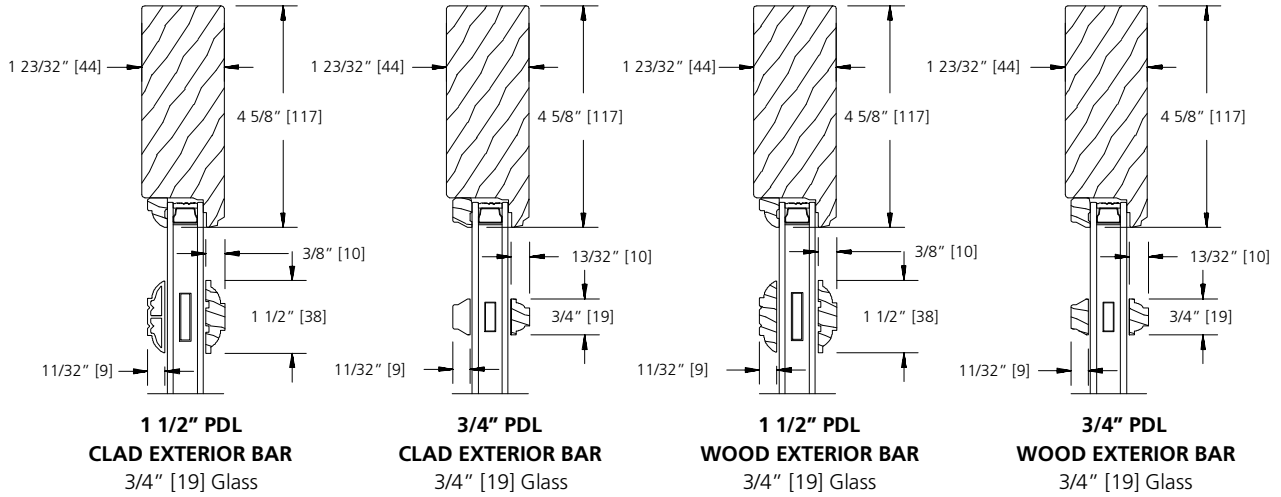

SCALE: NTS

TRIM OPTIONS

EXTERIOR TRIM

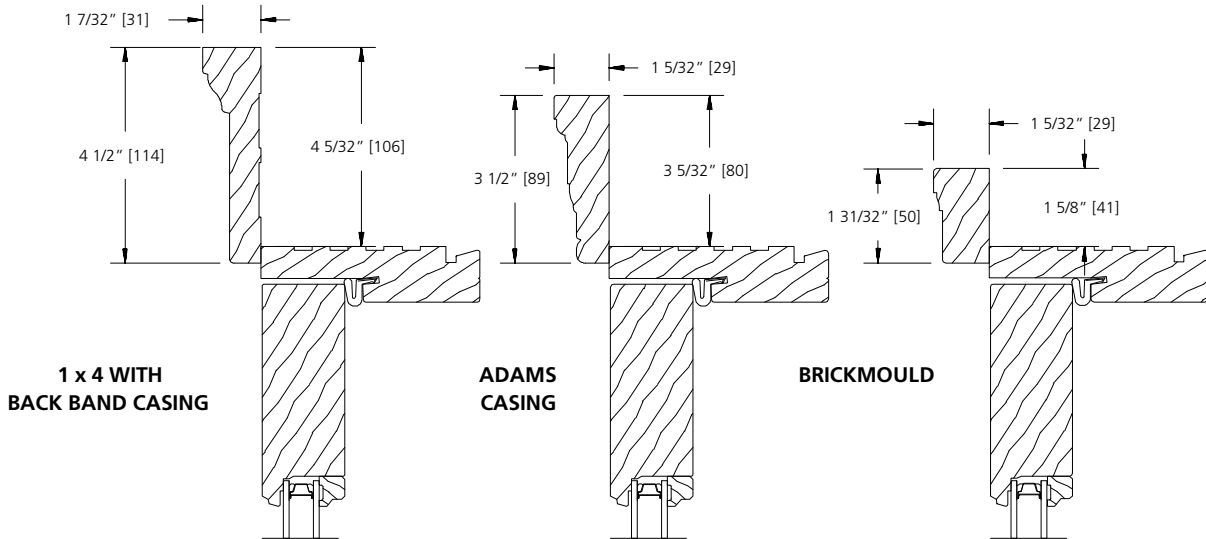
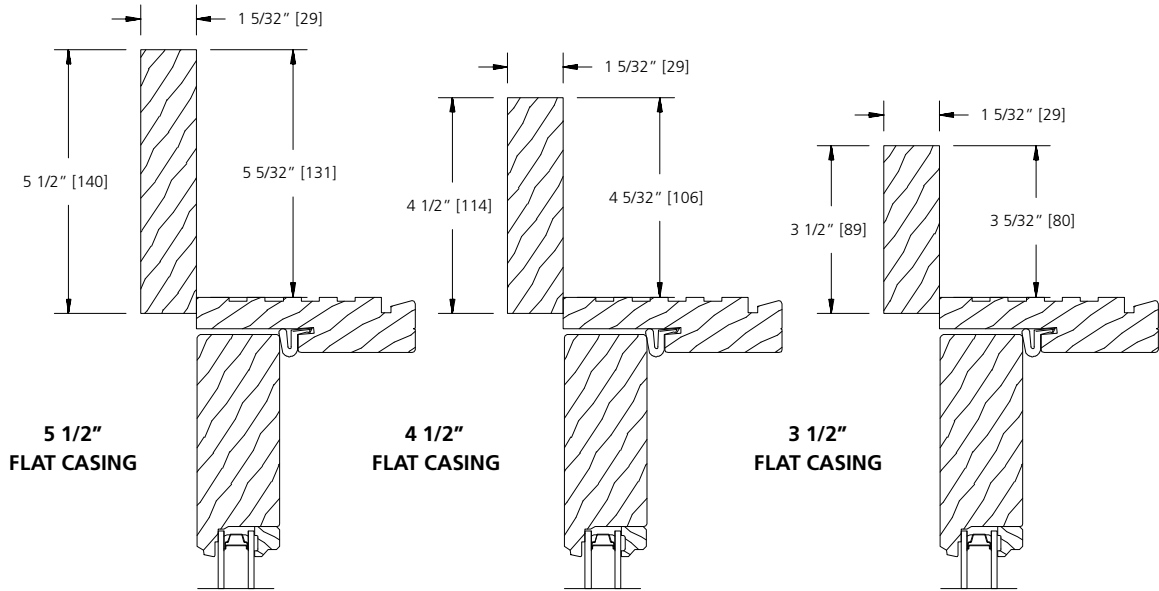

STUCCO EXTERIOR TRIM

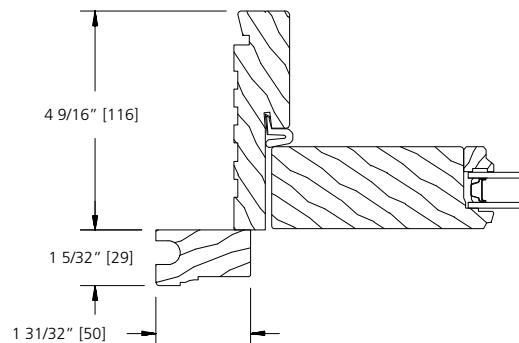

SCALE: 3" = 1'

RAIL, PANEL & SILL OPTIONS

JAMB EXTENDER & TRANSOM SILL OPTIONS

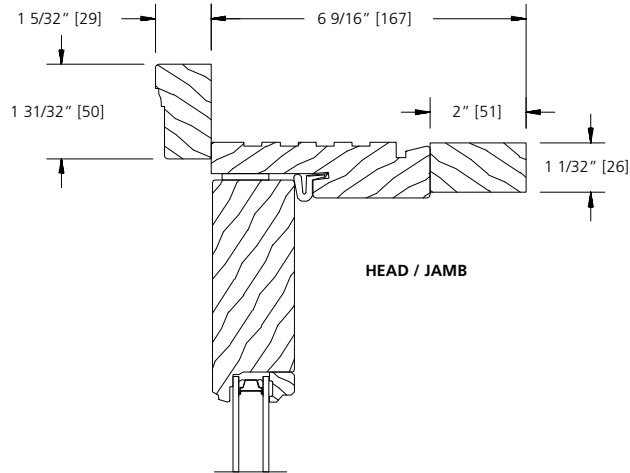

**2" OPTIONAL WOOD
JAMB EXTENDER (6 9/16" JAMB)**

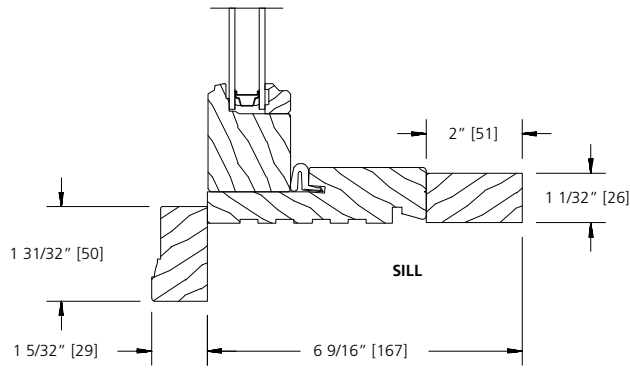

**2" OPTIONAL TRANSOM
SILL EXTENDER (6 9/16" JAMB)**

SCALE: 3" = 1'

RAIL, PANEL & SILL OPTIONS

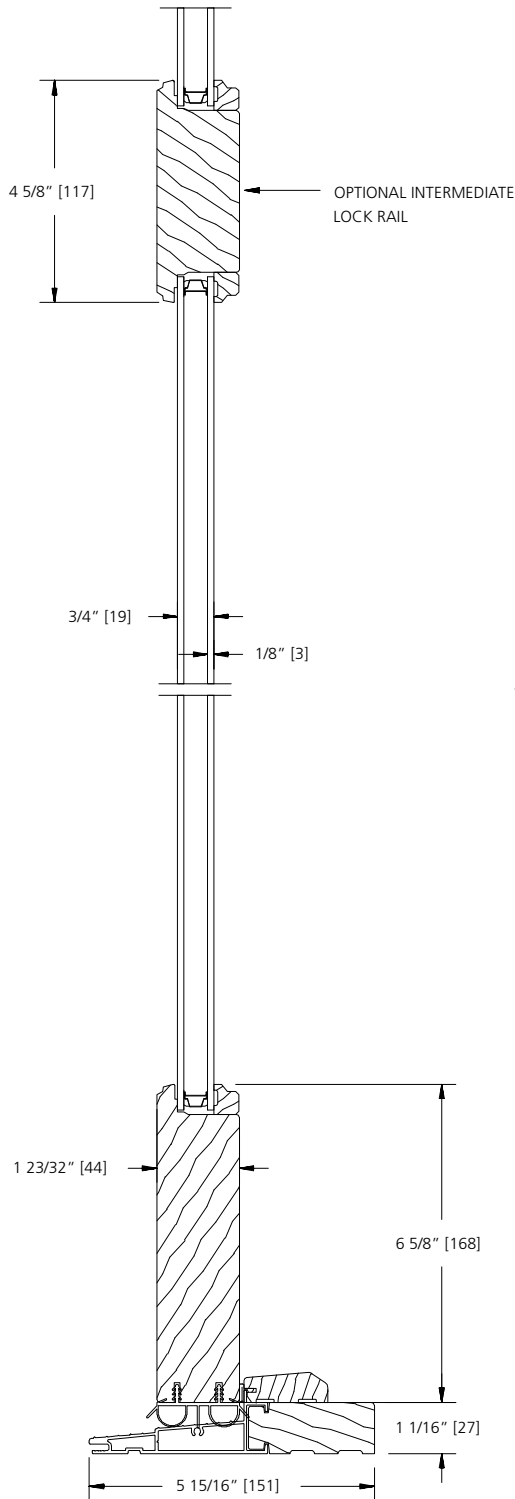

STANDARD 6 5/8\" BOTTOM RAIL
STANDARD SILL (4 9/16\" / 6 9/16\" JAMB)

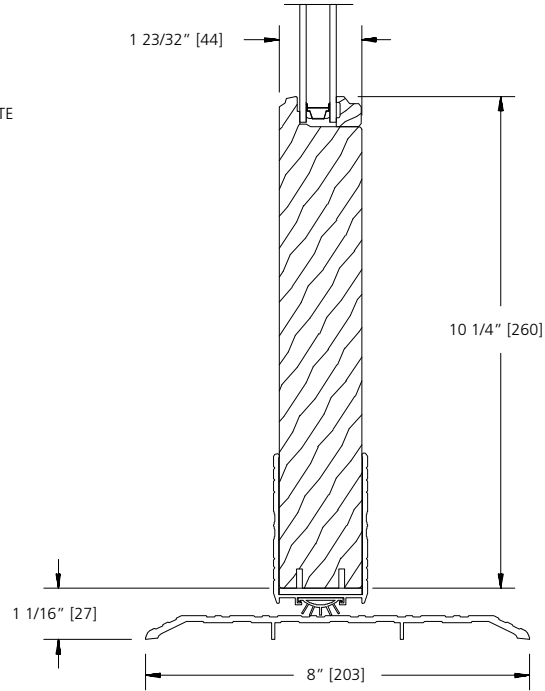

OPTIONAL 10 1/4\" BOTTOM RAIL
HANDICAP SILL (4 9/16\" JAMB)

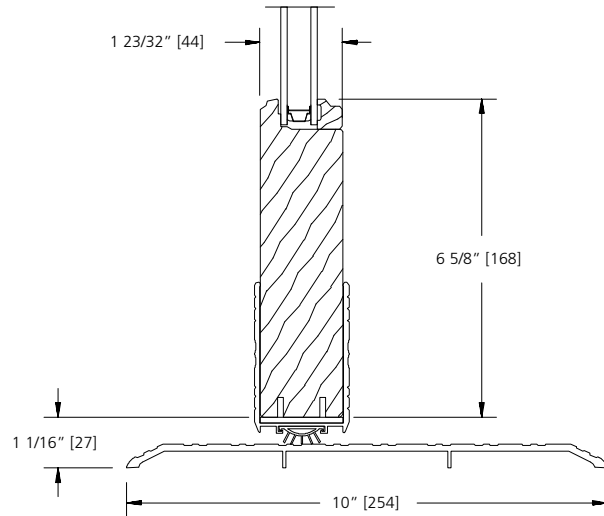

STANDARD 6 5/8\" BOTTOM RAIL
HANDICAP SILL (6 9/16\" JAMB)

SCALE: 3" = 1'

RAIL, PANEL & SILL OPTIONS

STANDARD RAISED PANEL OPTIONS

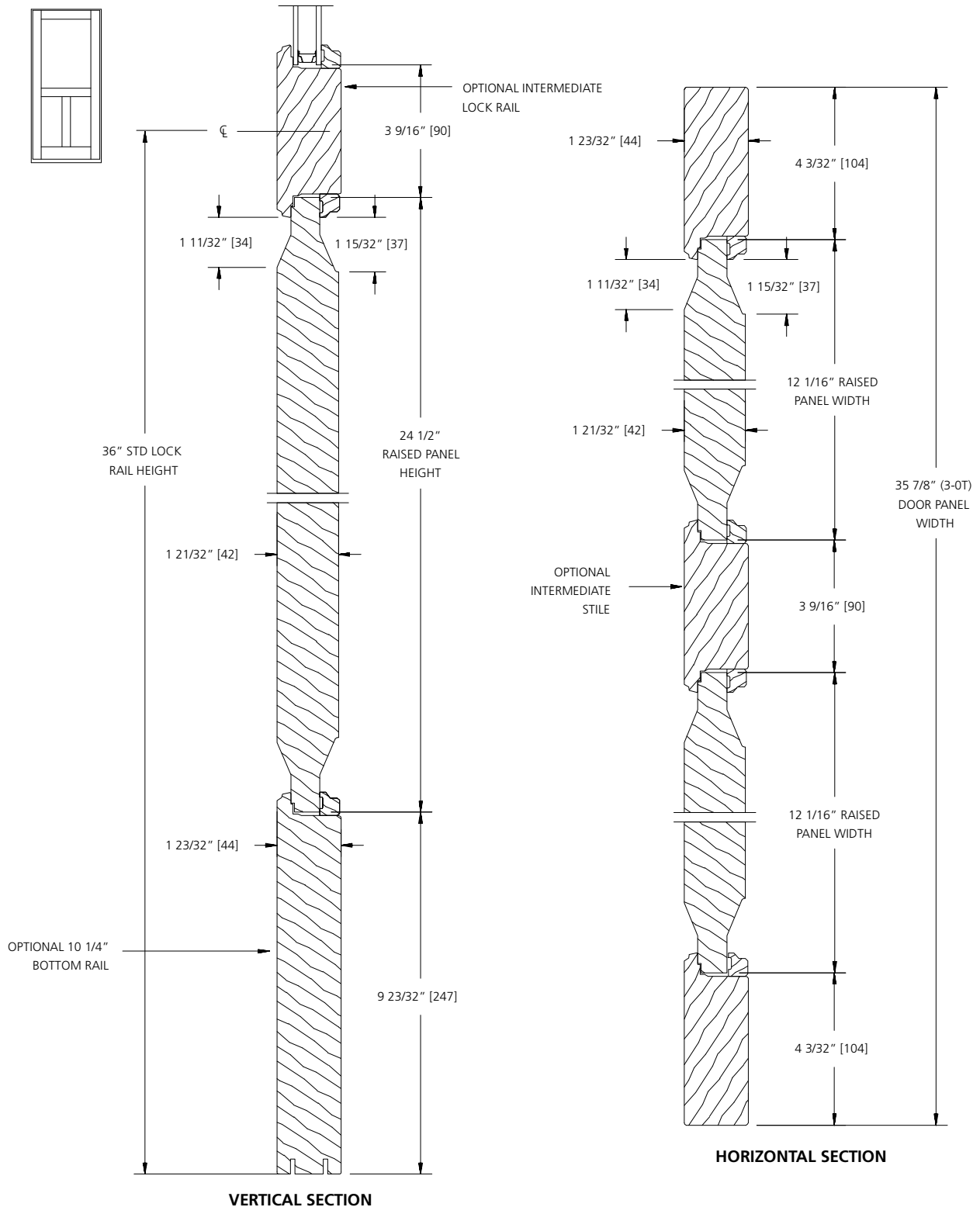

SCALE: 3" = 1'

RAIL, PANEL & SILL OPTIONS

OPTIONAL RAISED PANEL OPTIONS

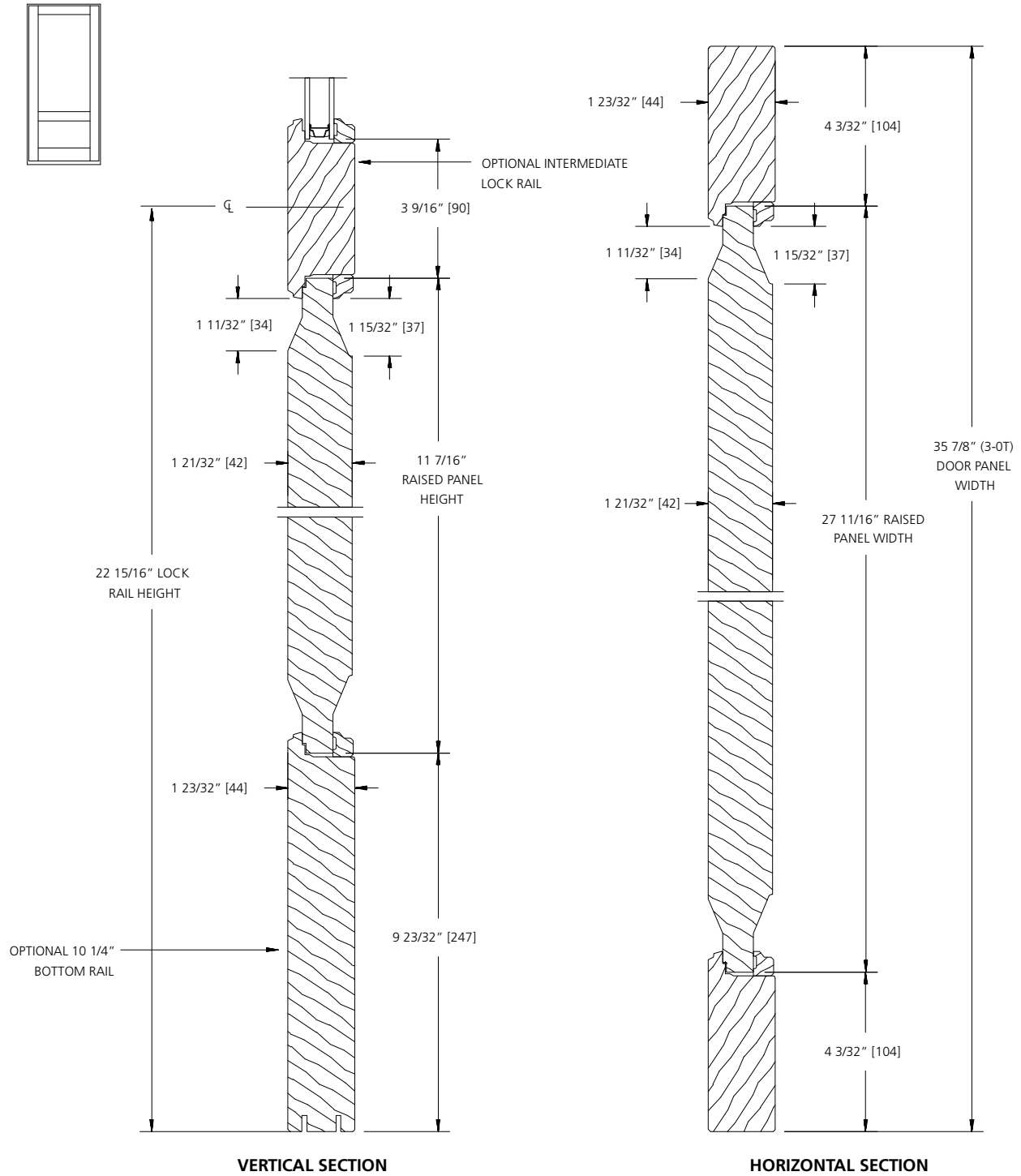

SCALE: 3" = 1'

STANDARD MULLION DETAILS

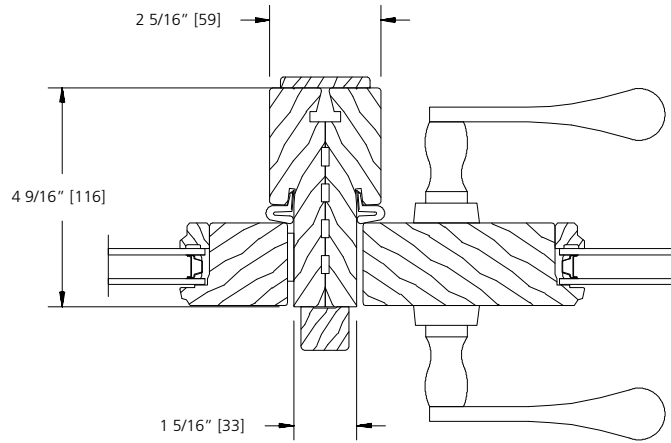

SIDE JAMB

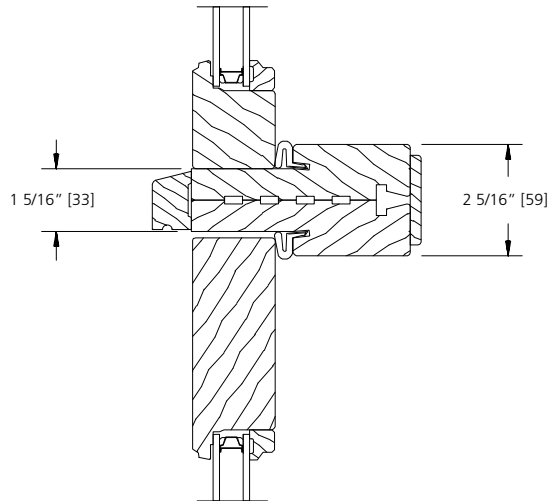

HEAD / TRANSOM SILL

LITE CUT INFORMATION

Wood out-swing patio doors are available with removable grilles in 5/8", 7/8", 1-1/8", and 1-3/8" widths, with GBG (Grilles between the Glass), or with Simulated Divided Lites. Standard lite cuts are rectangular.

LITE CUT OPTIONS

Special lite cut patterns can include a wide variety of straight line and radius patterns. The illustrations shown here represent just a few of the possibilities. Rectangular, horizontal, vertical and Prairie lite patterns are available in all standard size wood swinging patio doors. Uneven, diamond, radius and Gothic lite cuts are available, subject to approval. Approvals are based on the ability to fulfill the design requirement while maintaining the construction integrity of the finished product.

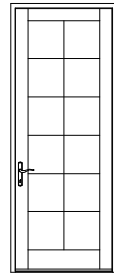

RECTANGULAR

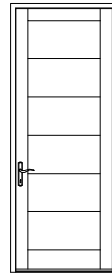

HORIZONTAL

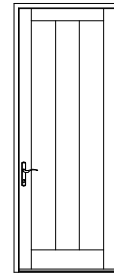

VERTICAL

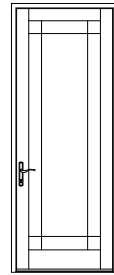

PRAIRIE

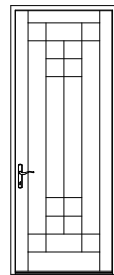

UNEVEN

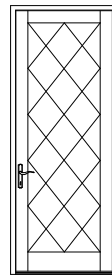

DIAMOND

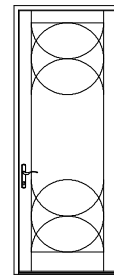

RADIUS

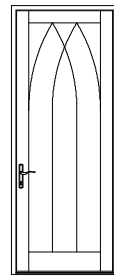

GOthic

BAR ALIGNMENT

Alignment of divided lite muntin bars from one product to the next is often required by fine architectural design. Wood grilles, GBG (Grilles between the Glass), and Simulated Divided Lites may be specified with muntin bars aligned.

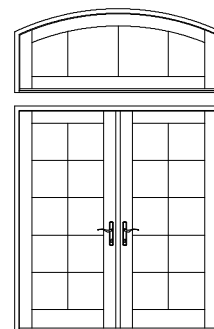
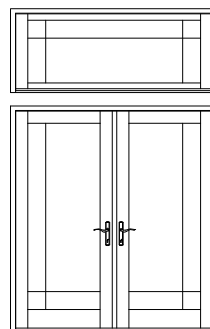

**UNIT SIZING, ROUGH OPENINGS
& MASONRY OPENINGS**

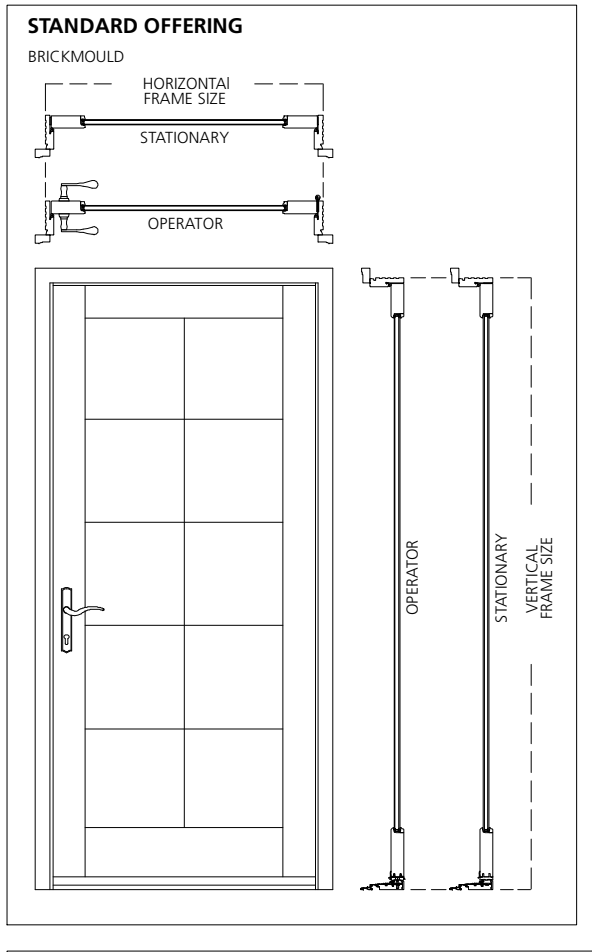

GENERAL NOTES:

UNITS WITH NO EXTERIOR TRIM
FRAME SIZE = UNIT SIZE

UNIT SIZE IS ALWAYS THE
EXTREME SIZE OF THE DOOR
WITH OR WITHOUT TRIM

ROUGH OPENING IS ALWAYS 3/4" OVER
FRAME SIZE OF THE DOOR

MASONRY OPENING IS ALWAYS 1/2"
OVER THE UNIT SIZE OF THE DOOR

ROUGH OPENING:

BRICKMOULD

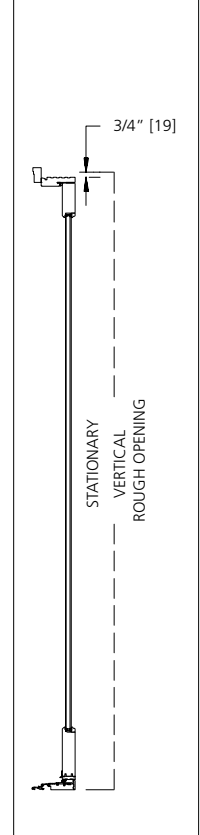
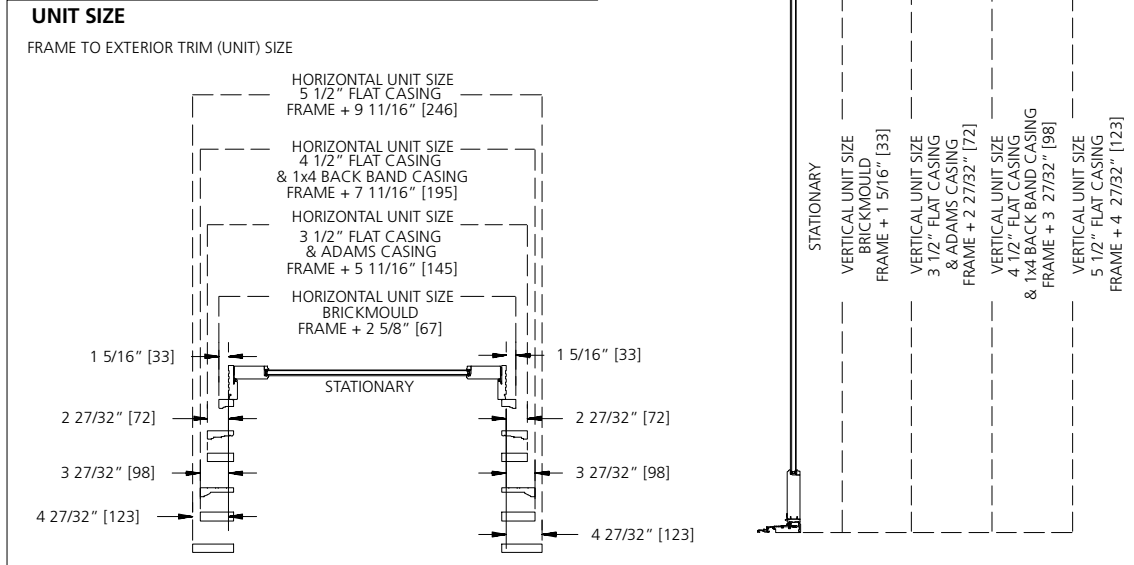
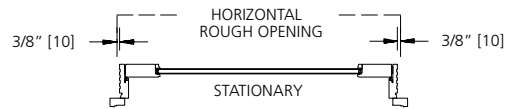

1-PANEL OPERATING UNIT

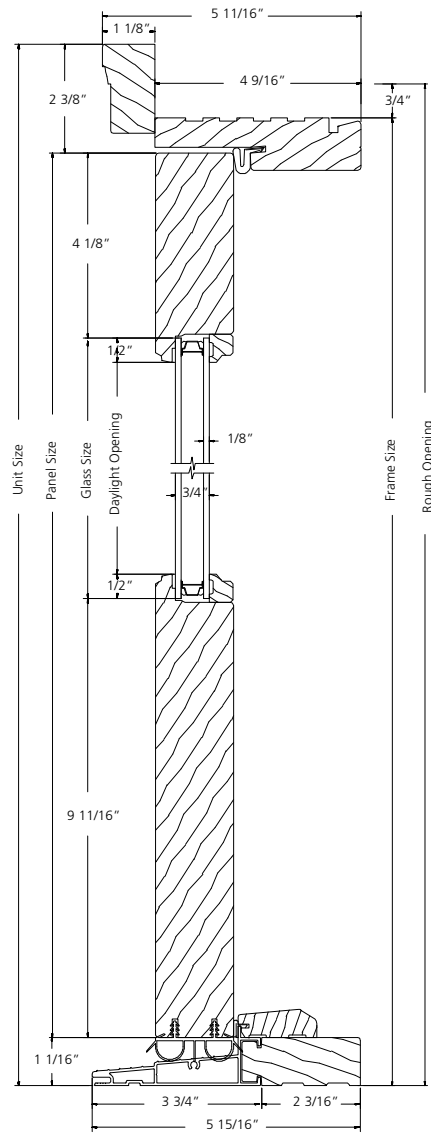

VERTICAL SECTION

SCALE: 3" = 1'

1-PANEL OPERATING UNIT

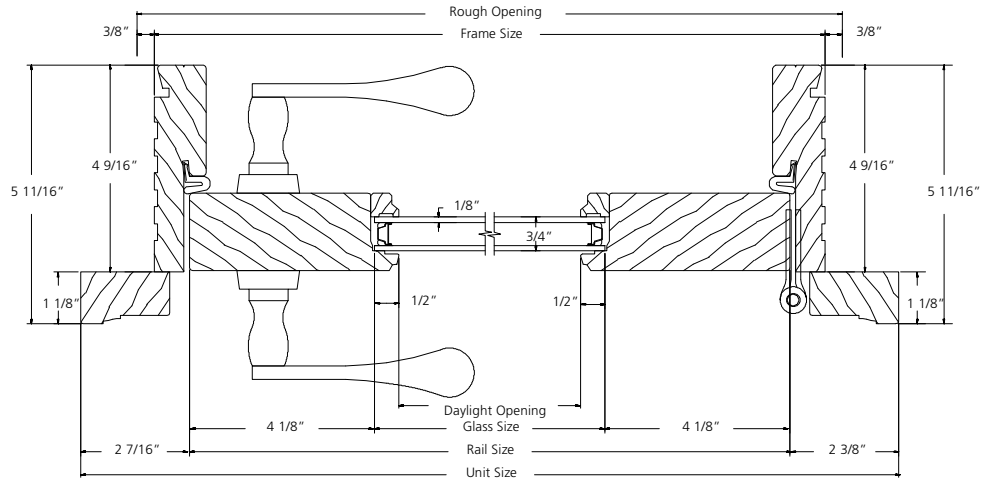

HORIZONTAL SECTION

SCALE: 3" = 1'

2-PANEL UNIT

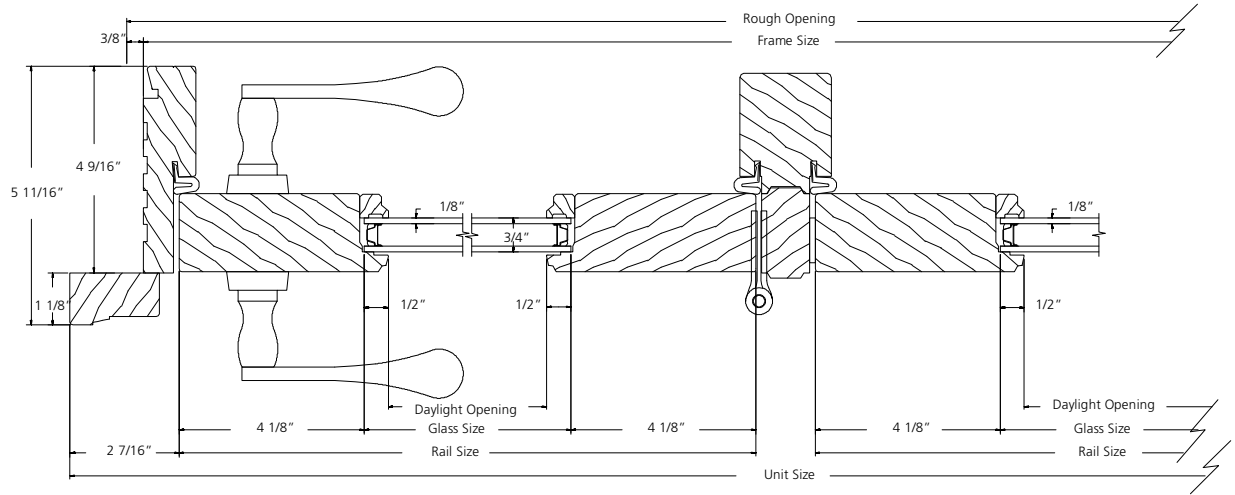

HORIZONTAL SECTION

SCALE: 3" = 1'

3-PANEL UNIT

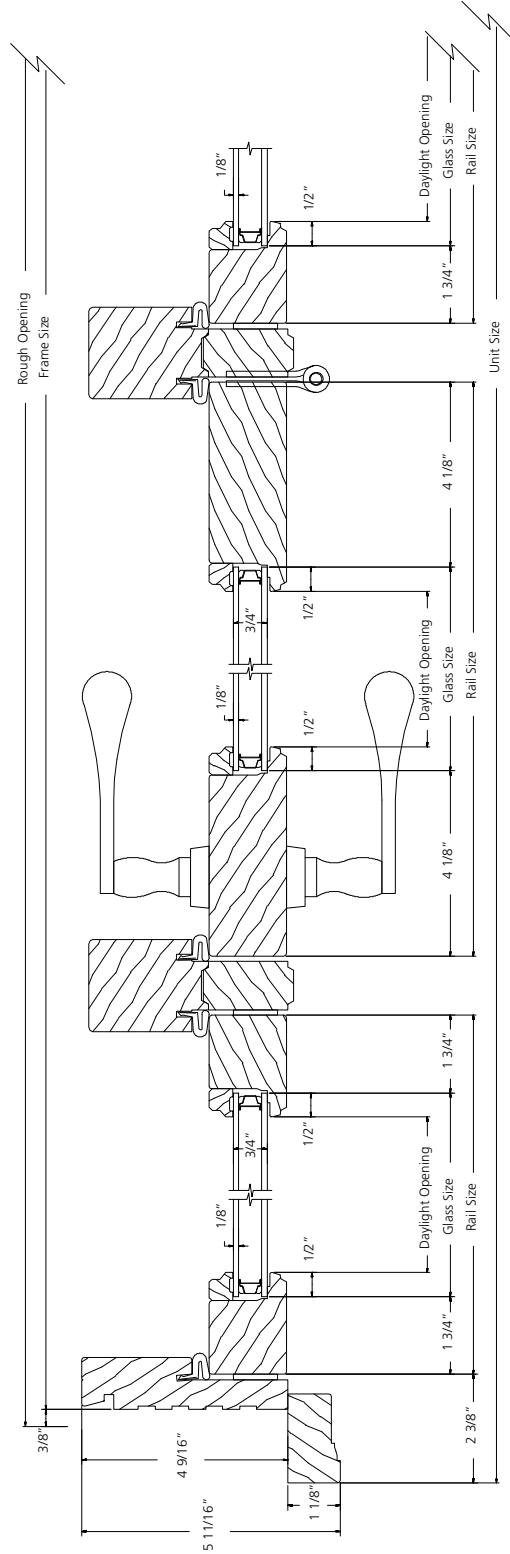

HORIZONTAL SECTION

SCALE: 3" = 1'

4-PANEL UNIT

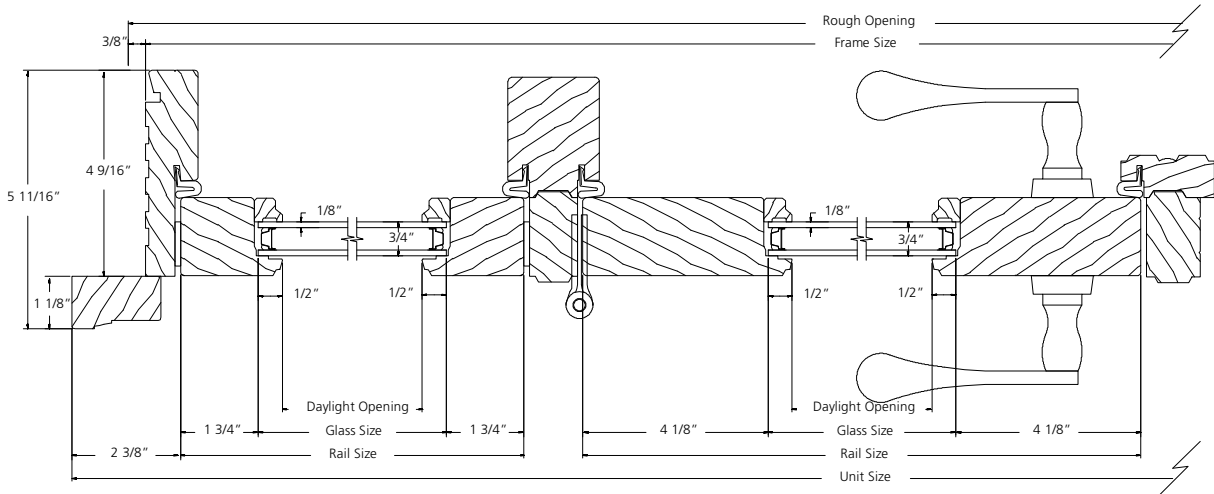

HORIZONTAL SECTION

SCALE: 3" = 1'

2-PANEL FRENCH UNIT

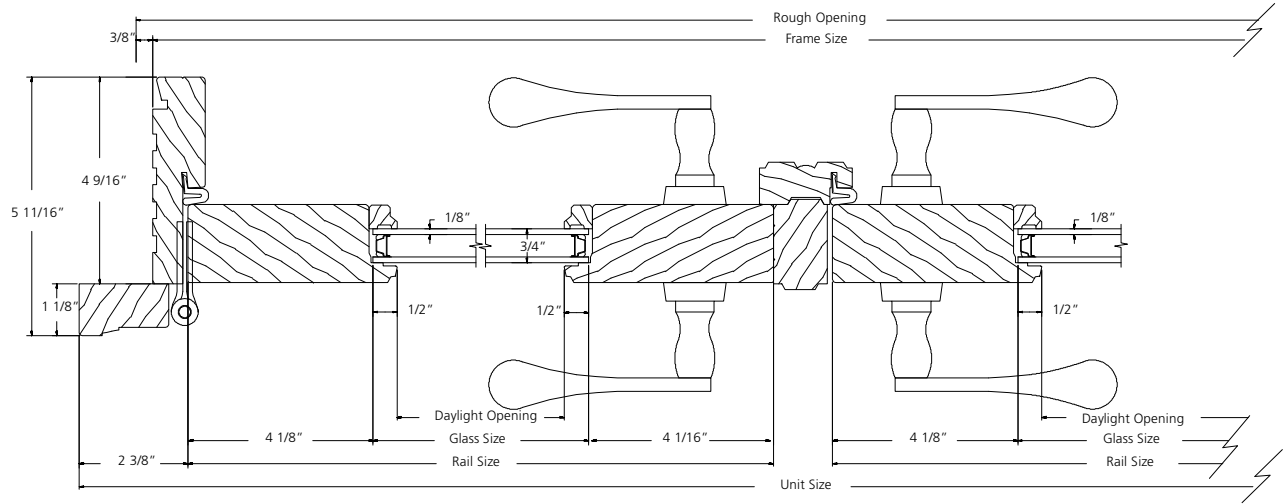

HORIZONTAL SECTION

SCALE: 3" = 1'

STATIONARY UNIT - SIDELITE

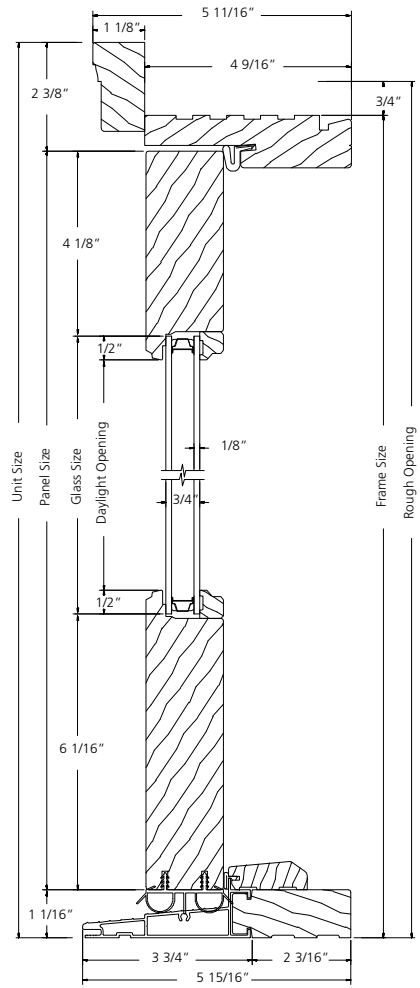

VERTICAL SECTION

SCALE: 3" = 1'

STATIONARY UNIT - SIDELITE

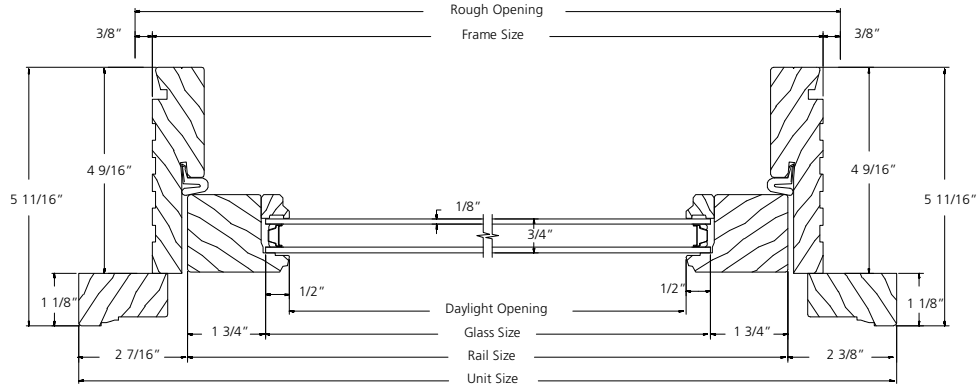

HORIZONTAL SECTION

SCALE: 3" = 1'

**SINGLE SASH TRANSOM
WITH 4-9/16" JAMB**

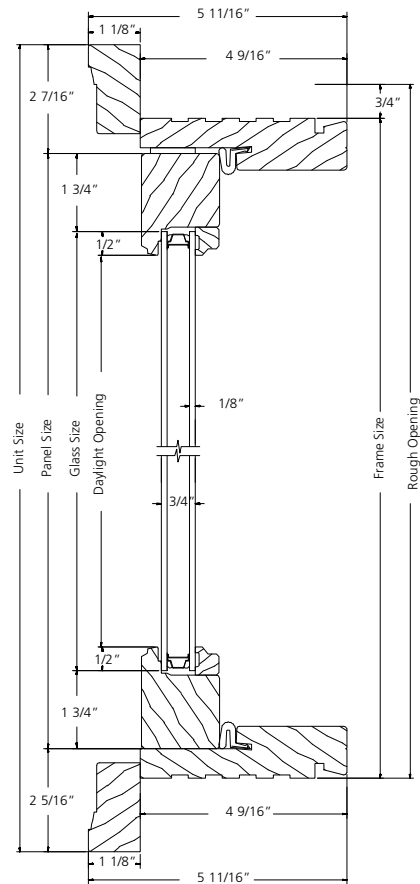

VERTICAL SECTION

SCALE: 3" = 1'

**SINGLE SASH TRANSOM
WITH 6-916" JAMB**

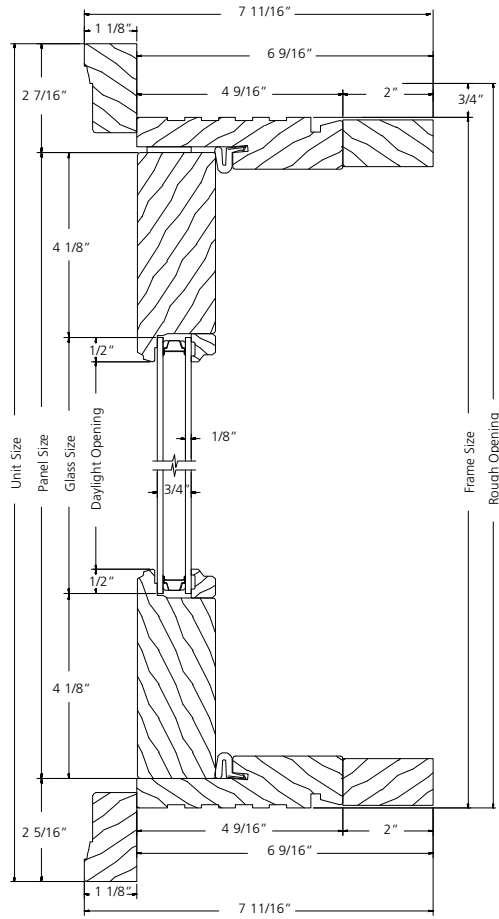

VERTICAL SECTION

SCALE: 3" = 1'

SINGLE SASH TRANSOM

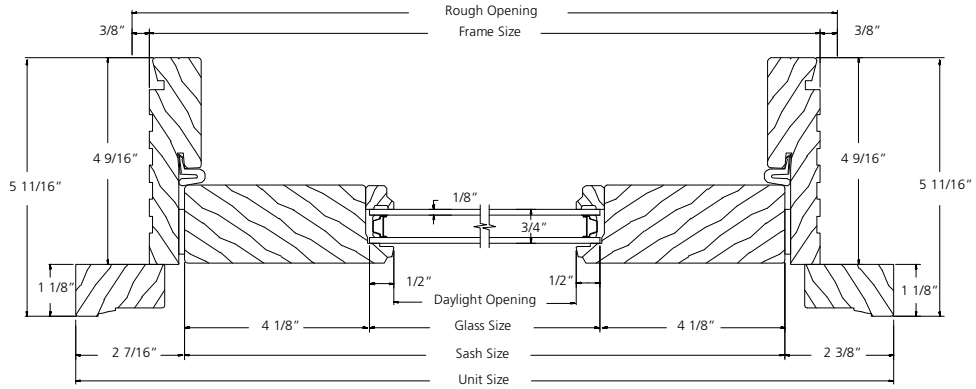

HORIZONTAL SECTION

SCALE: 3" = 1'

MULTI-SASH TRANSOM

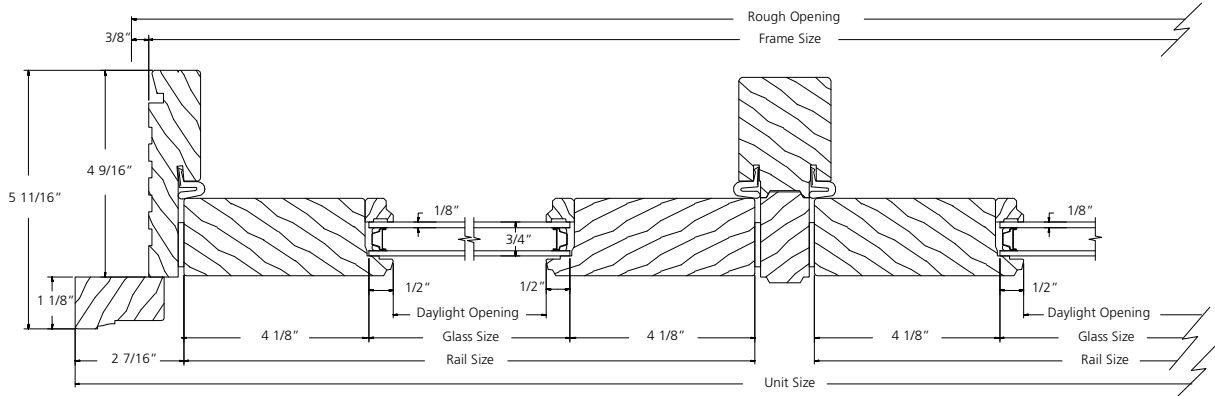

HORIZONTAL SECTION

SCALE: 3" = 1'