

Product Detail Sheets
Table of Contents

Construction Details..... 3

6' - 8" Standard Doors



1-Panel

1' - 0" thru 1' - 10"

.....pg. 4



1-Panel

2' - 0" thru 3' - 0"

.....pg. 5

6' - 8" Bi-Fold Doors



1-Panel Bi-Fold

1' - 0" thru 1' - 6"

.....pg. 6

7' - 0" Standard Doors



1-Panel

1' - 0" thru 1' - 10"

.....pg. 7

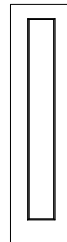

1-Panel

2' - 0" thru 3' - 0"

.....pg. 8

Product Detail Sheets
Table of Contents

7' - 0" Bi-Fold Doors



1-Panel Bi-Fold
1' - 0" thru 1' - 6"
.....pg. 9

8' - 0" Standard Doors



1-Panel
1' - 4" thru 1' - 10"
.....pg. 10

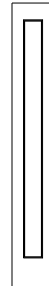

1-Panel
2' - 0" thru 3' - 0"
.....pg. 11

8' - 0" Bi-Fold Doors



1-Panel Bi-Fold
1' - 4" thru 1' - 6"
.....pg. 12

© 2011 JELD-WEN, inc. ALL RIGHTS RESERVED.
NO DUPLICATION OR DISTRIBUTION PERMITTED.
JELD-WEN, inc. CONFIDENTIAL AND PROPRIETARY.

**SOLID PARTICLEBOARD CORE -
COMBINATION WOOD / MDF OR
ALL-WOOD FRAME**

1 3/8" DOOR
1 3/4" DOOR

20-MINUTE FIRE RATING AVAILABLE
OR 1 3/4" UP TO 3'-0" x 8'0"

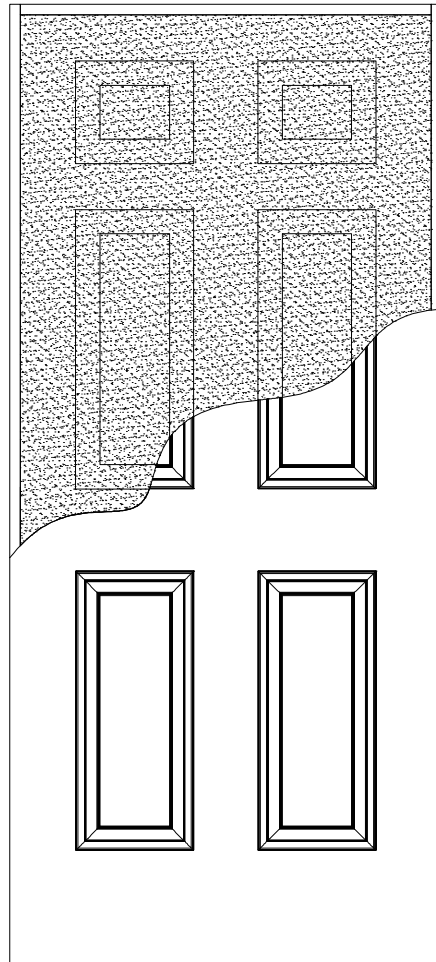

**WIDE STILE WITH SOLID
PARTICLEBOARD CORE -
WOOD FRAME**

1 3/4" DOOR

20-MINUTE FIRE RATING

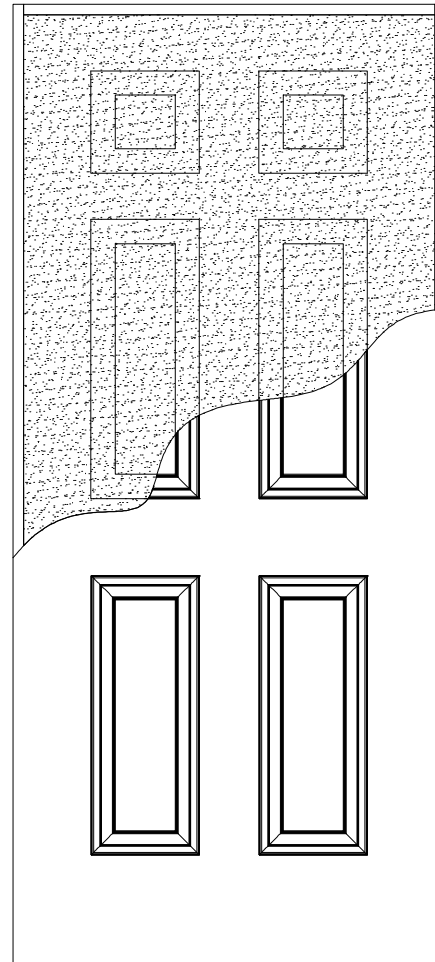

**SOLID MINERAL CORE -
ALL-WOOD FRAME**

1 3/4" DOOR

45- OR 60- MINUTE FIRE RATINGS UP TO 3'-0" x 8'-0",
MANUFACTURED TO THE CURRENT
GEORGIA-PACIFIC OR MARSHFIELD DOOR SYSTEMS
SPECIFICATIONS

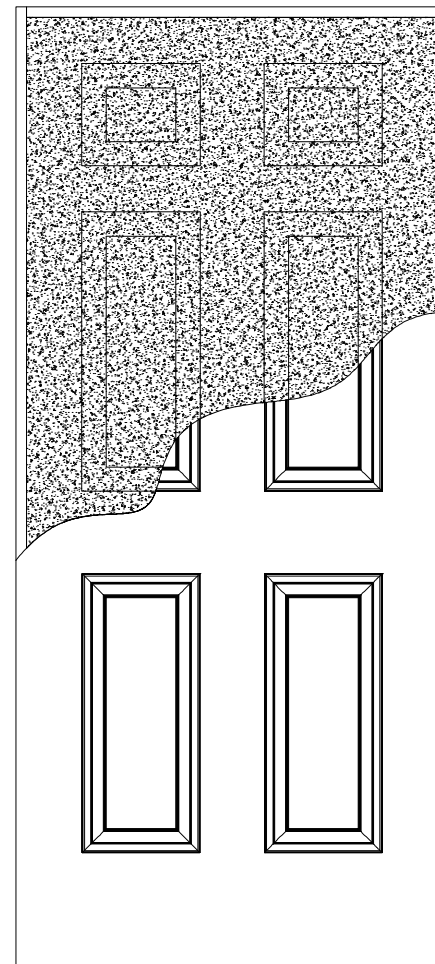

**HOLLOW CORE -
MDF FRAME**

1 3/8" DOOR

BLOCKING BEHIND PANELS FOR SUPPORT*

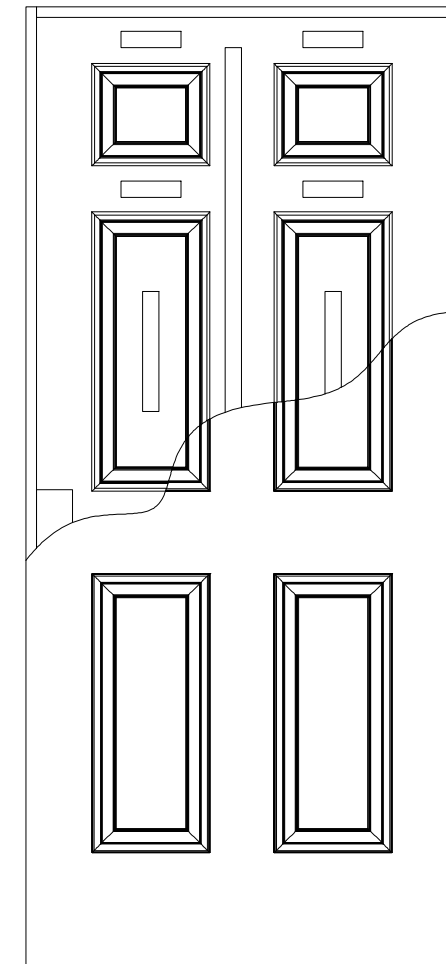

* HOLLOW CORE CONSTRUCTION MAY VARY BY REGION.

CREATION DATE: 10/31/2011		3737 Lakeport Blvd. Klamath Falls, OR 97601 Phone: (800) 441-3884 www.jeld-wen.com
REV. DATE:		
TITLE: MOLDED DOOR CONSTRUCTION DETAILS		
DESCRIPTION: CORE OPTIONS		

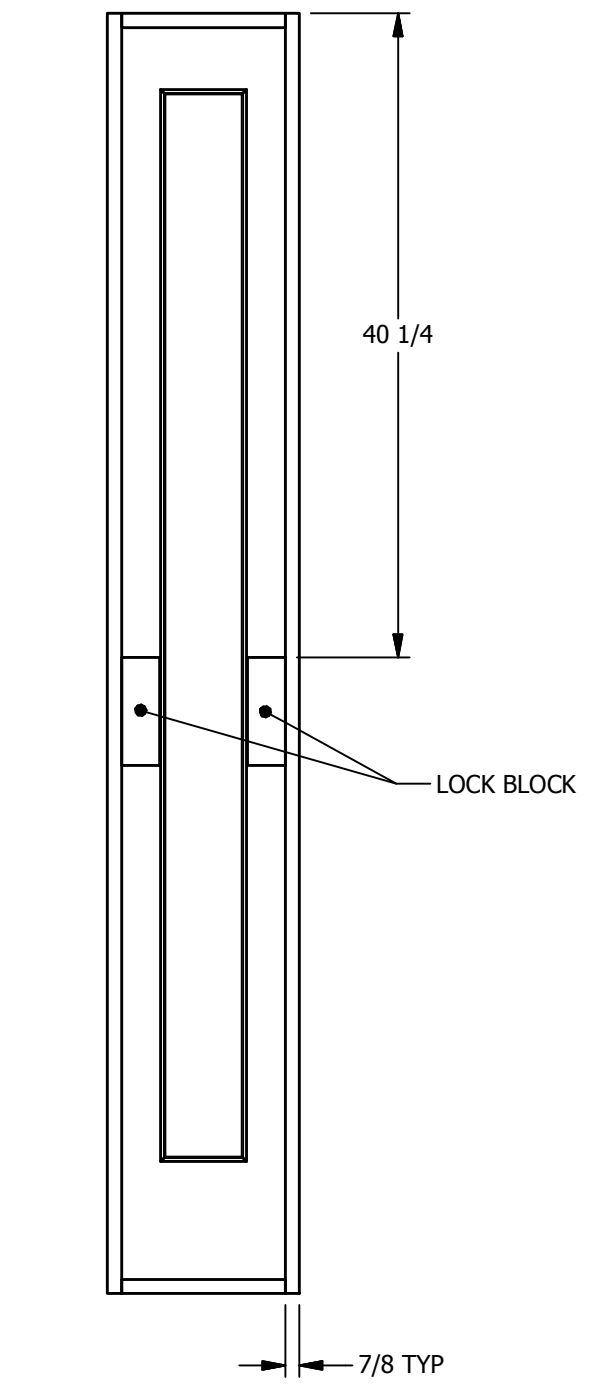
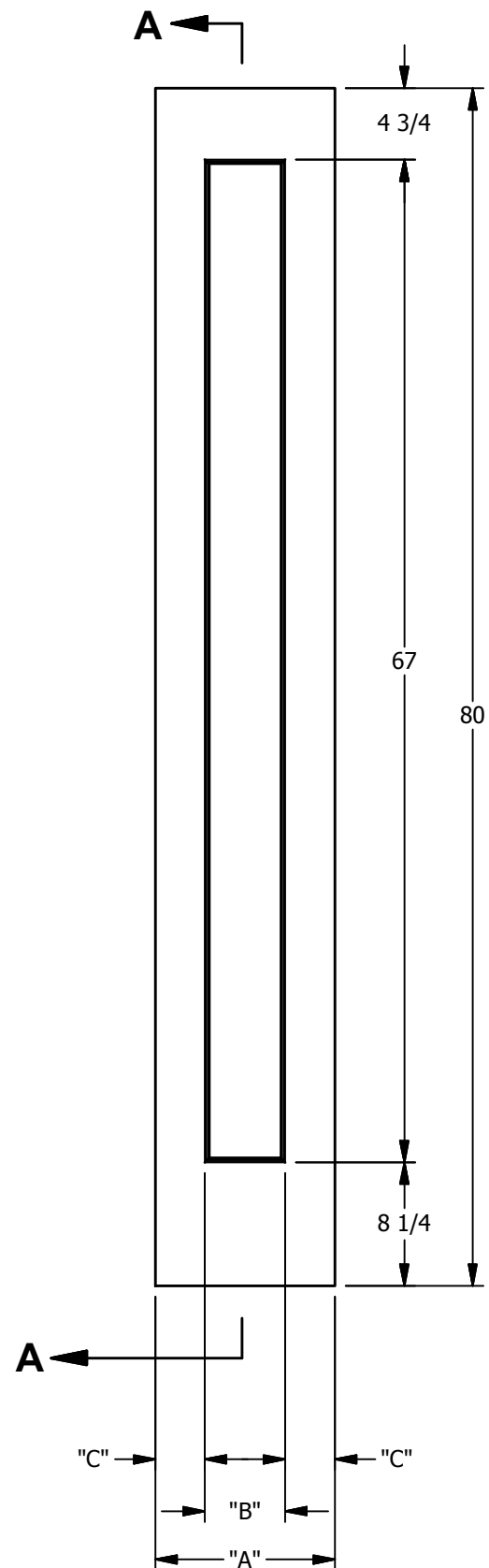

LOCK BLOCK LOCATION
 DOOR SKIN REMOVED

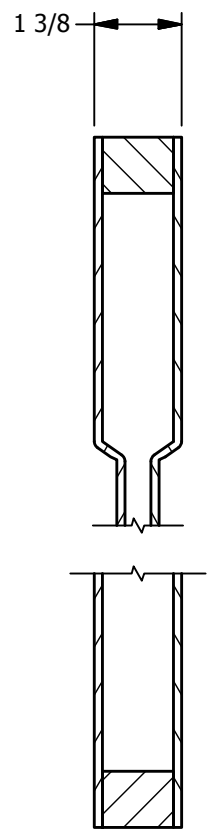

SECTION A-A

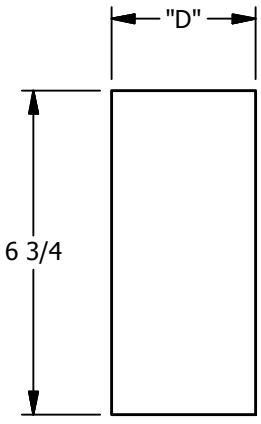

LOCK BLOCK DETAIL

DIMENSION TABLE				
DOOR SIZE	"A"	"B"	"C"	"D"
1'-0" x 6'-8"	12"	5 3/8"	3 5/16"	2 3/8"
1'-2" x 6'-8"	14"	5 3/8"	4 5/16"	3"
1'-3" x 6'-8"	15"	5 3/8"	4 13/16"	3"
1'-4" x 6'-8"	16"	7 13/16"	4 3/32"	3"
1'-6" x 6'-8"	18"	7 13/16"	5 3/32"	3"
1'-8" x 6'-8"	20"	11 1/2"	4 1/4"	3"
1'-10" x 6'-8"	22"	11 1/2"	5 1/4"	3"

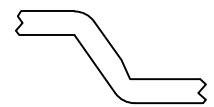

PANEL PROFILE : CRAFTSMAN STICKING

CREATION DATE: 8/7/2012		3737 Lakeport Blvd. Klamath Falls, OR 97601 Phone: (800) 441-3884 www.jeld-wen.com
REV. DATE:		
TITLE: MOLDED INTERIOR DOOR		
DESCRIPTION: MADISON SMOOTH 6'-8" 1'-0", 1'-2", 1'-3", 1'-4", 1'-6", 1'-8", 1'-10"		

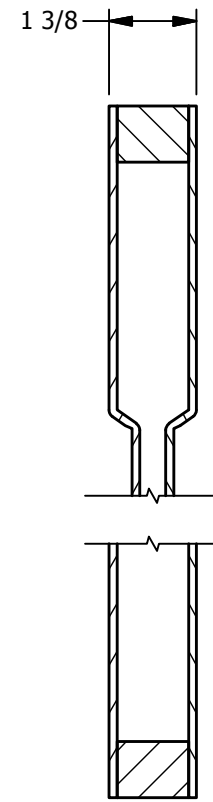
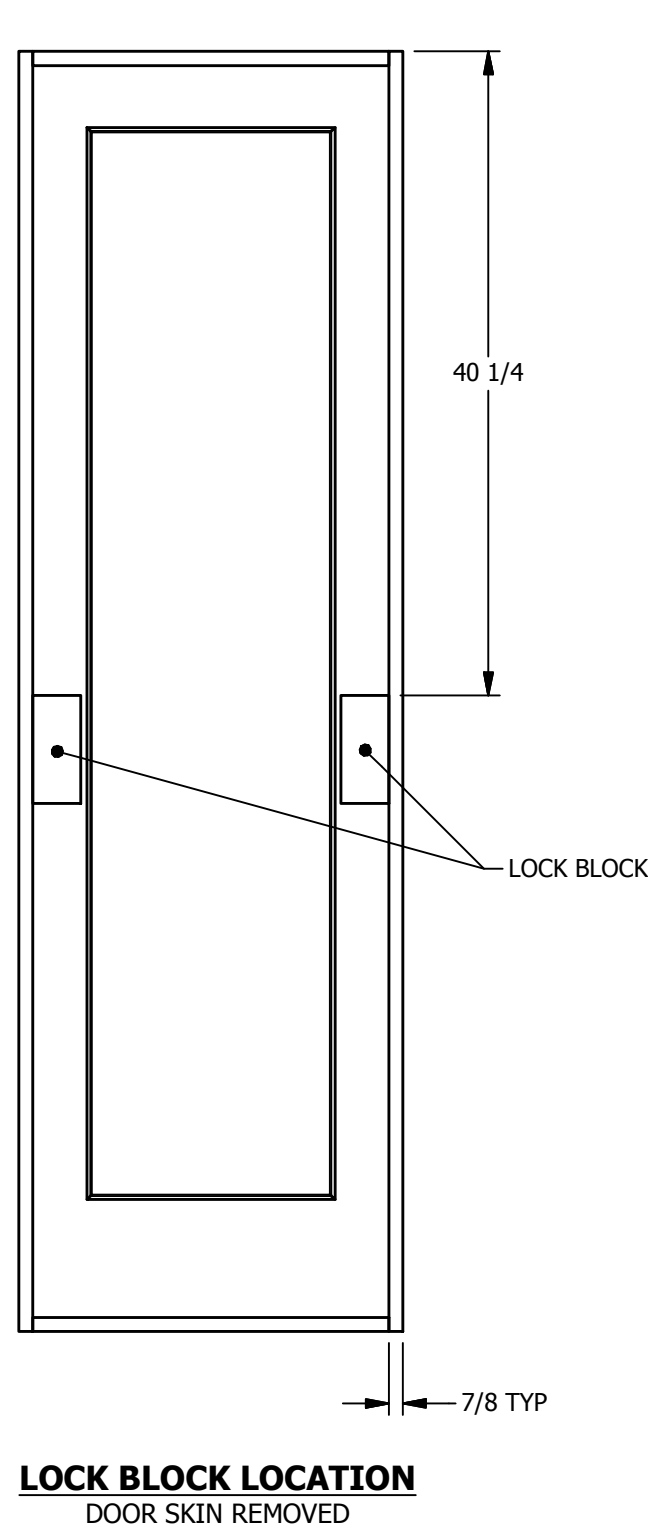
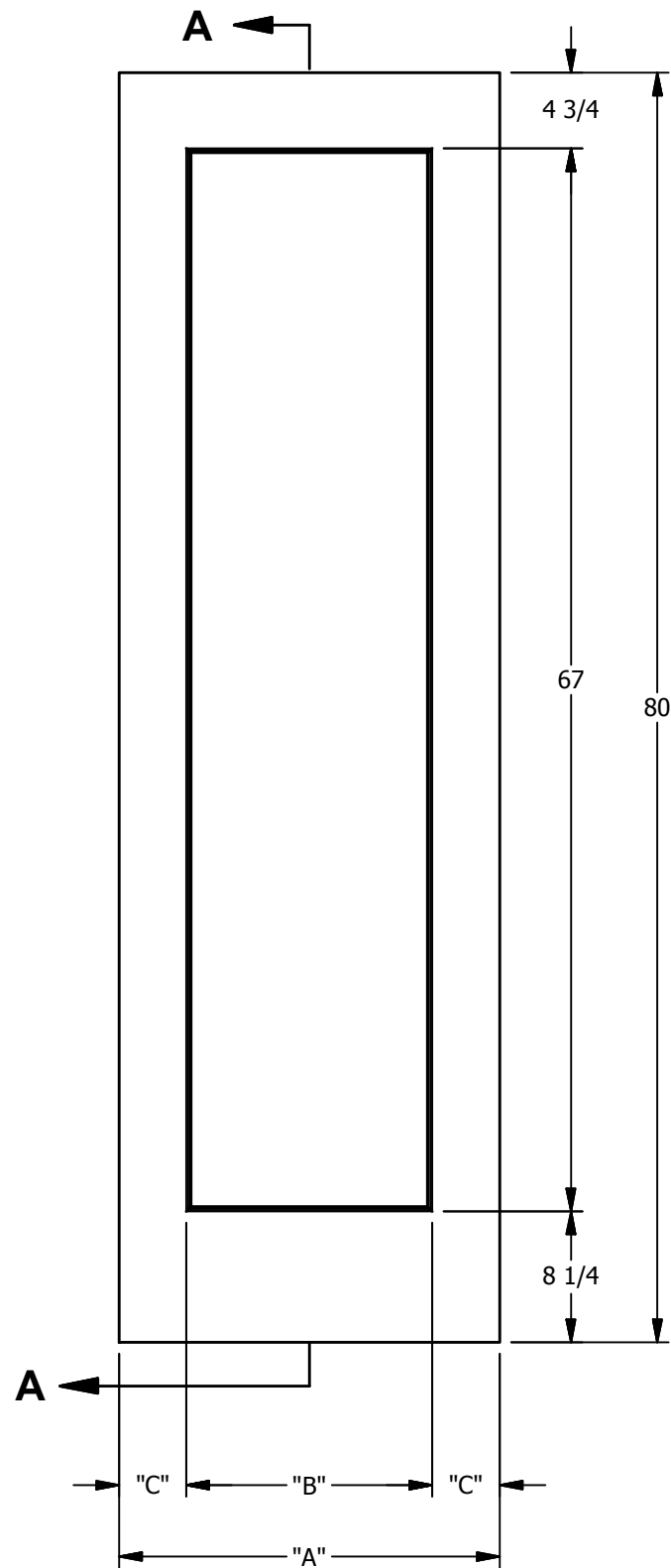

SECTION A-A

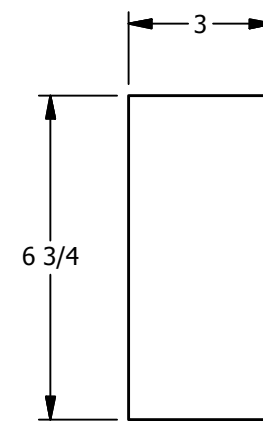

**LOCK BLOCK
DETAIL**

DIMENSION TABLE			
DOOR SIZE	"A"	"B"	"C"
2'-0" x 6'-8"	24"	15 1/2"	4 1/4"
2'-2" x 6'-8"	26"	15 1/2"	5 1/4"
2'-4" x 6'-8"	28"	18 1/2"	4 3/4"
2'-6" x 6'-8"	30"	20 1/2"	4 3/4"
2'-8" x 6'-8"	32"	22 1/2"	4 3/4"
2'-10" x 6'-8"	34"	22 1/2"	5 3/4"
3'-0" x 6'-8"	36"	26 1/2"	4 3/4"



PANEL PROFILE : CRAFTSMAN STICKING

CREATION DATE: 8/7/2012		3737 Lakeport Blvd. Klamath Falls, OR 97601 Phone: (800) 441-3884 www.jeld-wen.com
REV. DATE:		
TITLE:	MOLDED INTERIOR DOOR	
DESCRIPTION:	MADISON SMOOTH 6'-8" 2'-0", 2'-2", 2'-4", 2'-6", 2'-8", 2'-10", 3'-0"	

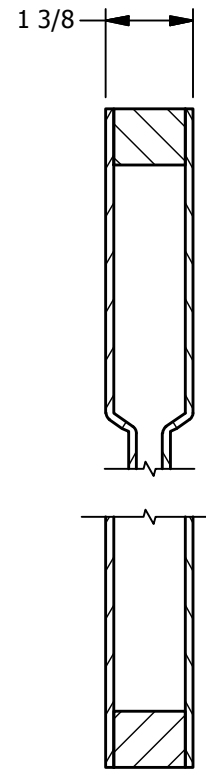
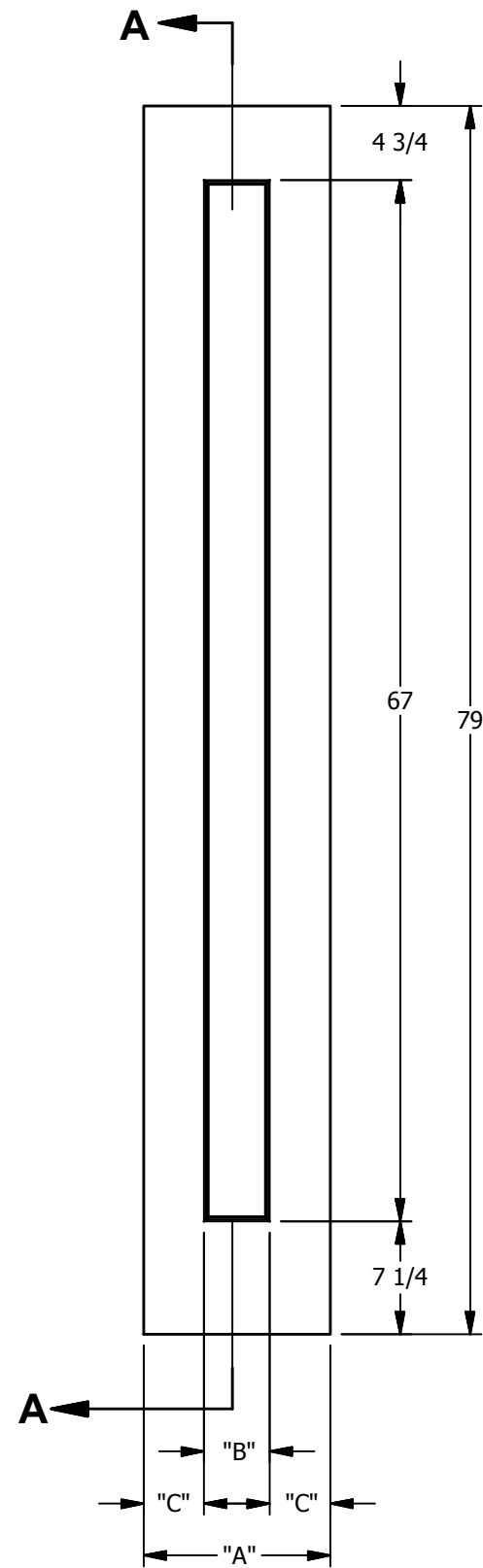

SECTION A-A

DIMENSION TABLE			
DOOR SIZE	"A"	"B"	"C"
1'-0" x 6'-8"	12"	4 1/4"	3 7/8"
1'-2" x 6'-8"	14"	5 3/8"	4 5/16"
1'-3" x 6'-8"	15"	5 3/8"	4 13/16"
1'-4" x 6'-8"	16"	7 13/16"	4 3/32"
1'-6" x 6'-8"	18"	7 13/16"	5 3/32"

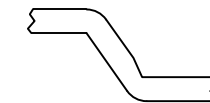

PANEL PROFILE : CRAFTSMAN STICKING

CREATION DATE: 8/7/2012		3737 Lakeport Blvd. Klamath Falls, OR 97601 Phone: (800) 441-3884 www.jeld-wen.com
REV. DATE:		
TITLE: MOLDED INTERIOR DOOR		
DESCRIPTION: MADISON BI-FOLD SMOOTH 6'-8" 1'-0", 1'-2", 1'-3", 1'-4", 1'-6"		

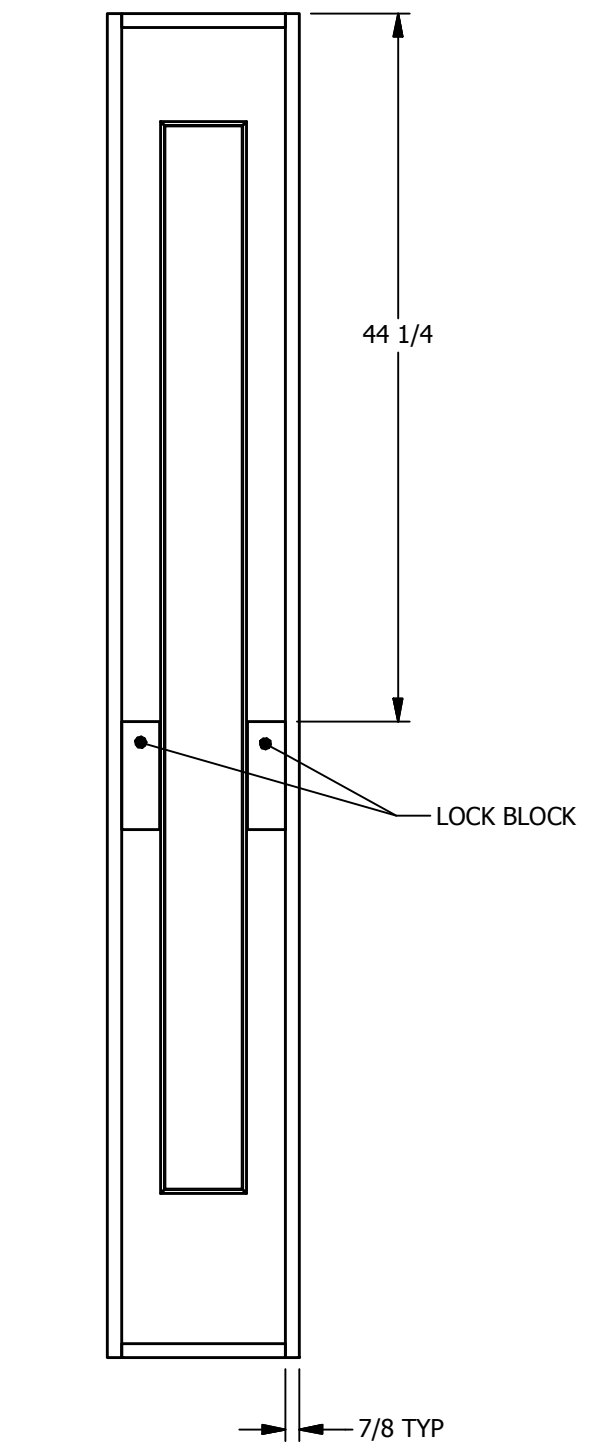
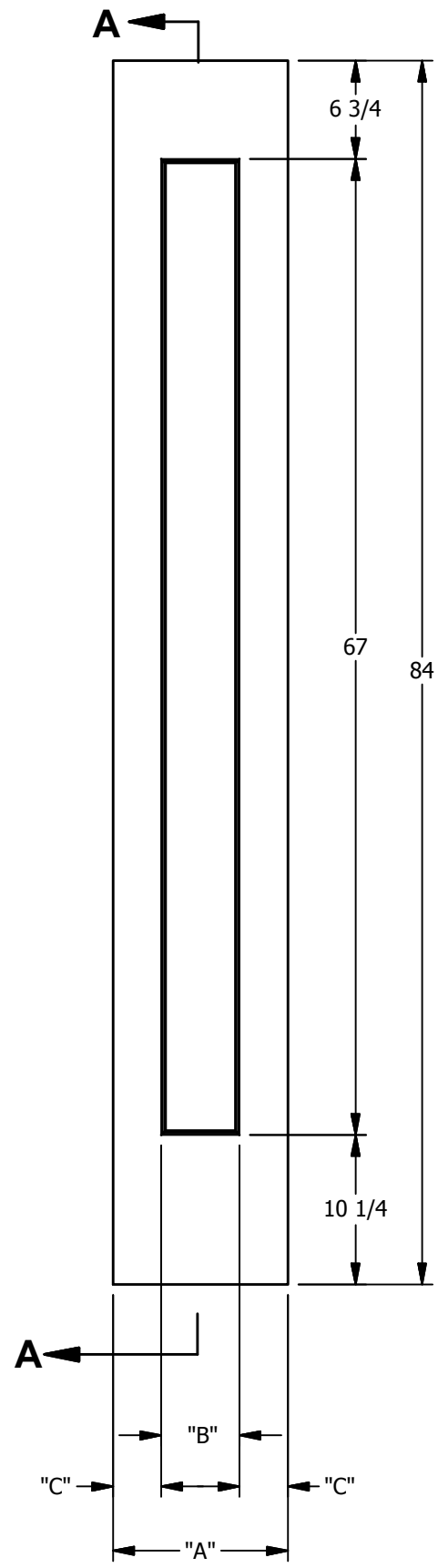

LOCK BLOCK LOCATION
 DOOR SKIN REMOVED

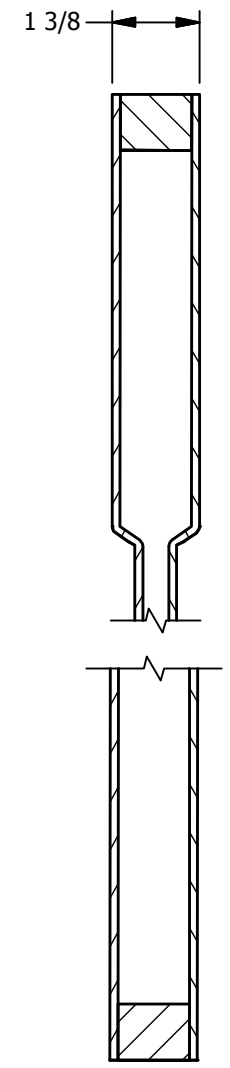

SECTION A-A

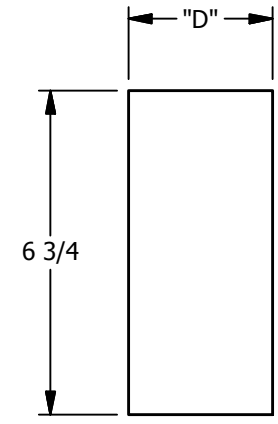

LOCK BLOCK DETAIL

DIMENSION TABLE				
DOOR SIZE	"A"	"B"	"C"	"D"
1'-0" x 7'-0"	12"	5 3/8"	3 5/16"	2 3/8"
1'-2" x 7'-0"	14"	5 3/8"	4 5/16"	3"
1'-3" x 7'-0"	15"	5 3/8"	4 13/16"	3"
1'-4" x 7'-0"	16"	7 13/16"	4 3/32"	3"
1'-6" x 7'-0"	18"	7 13/16"	5 3/32"	3"
1'-8" x 7'-0"	20"	11 1/2"	4 1/4"	3"
1'-10" x 7'-0"	22"	11 1/2"	5 1/4"	3"



PANEL PROFILE : CRAFTSMAN STICKING

CREATION DATE: 10/25/2012		3737 Lakeport Blvd. Klamath Falls, OR 97601 Phone: (800) 441-3884 www.jeld-wen.com
REV. DATE:		
TITLE: MOLDED INTERIOR DOOR		
DESCRIPTION: MADISON SMOOTH 7'-0" 1'-0", 1'-2", 1'-3", 1'-4", 1'-6", 1'-8", 1'-10"		

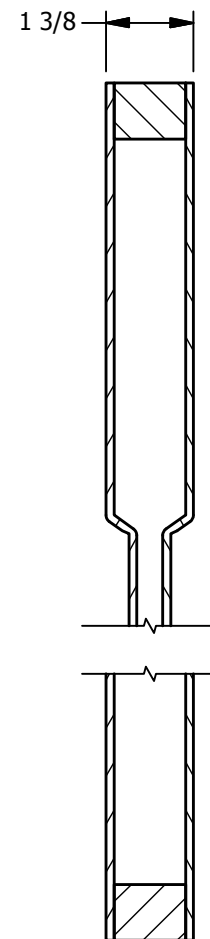
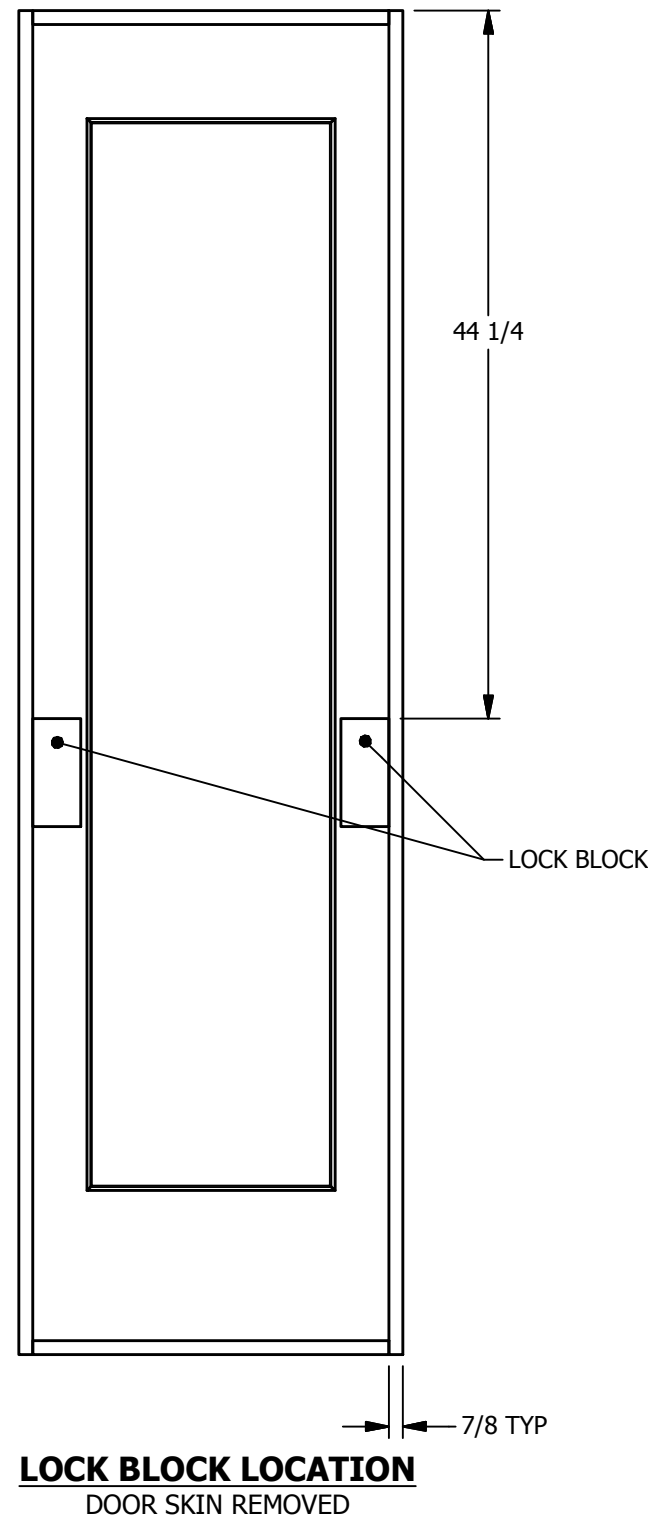
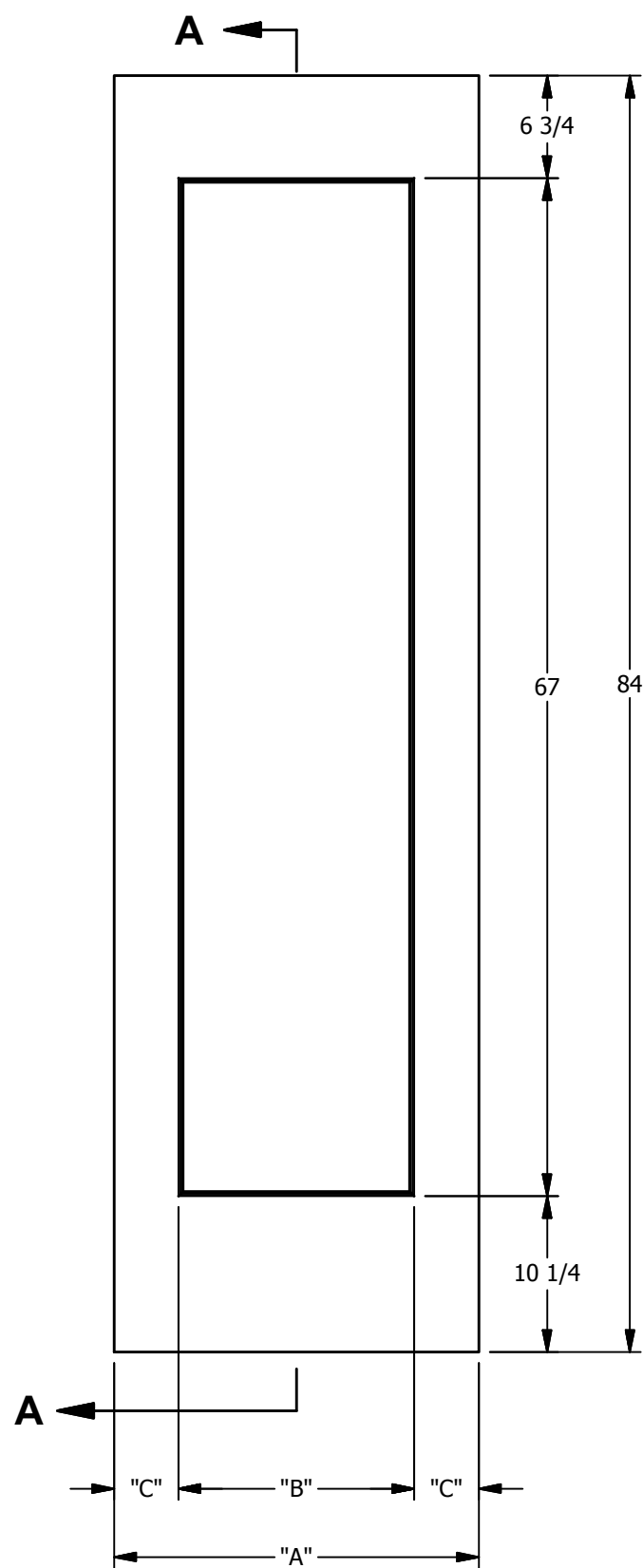

SECTION A-A

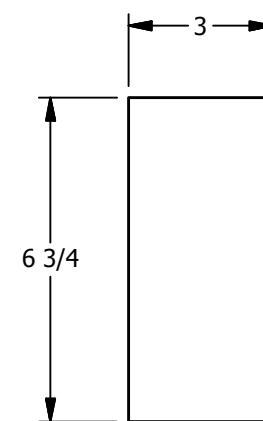

LOCK BLOCK DETAIL

DIMENSION TABLE			
DOOR SIZE	"A"	"B"	"C"
2'-0" x 7'-0"	24"	15 1/2"	4 1/4"
2'-2" x 7'-0"	26"	15 1/2"	5 1/4"
2'-4" x 7'-0"	28"	18 1/2"	4 3/4"
2'-6" x 7'-0"	30"	20 1/2"	4 3/4"
2'-8" x 7'-0"	32"	22 1/2"	4 3/4"
2'-10" x 7'-0"	34"	22 1/2"	5 3/4"
3'-0" x 7'-0"	36"	26 1/2"	4 3/4"



PANEL PROFILE : CRAFTSMAN STICKING

CREATION DATE: 10/25/2012		3737 Lakeport Blvd. Klamath Falls, OR 97601 Phone: (800) 441-3884 www.jeld-wen.com
REV. DATE:		
TITLE: MOLDED INTERIOR DOOR		
DESCRIPTION: MADISON SMOOTH 7'-0" 2'-0", 2'-2", 2'-4", 2'-6", 2'-8", 2'-10", 3'-0"		

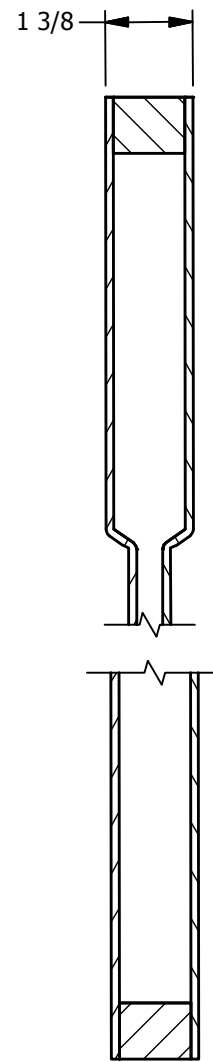
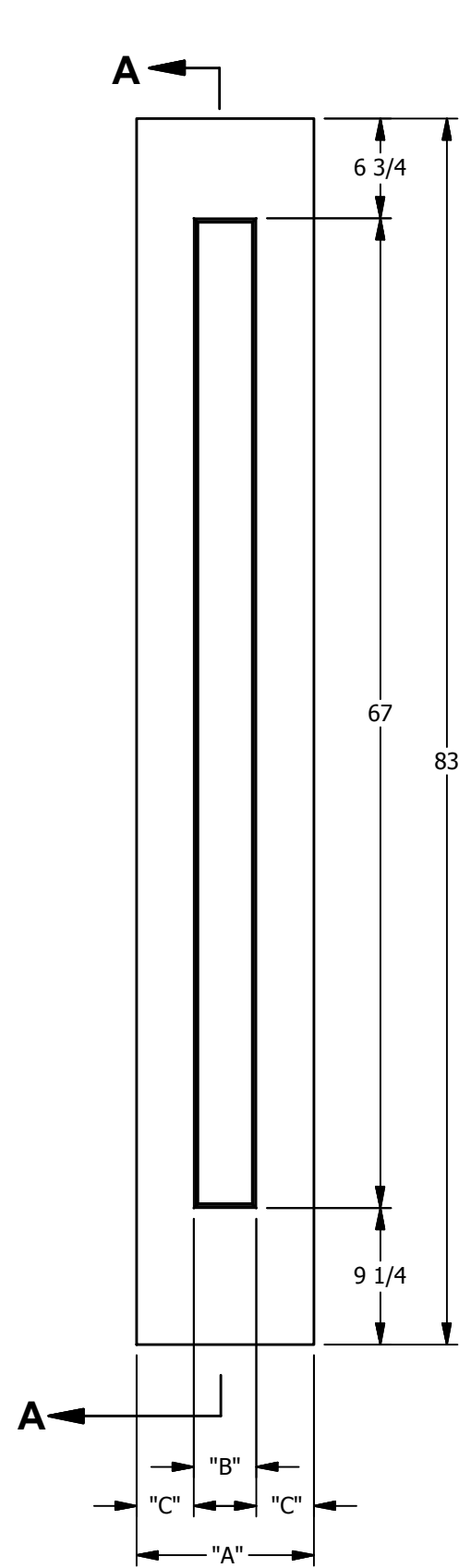

SECTION A-A

DIMENSION TABLE			
DOOR SIZE	"A"	"B"	"C"
1'-0" x 7'-0"	12"	4 1/4"	3 7/8"
1'-2" x 7'-0"	14"	5 3/8"	4 5/16"
1'-3" x 7'-0"	15"	5 3/8"	4 13/16"
1'-4" x 7'-0"	16"	7 13/16"	4 3/32"
1'-6" x 7'-0"	18"	7 13/16"	5 3/32"



PANEL PROFILE : CRAFTSMAN STICKING

CREATION DATE: 10/25/2012		3737 Lakeport Blvd. Klamath Falls, OR 97601 Phone: (800) 441-3884 www.jeld-wen.com
REV. DATE:		
TITLE: MOLDED INTERIOR DOOR		
DESCRIPTION: MADISON BI-FOLD SMOOTH 7'-0" 1'-0", 1'-2", 1'-3", 1'-4", 1'-6"		

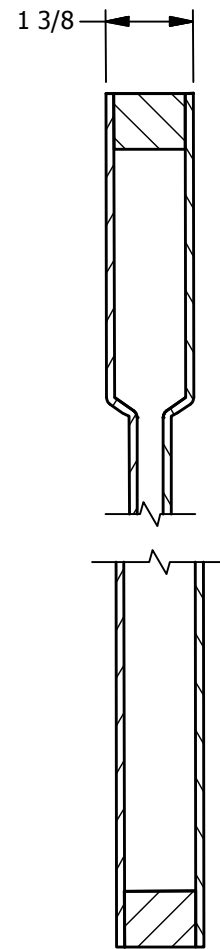
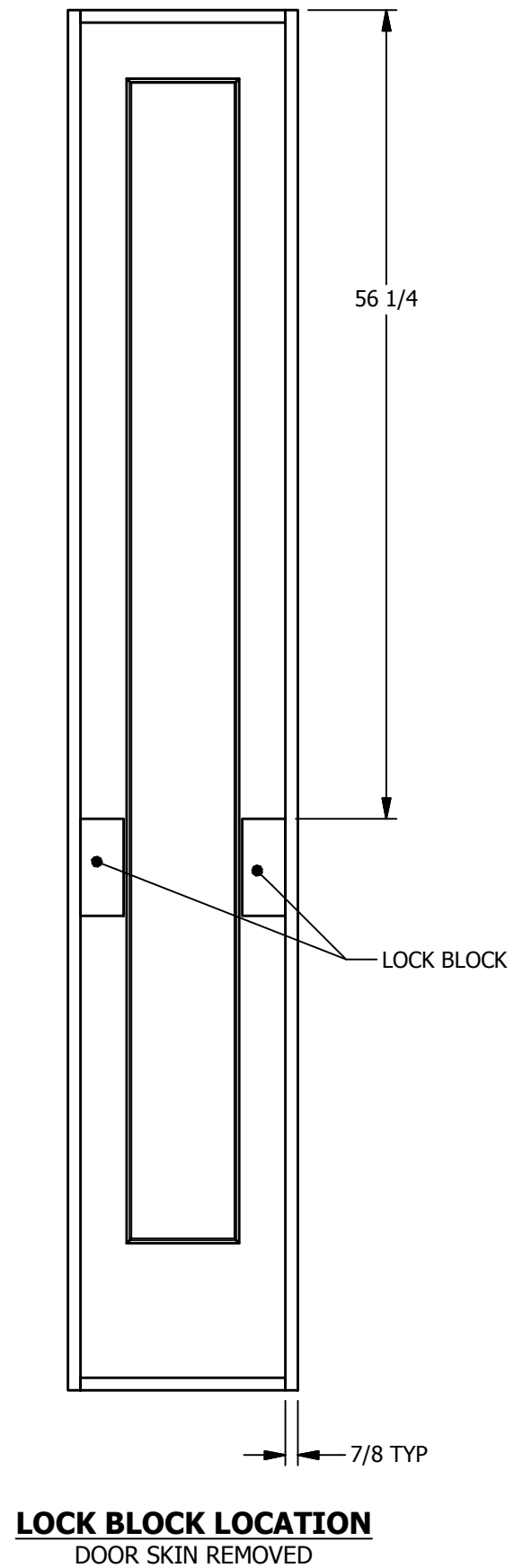
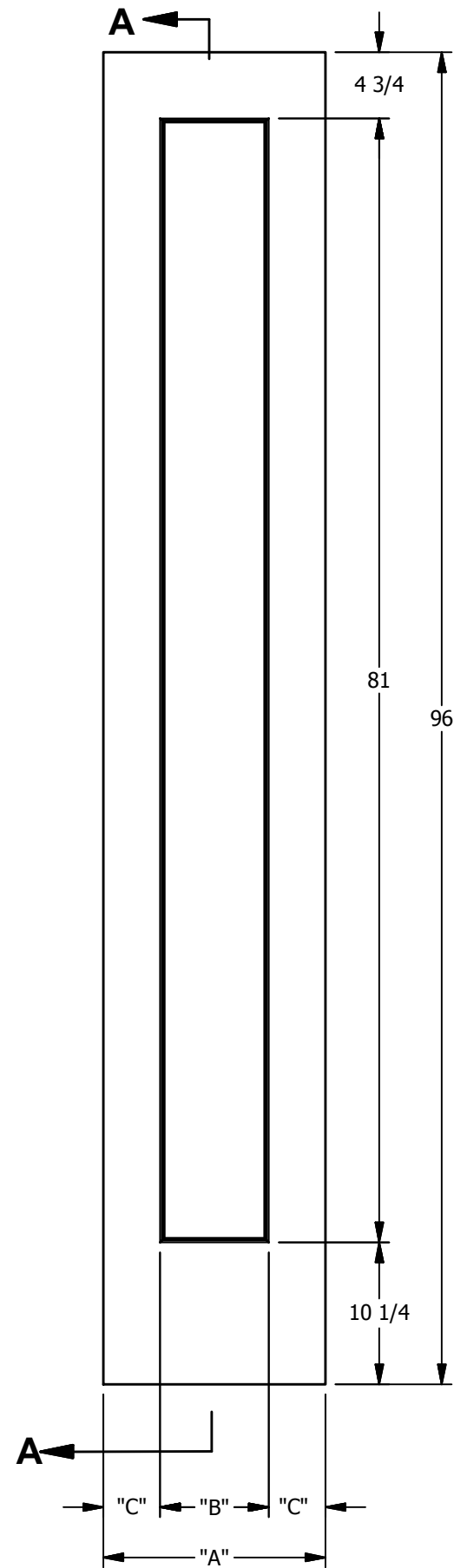

DIMENSION TABLE			
DOOR SIZE	"A"	"B"	"C"
1'-4" x 8'-0"	16"	7 13/16"	4 3/32"
1'-6" x 8'-0"	18"	7 13/16"	5 3/32"
1'-8" x 8'-0"	20"	11 1/2"	4 1/4"
1'-10" x 8'-0"	22"	11 1/2"	5 1/4"

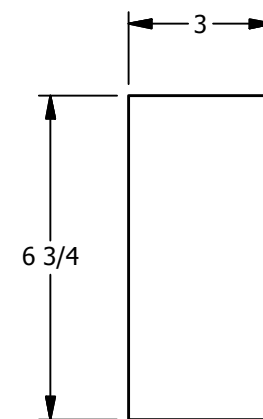

PANEL PROFILE : CRAFTSMAN STICKING

CREATION DATE: 10/25/2012		3737 Lakeport Blvd. Klamath Falls, OR 97601 Phone: (800) 441-3884 www.jeld-wen.com
REV. DATE:		
TITLE: MOLDED INTERIOR DOOR		
DESCRIPTION: MADISON SMOOTH 8'-0" 1'-4", 1'-6", 1'-8", 1'-10"		

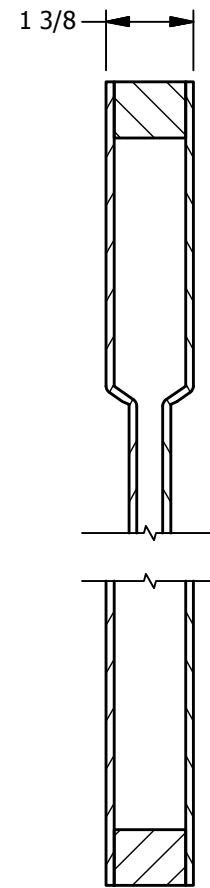
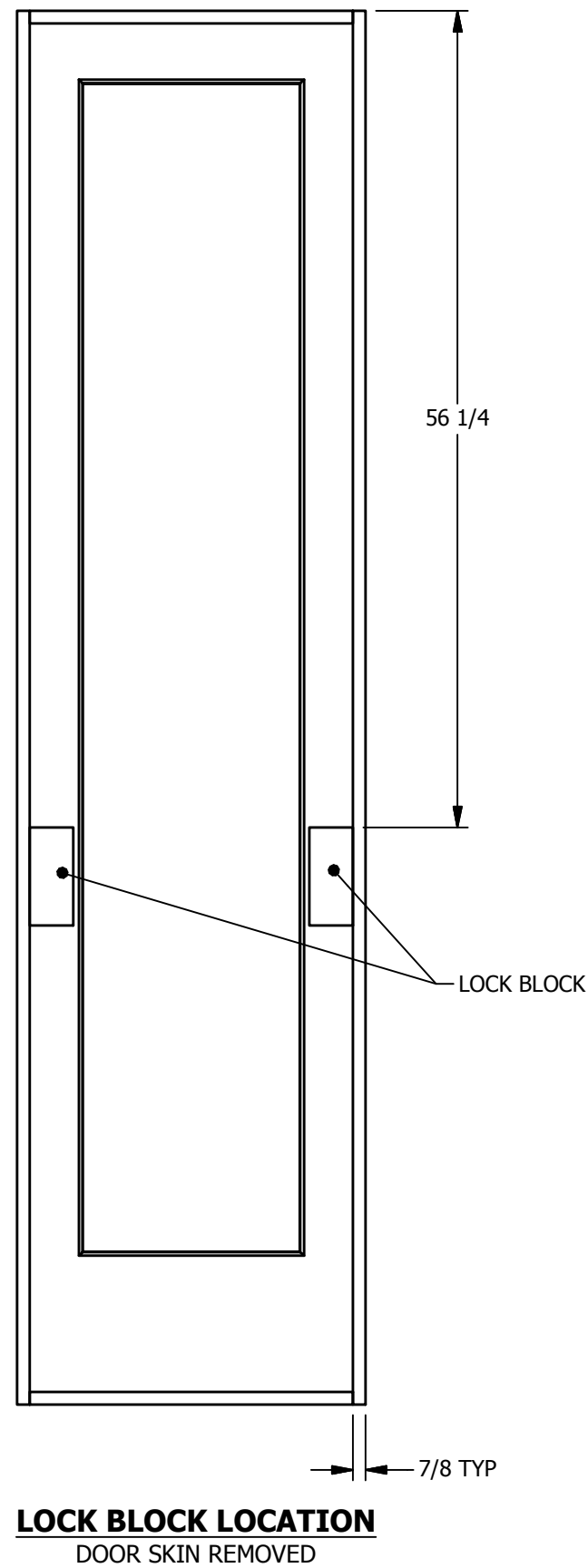
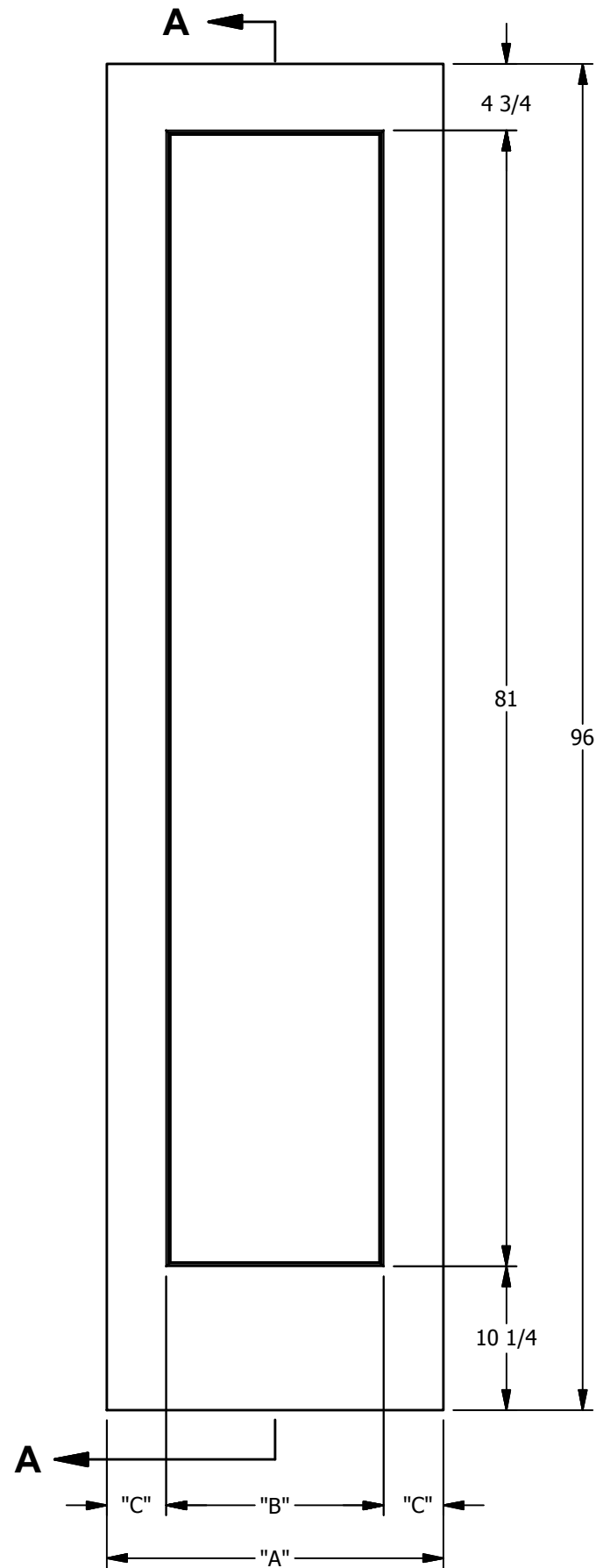

SECTION A-A

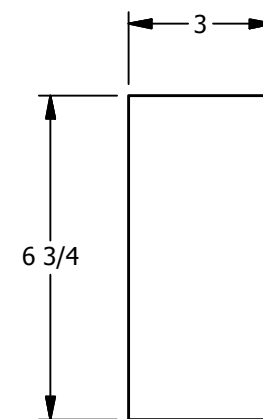

**LOCK BLOCK
DETAIL**

DIMENSION TABLE			
DOOR SIZE	"A"	"B"	"C"
2'-0" x 8'-0"	24"	15 1/2"	4 1/4"
2'-2" x 8'-0"	26"	15 1/2"	5 1/4"
2'-4" x 8'-0"	28"	18 1/2"	4 3/4"
2'-6" x 8'-0"	30"	20 1/2"	4 3/4"
2'-8" x 8'-0"	32"	22 1/2"	4 3/4"
2'-10" x 8'-0"	34"	22 1/2"	5 3/4"
3'-0" x 8'-0"	36"	26 1/2"	4 3/4"



PANEL PROFILE : CRAFTSMAN STICKING

CREATION DATE: 10/25/2012		3737 Lakeport Blvd. Klamath Falls, OR 97601 Phone: (800) 441-3884 www.jeld-wen.com
REV. DATE: 5/1/2013		
TITLE: MOLDED INTERIOR DOOR		
DESCRIPTION: MADISON SMOOTH 8'-0" 2'-0", 2'-2", 2'-4", 2'-6", 2'-8", 2'-10", 3'-0"		

© 2012 JELD-WEN, inc. ALL RIGHTS RESERVED.
 NO DUPLICATION OR DISTRIBUTION PERMITTED.
 JELD-WEN, inc. CONFIDENTIAL AND PROPRIETARY.

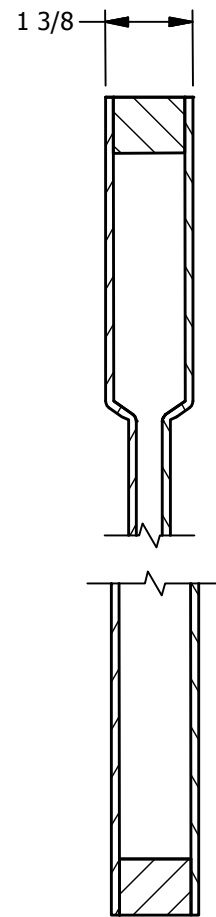
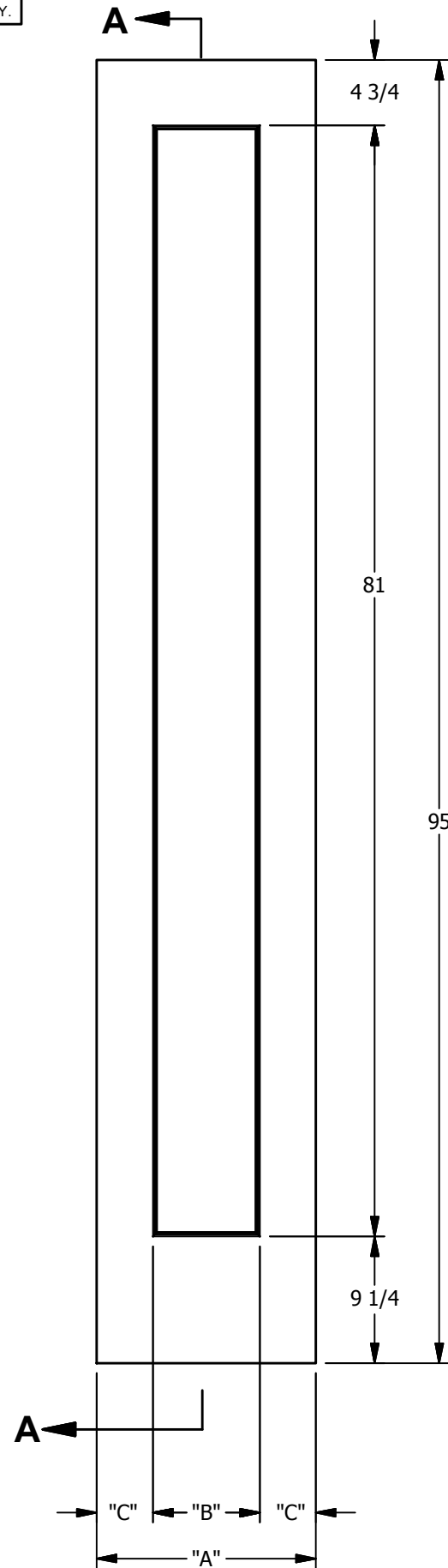

SECTION A-A

DIMENSION TABLE			
DOOR SIZE	"A"	"B"	"C"
1'-4" x 8'-0"	16"	7 13/16"	4 3/32"
1'-6" x 8'-0"	18"	7 13/16"	5 3/32"



PANEL PROFILE : CRAFTSMAN STICKING

CREATION DATE: 10/25/2012		3737 Lakeport Blvd. Klamath Falls, OR 97601 Phone: (800) 441-3884 www.jeld-wen.com
REV. DATE:		
TITLE: MOLDED INTERIOR DOOR		
DESCRIPTION: MADISON BI-FOLD SMOOTH 8'-0" 1'-4", 1'-6"		