

TABLE OF CONTENTS

General Information . . . . .	6-2
Elevation Notes . . . . .	6-3
Elevations/Sizes:	
Operating Units . . . . .	6-4
Stationary Units . . . . .	6-8
2-Wide 1-High. . . . .	6-12
1-Wide 2-High. . . . .	6-14
2-Wide 2-High. . . . .	6-16
30" Width Combinations.. . . . .	6-18
32" Width Combinations.. . . . .	6-22
36" Width Combinations.. . . . .	6-26
42" Width Combinations.. . . . .	6-30
48" Width Combinations.. . . . .	6-34
Glazing Options . . . . .	6-38
Unit Sizing, Rough Opening & Masonry Openings . . . . .	6-42
Trim Options . . . . .	6-43
Sill Options . . . . .	6-44
Jamb & Stucco Trim Options . . . . .	6-45
Mullion Details . . . . .	6-46
Grille & SDL Patterns . . . . .	6-47
Vent Projections . . . . .	6-48
Section Details: 6" Scale. . . . .	6-49

---

GENERAL INFORMATION

---

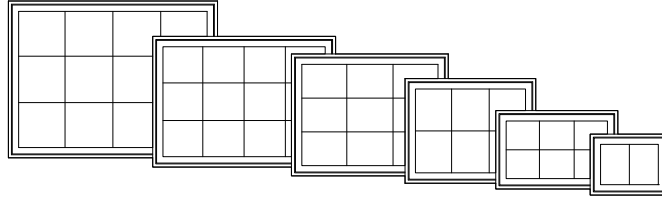
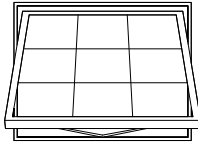

**DIMENSIONAL WINDOWS**

Wood awning windows may be specified as "dimensional", by adjusting the desired rough opening width or height in 1/16" increments from standard.

Wood awning windows are available as operating, or stationary (non - venting). Operating mechanism includes corrosion resistant steel hinges and roto type operators for venting units. Sash locks are concealed unison type with an exposed locking lever and escutcheon plate. There are several interior hardware finish options. Refer to the Specifications for finish options.

**MULTIPLE ASSEMBLIES**

Wood awning windows may be mullied above, below, or beside other wood awning windows, or other wood window products. Factory assembled mulls are limited in height (100"), width (150"), and a total area (75 square feet).

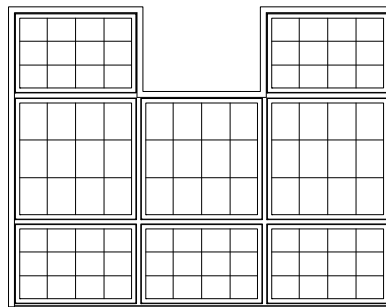
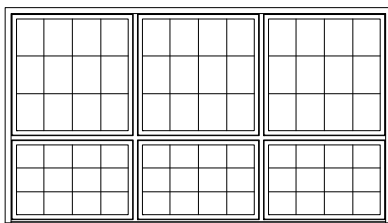
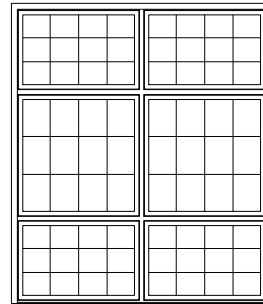
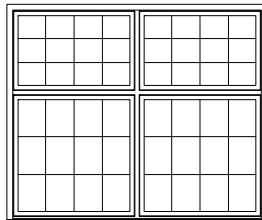
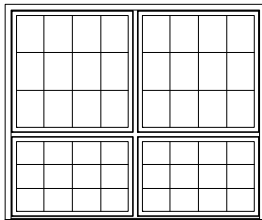

ELEVATION NOTES

ELEVATION DRAWINGS UTILIZE A LIMITED NUMBER OF PROJECTED LINES TO PRODUCE A RUDIMENTARY DRAWING INTENDED TO BE USED IN A SMALL GRAPHICAL SCALE. ELEVATIONS ARE VIEWED PERPENDICULAR FROM THE EXTERIOR OF THE STRUCTURE. IF MORE DIMENSIONS ARE NEEDED, USE THE SECTION DRAWINGS FOR MORE COMPLETE DEPICTIONS.

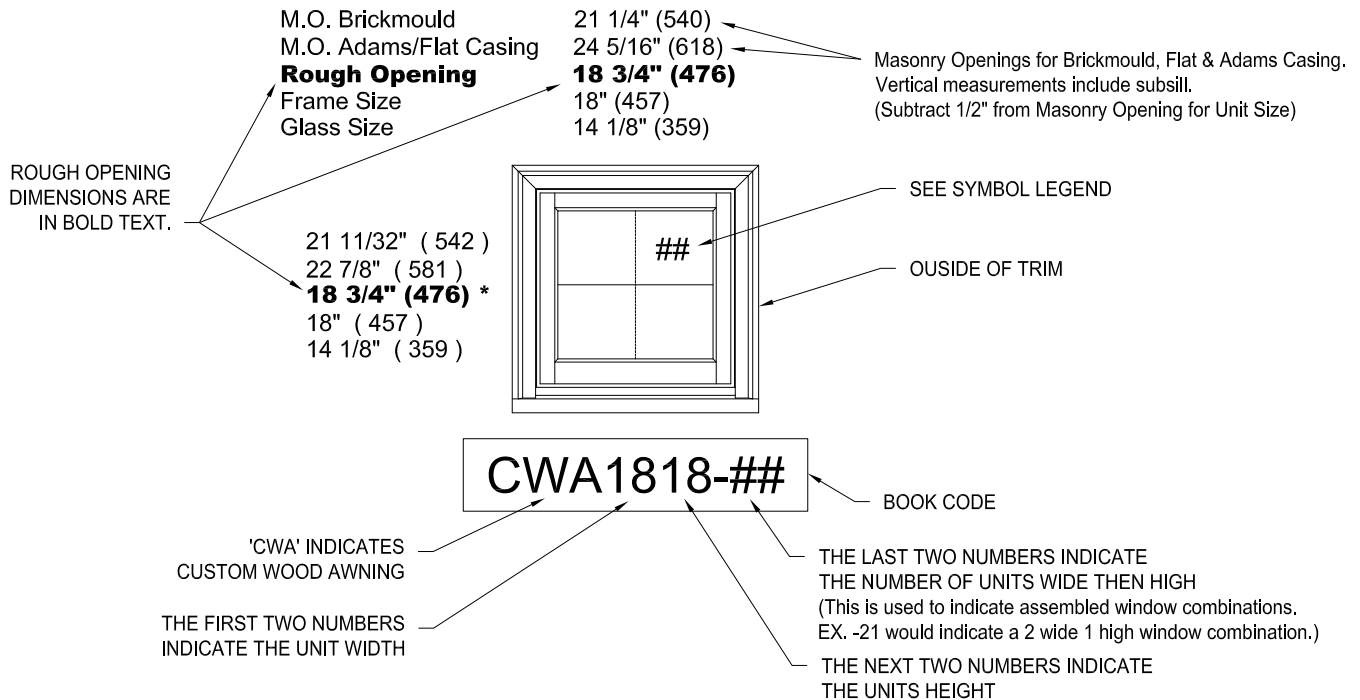

**WOOD AWNING PICTURE COMBINATIONS**

**GENERAL AWNING NOTES**

1. CUSTOM WOOD AWNING (CWA) UNITS ARE AVAILABLE AS OPERATING OR FIXED UNITS.
2. UNIT ELEVATIONS ARE SHOWN WITH BRICKMOULD AND THE OPTIONAL SILL NOSE.
3. DIMENSIONAL VALUES IN PARENTHESES ARE MILLIMETER CONVERSIONS.

\* ROUGH OPENING HEIGHTS ARE WITHOUT SILL NOSE OPTION. ADD 7/8" TO THE STANDARD ROUGH OPENINGS FOR UNITS THAT INCLUDE THE SILL NOSE OPTION.

**ELEVATION SYMBOL LEGEND:**

- (F) THESE UNITS ARE ONLY AVAILABLE AS FIXED (STATIONARY) UNITS.
- ## NUMBER INDICATES PERFORMANCE GRADE (PG) RATING WITH STANDARD GLAZING. OPERATING UNITS UTILIZE A CONCEALED LOCKING SYSTEM FOR DP RATINGS.

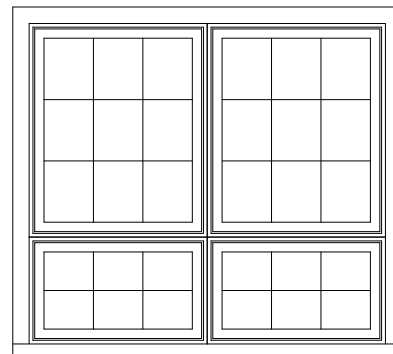

WAP303618

THE THIRD AND FOURTH NUMBERS OF THE BOOK CODE INDICATE THE PICTURE UNIT HEIGHT.

**ELEVATIONS  
OPERATING UNITS**

MO BRICKMOLD  
MO FLAT CASING  
ROUGH OPENING  
FRAME SIZE  
DAYLIGHT OPENING

21 1/4"(540)  
24 5/16"(618)  
18 3/4"(476)  
18"(457)  
13 1/16"(332)

23 1/4"(591)  
26 5/16"(668)  
20 3/4"(527)  
20"(508)  
15 1/16"(383)

27 1/4"(692)  
30 5/16"(770)  
24 3/4"(629)  
24"(610)  
19 1/16"(484)

31 1/4"(794)  
34 5/16"(872)  
28 3/4"(730)  
28"(711)  
23 1/16"(586)

33 1/4"(845)  
36 5/16"(922)  
30 3/4"(781)  
30"(762)  
25 1/16"(637)

35 1/4"(895)  
38 5/16"(973)  
32 3/4"(832)  
32"(813)  
27 1/16"(687)

39 1/4"(997)  
42 5/16"(1075)  
36 3/4"(933)  
36"(914)  
31 1/16"(789)

17 11/32"(441)  
18 7/8"(479)  
18 3/4"(476)  
14 3/4"(375)  
14"(366)  
8 15/32"(215)



CWA1814



CWA2014



CWA2414



CWA2814



CWA3014



CWA3214



CWA3614

21 11/32"(542)  
22 7/8"(581)  
18 3/4"(476)  
18"(457)  
12 15/32"(317)



CWA1818



CWA2018



CWA2418



CWA2818



CWA3018



CWA3218



CWA3618

23 11/32"(593)  
24 7/8"(632)  
20 3/4"(527)  
20"(508)  
14 15/32"(388)



CWA1820



CWA2020



CWA2420



CWA2820



CWA3020



CWA3220



CWA3620

27 11/32"(695)  
28 7/8"(733)  
24 3/4"(632)  
24"(610)  
18 15/32"(489)



CWA1824



CWA2024



CWA2424



CWA2824



CWA3024



CWA3224



CWA3624

31 11/32"(796)  
32 7/8"(835)  
28 3/4"(730)  
28"(711)  
22 15/32"(571)



CWA1828



CWA2028



CWA2428



CWA2828



CWA3028



CWA3228



CWA3628

33 11/32"(847)  
34 7/8"(885)  
30 3/4"(781)  
30"(762)  
24 15/32"(622)



CWA1830



CWA2030



CWA2430



CWA2830



CWA3030



CWA3230



CWA3630

35 11/32"(898)  
36 7/8"(937)  
32 3/4"(832)  
32"(813)  
26 15/32"(672)



CWA1832



CWA2032



CWA2432



CWA2832



CWA3032



CWA3232



CWA3632

39 11/32"(999)  
40 7/8"(1038)  
36 3/4"(933)  
36"(914)  
30 15/32"(774)



CWA1836



CWA2036



CWA2436



CWA2836



CWA3036



CWA3236



CWA3636

43 11/32"(1101)  
44 7/8"(1140)  
40 3/4"(1035)  
40"(1016)  
34 15/32"(876)



CWA1840



CWA2040



CWA2440



CWA2840



CWA3040



CWA3240



CWA3640

**ELEVATION SYMBOL LEGEND:**  
M.O. = MASORNY OPENING  
VALUES IN ( ) ARE IN MILLIMETER CONVERSIONS  
## NUMBER INDICATES PREFORMANCE GRADE (PG) RATING WITH STANDARD GLAZING

Note: Elevations shown include exterior sillnose and brickmold trim. Subtract 1/2"(12.7) from M.O.(Masonry Opening) for Unit Sizes. Masonry openings above include Sill Nose, see Trim Options page for Sill Nose specifications. For other Trim Options refer to the Unit Sizing, Rough Opening & Masonry Openings page.



**ELEVATIONS  
OPERATING UNITS**

MO BRICKMOLD  
MO FLAT CASING  
ROUGH OPENING  
FRAME SIZE  
DAYLIGHT OPENING

43 1/4"(1099)  
46 5/16"(1176)  
40 3/4"(1035)  
40"(1016)  
35 1/16"(891)

45 1/4"(1149)  
48 5/16"(1227)  
42 3/4"(1086)  
42"(1067)  
37 1/16"(941)

51 1/4"(1302)  
54 5/16"(1380)  
48 3/4"(1238)  
48"(1219)  
43 1/16"(1094)

57 1/4"(1454)  
60 5/16"(1532)  
54 3/4"(1391)  
54"(1372)  
49 1/16"(1246)

59 1/4"(1505)  
62 5/16"(1583)  
56 3/4"(1441)  
58"(1422)  
51 1/16"(1297)

35 1/16"(898)  
36 7/8"(937)  
32 3/4"(832)  
32"(813)  
26 15/32"(672)

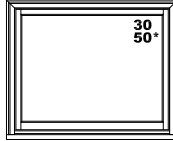

CWA4032

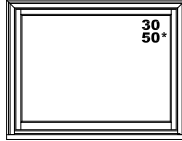

CWA4232

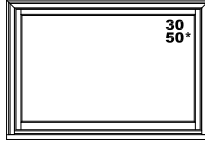

CWA4832

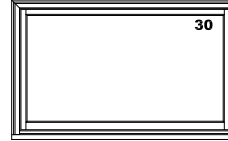

CWA5432



CWA5632

39 1/16"(989)  
40 7/8"(1038)  
38 3/4"(983)  
38"(964)  
30 15/32"(774)

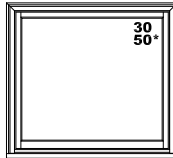

CWA4036

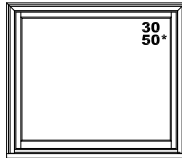

CWA4236

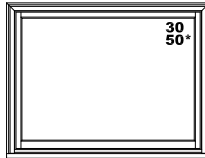

CWA4836



CWA5436



CWA5636

43 1/16"(1101)  
44 7/8"(1140)  
40 3/4"(1035)  
40"(1016)  
34 15/32"(876)

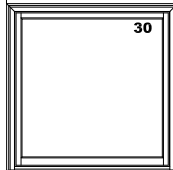

CWA4040

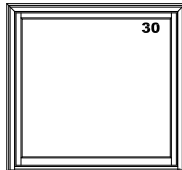

CWA4240

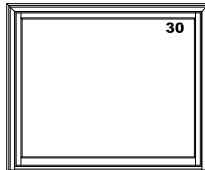

CWA4840

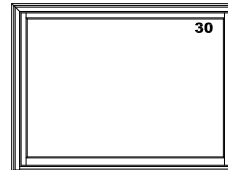

CWA5440

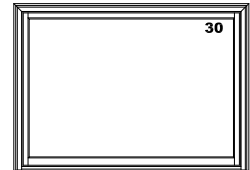

CWA5640

45 1/16"(1152)  
46 7/8"(1191)  
42 3/4"(1086)  
42"(1067)  
36 15/32"(926)

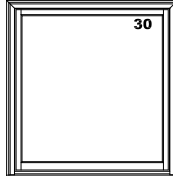

CWA4042

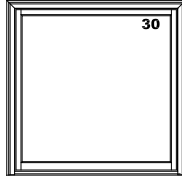

CWA4242

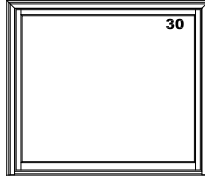

CWA4842

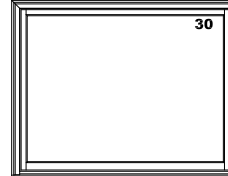

CWA5442



CWA5642

51 1/16"(1304)  
52 7/8"(1343)  
48 3/4"(1238)  
48"(1219)  
42 15/32"(1079)

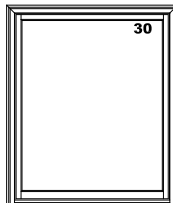

CWA4048

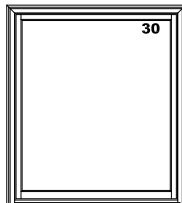

CWA4248

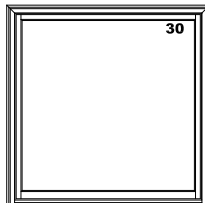

CWA4848

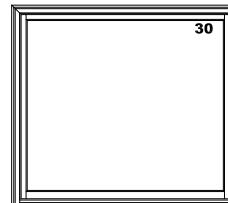

CWA5448

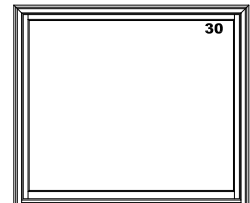

CWA5648

MO BRICKMOLD  
MO FLAT CASING  
ROUGH OPENING  
FRAME SIZE  
DAYLIGHT OPENING

63 1/4"(1607)  
66 5/16"(1684)  
60 3/4"(1543)  
60"(1524)  
55 1/16"(1399)

69 1/4"(1759)  
72 5/16"(1837)  
66 3/4"(1695)  
66"(1676)  
61 1/16"(1551)

75 1/4"(1911)  
78 5/16"(1989)  
72 3/4"(1848)  
72"(1829)  
67 1/16"(1703)

17 1/16"(441)  
18 7/8"(479)  
14 3/4"(375)  
14"(356)  
8 15/32"(215)

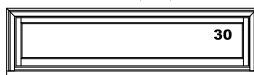

CWA6014



CWA6614

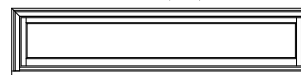

CWA7214

21 1/16"(542)  
22 7/8"(581)  
18 3/4"(476)  
18"(457)  
12 15/32"(317)



CWA6018



CWA6618



CWA7218

23 1/16"(593)  
24 7/8"(632)  
20 3/4"(527)  
20"(508)  
14 15/32"(368)



CWA6020



CWA6620



CWA7220

**ELEVATION SYMBOL LEGEND:**  
M.O. = MASONRY OPENING  
VALUES IN ( ) ARE IN MILLIMETER CONVERSIONS  
## NUMBER INDICATES PERFORMANCE GRADE (PG) RATING WITH STANDARD GLAZING

Note: Elevations shown include exterior sillnose and brickmold trim. Subtract 1/2"(12.7) from M.O.(Masonry Opening) for Unit Sizes. Masonry openings above include Sill Nose, see Trim Options page for Sill Nose specifications. For other Trim Options refer to the Unit Sizing, Rough Opening & Masonry Openings page.

**ELEVATIONS  
OPERATING UNITS**

MO BRICKMOLD  
MO FLAT CASING  
ROUGH OPENING  
FRAME SIZE  
DAYLIGHT OPENING

63 1/4"(1607)  
66 5/16"(1684)  
60 3/4"(1543)  
60"(1524)  
55 1/16"(1399)

69 1/4"(1759)  
72 5/16"(1837)  
66 3/4"(1695)  
66"(1676)  
61 1/16"(1551)

75 1/4"(1911)  
78 5/16"(1989)  
72 3/4"(1848)  
72"(1829)  
67 1/16"(1703)

27 1/2"(695)  
28 7/8"(733)  
24 3/4"(629)  
24 1/2"(610)  
18 15/32"(469)



CWA6024



CWA6624



CWA7224

31 1/2"(796)  
32 7/8"(845)  
28 3/4"(730)  
28 1/2"(711)  
22 15/32"(571)



CWA6028



CWA6628



CWA7228

33 1/2"(847)  
34 7/8"(896)  
30 3/4"(781)  
30 7/8"(782)  
24 15/32"(622)



CWA6030



CWA6630



CWA7230

35 1/2"(898)  
36 7/8"(937)  
32 3/4"(833)  
32 1/2"(813)  
26 15/32"(672)



CWA6032



CWA6632



CWA7232

39 1/2"(999)  
40 7/8"(1038)  
36 3/4"(933)  
36 1/2"(914)  
30 15/32"(774)



CWA6036



CWA6636



CWA7236

43 1/2"(1101)  
44 7/8"(1140)  
40 3/4"(1035)  
40 1/2"(1016)  
34 15/32"(876)

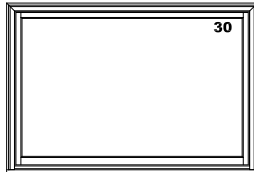

CWA6040



CWA6640

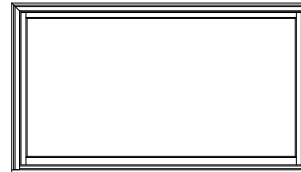

CWA7240

45 1/2"(1152)  
46 7/8"(1191)  
42 3/4"(1086)  
42 1/2"(1067)  
36 15/32"(926)

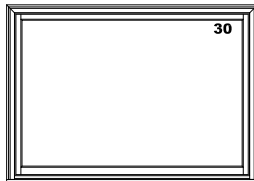

CWA6042

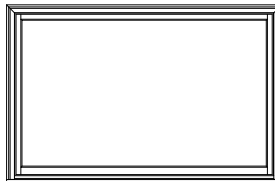

CWA6642

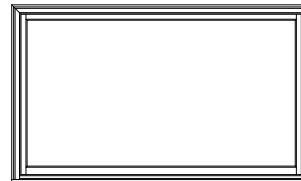

CWA7242

51 1/2"(1304)  
52 7/8"(1343)  
48 3/4"(1238)  
48 1/2"(1219)  
42 15/32"(1079)

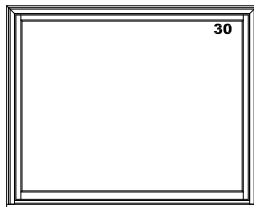

CWA6048



CWA6648



CWA7248

**ELEVATION SYMBOL LEGEND:**  
M.O. = MASONRY OPENING  
VALUES IN ( ) ARE IN MILLIMETER CONVERSIONS  
## NUMBER INDICATES PERFORMANCE GRADE (PG) RATING WITH STANDARD GLAZING

Note: Elevations shown include exterior sillnose and brickmold trim. Subtract 1/2"(12.7) from M.O.(Masonry Opening) for Unit Sizes. Masonry openings above include Sill Nose, see Trim Options page for Sill Nose specifications. For other Trim Options refer to the Unit Sizing, Rough Opening & Masonry Openings page.

ELEVATIONS  
STATIONARY UNITS

MO BRICKMOLD  
MO FLAT CASING  
ROUGH OPENING  
FRAME SIZE  
DAYLIGHT OPENING

21 1/4"(540)  
24 5/16"(618)  
18 3/4"(476)  
18"(457)  
13 1/16"(332)

23 1/4"(591)  
26 5/16"(668)  
20 3/4"(527)  
20"(508)  
15 1/16"(383)

27 1/4"(692)  
30 5/16"(770)  
24 3/4"(629)  
24"(610)  
19 1/16"(484)

31 1/4"(794)  
34 5/16"(872)  
28 3/4"(730)  
28"(711)  
23 1/16"(586)

33 1/4"(845)  
36 5/16"(922)  
30 3/4"(781)  
30"(762)  
25 1/16"(637)

35 1/4"(895)  
38 5/16"(973)  
32 3/4"(832)  
32"(813)  
27 1/16"(687)

39 1/4"(997)  
42 5/16"(1075)  
36 3/4"(933)  
36"(914)  
31 1/16"(789)

17 11/32"(441)  
18 7/8"(479)  
14 3/4"(375)  
14"(366)  
8 15/32"(215)



CWA1814



CWA2014



CWA2414

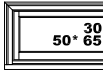

CWA2814

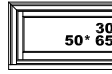

CWA3014

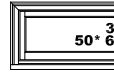

CWA3214

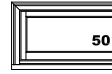

CWA3614

21 11/32"(542)  
22 7/8"(581)  
18 3/4"(476)  
18"(457)  
12 15/32"(317)



CWA1818



CWA2018



CWA2418

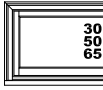

CWA2818

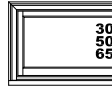

CWA3018

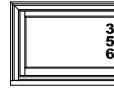

CWA3218

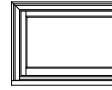

CWA3618

23 11/32"(593)  
24 7/8"(632)  
20 3/4"(527)  
20"(508)  
14 15/32"(368)



CWA1820



CWA2020



CWA2420

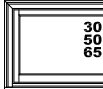

CWA2820

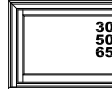

CWA3020

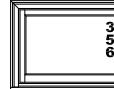

CWA3220

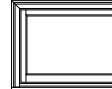

CWA3620

27 11/32"(695)  
28 7/8"(733)  
24 3/4"(629)  
24"(610)  
18 15/32"(469)



CWA1824



CWA2024



CWA2424



CWA2824



CWA3024



CWA3224



CWA3624

31 11/32"(796)  
32 7/8"(834)  
28 3/4"(730)  
28"(711)  
22 15/32"(571)



CWA1828



CWA2028



CWA2428



CWA2828



CWA3028



CWA3228



CWA3628

33 11/32"(847)  
34 7/8"(885)  
30 3/4"(781)  
30"(762)  
24 15/32"(622)



CWA1830



CWA2030



CWA2430



CWA2830



CWA3030



CWA3230



CWA3630

35 11/32"(898)  
36 7/8"(936)  
32 3/4"(832)  
32"(813)  
26 15/32"(672)



CWA1832



CWA2032



CWA2432



CWA2832



CWA3032



CWA3232



CWA3632

39 11/32"(999)  
40 7/8"(1037)  
36 3/4"(933)  
36"(914)  
30 15/32"(774)



CWA1836



CWA2036



CWA2436



CWA2836



CWA3036



CWA3236



CWA3636

43 11/32"(1101)  
44 7/8"(1140)  
40 3/4"(1035)  
40"(1016)  
34 15/32"(876)



CWA1840



CWA2040



CWA2440



CWA2840



CWA3040



CWA3240



CWA3640

ELEVATION SYMBOL LEGEND:  
M.O. = MASORNY OPENING  
VALUES IN ( ) ARE IN MILLIMETER CONVERSIONS  
## NUMBER INDICATES PREFORMANCE GRADE (PG) RATING WITH STANDARD GLAZING

Note: Elevations shown include exterior sillnose and brickmold trim. Subtract 1/2"(12.7) from M.O.(Masonry Opening) for Unit Sizes. Masonry openings above include Sill Nose, see Trim Options page for Sill Nose specifications. For other Trim Options refer to the Unit Sizing, Rough Opening & Masonry Openings page.



**ELEVATIONS  
STATIONARY UNITS**

MO BRICKMOLD  
MO FLAT CASING  
ROUGH OPENING  
FRAME SIZE  
DAYLIGHT OPENING

21 1/4"(540)  
24 5/16"(618)  
18 3/4"(476)  
18"(457)  
13 1/16"(332)

23 1/4"(591)  
26 5/16"(668)  
20 3/4"(527)  
20"(508)  
15 1/16"(383)

27 1/4"(692)  
30 5/16"(770)  
24 3/4"(629)  
24"(610)  
19 1/16"(484)

31 1/4"(794)  
34 5/16"(872)  
28 3/4"(730)  
28"(711)  
23 1/16"(586)

33 1/4"(845)  
36 5/16"(922)  
30 3/4"(781)  
30"(762)  
25 1/16"(637)

35 1/4"(895)  
38 5/16"(973)  
32 3/4"(832)  
32"(813)  
27 1/16"(687)

39 1/4"(997)  
42 5/16"(1075)  
36 3/4"(933)  
36"(914)  
31 1/16"(789)

45 11/32"(1152)  
46 7/8"(1191)  
42 3/4"(1086)  
42"(1067)  
36 15/32"(926)

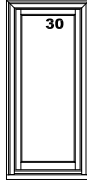

CWA1842

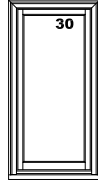

CWA2042

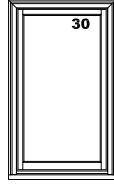

CWA2442



CWA2842

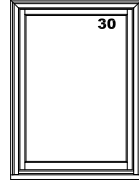

CWA3042

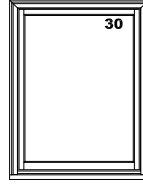

CWA3242

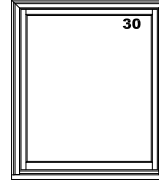

CWA3642

51 11/32"(1304)  
52 7/8"(1343)  
48 3/4"(1238)  
48"(1219)  
42 15/32"(1079)

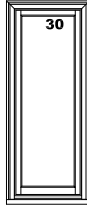

CWA1848

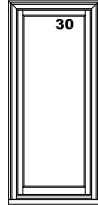

CWA2048

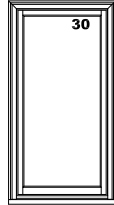

CWA2448

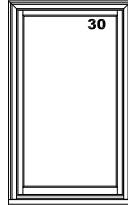

CWA2848

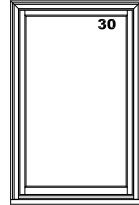

CWA3048

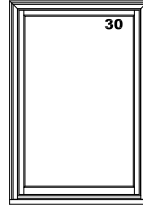

CWA3248

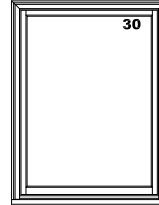

CWA3648

MO BRICKMOLD  
MO FLAT CASING  
ROUGH OPENING  
FRAME SIZE  
DAYLIGHT OPENING

43 1/4"(1099)  
46 5/16"(1176)  
40 3/4"(1035)  
40"(1016)  
35 1/16"(891)

45 1/4"(1149)  
48 5/16"(1227)  
42 3/4"(1086)  
42"(1067)  
37 1/16"(941)

51 1/4"(1302)  
54 5/16"(1380)  
48 3/4"(1238)  
48"(1219)  
43 1/16"(1094)

57 1/4"(1454)  
60 5/16"(1532)  
54 3/4"(1391)  
54"(1372)  
49 1/16"(1246)

59 1/4"(1505)  
62 5/16"(1583)  
56 3/4"(1441)  
56"(1422)  
51 1/16"(1297)

17 11/32"(441)  
18 7/8"(479)  
14 3/4"(375)  
14"(356)  
8 15/32"(215)



CWA4014



CWA4214



CWA4814



CWA5414



CWA5614

21 11/32"(542)  
22 7/8"(581)  
18 3/4"(476)  
18"(457)  
12 15/32"(317)

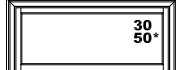

CWA4018

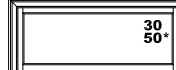

CWA4218



CWA4818

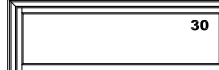

CWA5418

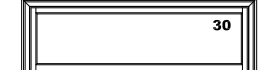

CWA5618

23 11/32"(603)  
24 7/8"(642)  
20 3/4"(527)  
20"(508)  
14 15/32"(368)



CWA4020



CWA4220



CWA4820



CWA5420



CWA5620

27 11/32"(695)  
28 7/8"(733)  
24 3/4"(629)  
24"(610)  
18 15/32"(469)



CWA4024



CWA4224



CWA4824



CWA5424



CWA5624

31 11/32"(786)  
32 7/8"(825)  
28 3/4"(730)  
28"(711)  
22 15/32"(571)



CWA4028



CWA4228



CWA4828



CWA5428

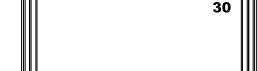

CWA5628

33 11/32"(847)  
34 7/8"(886)  
30 3/4"(781)  
30"(762)  
24 15/32"(622)



CWA4030



CWA4230



CWA4830



CWA5430



CWA5630

**ELEVATION SYMBOL LEGEND:**  
M.O. = MASORNY OPENING  
VALUES IN ( ) ARE IN MILLIMETER CONVERSIONS  
## NUMBER INDICATES PERFORMANCE GRADE (PG) RATING WITH STANDARD GLAZING

Note: Elevations shown include exterior sillnose and brickmold trim. Subtract 1/2"(12.7) from M.O.(Masonry Opening) for Unit Sizes. Masonry openings above include Sill Nose, see Trim Options page for Sill Nose specifications. For other Trim Options refer to the Unit Sizing, Rough Opening & Masonry Openings page.

**ELEVATIONS  
STATIONARY UNITS**

MO BRICKMOLD  
MO FLAT CASING  
ROUGH OPENING  
FRAME SIZE  
DAYLIGHT OPENING

43 1/4"(1099)  
46 5/16"(1176)  
40 3/4"(1035)  
40"(1016)  
35 1/16"(891)

45 1/4"(1149)  
48 5/16"(1227)  
42 3/4"(1086)  
42"(1067)  
37 1/16"(941)

51 1/4"(1302)  
54 5/16"(1380)  
48 3/4"(1238)  
48"(1219)  
43 1/16"(1094)

57 1/4"(1454)  
60 5/16"(1532)  
54 3/4"(1391)  
54"(1372)  
49 1/16"(1246)

59 1/4"(1505)  
62 5/16"(1583)  
56 3/4"(1441)  
58"(1422)  
51 1/16"(1297)

35 11/32"(898)  
36 7/8"(937)  
32 3/4"(832)  
32"(813)  
26 15/32"(672)

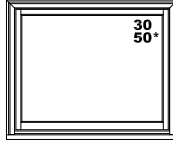

CWA4032

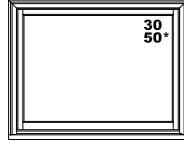

CWA4232

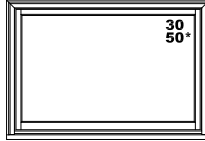

CWA4832



CWA5432

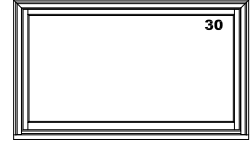

CWA5632

39 11/32"(999)  
40 7/8"(1038)  
38 3/4"(933)  
38"(914)  
30 15/32"(774)

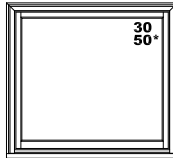

CWA4036

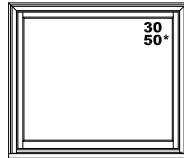

CWA4236

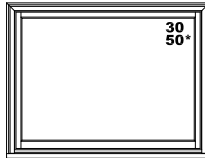

CWA4836



CWA5436



CWA5636

43 11/32"(1101)  
44 7/8"(1140)  
40 3/4"(1035)  
40"(1016)  
34 15/32"(876)

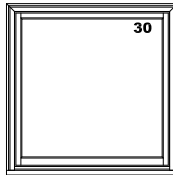

CWA4040

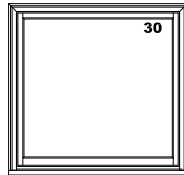

CWA4240

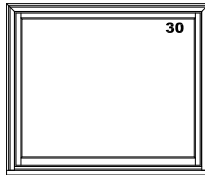

CWA4840

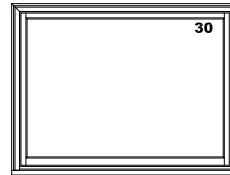

CWA5440

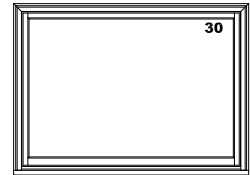

CWA5640

45 11/32"(1152)  
46 7/8"(1191)  
42 3/4"(1086)  
42"(1067)  
36 15/32"(926)

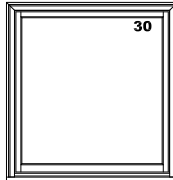

CWA4042

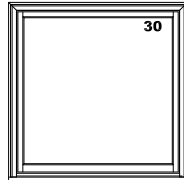

CWA4242

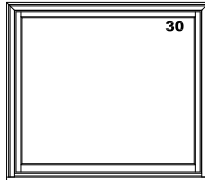

CWA4842

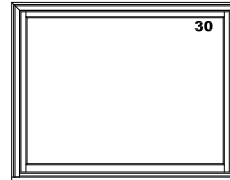

CWA5442

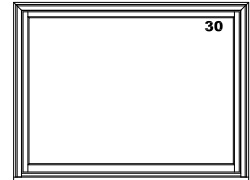

CWA5642

51 11/32"(1304)  
52 7/8"(1343)  
48 3/4"(1238)  
48"(1219)  
42 15/32"(1079)

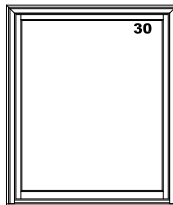

CWA4048

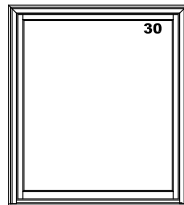

CWA4248

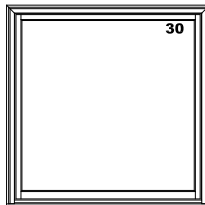

CWA4848

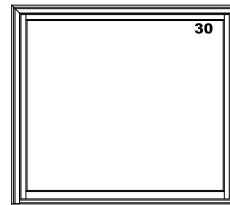

CWA5448

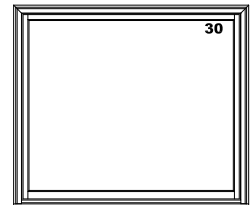

CWA5648

MO BRICKMOLD  
MO FLAT CASING  
ROUGH OPENING  
FRAME SIZE  
DAYLIGHT OPENING

63 1/4"(1607)  
66 5/16"(1684)  
60 3/4"(1543)  
60"(1524)  
55 1/16"(1399)

69 1/4"(1759)  
72 5/16"(1837)  
66 3/4"(1695)  
66"(1676)  
61 1/16"(1551)

75 1/4"(1911)  
78 5/16"(1989)  
72 3/4"(1848)  
72"(1829)  
67 1/16"(1703)

17 11/32"(441)  
18 7/8"(479)  
14 3/4"(375)  
14"(356)  
8 15/32"(215)



CWA6014



CWA6614



CWA7214

21 11/32"(542)  
22 7/8"(581)  
18 3/4"(476)  
18"(457)  
12 15/32"(317)



CWA6018



CWA6618



CWA7218

23 11/32"(693)  
24 7/8"(732)  
20 3/4"(527)  
20"(508)  
14 15/32"(368)

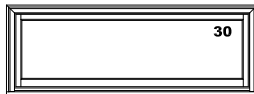

CWA6020

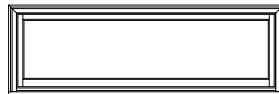

CWA6620

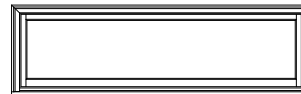

CWA7220

**ELEVATION SYMBOL LEGEND:**  
M.O. = MASORNY OPENING  
VALUES IN ( ) ARE IN MILLIMETER CONVERSIONS  
## NUMBER INDICATES PREFORMANCE GRADE (PG) RATING WITH STANDARD GLAZING

Note: Elevations shown include exterior sillnose and brickmold trim. Subtract 1/2"(12.7) from M.O.(Masonry Opening) for Unit Sizes. Masonry openings above include Sill Nose, see Trim Options page for Sill Nose specifications. For other Trim Options refer to the Unit Sizing, Rough Opening & Masonry Openings page.

**ELEVATIONS  
STATIONARY UNITS**

MO BRICKMOLD  
MO FLAT CASING  
ROUGH OPENING  
FRAME SIZE  
DAYLIGHT OPENING

63 1/4"(1607)  
66 5/16"(1684)  
60 3/4"(1543)  
60"(1524)  
55 1/16"(1399)

69 1/4"(1759)  
72 5/16"(1837)  
66 3/4"(1695)  
66"(1676)  
61 1/16"(1551)

75 1/4"(1911)  
78 5/16"(1989)  
72 3/4"(1848)  
72"(1829)  
67 1/16"(1703)

27 1/2"(695)  
28 7/8"(733)  
24 3/4"(629)  
24"(610)  
18 15/32"(469)



CWA6024



CWA6624



CWA7224

31 1/2"(796)  
32 7/8"(845)  
28 3/4"(730)  
28"(711)  
22 15/32"(571)



CWA6028



CWA6628



CWA7228

33 1/2"(847)  
34 7/8"(896)  
30 3/4"(781)  
30"(762)  
24 15/32"(622)



CWA6030



CWA6630



CWA7230

35 1/2"(898)  
36 7/8"(937)  
32 3/4"(833)  
32"(813)  
26 15/32"(672)



CWA6032



CWA6632



CWA7232

39 1/2"(999)  
40 7/8"(1038)  
36 3/4"(933)  
36"(914)  
30 15/32"(774)



CWA6036



CWA6636



CWA7236

43 1/2"(1101)  
44 7/8"(1140)  
40 3/4"(1035)  
40"(1016)  
34 15/32"(876)



CWA6040

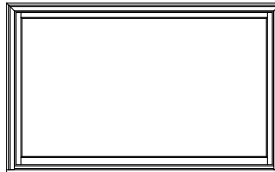

CWA6640



CWA7240

45 1/2"(1152)  
46 7/8"(1191)  
42 3/4"(1086)  
42"(1067)  
36 15/32"(926)

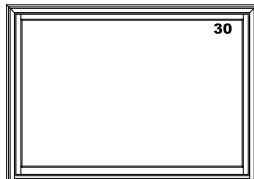

CWA6042



CWA6642

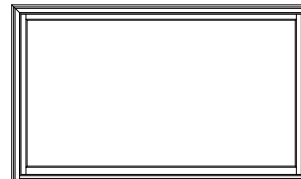

CWA7242

51 1/2"(1304)  
52 7/8"(1343)  
48 3/4"(1238)  
48"(1219)  
42 15/32"(1079)

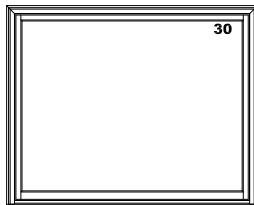

CWA6048



CWA6648



CWA7248

**ELEVATION SYMBOL LEGEND:**  
M.O. = MASONRY OPENING  
VALUES IN ( ) ARE IN MILLIMETER CONVERSIONS  
## NUMBER INDICATES PERFORMANCE GRADE (PG) RATING WITH STANDARD GLAZING

Note: Elevations shown include exterior sillnose and brickmold trim. Subtract 1/2"(12.7) from M.O.(Masonry Opening) for Unit Sizes. Masonry openings above include Sill Nose, see Trim Options page for Sill Nose specifications. For other Trim Options refer to the Unit Sizing, Rough Opening & Masonry Openings page.

**ELEVATIONS  
2-WIDE 1- HIGH**

	MO BRICKMOLD MO FLAT CASING ROUGH OPENING FRAME SIZE DAYLIGHT OPENING	39 1/4"(997) 42 5/16"(1075) 36 3/4"(933) 36"(914) 13 1/16"(332) [2]	43 1/4"(1099) 46 5/16"(1176) 40 3/4"(1035) 40"(1016) 15 1/16"(383) [2]	51 1/4"(1302) 54 5/16"(1380) 48 3/4"(1238) 48"(1219) 19 1/16"(484) [2]	59 1/4"(1505) 62 5/16"(1583) 56 3/4"(1441) 56"(1422) 23 1/16"(586) [2]	63 1/4"(1607) 66 5/16"(1684) 60 3/4"(1543) 60"(1524) 25 1/16"(637) [2]	67 1/4"(1708) 70 5/16"(1786) 64 3/4"(1645) 64"(1626) 27 1/16"(687) [2]
21 11/32"(642) 22 7/8"(591) 1 9/16"(476) 12 15/32"(317)	17 11/32"(441) 16 7/8"(479) 14 3/4"(375) 13 5/8" 8 15/32"(215)						
	23 11/32"(653) 24 7/8"(632) 20 3/4"(527) 21 1/2"(546) 18 15/32"(468) [2]						
	27 11/32"(706) 28 7/8"(733) 24 3/4"(629) 24 1/2"(610) 18 15/32"(468) [2]						
	31 11/32"(796) 32 7/8"(833) 28 3/4"(730) 24 1/2"(610) 22 15/32"(582)						
	33 11/32"(847) 34 7/8"(886) 30 3/4"(781) 30 1/2"(762) 24 15/32"(622)						
	35 11/32"(898) 36 7/8"(937) 32 3/4"(832) 32 1/2"(813) 26 15/32"(672)						

**ELEVATION SYMBOL LEGEND:**  
M.O. = MASORNY OPENING  
VALUES IN ( ) ARE IN MILLIMETER CONVERSIONS

Note: Elevations shown include exterior sillnose and brickmold trim. Subtract 1/2"(12.7) from M.O.(Masonry Opening) for Unit Sizes. Masonry openings above include Sill Nose, see Trim Options page for Sill Nose specifications. For other Trim Options refer to the Unit Sizing, Rough Opening & Masonry Openings page.

ELEVATIONS  
2-WIDE 1-HIGH

MO BRICKMOLD	75 1/4"(1911)	83 1/4"(2115)	87 1/4"(2216)	99 1/4"(2521)
MO FLAT CASING	78 5/16"(1989)	86 5/16"(2192)	90 5/16"(2294)	102 5/16"(2599)
ROUGH OPENING	72 3/4"(1848)	80 3/4"(2051)	84 3/4"(2153)	96 3/4"(2457)
FRAME SIZE	72"(1829)	80"(2032)	84"(2134)	96"(2438)
DAYLIGHT OPENING	31 1/16"(789) [2]	35 1/16"(789) [2]	37 1/16"(941) [2]	43 1/16"(1094) [2]
21 11/32"(642)				
22 7/8"(591)				
24 3/4"(635)				
26 1/2"(665)				
28 1/2"(725)				
30 3/4"(785)				
32 1/2"(835)				
34 3/4"(895)				
36 1/2"(925)				
38 1/2"(985)				
40 3/4"(1035)				
42 1/2"(1075)				

**ELEVATION SYMBOL LEGEND:**  
M.O. = MASORNY OPENING  
VALUES IN ( ) ARE IN MILLIMETER CONVERSIONS

Note: Elevations shown include exterior sillnose and brickmold trim. Subtract 1/2"(12.7) from M.O.(Masonry Opening) for Unit Sizes. Masonry openings above include Sill Nose, see Trim Options page for Sill Nose specifications. For other Trim Options refer to the Unit Sizing, Rough Opening & Masonry Openings page.

**ELEVATIONS**  
**2-HIGH 1-WIDE**

	33 1/4"(845)	35 1/4"(895)	39 1/4"(997)	43 1/4"(1099)	45 1/4"(1149)	51 1/4"(1302)
MO BRICKMOLD	36 5/16"(922)	38 5/16"(973)	42 5/16"(1075)	46 5/16"(1176)	48 5/16"(1227)	54 5/16"(1380)
MO FLAT CASING	30 3/4"(781)	32 3/4"(832)	36 3/4"(933)	40 3/4"(1035)	42 3/4"(1086)	48 3/4"(1238)
ROUGH OPENING	30"(762)	32"(813)	36"(914)	40"(1016)	42"(1067)	48"(1219)
FRAME SIZE	25 1/16"(637)	27 1/16"(687)	31 1/16"(789)	35 1/16"(891)	37 1/16"(941)	43 1/16"(1094)
DAYLIGHT OPENING						
39 11/32"(786) 40 7/8"(1038) 36 3/4"(933) 36"(914) 12 15/32"(215) [2]						
43 11/32"(1101) 44 7/8"(1140) 40 3/4"(1035) 40"(1016) 14 15/32"(366) [2]						
51 11/32"(1304) 52 7/8"(1343) 48 3/4"(1238) 48"(1219) 18 15/32"(469) [2]						
59 11/32"(1507) 60 7/8"(1546) 56 3/4"(1441) 56"(1422) 22 15/32"(571) [2]						
63 11/32"(1609) 64 7/8"(1648) 60 3/4"(1543) 60"(1524) 24 15/32"(622) [2]						
67 11/32"(1711) 68 7/8"(1749) 64 3/4"(1645) 64"(1626) 26 15/32"(672) [2]						
75 11/32"(1914) 76 7/8"(1953) 72 3/4"(1848) 72"(1829) 30 15/32"(774) [2]						
83 11/32"(2117) 84 7/8"(2156) 80 3/4"(2051) 80"(2032) 34 15/32"(876) [2]						

**ELEVATION SYMBOL LEGEND:**  
M.O. = MASORNY OPENING  
VALUES IN ( ) ARE IN MILLIMETER CONVERSIONS

Note: Elevations shown include exterior sillnose and brickmold trim. Subtract 1/2"(12.7) from M.O.(Masonry Opening) for Unit Sizes. Masonry openings above include Sill Nose, see Trim Options page for Sill Nose specifications. For other Trim Options refer to the Unit Sizing, Rough Opening & Masonry Openings page.

**ELEVATIONS**  
**2-HIGH 1-WIDE**

MO BRICKMOLD	33 1/4"(845)	35 1/4"(895)	39 1/4"(997)	43 1/4"(1099)	45 1/4"(1149)	51 1/4"(1302)
MO FLAT CASING	36 5/16"(922)	38 5/16"(973)	42 5/16"(1075)	46 5/16"(1176)	48 5/16"(1227)	54 5/16"(1380)
ROUGH OPENING	30 3/4"(781)	32 3/4"(832)	36 3/4"(933)	40 3/4"(1035)	42 3/4"(1086)	48 3/4"(1238)
FRAME SIZE	30"(762)	32"(813)	36"(914)	40"(1016)	42"(1067)	48"(1219)
DAYLIGHT OPENING	25 1/16"(637)	27 1/16"(687)	31 1/16"(789)	35 1/16"(891)	37 1/16"(941)	43 1/16"(1094)

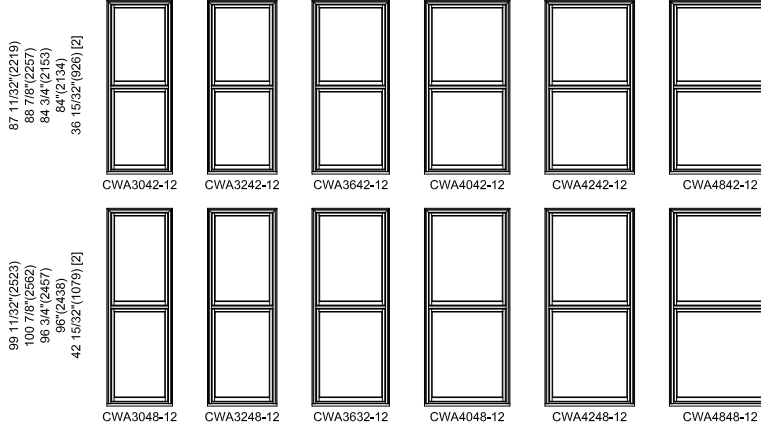

**ELEVATION SYMBOL LEGEND:**  
M.O. = MASORNY OPENING  
VALUES IN ( ) ARE IN MILLIMETER CONVERSIONS

Note: Elevations shown include exterior sillnose and brickmold trim. Subtract 1/2"(12.7) from M.O.(Masonry Opening) for Unit Sizes. Masonry openings above include Sill Nose, see Trim Options page for Sill Nose specifications. For other Trim Options refer to the Unit Sizing, Rough Opening & Masonry Openings page.

**ELEVATIONS  
2-WIDE 2-HIGH**

	63 1/4"(1607)	67 1/4"(1708)	75 1/4"(1911)	83 1/4"(2115)	87 1/4"(2216)	87 1/4"(2216)
MO BRICKMOLD	66 5/16"(1684)	70 5/16"(1786)	78 5/16"(1989)	86 5/16"(2192)	90 5/16"(2294)	90 5/16"(2294)
MO FLAT CASING	60 3/4"(1543)	64 3/4"(1645)	72 3/4"(1848)	80 3/4"(2051)	84 3/4"(2153)	84 3/4"(2051)
ROUGH OPENING	60"(1524)	64"(1626)	72"(1829)	80"(2032)	84"(2134)	84"(2134)
FRAME SIZE	25 1/16"(637) [2]	27 1/16"(687) [2]	31 1/16"(789) [2]	35 1/16"(789) [2]	37 1/16"(941) [2]	37 1/16"(941) [2]
DAYLIGHT OPENING	39 11/32"(796)	40 7/8"(1036)	40 7/8"(1036)	40 7/8"(1036)	40 7/8"(1036)	40 7/8"(1036)
	40 7/8"(1036)	40 7/8"(1036)	40 7/8"(1036)	40 7/8"(1036)	40 7/8"(1036)	40 7/8"(1036)
	36 3/4"(933)	36 3/4"(933)	36 3/4"(933)	36 3/4"(933)	36 3/4"(933)	36 3/4"(933)
	36 3/4"(933)	36 3/4"(933)	36 3/4"(933)	36 3/4"(933)	36 3/4"(933)	36 3/4"(933)
	36 3/4"(933)	36 3/4"(933)	36 3/4"(933)	36 3/4"(933)	36 3/4"(933)	36 3/4"(933)
	12 15/32"(215) [2]	12 15/32"(215) [2]	12 15/32"(215) [2]	12 15/32"(215) [2]	12 15/32"(215) [2]	12 15/32"(215) [2]
	43 11/32"(1101)	44 7/8"(1140)	44 7/8"(1140)	44 7/8"(1140)	44 7/8"(1140)	44 7/8"(1140)
	44 7/8"(1140)	44 7/8"(1140)	44 7/8"(1140)	44 7/8"(1140)	44 7/8"(1140)	44 7/8"(1140)
	40 3/4"(1035)	40 3/4"(1035)	40 3/4"(1035)	40 3/4"(1035)	40 3/4"(1035)	40 3/4"(1035)
	40 3/4"(1035)	40 3/4"(1035)	40 3/4"(1035)	40 3/4"(1035)	40 3/4"(1035)	40 3/4"(1035)
	40 3/4"(1035)	40 3/4"(1035)	40 3/4"(1035)	40 3/4"(1035)	40 3/4"(1035)	40 3/4"(1035)
	14 15/32"(368) [2]	14 15/32"(368) [2]	14 15/32"(368) [2]	14 15/32"(368) [2]	14 15/32"(368) [2]	14 15/32"(368) [2]
	51 11/32"(1304)	52 7/8"(1343)	52 7/8"(1343)	52 7/8"(1343)	52 7/8"(1343)	52 7/8"(1343)
	52 7/8"(1343)	52 7/8"(1343)	52 7/8"(1343)	52 7/8"(1343)	52 7/8"(1343)	52 7/8"(1343)
	48 3/4"(1238)	48 3/4"(1238)	48 3/4"(1238)	48 3/4"(1238)	48 3/4"(1238)	48 3/4"(1238)
	48 3/4"(1238)	48 3/4"(1238)	48 3/4"(1238)	48 3/4"(1238)	48 3/4"(1238)	48 3/4"(1238)
	48 3/4"(1238)	48 3/4"(1238)	48 3/4"(1238)	48 3/4"(1238)	48 3/4"(1238)	48 3/4"(1238)
	18 15/32"(469) [2]	18 15/32"(469) [2]	18 15/32"(469) [2]	18 15/32"(469) [2]	18 15/32"(469) [2]	18 15/32"(469) [2]
	59 11/32"(1507)	60 7/8"(1546)	60 7/8"(1546)	60 7/8"(1546)	60 7/8"(1546)	60 7/8"(1546)
	60 7/8"(1546)	60 7/8"(1546)	60 7/8"(1546)	60 7/8"(1546)	60 7/8"(1546)	60 7/8"(1546)
	56 3/4"(1441)	56 3/4"(1441)	56 3/4"(1441)	56 3/4"(1441)	56 3/4"(1441)	56 3/4"(1441)
	56 3/4"(1441)	56 3/4"(1441)	56 3/4"(1441)	56 3/4"(1441)	56 3/4"(1441)	56 3/4"(1441)
	56 3/4"(1441)	56 3/4"(1441)	56 3/4"(1441)	56 3/4"(1441)	56 3/4"(1441)	56 3/4"(1441)
	22 15/32"(571) [2]	22 15/32"(571) [2]	22 15/32"(571) [2]	22 15/32"(571) [2]	22 15/32"(571) [2]	22 15/32"(571) [2]
	63 11/32"(1609)	64 7/8"(1648)	64 7/8"(1648)	64 7/8"(1648)	64 7/8"(1648)	64 7/8"(1648)
	64 7/8"(1648)	64 7/8"(1648)	64 7/8"(1648)	64 7/8"(1648)	64 7/8"(1648)	64 7/8"(1648)
	60 3/4"(1543)	60 3/4"(1543)	60 3/4"(1543)	60 3/4"(1543)	60 3/4"(1543)	60 3/4"(1543)
	60 3/4"(1543)	60 3/4"(1543)	60 3/4"(1543)	60 3/4"(1543)	60 3/4"(1543)	60 3/4"(1543)
	60 3/4"(1543)	60 3/4"(1543)	60 3/4"(1543)	60 3/4"(1543)	60 3/4"(1543)	60 3/4"(1543)
	24 15/32"(622) [2]	24 15/32"(622) [2]	24 15/32"(622) [2]	24 15/32"(622) [2]	24 15/32"(622) [2]	24 15/32"(622) [2]
	67 11/32"(1711)	68 7/8"(1749)	68 7/8"(1749)	68 7/8"(1749)	68 7/8"(1749)	68 7/8"(1749)
	68 7/8"(1749)	68 7/8"(1749)	68 7/8"(1749)	68 7/8"(1749)	68 7/8"(1749)	68 7/8"(1749)
	64 3/4"(1645)	64 3/4"(1645)	64 3/4"(1645)	64 3/4"(1645)	64 3/4"(1645)	64 3/4"(1645)
	64 3/4"(1645)	64 3/4"(1645)	64 3/4"(1645)	64 3/4"(1645)	64 3/4"(1645)	64 3/4"(1645)
	64 3/4"(1645)	64 3/4"(1645)	64 3/4"(1645)	64 3/4"(1645)	64 3/4"(1645)	64 3/4"(1645)
	26 15/32"(672) [2]	26 15/32"(672) [2]	26 15/32"(672) [2]	26 15/32"(672) [2]	26 15/32"(672) [2]	26 15/32"(672) [2]
	75 11/32"(1914)	76 7/8"(1953)	76 7/8"(1953)	76 7/8"(1953)	76 7/8"(1953)	76 7/8"(1953)
	76 7/8"(1953)	76 7/8"(1953)	76 7/8"(1953)	76 7/8"(1953)	76 7/8"(1953)	76 7/8"(1953)
	72 3/4"(1848)	72 3/4"(1848)	72 3/4"(1848)	72 3/4"(1848)	72 3/4"(1848)	72 3/4"(1848)
	72 3/4"(1848)	72 3/4"(1848)	72 3/4"(1848)	72 3/4"(1848)	72 3/4"(1848)	72 3/4"(1848)
	72 3/4"(1848)	72 3/4"(1848)	72 3/4"(1848)	72 3/4"(1848)	72 3/4"(1848)	72 3/4"(1848)
	30 15/32"(774) [2]	30 15/32"(774) [2]	30 15/32"(774) [2]	30 15/32"(774) [2]	30 15/32"(774) [2]	30 15/32"(774) [2]
	83 11/32"(2117)	84 7/8"(2156)	84 7/8"(2156)	84 7/8"(2156)	84 7/8"(2156)	84 7/8"(2156)
	84 7/8"(2156)	84 7/8"(2156)	84 7/8"(2156)	84 7/8"(2156)	84 7/8"(2156)	84 7/8"(2156)
	80 3/4"(2051)	80 3/4"(2051)	80 3/4"(2051)	80 3/4"(2051)	80 3/4"(2051)	80 3/4"(2051)
	80 3/4"(2051)	80 3/4"(2051)	80 3/4"(2051)	80 3/4"(2051)	80 3/4"(2051)	80 3/4"(2051)
	80 3/4"(2051)	80 3/4"(2051)	80 3/4"(2051)	80 3/4"(2051)	80 3/4"(2051)	80 3/4"(2051)
	34 15/32"(876) [2]	34 15/32"(876) [2]	34 15/32"(876) [2]	34 15/32"(876) [2]	34 15/32"(876) [2]	34 15/32"(876) [2]

**ELEVATION SYMBOL LEGEND:**  
M.O. = MASORNY OPENING  
VALUES IN ( ) ARE IN MILLIMETER CONVERSIONS

Note: Elevations shown include exterior sillnose and brickmold trim. Subtract 1/2"(12.7) from M.O.(Masonry Opening) for Unit Sizes. Masonry openings above include Sill Nose, see Trim Options page for Sill Nose specifications. For other Trim Options refer to the Unit Sizing, Rough Opening & Masonry Openings page.



**ELEVATIONS  
2-WIDE 2-HIGH**

MO BRICKMOLD	63 1/4"(1607)	67 1/4"(1708)	75 1/4"(1911)	83 1/4"(2115)	87 1/4"(2216)	87 1/4"(2216)
MO FLAT CASING	66 5/16"(1684)	70 5/16"(1786)	78 5/16"(1989)	86 5/16"(2192)	90 5/16"(2294)	90 5/16"(2294)
ROUGH OPENING	60 3/4"(1543)	64 3/4"(1645)	72 3/4"(1848)	80 3/4"(2051)	84 3/4"(2153)	84 3/4"(2051)
FRAME SIZE	60"(1524)	64"(1626)	72"(1829)	80"(2032)	84"(2134)	84"(2134)
DAYLIGHT OPENING	25 1/16"(637) [2]	27 1/16"(687) [2]	31 1/16"(789) [2]	35 1/16"(789) [2]	37 1/16"(941) [2]	13 1/16"(332) [2]

87 11/32"(2219)  
88 7/8"(2257)  
84 3/4"(2153)  
84 1/2"(34)  
36 15/32"(926) [2]

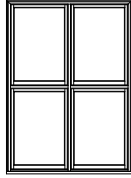

CWA3042-22

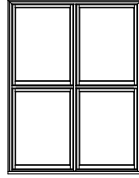

CWA3242-22

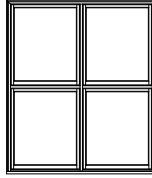

CWA3642-22

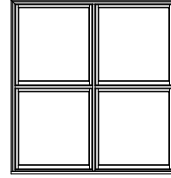

CWA4042-22

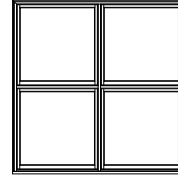

CWA4242-22

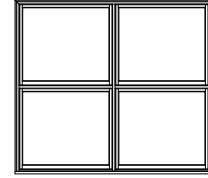

CWA4842-22

99 11/32"(2523)  
100 7/8"(2562)  
96 3/4"(2457)  
96"(2438)  
42 15/32"(1079) [2]

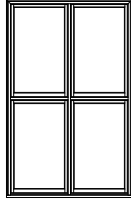

CWA3048-22

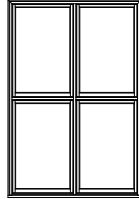

CWA3248-22

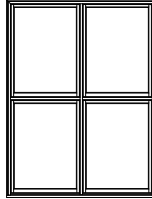

CWA3648-22

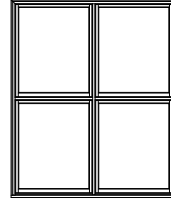

CWA4048-22

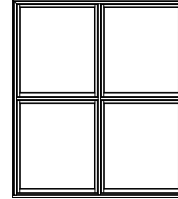

CWA4248-22

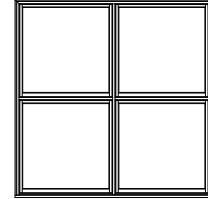

CWA4848-22

**ELEVATION SYMBOL LEGEND:**  
M.O. = MASORNY OPENING  
VALUES IN ( ) ARE IN MILLIMETER CONVERSIONS

Note: Elevations shown include exterior sillnose and brickmold trim. Subtract 1/2"(12.7) from M.O.(Masonry Opening) for Unit Sizes. Masonry openings above include Sill Nose, see Trim Options page for Sill Nose specifications. For other Trim Options refer to the Unit Sizing, Rough Opening & Masonry Openings page.

**ELEVATIONS  
30" WIDE X 36" HIGH PICTURE/AWNING  
COMBINATION**

MO BRICKMOLD	33 1/4"(845)	63 1/4"(1607)
MO FLAT CASING	36 5/16"(922)	66 5/16"(1684)
ROUGH OPENING	30 3/4"(781)	60 3/4"(1543)
FRAME SIZE	30"(762)	60"(1524)
DAYLIGHT OPENING	25 1/16"(637)	25 1/16"(637) [2]

57 11/32"(1457) 56 7/8"(1495) 54 3/4"(1391) 54"(1372) 30 15/32"(774) [1] 12 15/32"(317) [1]		
CWAP303618	CWAP303618-2	
59 11/32"(1507) 60 7/8"(1546) 56 3/4"(1441) 56"(1422) 30 15/32"(774) [1] 14 15/32"(368) [1]		
CWAP303620	CWAP303620-2	
63 11/32"(1609) 64 7/8"(1648) 60 3/4"(1543) 60"(1543) 30 15/32"(774) [1] 18 15/32"(469) [1]		
CWAP303624	CWAP303624-2	
67 11/32"(1711) 68 7/8"(1749) 64 3/4"(1645) 64"(1626) 30 15/32"(774) [1] 22 15/32"(571) [1]		
CWAP303628	CWAP303628-2	
69 11/32"(1761) 70 7/8"(1800) 66 3/4"(1695) 66"(1676) 30 15/32"(774) [1] 24 15/32"(622) [1]		
CWAP303630	CWAP303630-2	

**ELEVATION SYMBOL LEGEND:**  
M.O. = MASORNY OPENING  
VALUES IN ( ) ARE IN MILLIMETER CONVERSIONS

Note: Elevations shown include exterior sillnose and brickmold trim. Subtract 1/2"(12.7) from M.O.(Masonry Opening) for Unit Sizes. Masonry openings above include Sill Nose, see Trim Options page for Sill Nose specifications. For other Trim Options refer to the Unit Sizing, Rough Opening & Masonry Openings page.

**ELEVATIONS  
30" WIDE X 40" HIGH PICTURE/AWNING  
COMBINATION**

MO BRICKMOLD	33 1/4"(845)	63 1/4"(1607)
MO FLAT CASING	36 5/16"(922)	66 5/16"(1684)
ROUGH OPENING	30 3/4"(781)	60 3/4"(1543)
FRAME SIZE	30"(762)	60"(1524)
DAYLIGHT OPENING	25 1/16"(637)	25 1/16"(637) [2]

61 11/32"(1558)  
62 7/8"(1597)  
58 3/4"(1492)  
56"(1473)  
34 15/32"(876) [1]  
12 15/32"(317) [1]

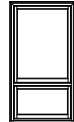

CWAP304018

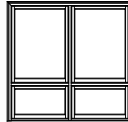

CWAP304018-2

63 11/32"(1609)  
64 7/8"(1648)  
60 3/4"(1543)  
60"(1524)  
34 15/32"(876) [1]  
14 15/32"(368) [1]

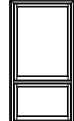

CWAP304020

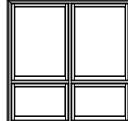

CWAP304020-2

67 11/32"(1711)  
68 7/8"(1749)  
64 3/4"(1645)  
64"(1626)  
34 15/32"(876) [1]  
18 15/32"(469) [1]

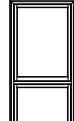

CWAP304024

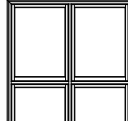

CWAP304024-2

71 11/32"(1812)  
72 7/8"(1851)  
68 3/4"(1746)  
68"(1727)  
34 15/32"(876) [1]  
22 15/32"(571) [1]

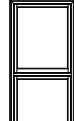

CWAP304028

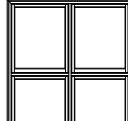

CWAP304028-2

73 11/32"(1863)  
74 7/8"(1902)  
70 3/4"(1797)  
70"(1778)  
34 15/32"(876) [1]  
24 15/32"(622) [1]



CWAP304030

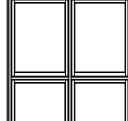

CWAP304030-2

**ELEVATION SYMBOL LEGEND:**  
M.O. = MASORNY OPENING  
VALUES IN ( ) ARE IN MILLIMETER CONVERSIONS

Note: Elevations shown include exterior sillnose and brickmold trim. Subtract 1/2"(12.7) from M.O.(Masonry Opening) for Unit Sizes. Masonry openings above include Sill Nose, see Trim Options page for Sill Nose specifications. For other Trim Options refer to the Unit Sizing, Rough Opening & Masonry Openings page.

**ELEVATIONS  
30" WIDE X 42" HIGH PICTURE/AWNING  
COMBINATION**

MO BRICKMOLD	33 1/4"(845)	63 1/4"(1607)
MO FLAT CASING	36 5/16"(922)	66 5/16"(1684)
ROUGH OPENING	30 3/4"(781)	60 3/4"(1543)
FRAME SIZE	30"(762)	60"(1524)
DAYLIGHT OPENING	25 1/16"(637)	25 1/16"(637) [2]

63 11/32"(1609)  
64 7/8"(1648)  
60 3/4"(1543)  
60"(1524)  
36 15/32"(926) [1]  
12 15/32"(317) [1]



CWAP304218

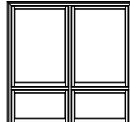

CWAP304218-2

65 11/32"(1660)  
66 7/8"(1699)  
62 3/4"(1594)  
62"(1575)  
36 15/32"(926) [1]  
14 15/32"(368) [1]



CWAP304220

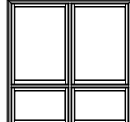

CWAP304220-2

69 11/32"(1761)  
70 7/8"(1800)  
66 3/4"(1695)  
66"(1676)  
36 15/32"(926) [1]  
18 15/32"(469) [1]

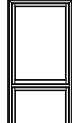

CWAP304224

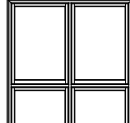

CWAP304224-2

73 11/32"(1863)  
74 7/8"(1902)  
70 3/4"(1797)  
70"(1778)  
36 15/32"(926) [1]  
22 15/32"(571) [1]

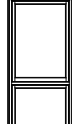

CWAP304228

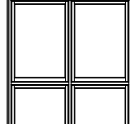

CWAP304228-2

75 11/32"(1914)  
76 7/8"(1953)  
72 3/4"(1848)  
72"(1828)  
36 15/32"(926) [1]  
24 15/32"(622) [1]



CWAP304230

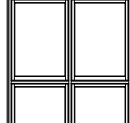

CWAP304230-2

**ELEVATION SYMBOL LEGEND:**  
M.O. = MASORNY OPENING  
VALUES IN ( ) ARE IN MILLIMETER CONVERSIONS

Note: Elevations shown include exterior sillnose and brickmold trim. Subtract 1/2"(12.7) from M.O.(Masonry Opening) for Unit Sizes. Masonry openings above include Sill Nose, see Trim Options page for Sill Nose specifications. For other Trim Options refer to the Unit Sizing, Rough Opening & Masonry Openings page.

**ELEVATIONS  
30" WIDE X 48" HIGH PICTURE/AWNING  
COMBINATION**

MO BRICKMOLD	33 1/4"(845)	63 1/4"(1607)
MO FLAT CASING	36 5/16"(922)	66 5/16"(1684)
ROUGH OPENING	30 3/4"(781)	60 3/4"(1543)
FRAME SIZE	30"(762)	60"(1524)
DAYLIGHT OPENING	25 1/16"(637)	25 1/16"(637) [2]

69 11/32"(1761)  
70 7/8"(1800)  
66 3/4"(1695)  
66"(1676)  
42 15/32"(1079) [1]  
12 15/32"(317) [1]

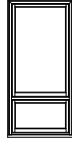

CWAP304818

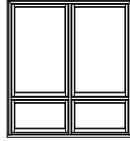

CWAP304818-2

71 11/32"(1812)  
72 7/8"(1851)  
68 3/4"(1746)  
68"(1727)  
42 15/32"(1079) [1]  
14 15/32"(369) [1]

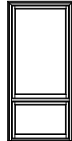

CWAP304820

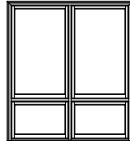

CWAP304820-2

75 11/32"(1914)  
76 7/8"(1953)  
72 3/4"(1848)  
72"(1829)  
42 15/32"(1079) [1]  
18 15/32"(469) [1]

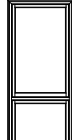

CWAP304824

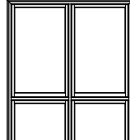

CWAP304824-2

79 11/32"(2015)  
80 7/8"(2054)  
76 3/4"(1949)  
76"(1930)  
42 15/32"(1079) [1]  
22 15/32"(571) [1]

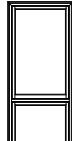

CWAP304828

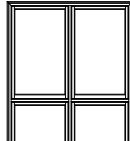

CWAP304828-2

81 11/32"(2066)  
82 7/8"(2105)  
78 3/4"(2000)  
78"(1981)  
42 15/32"(1079) [1]  
24 15/32"(622) [1]

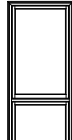

CWAP304830

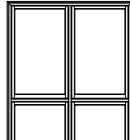

CWAP304830-2

**ELEVATION SYMBOL LEGEND:**  
M.O. = MASORNY OPENING  
VALUES IN ( ) ARE IN MILLIMETER CONVERSIONS

Note: Elevations shown include exterior sillnose and brickmold trim. Subtract 1/2"(12.7) from M.O.(Masonry Opening) for Unit Sizes. Masonry openings above include Sill Nose, see Trim Options page for Sill Nose specifications. For other Trim Options refer to the Unit Sizing, Rough Opening & Masonry Openings page.

**ELEVATIONS  
32" WIDE X 36" HIGH PICTURE/AWNING  
COMBINATION**

MO BRICKMOLD	35 1/4"(895)	67 1/4"(1708)
MO FLAT CASING	38 5/16"(973)	70 5/16"(1786)
ROUGH OPENING	32 3/4"(832)	64 3/4"(1645)
FRAME SIZE	32"(813)	64"(1626)
DAYLIGHT OPENING	27 1/16"(687)	25 1/16"(637) [2]

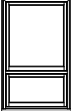
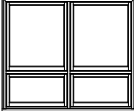
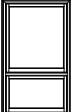
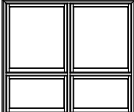
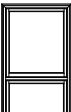
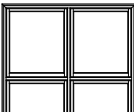
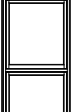
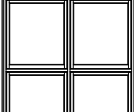
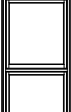
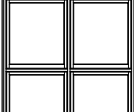
57 11/32"(1457) 58 7/8"(1495) 54 3/4"(1391) 54"(1372) 30 15/32"(774) [1] 12 15/32"(317) [1]		
CWAP323618	CWAP323618-2	
69 11/32"(1507) 60 7/8"(1546) 56 3/4"(1441) 56"(1422) 30 15/32"(774) [1] 14 15/32"(368) [1]		
CWAP323620	CWAP323620-2	
63 11/32"(1609) 64 7/8"(1648) 60 3/4"(1543) 60"(1543) 30 15/32"(774) [1] 18 15/32"(469) [1]		
CWAP323624	CWAP323624-2	
67 11/32"(1711) 68 7/8"(1749) 64 3/4"(1645) 64"(1626) 30 15/32"(774) [1] 22 15/32"(571) [1]		
CWAP323628	CWAP323628-2	
69 11/32"(1761) 70 7/8"(1800) 66 3/4"(1695) 66"(1676) 30 15/32"(774) [1] 24 15/32"(622) [1]		
CWAP323630	CWAP323630-2	

**ELEVATION SYMBOL LEGEND:**  
M.O. = MASORNY OPENING  
VALUES IN ( ) ARE IN MILLIMETER CONVERSIONS

Note: Elevations shown include exterior sillnose and brickmold trim. Subtract 1/2"(12.7) from M.O.(Masonry Opening) for Unit Sizes. Masonry openings above include Sill Nose, see Trim Options page for Sill Nose specifications. For other Trim Options refer to the Unit Sizing, Rough Opening & Masonry Openings page.

**ELEVATIONS  
32" WIDE X 40" HIGH PICTURE/AWNING  
COMBINATION**

MO BRICKMOLD	35 1/4"(895)	67 1/4"(1708)
MO FLAT CASING	38 5/16"(973)	70 5/16"(1786)
ROUGH OPENING	32 3/4"(832)	64 3/4"(1645)
FRAME SIZE	32"(813)	64"(1626)
DAYLIGHT OPENING	27 1/16"(687)	25 1/16"(637) [2]

61 11/32"(1558)  
62 7/8"(1597)  
58 3/4"(1492)  
56"(1473)  
34 15/32"(876) [1]  
12 15/32"(317) [1]

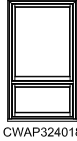

CWAP324018

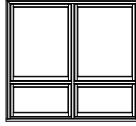

CWAP324018-2

63 11/32"(1609)  
64 7/8"(1648)  
60 3/4"(1543)  
60"(1524)  
34 15/32"(876) [1]  
14 15/32"(368) [1]

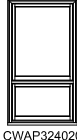

CWAP324020

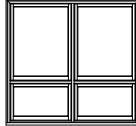

CWAP304020-2

67 11/32"(1711)  
68 7/8"(1749)  
64 3/4"(1645)  
64"(1626)  
34 15/32"(876) [1]  
18 15/32"(469) [1]

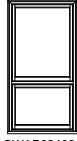

CWAP324024

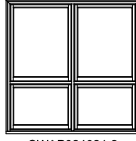

CWAP324024-2

71 11/32"(1812)  
72 7/8"(1851)  
68 3/4"(1746)  
68"(1727)  
34 15/32"(876) [1]  
22 15/32"(571) [1]

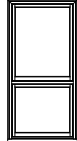

CWAP324028

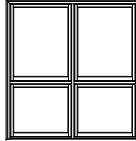

CWAP324028-2

73 11/32"(1863)  
74 7/8"(1902)  
70 3/4"(1797)  
70"(1778)  
34 15/32"(876) [1]  
24 15/32"(622) [1]

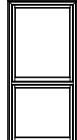

CWAP324030

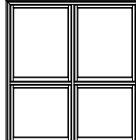

CWAP324030-2

**ELEVATION SYMBOL LEGEND:**  
M.O. = MASORNY OPENING  
VALUES IN ( ) ARE IN MILLIMETER CONVERSIONS

Note: Elevations shown include exterior sillnose and brickmold trim. Subtract 1/2"(12.7) from M.O.(Masonry Opening) for Unit Sizes. Masonry openings above include Sill Nose, see Trim Options page for Sill Nose specifications. For other Trim Options refer to the Unit Sizing, Rough Opening & Masonry Openings page.

**ELEVATIONS  
32" WIDE X 42" HIGH PICTURE/AWNING  
COMBINATION**

MO BRICKMOLD	35 1/4"(895)	67 1/4"(1708)
MO FLAT CASING	38 5/16"(973)	70 5/16"(1786)
ROUGH OPENING	32 3/4"(832)	64 3/4"(1645)
FRAME SIZE	32"(813)	64"(1626)
DAYLIGHT OPENING	27 1/16"(687)	25 1/16"(637) [2]

63 11/32"(1609)  
64 7/8"(1648)  
60 3/4"(1543)  
60"(1524)  
36 15/32"(926) [1]  
12 15/32"(317) [1]



CWAP324218



CWAP324218-2

65 11/32"(1660)  
66 7/8"(1699)  
62 3/4"(1594)  
62"(1575)  
36 15/32"(926) [1]  
14 15/32"(368) [1]



CWAP324220

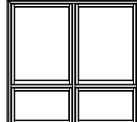

CWAP324220-2

69 11/32"(1761)  
70 7/8"(1800)  
66 3/4"(1695)  
66"(1676)  
36 15/32"(926) [1]  
18 15/32"(469) [1]

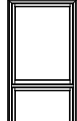

CWAP324224

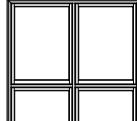

CWAP324224-2

73 11/32"(1863)  
74 7/8"(1902)  
70 3/4"(1797)  
70"(1778)  
36 15/32"(926) [1]  
22 15/32"(571) [1]

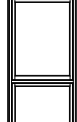

CWAP324228

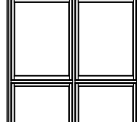

CWAP324228-2

75 11/32"(1914)  
76 7/8"(1953)  
72 3/4"(1848)  
72"(1828)  
36 15/32"(926) [1]  
24 15/32"(622) [1]

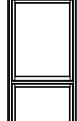

CWAP324230

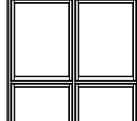

CWAP324230-2

**ELEVATION SYMBOL LEGEND:**  
M.O. = MASORNY OPENING  
VALUES IN ( ) ARE IN MILLIMETER CONVERSIONS

Note: Elevations shown include exterior sillnose and brickmold trim. Subtract 1/2"(12.7) from M.O.(Masonry Opening) for Unit Sizes. Masonry openings above include Sill Nose, see Trim Options page for Sill Nose specifications. For other Trim Options refer to the Unit Sizing, Rough Opening & Masonry Openings page.



**ELEVATIONS  
32" WIDE X 48" HIGH PICTURE/AWNING  
COMBINATION**

MO BRICKMOLD	35 1/4"(895)	67 1/4"(1708)
MO FLAT CASING	38 5/16"(973)	70 5/16"(1786)
ROUGH OPENING	32 3/4"(832)	64 3/4"(1645)
FRAME SIZE	32"(813)	64"(1626)
DAYLIGHT OPENING	27 1/16"(687)	25 1/16"(637) [2]

69 11/32"(1761)  
70 7/8"(1800)  
66 3/4"(1695)  
66"(1676)  
42 15/32"(1079) [1]  
12 15/32"(317) [1]

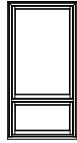

CWAP324818

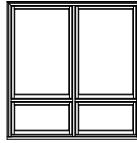

CWAP324818-2

71 11/32"(1812)  
72 7/8"(1851)  
68 3/4"(1746)  
68"(1727)  
42 15/32"(1079) [1]  
14 15/32"(368) [1]

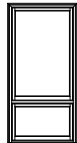

CWAP324820

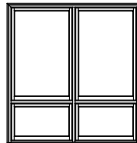

CWAP324820-2

75 11/32"(1914)  
76 7/8"(1953)  
72 3/4"(1848)  
72"(1829)  
42 15/32"(1079) [1]  
18 15/32"(469) [1]

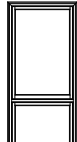

CWAP324824

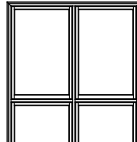

CWAP324824-2

79 11/32"(2015)  
80 7/8"(2054)  
76 3/4"(1949)  
76"(1930)  
42 15/32"(1079) [1]  
22 15/32"(571) [1]

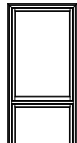

CWAP324828

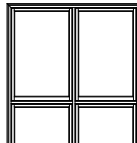

CWAP324828-2

81 11/32"(2066)  
82 7/8"(2105)  
78 3/4"(2000)  
78"(1981)  
42 15/32"(1079) [1]  
24 15/32"(622) [1]



CWAP324830

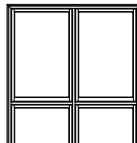







CWAP324830-2

**ELEVATION SYMBOL LEGEND:**  
M.O. = MASORNY OPENING  
VALUES IN ( ) ARE IN MILLIMETER CONVERSIONS

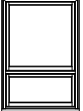
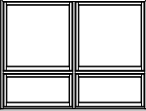
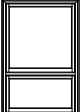
Note: Elevations shown include exterior sillnose and brickmold trim. Subtract 1/2"(12.7) from M.O.(Masonry Opening) for Unit Sizes. Masonry openings above include Sill Nose, see Trim Options page for Sill Nose specifications. For other Trim Options refer to the Unit Sizing, Rough Opening & Masonry Openings page.

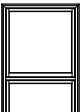
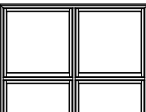
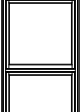
**ELEVATIONS  
36" WIDE X 36" HIGH PICTURE/AWNING  
COMBINATION**

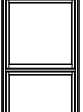
MO BRICKMOLD	39 1/4"(997)	75 1/4"(1911)
MO FLAT CASING	42 5/16"(1075)	78 5/16"(1989)
ROUGH OPENING	36 3/4"(933)	72 3/4"(1848)
FRAME SIZE	36"(914)	72"(1829)
DAYLIGHT OPENING	31 1/16"(789)	31 1/16"(789) [2]

57 11/32"(1457) 56 7/8"(1495) 54 3/4"(1391) 54"(1372) 30 15/32"(774) [1] 12 15/32"(317) [1]		
	CWAP363618	CWAP363618-2
59 11/32"(1507) 60 7/8"(1546) 56 3/4"(1441) 56"(1422) 30 15/32"(774) [1] 14 15/32"(368) [1]		
	CWAP363620	CWAP363620-2
63 11/32"(1609) 64 7/8"(1648) 60 3/4"(1543) 60"(1543) 30 15/32"(774) [1] 18 15/32"(469) [1]		
	CWAP363624	CWAP363624-2
67 11/32"(1711) 68 7/8"(1749) 64 3/4"(1645) 64"(1626) 30 15/32"(774) [1] 22 15/32"(571) [1]		
	CWAP363628	CWAP363628-2
69 11/32"(1761) 70 7/8"(1800) 66 3/4"(1695) 66"(1676) 30 15/32"(774) [1] 24 15/32"(622) [1]		
	CWAP363630	CWAP363630-2

**ELEVATION SYMBOL LEGEND:**  
M.O. = MASORNY OPENING  
VALUES IN ( ) ARE IN MILLIMETER CONVERSIONS

Note: Elevations shown include exterior sillnose and brickmold trim. Subtract 1/2"(12.7) from M.O.(Masonry Opening) for Unit Sizes. Masonry openings above include Sill Nose, see Trim Options page for Sill Nose specifications. For other Trim Options refer to the Unit Sizing, Rough Opening & Masonry Openings page.

**ELEVATIONS  
36" WIDE X 40" HIGH PICTURE/AWNING  
COMBINATION**

MO BRICKMOLD	39 1/4"(997)	75 1/4"(1911)
MO FLAT CASING	42 5/16"(1075)	78 5/16"(1989)
ROUGH OPENING	36 3/4"(933)	72 3/4"(1848)
FRAME SIZE	36"(914)	72"(1829)
DAYLIGHT OPENING	31 1/16"(789)	31 1/16"(789) [2]

61 11/32"(1558)  
62 7/8"(1597)  
58 3/4"(1492)  
56"(1473)  
34 15/32"(876) [1]  
12 15/32"(317) [1]

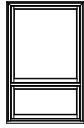

CWAP364018

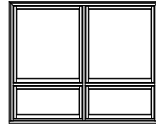

CWAP364018-2

63 11/32"(1609)  
64 7/8"(1648)  
60 3/4"(1543)  
60"(1524)  
34 15/32"(876) [1]  
14 15/32"(368) [1]

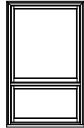

CWAP364020

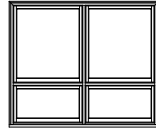

CWAP364020-2

67 11/32"(1711)  
68 7/8"(1749)  
64 3/4"(1645)  
64"(1626)  
34 15/32"(876) [1]  
18 15/32"(469) [1]

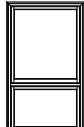

CWAP364024

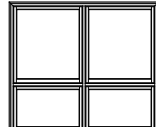

CWAP364024-2

71 11/32"(1812)  
72 7/8"(1851)  
68 3/4"(1746)  
68"(1727)  
34 15/32"(876) [1]  
22 15/32"(571) [1]

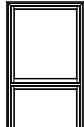

CWAP364028

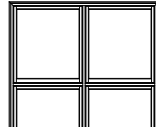

CWAP364028-2

73 11/32"(1863)  
74 7/8"(1902)  
70 3/4"(1797)  
70"(1778)  
34 15/32"(876) [1]  
24 15/32"(622) [1]

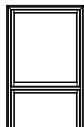

CWAP364030

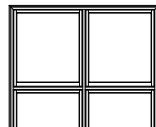

CWAP364030-2

**ELEVATION SYMBOL LEGEND:**  
M.O. = MASORNY OPENING  
VALUES IN ( ) ARE IN MILLIMETER CONVERSIONS

Note: Elevations shown include exterior sillnose and brickmold trim. Subtract 1/2"(12.7) from M.O.(Masonry Opening) for Unit Sizes. Masonry openings above include Sill Nose, see Trim Options page for Sill Nose specifications. For other Trim Options refer to the Unit Sizing, Rough Opening & Masonry Openings page.

**ELEVATIONS  
36" WIDE X 42" HIGH PICTURE/AWNING  
COMBINATION**

MO BRICKMOLD	39 1/4"(997)	75 1/4"(1911)
MO FLAT CASING	42 5/16"(1075)	78 5/16"(1989)
ROUGH OPENING	36 3/4"(933)	72 3/4"(1848)
FRAME SIZE	36"(914)	72"(1829)
DAYLIGHT OPENING	31 1/16"(789)	31 1/16"(789) [2]

63 11/32"(1609)  
64 7/8"(1648)  
60 3/4"(1543)  
60"(1524)  
36 15/32"(926) [1]  
12 15/32"(317) [1]

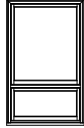

CWAP364218

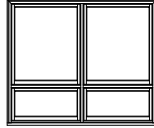

CWAP364218-2

65 11/32"(1660)  
66 7/8"(1699)  
62 3/4"(1594)  
62"(1575)  
36 15/32"(926) [1]  
14 15/32"(368) [1]

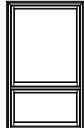

CWAP364220

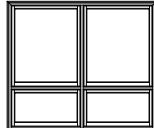

CWAP364220-2

69 11/32"(1761)  
70 7/8"(1800)  
66 3/4"(1695)  
66"(1676)  
36 15/32"(926) [1]  
18 15/32"(469) [1]

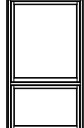

CWAP364224



CWAP364224-2

73 11/32"(1863)  
74 7/8"(1902)  
70 3/4"(1797)  
70"(1778)  
36 15/32"(926) [1]  
22 15/32"(571) [1]

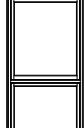

CWAP364228

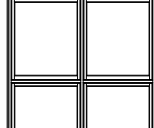

CWAP364228-2

75 11/32"(1914)  
76 7/8"(1953)  
72 3/4"(1848)  
72"(1829)  
36 15/32"(926) [1]  
24 15/32"(622) [1]

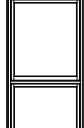

CWAP364230

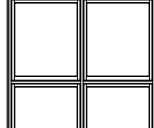

CWAP364230-2

**ELEVATION SYMBOL LEGEND:**  
M.O. = MASORNY OPENING  
VALUES IN ( ) ARE IN MILLIMETER CONVERSIONS

Note: Elevations shown include exterior sillnose and brickmold trim. Subtract 1/2"(12.7) from M.O.(Masonry Opening) for Unit Sizes. Masonry openings above include Sill Nose, see Trim Options page for Sill Nose specifications. For other Trim Options refer to the Unit Sizing, Rough Opening & Masonry Openings page.

**ELEVATIONS  
36" WIDE X 48" HIGH PICTURE/AWNING  
COMBINATION**

MO BRICKMOLD	39 1/4"(997)	75 1/4"(1911)
MO FLAT CASING	42 5/16"(1075)	78 5/16"(1989)
ROUGH OPENING	36 3/4"(933)	72 3/4"(1848)
FRAME SIZE	36"(914)	72"(1829)
DAYLIGHT OPENING	31 1/16"(789)	31 1/16"(789) [2]

69 11/32"(1761)  
70 7/8"(1800)  
66 3/4"(1695)  
66"(1676)  
42 15/32"(1079) [1]  
12 15/32"(317) [1]

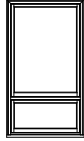

CWAP364818

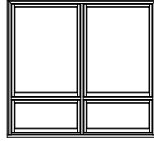

CWAP364818-2

71 11/32"(1812)  
72 7/8"(1851)  
68 3/4"(1746)  
68"(1727)  
42 15/32"(1079) [1]  
14 15/32"(369) [1]

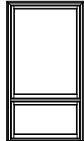

CWAP364820

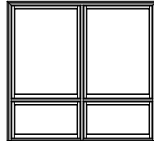

CWAP364820-2

75 11/32"(1914)  
76 7/8"(1953)  
72 3/4"(1848)  
72"(1829)  
42 15/32"(1079) [1]  
18 15/32"(469) [1]

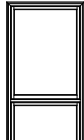

CWAP364824

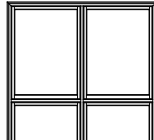

CWAP364824-2

79 11/32"(2015)  
80 7/8"(2054)  
76 3/4"(1949)  
76"(1930)  
42 15/32"(1079) [1]  
22 15/32"(571) [1]

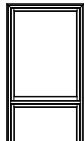

CWAP364828

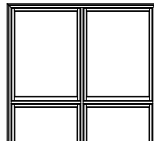

CWAP364828-2

81 11/32"(2066)  
82 7/8"(2105)  
78 3/4"(2000)  
78"(1981)  
42 15/32"(1079) [1]  
24 15/32"(622) [1]

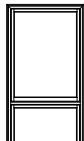

CWAP364830

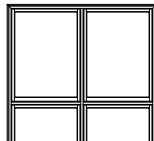

CWAP364830-2

**ELEVATION SYMBOL LEGEND:**  
M.O. = MASORNY OPENING  
VALUES IN ( ) ARE IN MILLIMETER CONVERSIONS

Note: Elevations shown include exterior sillnose and brickmold trim. Subtract 1/2"(12.7) from M.O.(Masonry Opening) for Unit Sizes. Masonry openings above include Sill Nose, see Trim Options page for Sill Nose specifications. For other Trim Options refer to the Unit Sizing, Rough Opening & Masonry Openings page.

ELEVATIONS  
42" WIDE X 36" HIGH PICTURE/AWNING  
COMBINATION

MO BRICKMOLD	45 1/4"(1149)	87 1/4"(2216)
MO FLAT CASING	48 5/16"(1227)	90 5/16"(2294)
ROUGH OPENING	42 3/4"(1086)	84 3/4"(2153)
FRAME SIZE	42"(1067)	84"(2134)
DAYLIGHT OPENING	37 1/16"(941)	37 1/16"(941) [2]

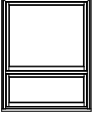
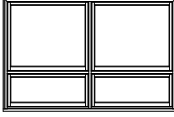
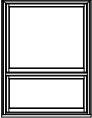
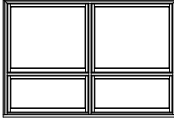
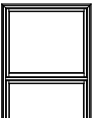
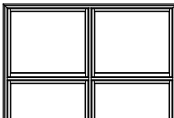
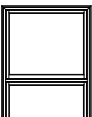
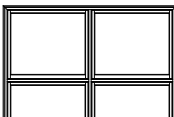
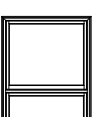
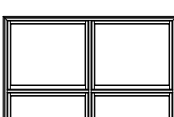
57 11/32"(1457) 58 7/8"(1495) 54 3/4"(1391) 54"(1372) 30 15/32"(774) [1] 12 15/32"(317) [1]		
	CWAP423618	CWAP423618-2
59 11/32"(1507) 60 7/8"(1546) 56 3/4"(1441) 56"(1422) 30 15/32"(774) [1] 14 15/32"(368) [1]		
	CWAP423620	CWAP423620-2
63 11/32"(1609) 64 7/8"(1648) 60 3/4"(1543) 60"(1543) 30 15/32"(774) [1] 18 15/32"(469) [1]		
	CWAP423624	CWAP423624-2
67 11/32"(1711) 68 7/8"(1749) 64 3/4"(1645) 64"(1626) 30 15/32"(774) [1] 22 15/32"(571) [1]		
	CWAP423628	CWAP423628-2
69 11/32"(1761) 70 7/8"(1800) 66 3/4"(1695) 66"(1676) 30 15/32"(774) [1] 24 15/32"(622) [1]		
	CWAP423630	CWAP423630-2

**ELEVATION SYMBOL LEGEND:**  
M.O. = MASORNY OPENING  
VALUES IN ( ) ARE IN MILLIMETER CONVERSIONS

Note: Elevations shown include exterior sillnose and brickmold trim. Subtract 1/2"(12.7) from M.O.(Masonry Opening) for Unit Sizes. Masonry openings above include Sill Nose, see Trim Options page for Sill Nose specifications. For other Trim Options refer to the Unit Sizing, Rough Opening & Masonry Openings page.

ELEVATIONS  
42" WIDE X 40" HIGH PICTURE/AWNING  
COMBINATION

MO BRICKMOLD	45 1/4"(1149)	87 1/4"(2216)
MO FLAT CASING	48 5/16"(1227)	90 5/16"(2294)
ROUGH OPENING	42 3/4"(1086)	84 3/4"(2153)
FRAME SIZE	42"(1067)	84"(2134)
DAYLIGHT OPENING	37 1/16"(941)	37 1/16"(941) [2]

61 11/32"(1558)  
62 7/8"(1597)  
58 3/4"(1492)  
56"(1473)  
34 15/32"(876) [1]  
12 15/32"(317) [1]

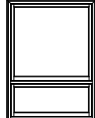

CWAP424018



CWAP424018-2

63 11/32"(1609)  
64 7/8"(1646)  
60 3/4"(1543)  
60"(1524)  
34 15/32"(876) [1]  
14 15/32"(368) [1]

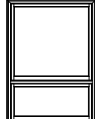

CWAP424020



CWAP424020-2

67 11/32"(1711)  
68 7/8"(1749)  
64 3/4"(1645)  
64"(1626)  
34 15/32"(876) [1]  
18 15/32"(469) [1]

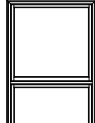

CWAP424024

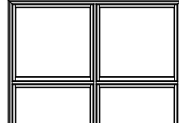

CWAP424024-2

71 11/32"(1812)  
72 7/8"(1851)  
68 3/4"(1746)  
68"(1727)  
34 15/32"(876) [1]  
22 15/32"(571) [1]

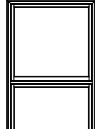

CWAP424028

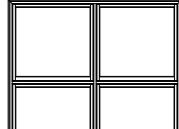

CWAP424028-2

73 11/32"(1863)  
74 7/8"(1902)  
70 3/4"(1797)  
70"(1778)  
34 15/32"(876) [1]  
24 15/32"(622) [1]

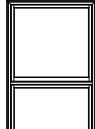

CWAP424030

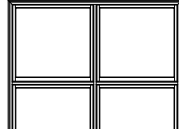

CWAP424030-2

**ELEVATION SYMBOL LEGEND:**  
M.O. = MASORNY OPENING  
VALUES IN ( ) ARE IN MILLIMETER CONVERSIONS

Note: Elevations shown include exterior sillnose and brickmold trim. Subtract 1/2"(12.7) from M.O.(Masonry Opening) for Unit Sizes. Masonry openings above include Sill Nose, see Trim Options page for Sill Nose specifications. For other Trim Options refer to the Unit Sizing, Rough Opening & Masonry Openings page.

ELEVATIONS  
42" WIDE X 42" HIGH PICTURE/AWNING  
COMBINATION

MO BRICKMOLD	45 1/4"(1149)	87 1/4"(2216)
MO FLAT CASING	48 5/16"(1227)	90 5/16"(2294)
ROUGH OPENING	42 3/4"(1086)	84 3/4"(2153)
FRAME SIZE	42"(1067)	84"(2134)
DAYLIGHT OPENING	37 1/16"(941)	37 1/16"(941) [2]

63 11/32"(1609)  
64 7/8"(1648)  
60 3/4"(1543)  
60"(1524)  
36 15/32"(926) [1]  
12 15/32"(317) [1]

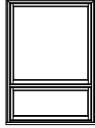

CWAP424218

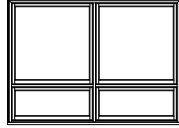

CWAP424218-2

65 11/32"(1660)  
66 7/8"(1699)  
62 3/4"(1594)  
62"(1575)  
36 15/32"(926) [1]  
14 15/32"(388) [1]

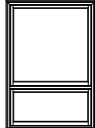

CWAP424220

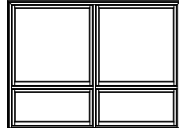

CWAP424220-2

69 11/32"(1761)  
70 7/8"(1800)  
66 3/4"(1695)  
66"(1676)  
36 15/32"(926) [1]  
18 15/32"(469) [1]

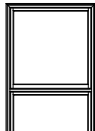

CWAP424224

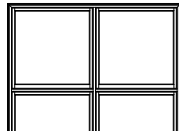

CWAP424224-2

73 11/32"(1863)  
74 7/8"(1902)  
70 3/4"(1797)  
70"(1778)  
36 15/32"(926) [1]  
22 15/32"(571) [1]

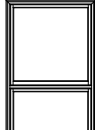

CWAP424228



CWAP424228-2

75 11/32"(1914)  
76 7/8"(1953)  
72 3/4"(1848)  
72"(1829)  
36 15/32"(926) [1]  
24 15/32"(622) [1]

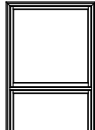

CWAP424230

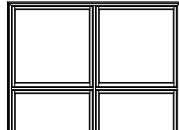

CWAP424230-2

**ELEVATION SYMBOL LEGEND:**  
M.O. = MASORNY OPENING  
VALUES IN ( ) ARE IN MILLIMETER CONVERSIONS

Note: Elevations shown include exterior sillnose and brickmold trim. Subtract 1/2"(12.7) from M.O.(Masonry Opening) for Unit Sizes. Masonry openings above include Sill Nose, see Trim Options page for Sill Nose specifications. For other Trim Options refer to the Unit Sizing, Rough Opening & Masonry Openings page.



ELEVATIONS  
42" WIDE X 48" HIGH PICTURE/AWNING  
COMBINATION

MO BRICKMOLD	45 1/4"(1149)	87 1/4"(2216)
MO FLAT CASING	48 5/16"(1227)	90 5/16"(2294)
ROUGH OPENING	42 3/4"(1086)	84 3/4"(2153)
FRAME SIZE	42"(1067)	84"(2134)
DAYLIGHT OPENING	37 1/16"(941)	37 1/16"(941) [2]

69 11/32"(1761)  
70 7/8"(1800)  
66 3/4"(1695)  
66"(1676)  
42 15/32"(1079) [1]  
12 15/32"(317) [1]

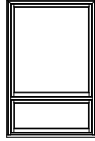

CWAP424818

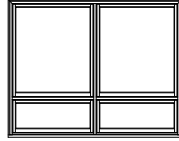

CWAP424818-2

71 11/32"(1812)  
72 7/8"(1851)  
68 3/4"(1746)  
68"(1727)  
42 15/32"(1079) [1]  
14 15/32"(369) [1]

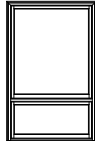

CWAP424820

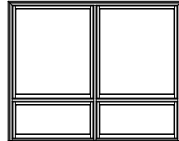

CWAP424820-2

75 11/32"(1914)  
76 7/8"(1953)  
72 3/4"(1848)  
72"(1829)  
42 15/32"(1079) [1]  
18 15/32"(469) [1]

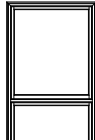

CWAP424824

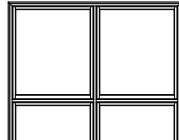

CWAP424824-2

79 11/32"(2015)  
80 7/8"(2054)  
76 3/4"(1949)  
76"(1930)  
42 15/32"(1079) [1]  
22 15/32"(571) [1]

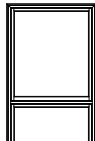

CWAP424828

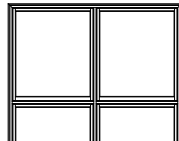

CWAP424828-2

81 11/32"(2066)  
82 7/8"(2105)  
78 3/4"(2000)  
78"(1981)  
42 15/32"(1079) [1]  
24 15/32"(622) [1]

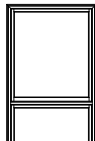

CWAP424830

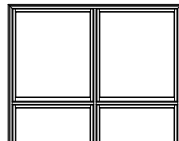

CWAP424830-2

**ELEVATION SYMBOL LEGEND:**  
M.O. = MASORNY OPENING  
VALUES IN ( ) ARE IN MILLIMETER CONVERSIONS

Note: Elevations shown include exterior sillnose and brickmold trim. Subtract 1/2"(12.7) from M.O.(Masonry Opening) for Unit Sizes. Masonry openings above include Sill Nose, see Trim Options page for Sill Nose specifications. For other Trim Options refer to the Unit Sizing, Rough Opening & Masonry Openings page.

**ELEVATIONS  
48" WIDE X 36" HIGH PICTURE/AWNING  
COMBINATION**

MO BRICKMOLD	51 1/4"(1302)	99 1/4"(2521)
MO FLAT CASING	54 5/16"(1380)	102 5/16"(2599)
ROUGH OPENING	48 3/4"(1238)	96 3/4"(2457)
FRAME SIZE	48"(1219)	96"(2438)
DAYLIGHT OPENING	43 1/16"(1094)	43 1/16"(1094) [2]

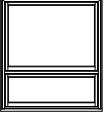
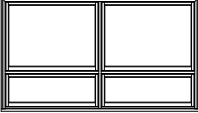
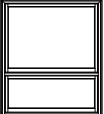
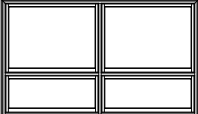
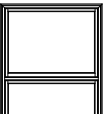
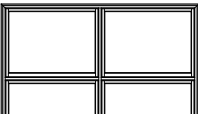
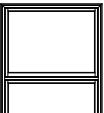
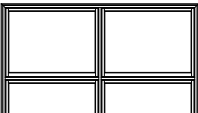
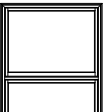
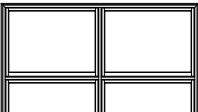
57 11/32"(1457) 56 7/8"(1495) 54 3/4"(1391) 54"(1372) 30 15/32"(774) [1] 12 15/32"(317) [1]		
	CWAP483618	CWAP483618-2
59 11/32"(1507) 60 7/8"(1546) 56 3/4"(1441) 56"(1422) 30 15/32"(774) [1] 14 15/32"(388) [1]		
	CWAP483620	CWAP483620-2
63 11/32"(1609) 64 7/8"(1648) 60 3/4"(1543) 60"(1543) 30 15/32"(774) [1] 18 15/32"(469) [1]		
	CWAP483624	CWAP483624-2
67 11/32"(1711) 68 7/8"(1749) 64 3/4"(1645) 64"(1626) 30 15/32"(774) [1] 22 15/32"(571) [1]		
	CWAP483628	CWAP483628-2
69 11/32"(1761) 70 7/8"(1800) 66 3/4"(1695) 66"(1676) 30 15/32"(774) [1] 24 15/32"(622) [1]		
	CWAP483630	CWAP483630-2

**ELEVATION SYMBOL LEGEND:**  
M.O. = MASORNY OPENING  
VALUES IN ( ) ARE IN MILLIMETER CONVERSIONS

Note: Elevations shown include exterior sillnose and brickmold trim. Subtract 1/2"(12.7) from M.O.(Masonry Opening) for Unit Sizes. Masonry openings above include Sill Nose, see Trim Options page for Sill Nose specifications. For other Trim Options refer to the Unit Sizing, Rough Opening & Masonry Openings page.

**ELEVATIONS  
48" WIDE X 40" HIGH PICTURE/AWNING  
COMBINATION**

MO BRICKMOLD	51 1/4"(1302)	99 1/4"(2521)
MO FLAT CASING	54 5/16"(1380)	102 5/16"(2599)
ROUGH OPENING	48 3/4"(1238)	96 3/4"(2457)
FRAME SIZE	48"(1219)	96"(2438)
DAYLIGHT OPENING	43 1/16"(1094)	43 1/16"(1094) [2]

61 11/32"(1558)  
62 7/8"(1597)  
58 3/4"(1492)  
56"(1473)  
34 15/32"(876) [1]  
12 15/32"(317) [1]

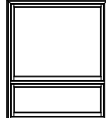

CWAP484018

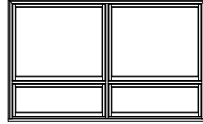

CWAP484018-2

63 11/32"(1609)  
64 7/8"(1648)  
60 3/4"(1543)  
60"(1524)  
34 15/32"(876) [1]  
14 15/32"(368) [1]

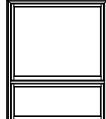

CWAP484020



CWAP484020-2

67 11/32"(1711)  
68 7/8"(1749)  
64 3/4"(1645)  
64"(1626)  
34 15/32"(876) [1]  
18 15/32"(469) [1]

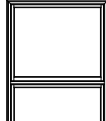

CWAP484024



CWAP484024-2

71 11/32"(1812)  
72 7/8"(1851)  
68 3/4"(1746)  
68"(1727)  
34 15/32"(876) [1]  
22 15/32"(571) [1]

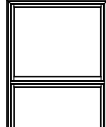

CWAP484028

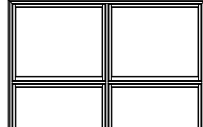

CWAP484028-2

73 11/32"(1863)  
74 7/8"(1902)  
70 3/4"(1797)  
70"(1778)  
34 15/32"(876) [1]  
24 15/32"(622) [1]

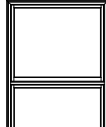

CWAP484030



CWAP484030-2

**ELEVATION SYMBOL LEGEND:**  
M.O. = MASORNY OPENING  
VALUES IN ( ) ARE IN MILLIMETER CONVERSIONS

Note: Elevations shown include exterior sillnose and brickmold trim. Subtract 1/2"(12.7) from M.O.(Masonry Opening) for Unit Sizes. Masonry openings above include Sill Nose, see Trim Options page for Sill Nose specifications. For other Trim Options refer to the Unit Sizing, Rough Opening & Masonry Openings page.

**ELEVATIONS  
48" WIDE X 42" HIGH PICTURE/AWNING  
COMBINATION**

MO BRICKMOLD	51 1/4"(1302)	99 1/4"(2521)
MO FLAT CASING	54 5/16"(1380)	102 5/16"(2599)
ROUGH OPENING	48 3/4"(1238)	96 3/4"(2457)
FRAME SIZE	48"(1219)	96"(2438)
DAYLIGHT OPENING	43 1/16"(1094)	43 1/16"(1094) [2]

63 11/32"(1609)  
64 7/8"(1648)  
60 3/4"(1543)  
60"(1524)  
36 15/32"(926) [1]  
12 15/32"(317) [1]

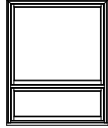

CWAP484218

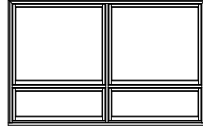

CWAP484218-2

65 11/32"(1660)  
66 7/8"(1699)  
62 3/4"(1594)  
62"(1575)  
36 15/32"(926) [1]  
14 15/32"(368) [1]

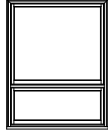

CWAP484220

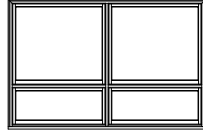

CWAP484220-2

69 11/32"(1761)  
70 7/8"(1800)  
66 3/4"(1695)  
66"(1676)  
36 15/32"(926) [1]  
18 15/32"(469) [1]

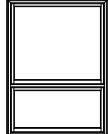

CWAP484224



CWAP484224-2

73 11/32"(1863)  
74 7/8"(1902)  
70 3/4"(1797)  
70"(1778)  
36 15/32"(926) [1]  
22 15/32"(571) [1]

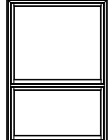

CWAP484228

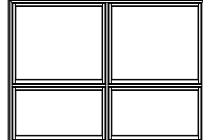

CWAP484228-2

75 11/32"(1914)  
76 7/8"(1953)  
72 3/4"(1848)  
72"(1828)  
36 15/32"(926) [1]  
24 15/32"(622) [1]

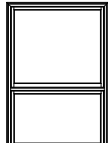

CWAP484230



CWAP484230-2

**ELEVATION SYMBOL LEGEND:**  
M.O. = MASORNY OPENING  
VALUES IN ( ) ARE IN MILLIMETER CONVERSIONS

Note: Elevations shown include exterior sillnose and brickmold trim. Subtract 1/2"(12.7) from M.O.(Masonry Opening) for Unit Sizes. Masonry openings above include Sill Nose, see Trim Options page for Sill Nose specifications. For other Trim Options refer to the Unit Sizing, Rough Opening & Masonry Openings page.

**ELEVATIONS  
48" WIDE X 48" HIGH PICTURE/AWNING  
COMBINATION**

MO BRICKMOLD	51 1/4"(1302)	99 1/4"(2521)
MO FLAT CASING	54 5/16"(1380)	102 5/16"(2599)
ROUGH OPENING	48 3/4"(1238)	96 3/4"(2457)
FRAME SIZE	48"(1219)	96"(2438)
DAYLIGHT OPENING	43 1/16"(1094)	43 1/16"(1094) [2]

69 11/32"(1761)  
70 7/8"(1800)  
66 3/4"(1695)  
66"(1676)  
42 15/32"(1079) [1]  
12 15/32"(317) [1]

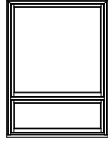

CWAP484818

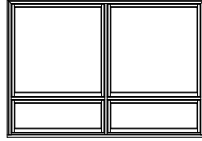

CWAP484818-2

71 11/32"(1812)  
72 7/8"(1851)  
68 3/4"(1746)  
68"(1727)  
42 15/32"(1079) [1]  
14 15/32"(369) [1]

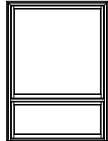

CWAP484820

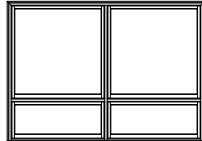

CWAP484820-2

75 11/32"(1914)  
76 7/8"(1953)  
72 3/4"(1848)  
72"(1829)  
42 15/32"(1079) [1]  
18 15/32"(469) [1]

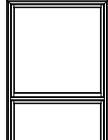

CWAP484824

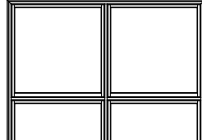

CWAP484824-2

79 11/32"(2015)  
80 7/8"(2054)  
76 3/4"(1949)  
76"(1930)  
42 15/32"(1079) [1]  
22 15/32"(571) [1]

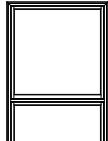

CWAP484828

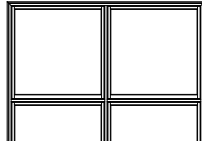

CWAP484828-2

81 11/32"(2066)  
82 7/8"(2105)  
78 3/4"(2000)  
78"(1981)  
42 15/32"(1079) [1]  
24 15/32"(622) [1]

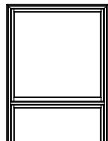

CWAP484830

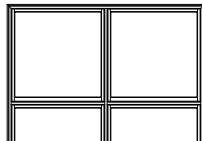

CWAP484830-2

**ELEVATION SYMBOL LEGEND:**  
M.O. = MASORNY OPENING  
VALUES IN ( ) ARE IN MILLIMETER CONVERSIONS

Note: Elevations shown include exterior sillnose and brickmold trim. Subtract 1/2"(12.7) from M.O.(Masonry Opening) for Unit Sizes. Masonry openings above include Sill Nose, see Trim Options page for Sill Nose specifications. For other Trim Options refer to the Unit Sizing, Rough Opening & Masonry Openings page.

**INTERIOR GLAZED GLAZING OPTIONS  
INSULATED 15/16" [24] GLASS**

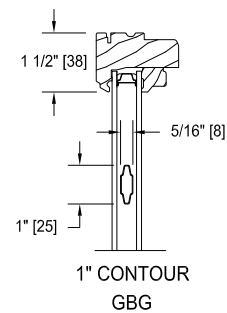
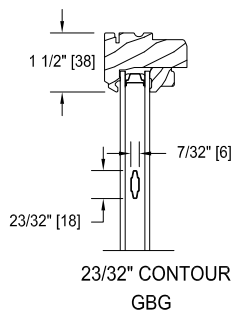
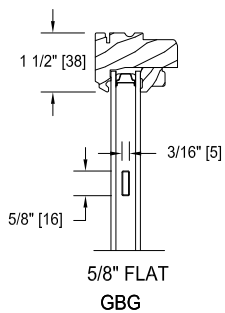
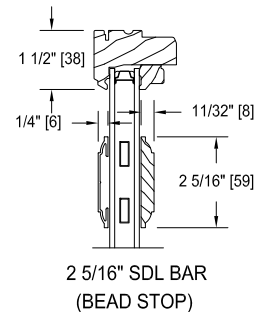
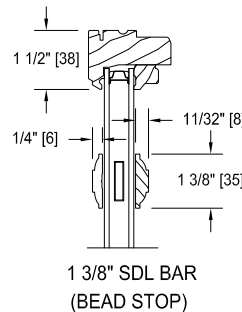
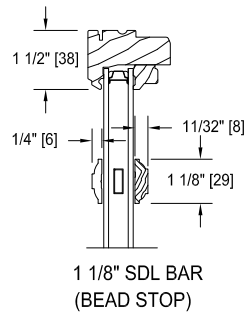
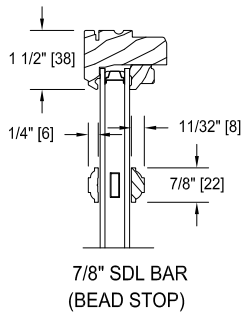
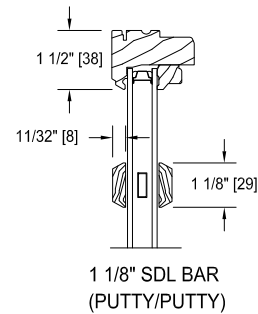
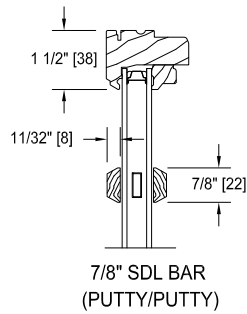
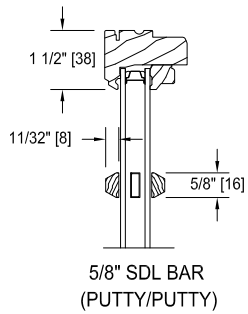
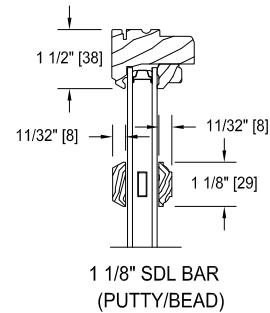
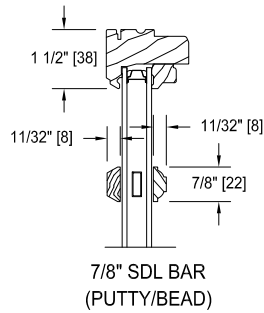
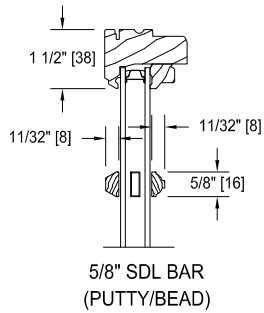
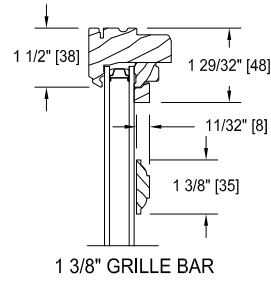
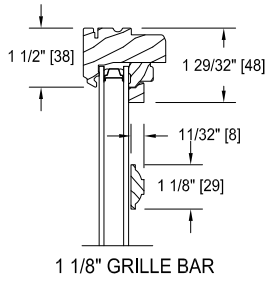
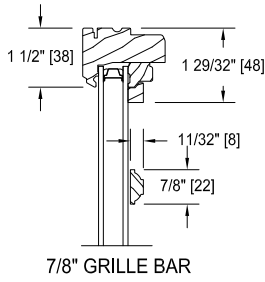

**INTERIOR GLAZED GLAZING OPTIONS**  
**INSULATED 1/8" [3] GLASS**

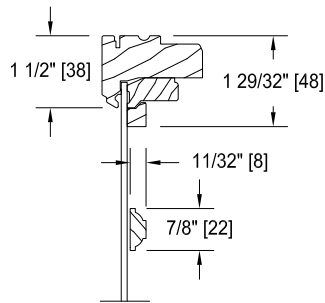

**7/8" GRILLE BAR**

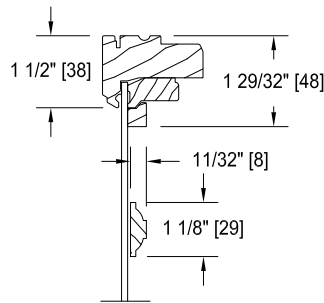

**1 1/8" GRILLE BAR**

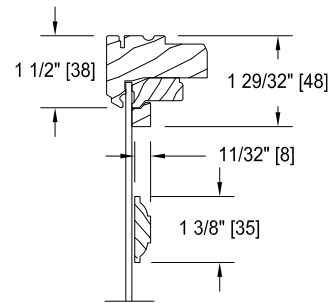

**1 3/8" GRILLE BAR**

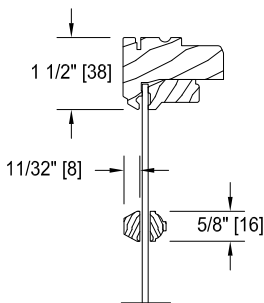

**5/8" SDL  
(PUTTY/BEAD)**

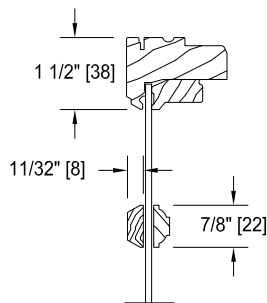

**7/8" SDL  
(PUTTY/BEAD)**

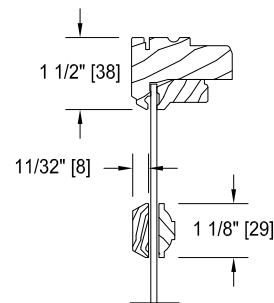

**1 1/8" SDL  
(PUTTY/BEAD)**

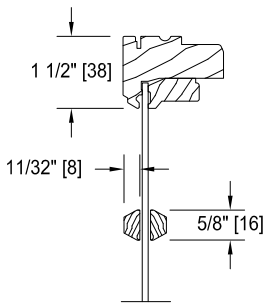

**5/8" SDL  
(PUTTY/PUTTY)**

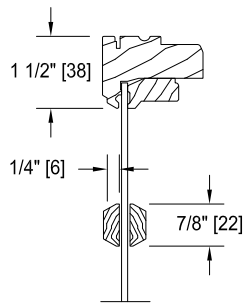

**7/8" SDL  
(PUTTY/PUTTY)**

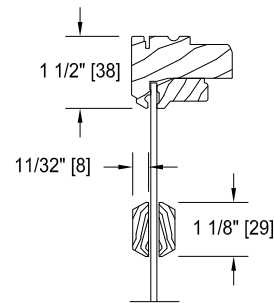

**1 1/8" SDL  
(PUTTY/PUTTY)**

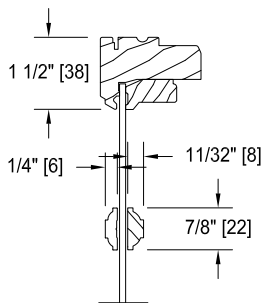

**7/8" SDL  
(BEAD STOP)**

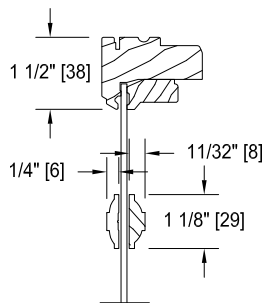

**1 1/8" SDL  
(BEAD STOP)**

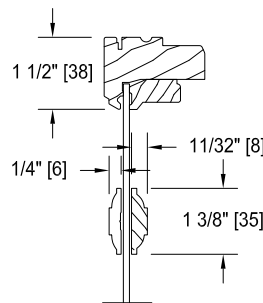

**1 3/8" SDL  
(BEAD STOP)**

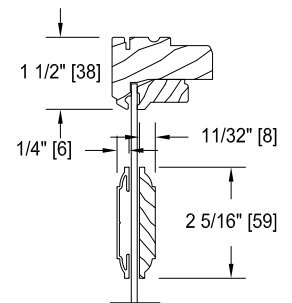

**2 5/16" SDL BAR  
(BEAD STOP)**

INTERIOR GLAZED GLAZING OPTIONS  
INSULATED 3/8" [10] GLASS

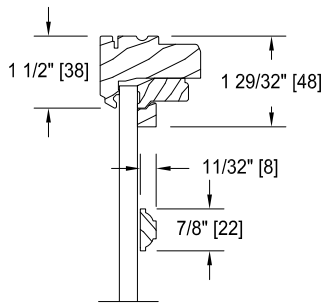

7/8" GRILLE BAR

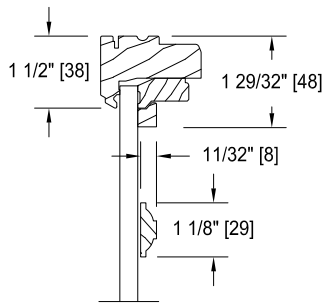

1 1/8" GRILLE BAR

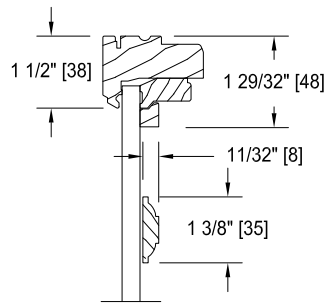

1 3/8" GRILLE BAR

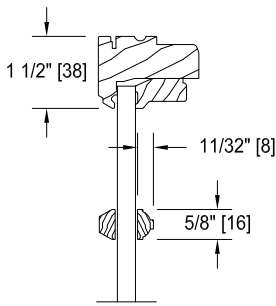

5/8" SDL  
(PUTTY/BEAD)

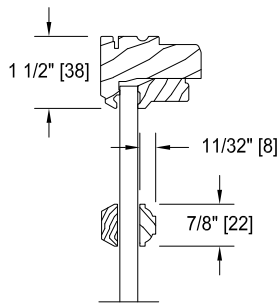

7/8" SDL  
(PUTTY/BEAD)

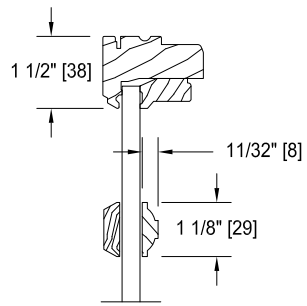

1 1/8" SDL  
(PUTTY/BEAD)

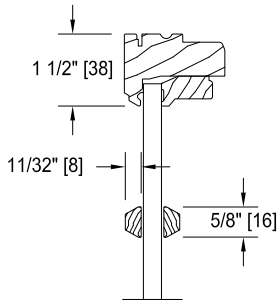

5/8" SDL  
(PUTTY/PUTTY)

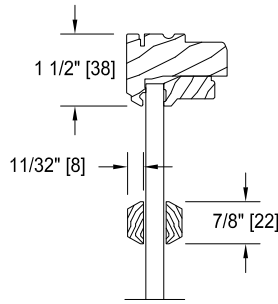

7/8" SDL  
(PUTTY/PUTTY)

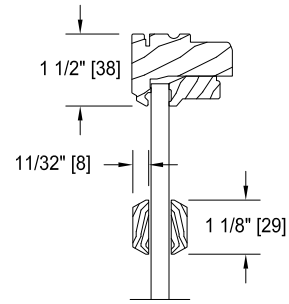

1 1/8" SDL  
(PUTTY/PUTTY)

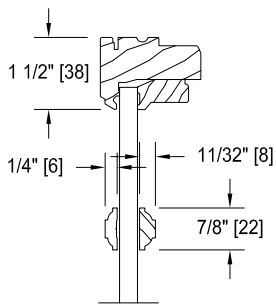

7/8" SDL  
(BEAD STOP)

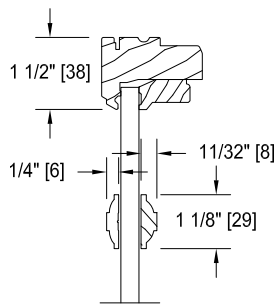

1 1/8" SDL  
(BEAD STOP)

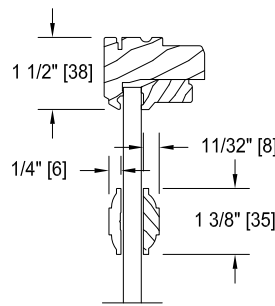

1 3/8" SDL  
(BEAD STOP)

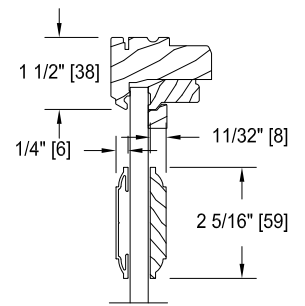

2 5/16" SDL BAR  
(BEAD STOP)



**SASH GLAZING OPTIONS INSULATED  
EXTERIOR GLAZED**

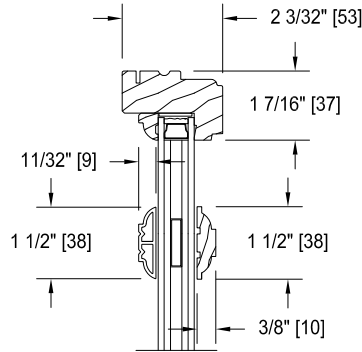

1 1/2" PDL  
CLAD EXTERIOR BAR  
3/4" [19] Glass

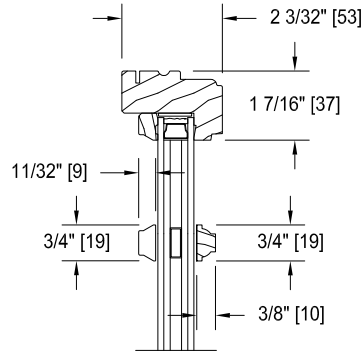

3/4" PDL  
CLAD EXTERIOR BAR  
3/4" [19] Glass

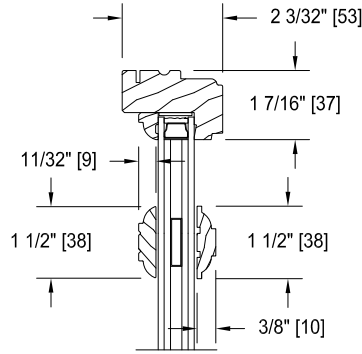

1 1/2" PDL  
WOOD EXTERIOR BAR  
3/4" [19] Glass

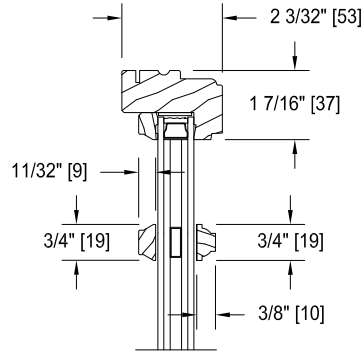

3/4" PDL  
WOOD EXTERIOR BAR  
3/4" [19] Glass

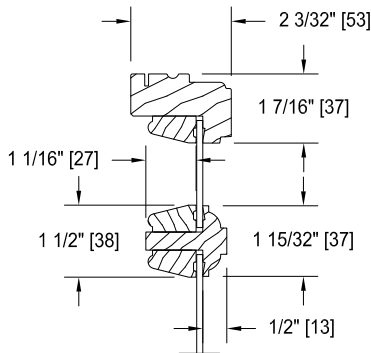

1 1/2" TDL  
TRUE DIVIDED LITE  
1/8" [3] Glass

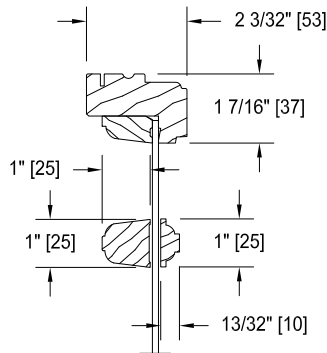

1" PNB  
1/8" [3] Glass

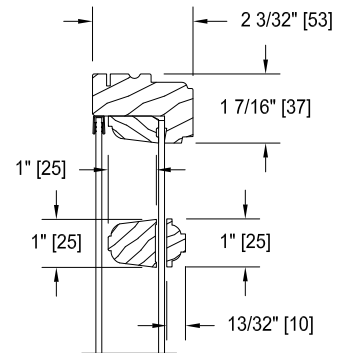

1" PNB  
WITH ENERGY PANEL

TRIM OPTIONS  
WOOD EXTERIOR TRIM

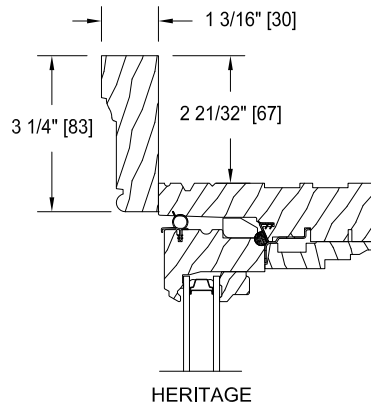
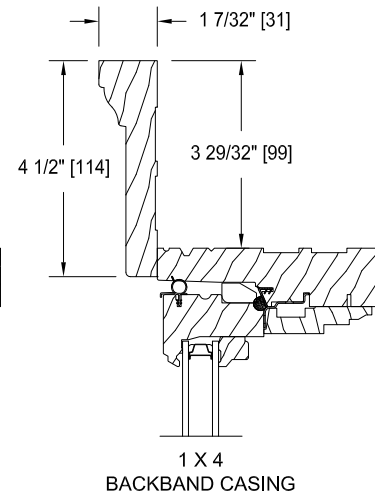
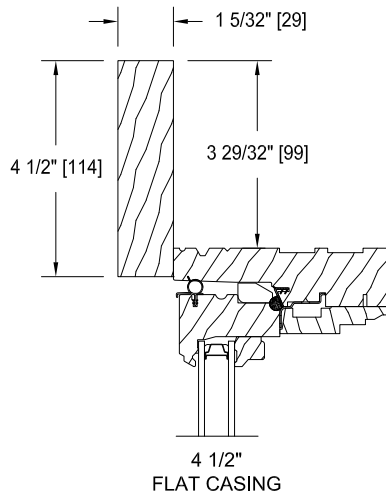
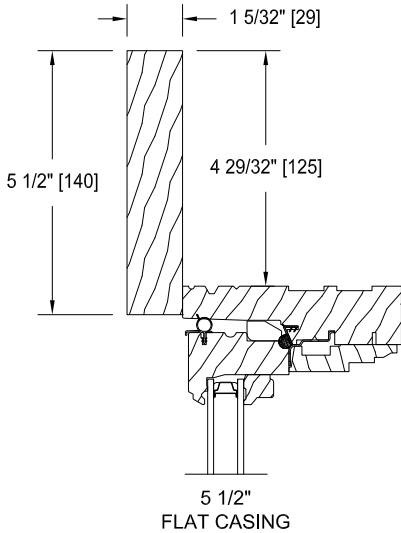
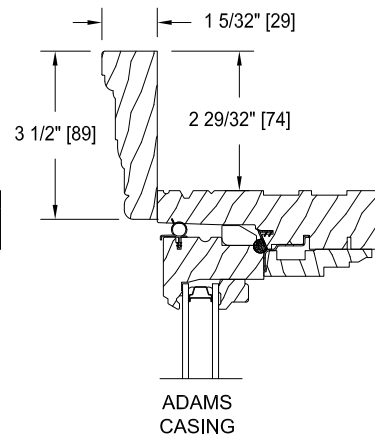
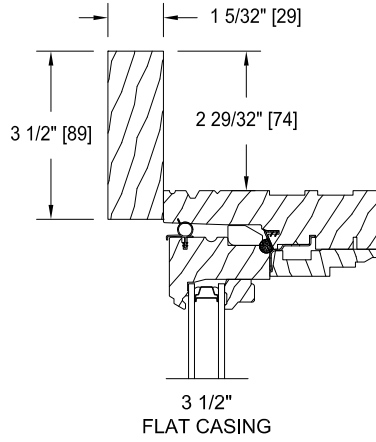
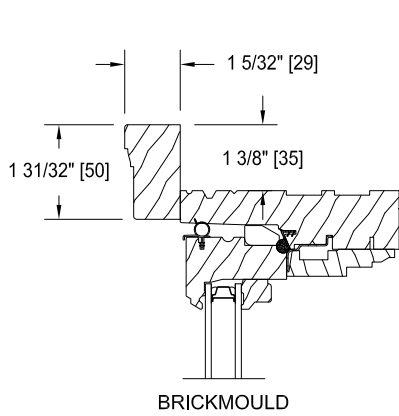

**SILL OPTIONS  
WOOD SUBSILL OPTIONS**

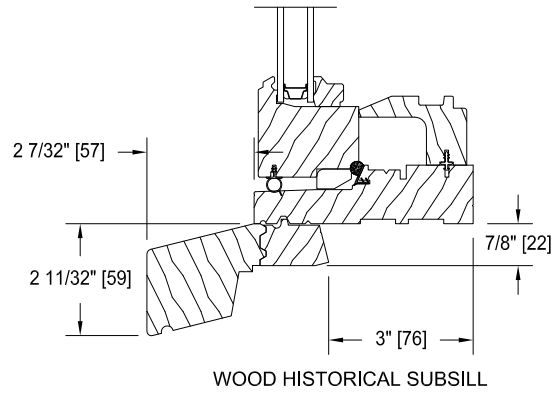
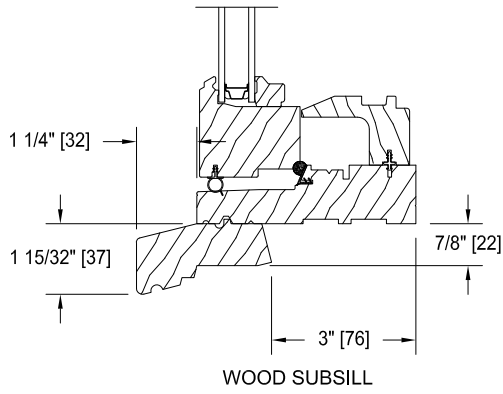

JAMB EXTENDER & STUCCO OPTIONS

JAMB EXTENDER OPTIONS

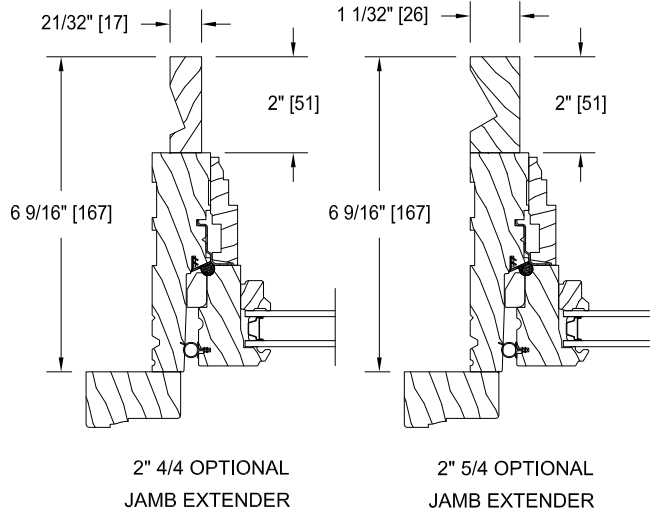

MAXIMUM JAMB WIDTHS

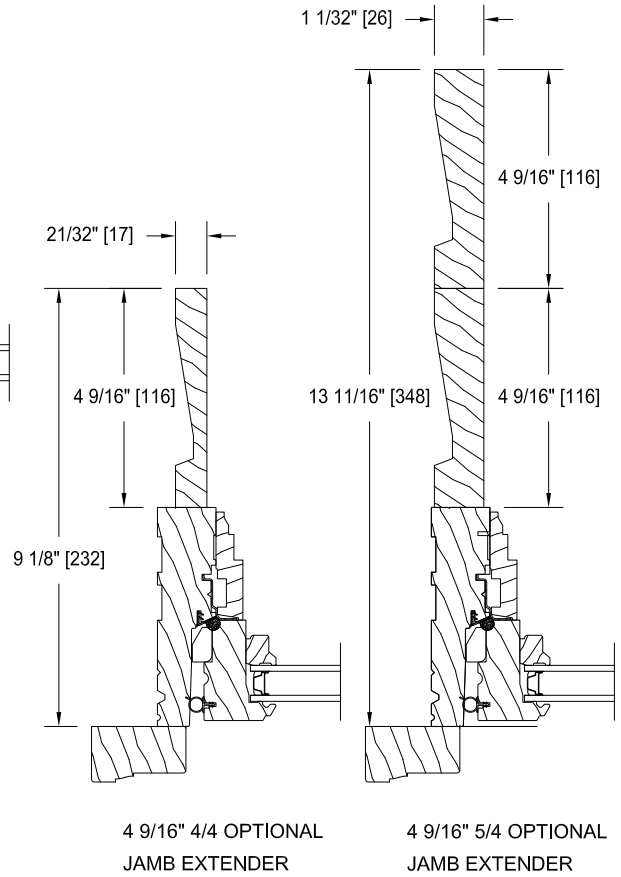

RETURN KERF OPTION

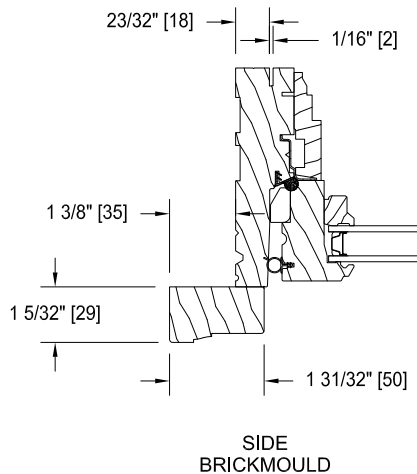

STUCCO TRIM OPTION

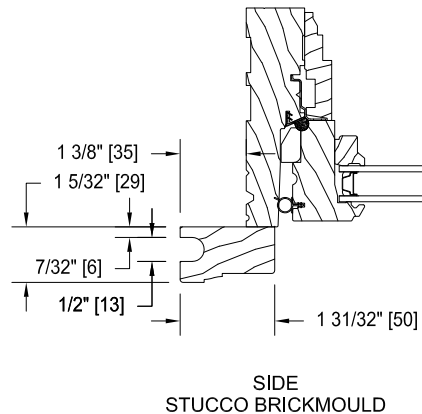

**STANDARD MULLION DETAILS**

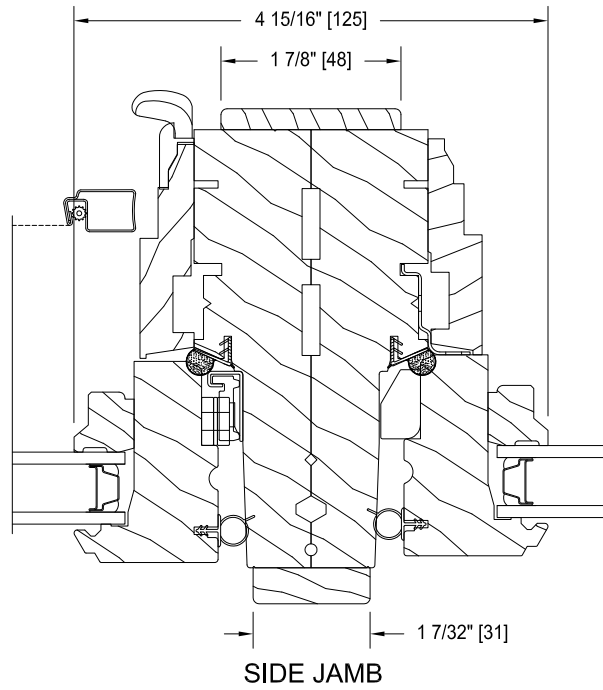
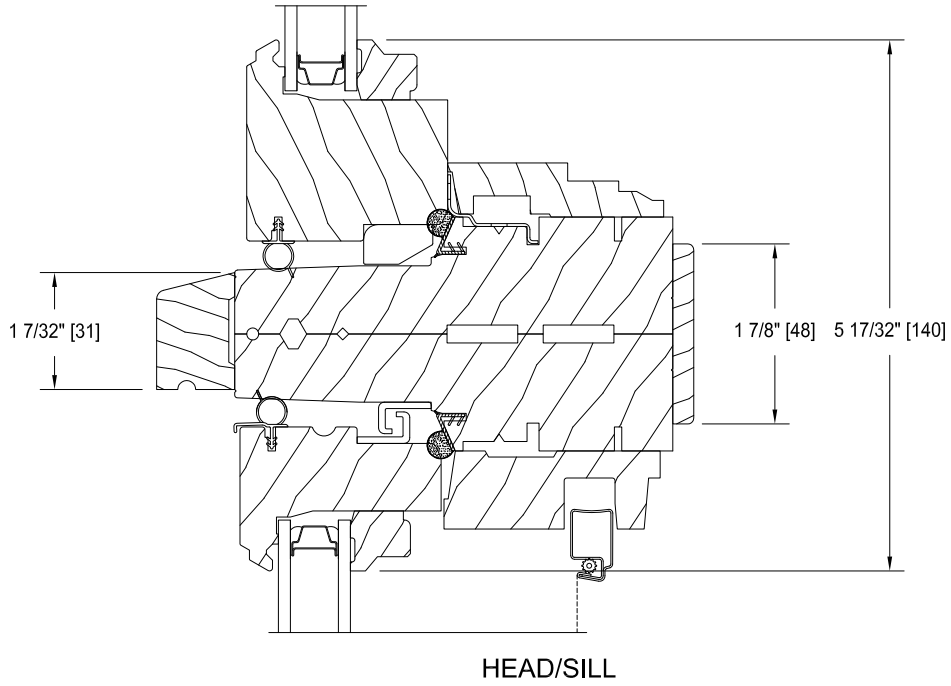

LITE CUT INFORMATION

Wood awning windows are available with removable grilles in 7/8", 1-1/8" and 1-3/8" widths, Airspace ( between the panes) grilles, and Simulated Divided Lites. Standard lite cuts are rectangular, and conform to the layouts noted in the charts on the next page. To use the chart, refer to the appropriate table by the type of window and type of bars or grilles the section drawings illustrate. Then simply cross reference the frame Height and Width to determine the standard lite cut.

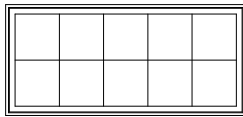

RECTANGULAR

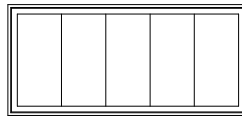

VERTICAL

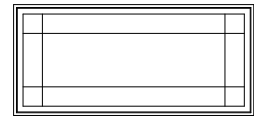

PRAIRIE

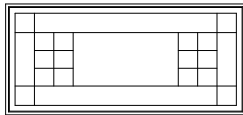

UNEVEN

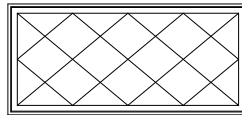

DIAMOND

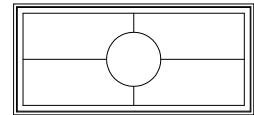

RADIUS

LITE CUT OPTIONS

Special lite cut patterns can include a wide variety of straight line and radius patterns. The illustrations shown here represent just a few of the possibilities. Rectangular, horizontal, vertical and Prairie lite patterns are available in all standard size wood casement windows. Uneven, diamond, radius and Gothic lite cuts are available, subject to approval. Approvals are based on the ability to fulfill the design requirement while maintaining the construction integrity of the finished product.

BAR ALIGNMENT

Alignment of divided lite muntin bars from one window to the next is often required by fine architectural design. Wood grilles, Airspace grilles, and Simulated Divided Lites may be specified with muntin bars aligned.

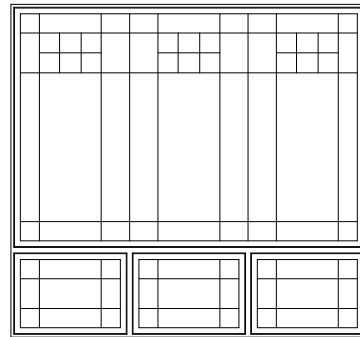

**VENT PROJECTION**

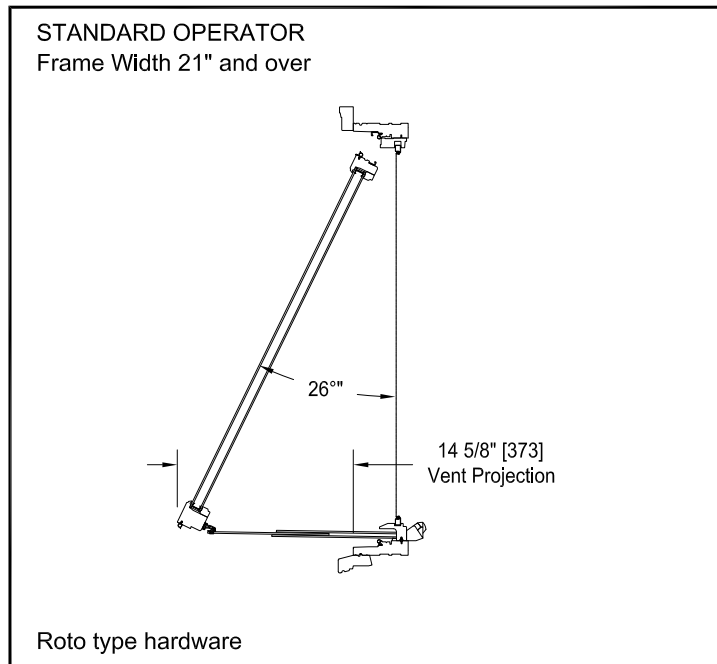
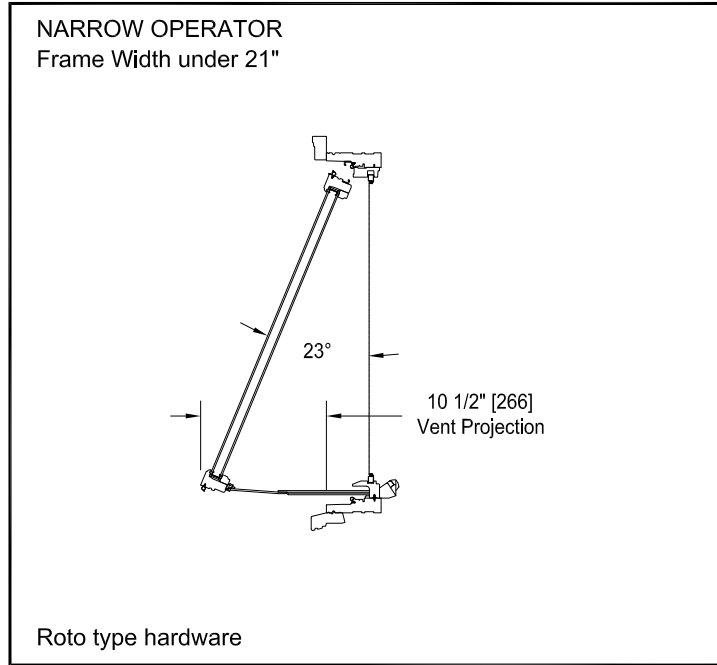

**AWNING VENT PROJECTION**

The drawings above reflect full operation. Dimensions and angles above are approximate and will vary due to frame height.

**UNIT SIZING, ROUGH OPENINGS &  
MASONRY OPENINGS**

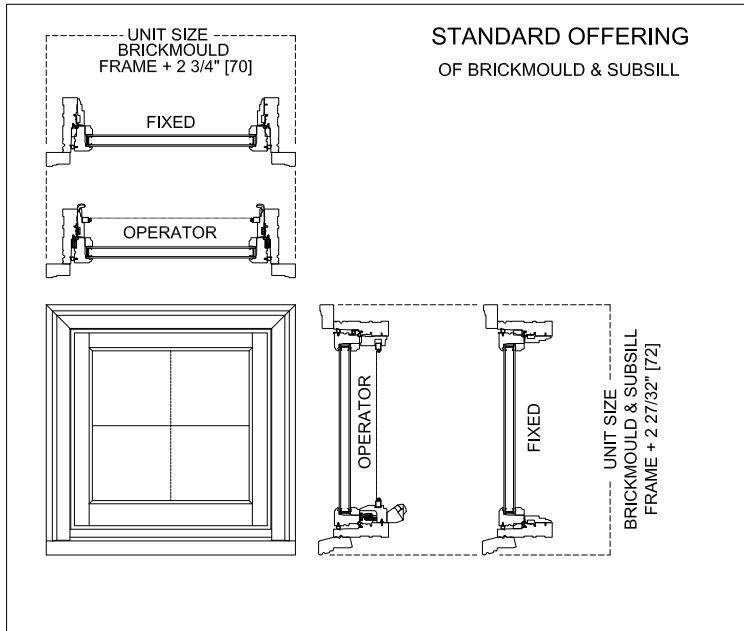

**GENERAL NOTES:**

UNITS WITH NO TRIM OR SUBSILL:  
UNIT SIZE = FRAME SIZE

UNIT SIZE IS ALWAYS THE  
EXTREME SIZE OF THE WINDOW  
WITH OR WITHOUT TRIM

**MASONRY OPENING:**

MASONRY OPENING IS ALWAYS 1/2" OVER  
THE UNIT SIZE OF THE WINDOW

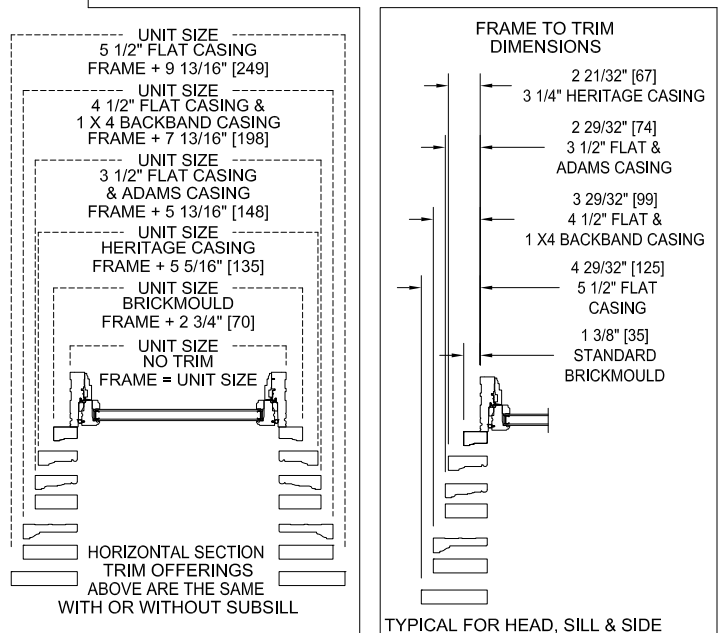
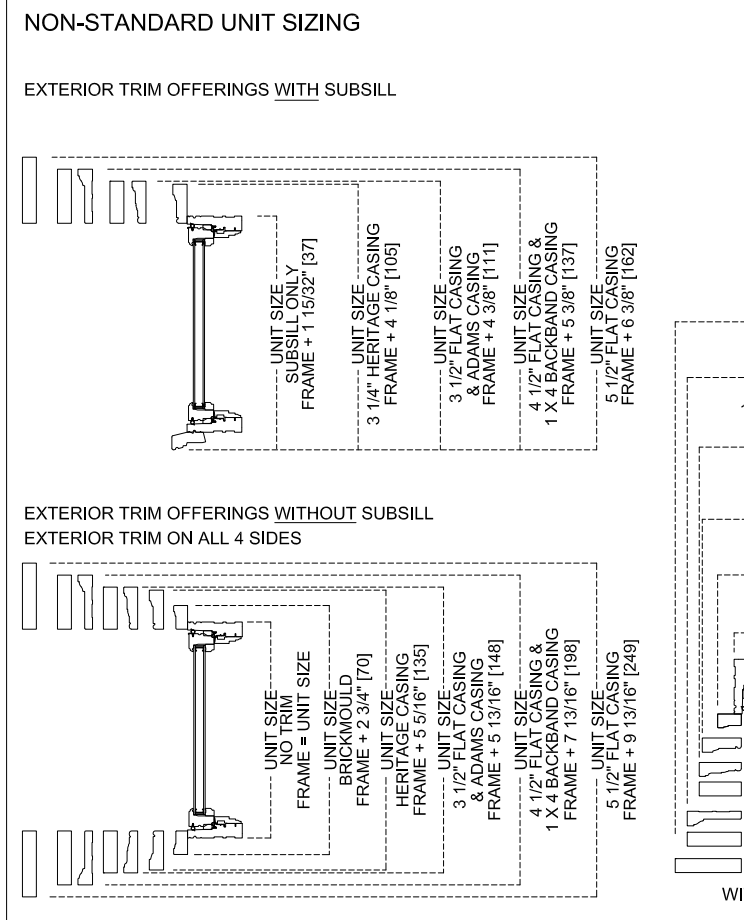
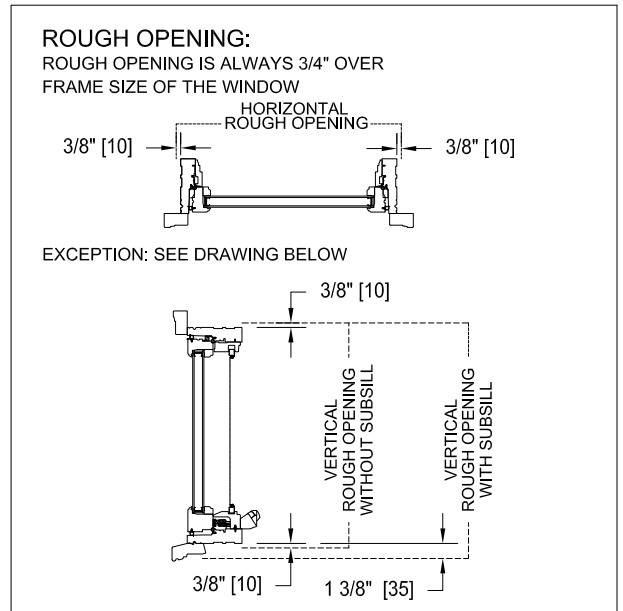



**OPERATING UNIT  
VERTICAL SECTION**

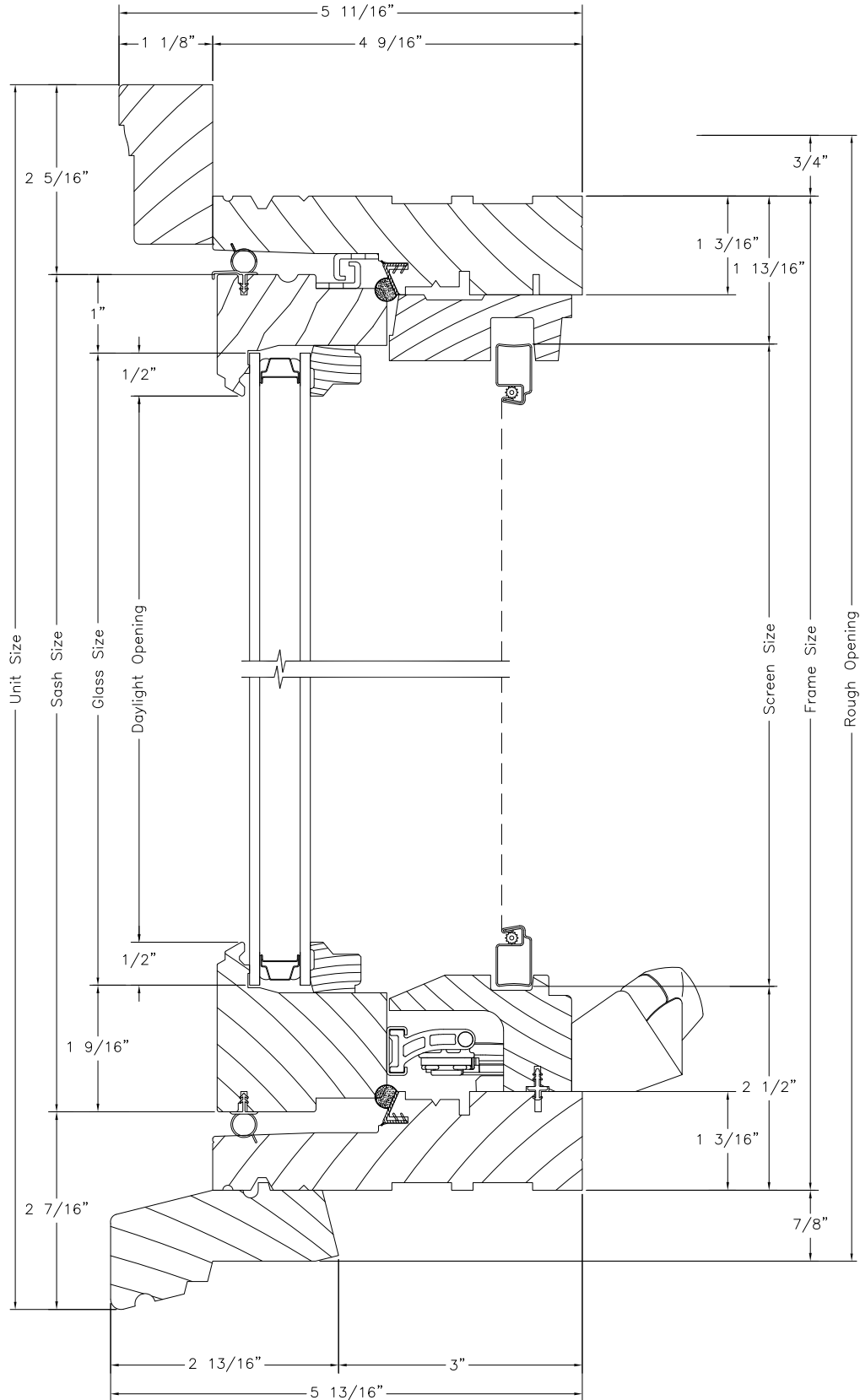

**OPERATING UNIT**  
**HORIZONTAL SECTION**

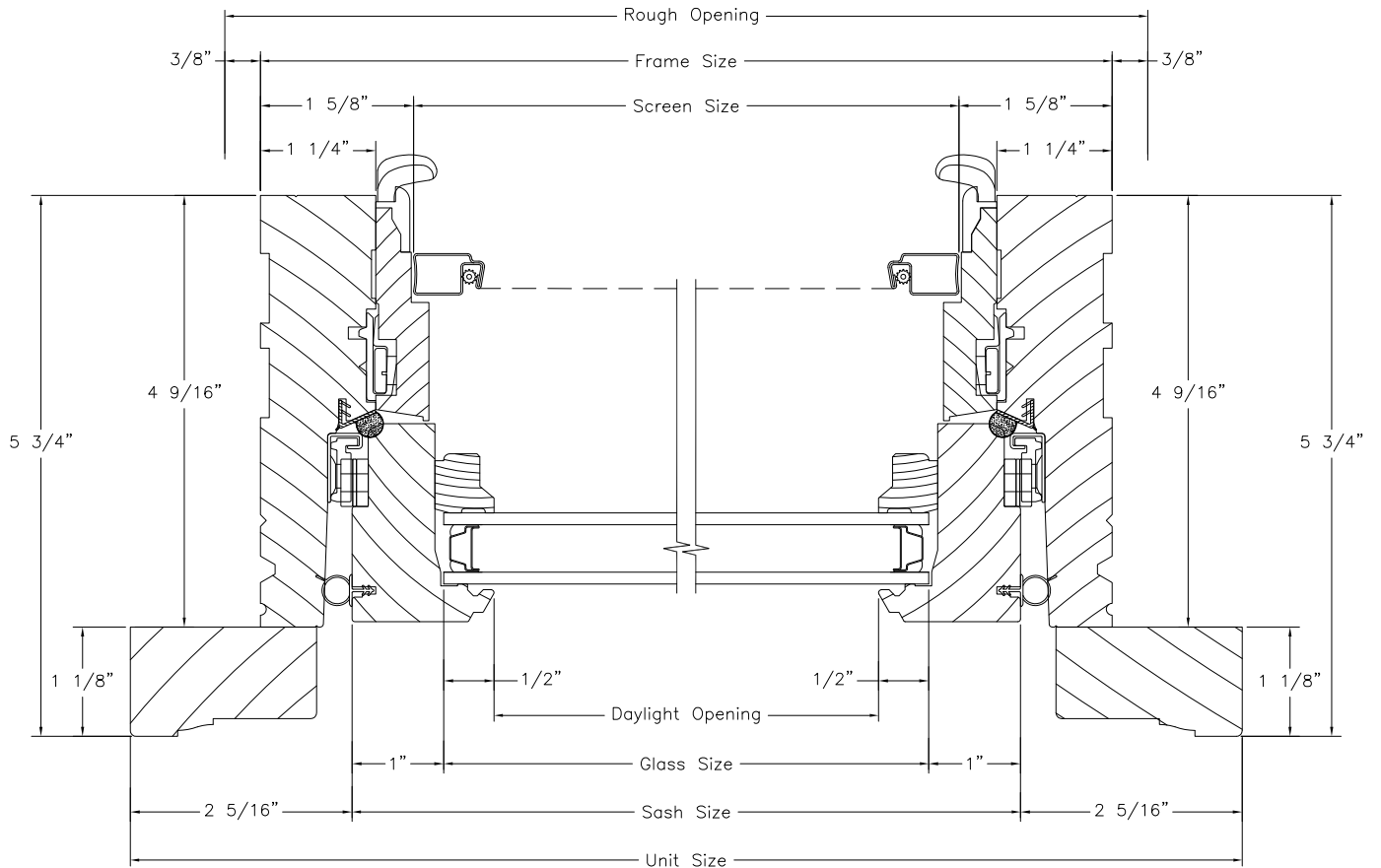

**PICTURE UNIT  
VERTICAL SECTION**

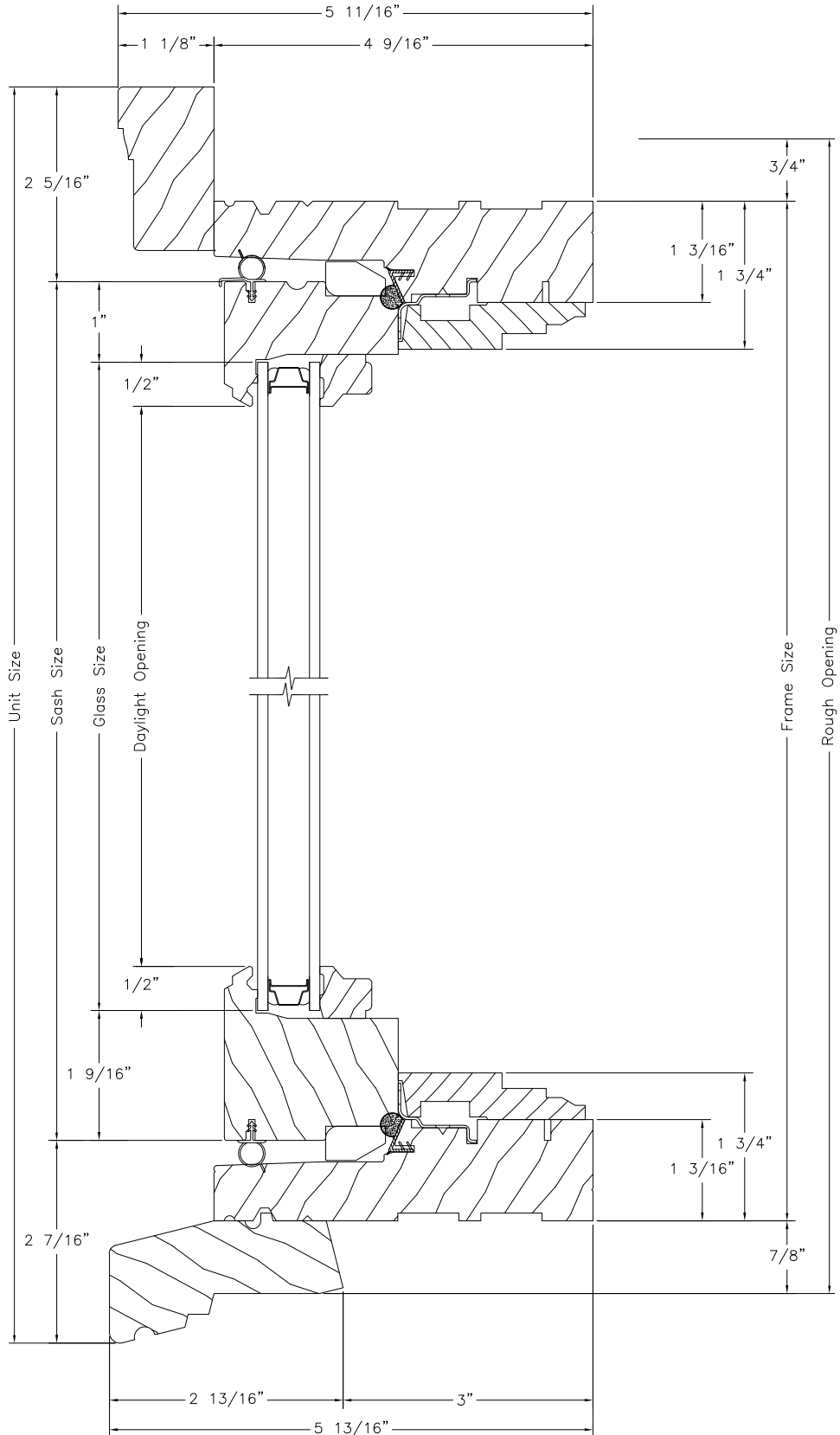

**PICTURE UNIT**  
**HORIZONTAL SECTION**

