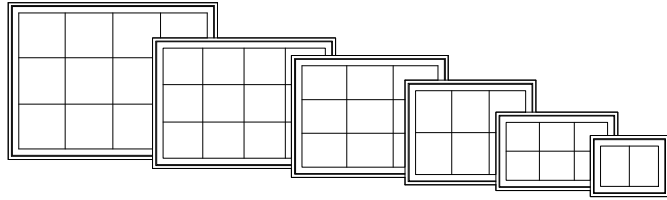
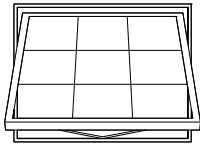

TABLE OF CONTENTS

General Information	5-2
Elevation Notes	5-3
Elevations/Sizes:	
Operating Units	5-4
Stationary Units	5-10
2-Wide 1-High.	5-16
1-Wide 2-High.	5-18
2-Wide 2-High.	5-20
30" Width Combinations..	5-22
32" Width Combinations..	5-26
36" Width Combinations..	5-30
42" Width Combinations..	5-34
48" Width Combinations..	5-38
Glazing Options	5-42
Unit Sizing, Rough Opening & Masonry Openings	5-45
Trim Options	5-46
Jamb Extender Options	5-47
Jamb Width Options	5-48
Mullion Details	5-49
Grille & SDL Patterns	5-50
Vent Projections	5-51
Section Details: 6" Scale.	5-52

GENERAL INFORMATION



DIMENSIONAL WINDOWS

Clad awning windows may be specified as "dimensional", by adjusting the desired rough opening width or height in 1/16" increments from standard.

Clad awning windows are available as operating, or stationary (non - venting). Operating mechanism includes corrosion resistant steel hinges and roto-type operators for venting units. Sash locks are concealed unison type with an exposed locking lever and escutcheon plate. There are several interior hardware finish options. Refer to the Specifications for finish options.

MULTIPLE ASSEMBLIES

Clad awning windows may be mullied above, below, or beside other clad awning windows, or other clad window products. Factory assembled mulls are limited in height (100"), width (150"), and a total area (75 square feet).

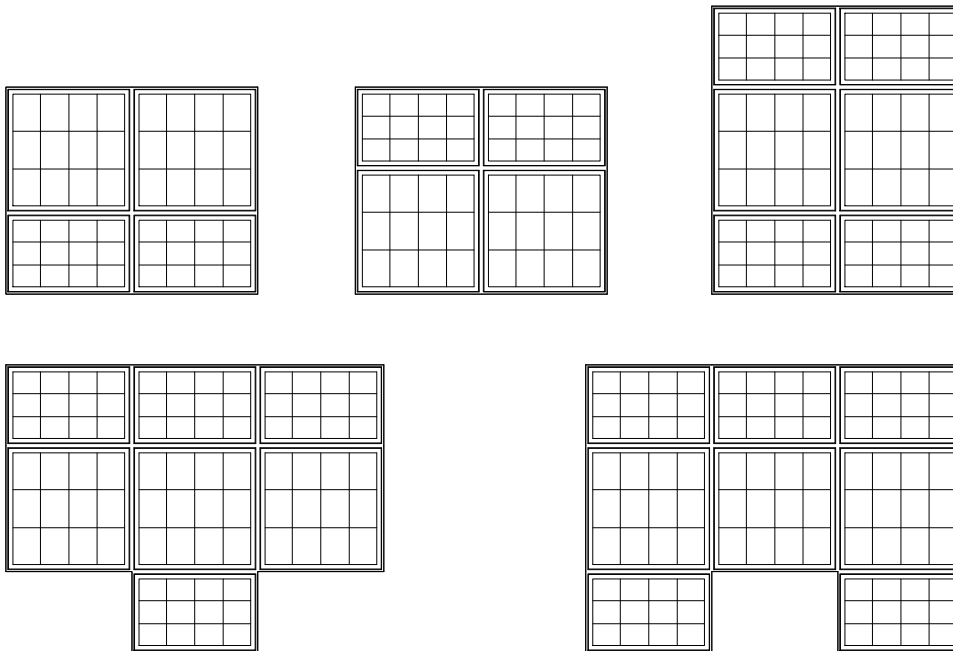

ELEVATION NOTES

ELEVATION DRAWINGS UTILIZE A LIMITED NUMBER OF PROJECTED LINES TO PRODUCE A RUDIMENTARY DRAWING INTENDED TO BE USED IN A SMALL GRAPHICAL SCALE. ELEVATIONS ARE VIEWED PERPENDICULAR FROM THE EXTERIOR OF THE STRUCTURE. IF MORE DIMENSIONS ARE NEEDED, USE THE SECTION DRAWINGS FOR MORE COMPLETE DEPICTIONS.

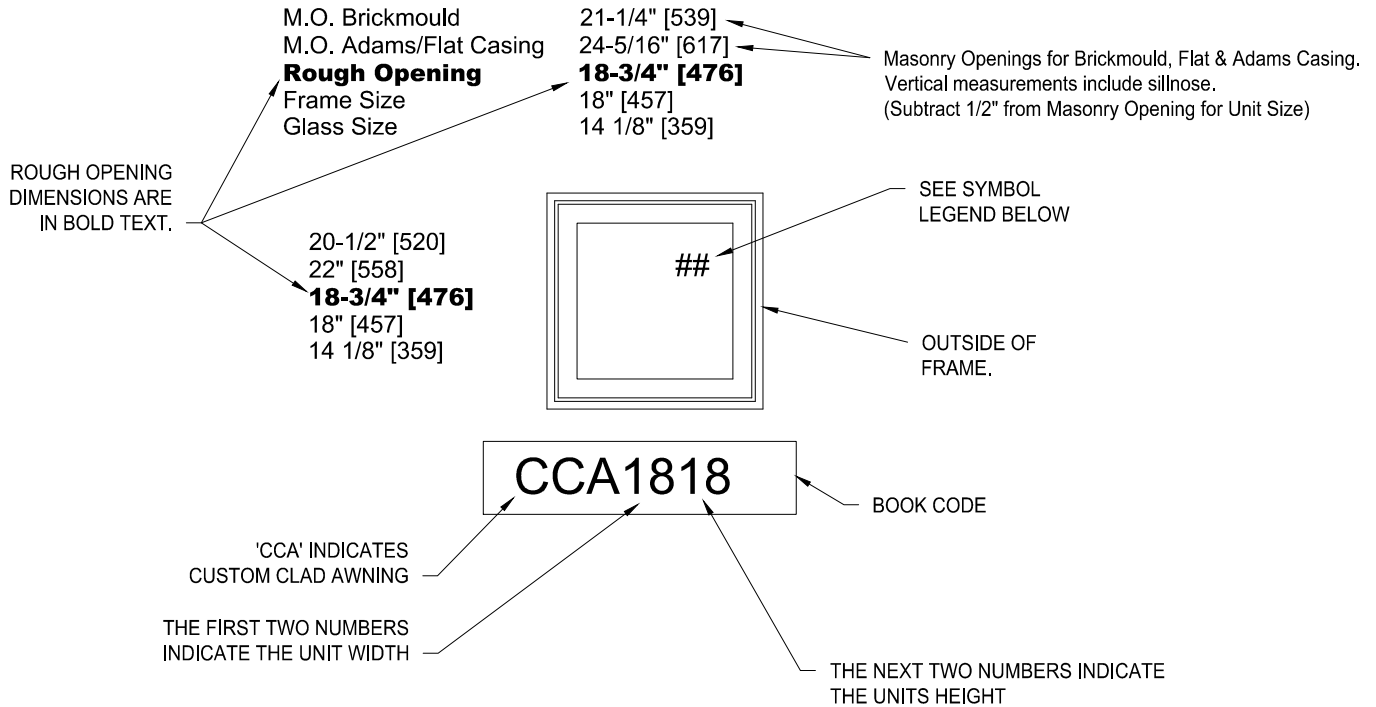

GENERAL AWNING NOTES

1. CUSTOM CLAD AWNING (CCA) UNITS ARE AVAILABLE AS OPERATING OR FIXED UNITS.
2. UNIT ELEVATIONS ARE SHOWN WITHOUT EXTERIOR TRIM.
3. DIMENSIONAL VALUES IN BRACKETS ARE MILLIMETER CONVERSIONS.

CLAD AWNING PICTURE COMBINATIONS

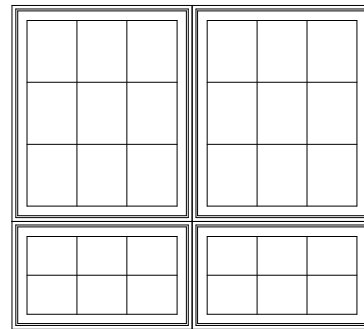

ELEVATION SYMBOL LEGEND:

- (F) THESE UNITS ARE ONLY AVAILABLE AS FIXED (STATIONARY) UNITS.
- ## NUMBER INDICATES DESIGN PRESSURE (DP) RATING WITH STANDARD GLAZING. OPERATING UNITS UTILIZE A CONCEALED LOCKING SYSTEM FOR DP RATINGS.

THE THIRD AND FOURTH NUMBERS OF THE BOOK CODE INDICATE THE PICTURE UNIT HEIGHT.

ELEVATIONS - SINGLE UNIT

MO BRICKMOLD	20 3/4"(527)	22 3/4"(578)	26 3/4"(679)	30 3/4"(781)	32 3/4"(832)	34 3/4"(883)	38 3/4"(784)
MO FLAT CASING	21 1/2"(546)	23 1/2"(597)	27 1/2"(699)	31 1/2"(800)	33 1/2"(851)	35 1/2"(902)	39 1/2"(1003)
ROUGH OPENING	18 3/4"(476)	20 3/4"(527)	24 3/4"(629)	28 3/4"(730)	30 3/4"(781)	32 3/4"(832)	36 3/4"(933)
FRAME SIZE	18"(457)	20"(508)	24"(610)	28"(711)	30"(762)	32"(813)	36"(914)
DAYLIGHT OPENING	13"(330)	15"(381)	19"(483)	23"(584)	25"(635)	27"(686)	31"(787)
16 3/4"(426) 17 1/2"(446) 14 3/4"(375) 14"(366) 8 13/32"(214)							
20 3/4"(527) 21 1/2"(546) 18 3/4"(476) 18"(457) 12 13/32"(315)							
22 3/4"(578) 23 1/2"(597) 20 3/4"(527) 20"(508) 14 13/32"(366)							
26 3/4"(679) 27 1/2"(699) 24 3/4"(629) 24"(610) 18 13/32"(468)							
30 3/4"(781) 31 1/2"(800) 28 3/4"(730) 28"(711) 22 13/32"(569)							
32 3/4"(832) 33 1/2"(851) 30 3/4"(781) 30"(762) 24 13/32"(620)							
34 3/4"(883) 35 1/2"(902) 32 3/4"(832) 32"(813) 26 13/32"(671)							
38 3/4"(984) 39 1/2"(1003) 36 3/4"(933) 36"(914) 30 13/32"(772)							
42 3/4"(1086) 43 1/2"(1105) 40 3/4"(1035) 40"(1016) 34 13/32"(874)							

ELEVATION SYMBOL LEGEND:

M.O. = MASORNY OPENING
VALUES IN () ARE IN MILLIMETER CONVERSIONS
NUMBER INDICATES DESIGN PRESSURE (DP) RATING WITH STANDARD GLAZING

Note: Elevations shown DO NOT have exterior trim. Subtract 1/2"(12.7) from M.O.(Masorny Opening) for Unit Sizes. Masorny openings above include Sill Nose, see Trim Options page for Sill Nose specifications. For other Trim Options refer to the Unit Sizing, Rough Opening & Masorny Openings page.

ELEVATIONS - SINGLE UNIT

	20 3/4"(527)	22 3/4"(578)	26 3/4"(679)	30 3/4"(781)	32 3/4"(832)	34 3/4"(883)	38 3/4"(784)
MO BRICKMOLD	20 3/4"(527)	22 3/4"(578)	26 3/4"(679)	30 3/4"(781)	32 3/4"(832)	34 3/4"(883)	38 3/4"(784)
MO FLAT CASING	21 1/2"(546)	23 1/2"(597)	27 1/2"(699)	31 1/2"(800)	33 1/2"(851)	35 1/2"(902)	39 1/2"(1003)
ROUGH OPENING	18 3/4"(476)	20 3/4"(527)	24 3/4"(629)	28 3/4"(730)	30 3/4"(781)	32 3/4"(832)	36 3/4"(933)
FRAME SIZE	18"(457)	20"(508)	24"(610)	28"(711)	30"(762)	32"(813)	36"(914)
DAYLIGHT OPENING	13"(330)	15"(381)	19"(483)	23"(584)	25"(635)	27"(686)	31"(787)

44 3/4"(1137)	45 1/2"(1156)	42 3/4"(1086)	42"(1067)	36 13/32"(925)			
CCA1842	CCA2042	CCA2442	CCA2842	CCA3042	CCA3242	CCA3642	

50 3/4"(1137)	51 1/2"(1156)	48 3/4"(1086)	48"(1219)	42 13/32"(1077)			
CCA1848	CCA2048	CCA2448	CCA2848	CCA3048	CCA3248	CCA3648	

ELEVATION SYMBOL LEGEND:

M.O. = MASORNY OPENING
 VALUES IN () ARE IN MILLIMETER CONVERSIONS
 NUMBER INDICATES DESIGN PRESSURE (DP) RATING WITH STANDARD GLAZING

Note: Elevations shown DO NOT have exterior trim. Subtract 1/2" (12.7) from M.O. (Masonry Opening) for Unit Sizes. Masonry openings above include Sill Nose, see Trim Options page for Sill Nose specifications. For other Trim Options refer to the Unit Sizing, Rough Opening & Masonry Openings page.

ELEVATIONS - SINGLE UNIT

MO BRICKMOLD
MO FLAT CASING
ROUGH OPENING
FRAME SIZE
DAYLIGHT OPENING

42 3/4"(1086)
43 1/2"(1105)
40 3/4"(1035)
40"(1016)
35"(889)

42 3/4"(1086)
43 1/2"(1105)
40 3/4"(1035)
42"(1067)
37"(940)

50 3/4"(1289)
51 1/2"(1308)
48 3/4"(1238)
48"(1219)
43"(1092)

56 3/4"(1442)
57 1/2"(1461)
54 3/4"(1391)
54"(1372)
49"(1245)

58 3/4"(1492)
59 1/2"(1511)
56 3/4"(1442)
56"(1422)
51"(1295)

16 3/4"(428)
17 1/2"(445)
14 3/4"(375)
14"(356)
8 13/32"(214)

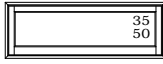

CCA4014



CCA4214



CCA4814

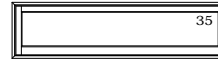

CCA5414

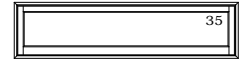

CCA5614

20 3/4"(527)
21 1/2"(546)
18 3/4"(476)
18"(457)
12 13/32"(315)

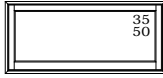

CCA4018

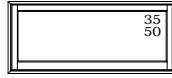

CCA4218

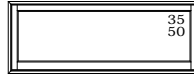

CCA4818

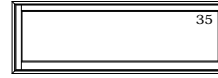

CCA5418

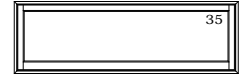

CCA5618

22 3/4"(578)
23 1/2"(597)
20 3/4"(527)
20"(508)
14 13/32"(366)



CCA4020



CCA4220



CCA4820



CCA5420



CCA5620

26 3/4"(679)
27 1/2"(699)
24 3/4"(629)
24"(610)
18 13/32"(468)



CCA4024



CCA4224



CCA4824



CCA5424



CCA5624

30 3/4"(781)
31 1/2"(800)
28 3/4"(730)
28"(711)
22 13/32"(569)



CCA4028



CCA4228



CCA4828



CCA5428



CCA5628

32 3/4"(832)
33 1/2"(851)
30 3/4"(781)
30"(762)
24 13/32"(620)



CCA4030

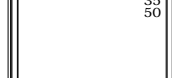

CCA4230

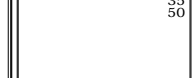

CCA4830



CCA5430



CCA5630

34 3/4"(883)
35 1/2"(902)
32 3/4"(832)
32"(813)
26 13/32"(671)



CCA4032

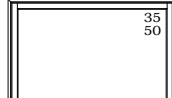

CCA4232



CCA4832



CCA5432



CCA5632

38 3/4"(984)
39 1/2"(1003)
36 3/4"(933)
36"(914)
30 13/32"(772)



CCA4036



CCA4236



CCA4836



CCA5436



CCA5636

42 3/4"(1086)
43 1/2"(1105)
40 3/4"(1035)
40"(1016)
34 13/32"(874)

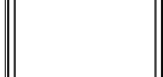

CCA4040



CCA4240



CCA4840



CCA5440



CCA5640

ELEVATION SYMBOL LEGEND:

M.O. = MASORNY OPENING

VALUES IN () ARE IN MILLIMETER CONVERSIONS

NUMBER INDICATES DESIGN PRESSURE (DP) RATING WITH STANDARD GLAZING

Note: Elevations shown DO NOT have exterior trim. Subtract 1/2"(12.7) from M.O.(Masonry Opening) for Unit Sizes. Masonry openings above include Sill Nose, see Trim Options page for Sill Nose specifications. For other Trim Options refer to the Unit Sizing, Rough Opening & Masonry Openings page.

ELEVATIONS - SINGLE UNIT

MO BRICKMOLD
MO FLAT CASING
ROUGH OPENING
FRAME SIZE
DAYLIGHT OPENING

42 3/4"(1086)
43 1/2"(1105)
40 3/4"(1035)
40"(1016)
35"(889)

42 3/4"(1086)
43 1/2"(1105)
40 3/4"(1035)
42"(1067)
37"(940)

50 3/4"(1289)
51 1/2"(1308)
48 3/4"(1238)
48"(1219)
43"(1092)

56 3/4"(1442)
57 1/2"(1461)
54 3/4"(1391)
54"(1372)
49"(1245)

58 3/4"(1492)
59 1/2"(1511)
56 3/4"(1442)
56"(1422)
51"(1295)

44 3/4"(1137)
45 1/2"(1156)
42 3/4"(1086)
42"(1067)
36 13/32"(925)

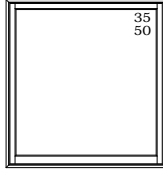

CCA4042

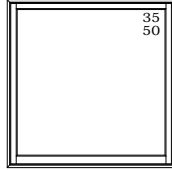

CCA4242

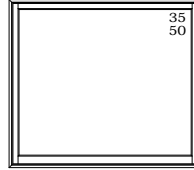

CCA4842

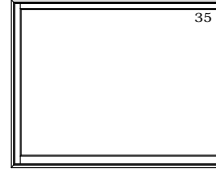

CCA5442



CCA5642

50 3/4"(1377)
51 1/2"(1396)
48 3/4"(1326)
48"(1307)
42 13/32"(1077)

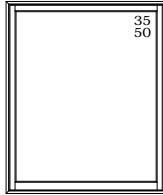

CCA4048

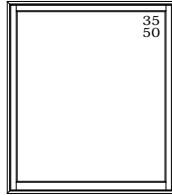

CCA4248

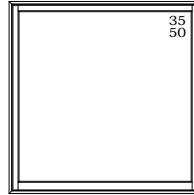

CCA4848

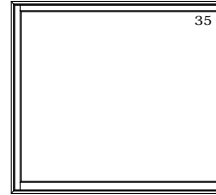

CCA5448

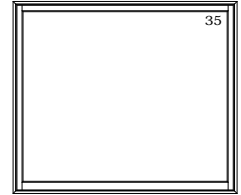

CCA5648

ELEVATION SYMBOL LEGEND:

M.O. = MASORNY OPENING
VALUES IN () ARE IN MILLIMETER CONVERSIONS
NUMBER INDICATES DESIGN PRESSURE (DP) RATING WITH STANDARD GLAZING

Note: Elevations shown DO NOT have exterior trim. Subtract 1/2"(12.7) from M.O.(Masonry Opening) for Unit Sizes. Masonry openings above include Sill Nose, see Trim Options page for Sill Nose specifications. For other Trim Options refer to the Unit Sizing, Rough Opening & Masonry Openings page.

ELEVATIONS - SINGLE UNIT

MO BRICKMOLD
MO FLAT CASING
ROUGH OPENING
FRAME SIZE
DAYLIGHT OPENING

62 3/4"(1594)
63 1/2"(1613)
60 3/4"(1543)
60"(1524)
55"(1397)

68 3/4"(1746)
69 1/2"(1765)
66 3/4"(1696)
66"(1676)
61"(1549)

74 3/4"(1899)
75 1/2"(1918)
72 3/4"(1848)
72"(1829)
67"(1702)

16 3/4"(426)
17 1/2"(445)
14 3/4"(375)
14"(366)
8 13/32"(214)

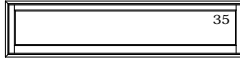

CCA6014

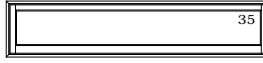

CCA6614

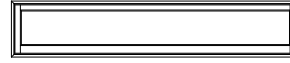

CCA7214

20 3/4"(527)
21 1/2"(546)
18 3/4"(476)
18"(457)
12 13/32"(315)

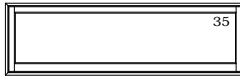

CCA6018

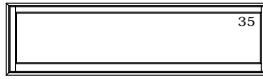

CCA6618

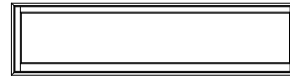

CCA7218

22 3/4"(578)
23 1/2"(597)
20 3/4"(527)
20"(508)
14 13/32"(366)



CCA6020



CCA6620



CCA7220

26 3/4"(679)
27 1/2"(699)
24 3/4"(629)
24"(610)
18 13/32"(488)

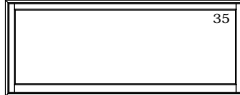

CCA6024

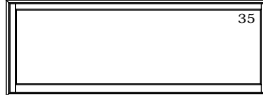

CCA6624

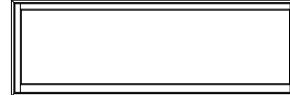

CCA7224

30 3/4"(781)
31 1/2"(800)
28 3/4"(730)
28"(711)
22 13/32"(569)

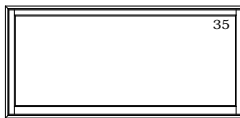

CCA6028

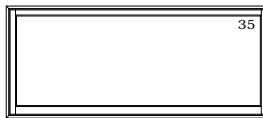

CCA6628

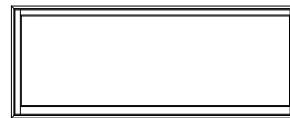

CCA7228

32 3/4"(832)
33 1/2"(851)
30 3/4"(781)
30"(762)
24 13/32"(620)

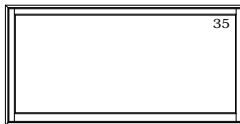

CCA6030

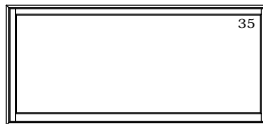

CCA6630

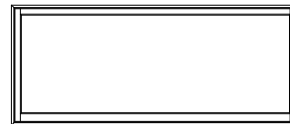

CCA7230

34 3/4"(883)
35 1/2"(902)
32 3/4"(832)
32"(813)
26 13/32"(671)



CCA6032

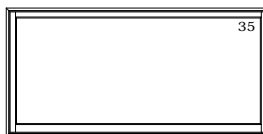

CCA6632

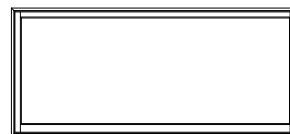

CCA7232

38 3/4"(984)
39 1/2"(1003)
36 3/4"(933)
36"(914)
30 13/32"(772)

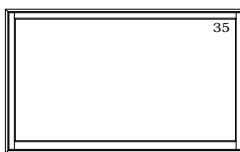

CCA6036

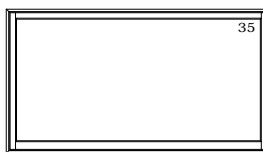

CCA6636

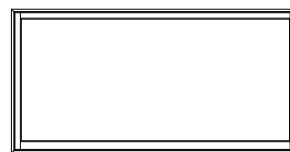

CCA7236

42 3/4"(1086)
43 1/2"(1105)
40 3/4"(1035)
40"(1016)
34 13/32"(874)



CCA6040



CCA6640



CCA7240

ELEVATION SYMBOL LEGEND:
M.O. = MASORNY OPENING
VALUES IN () ARE IN MILLIMETER CONVERSIONS
NUMBER INDICATES DESIGN PRESSURE (DP) RATING WITH STANDARD GLAZING

Note: Elevations shown DO NOT have exterior trim. Subtract 1/2"(12.7) from M.O.(Masonry Opening) for Unit Sizes. Masonry openings above include Sill Nose, see Trim Options page for Sill Nose specifications. For other Trim Options refer to the Unit Sizing, Rough Opening & Masonry Openings page.

ELEVATIONS - SINGLE UNIT

MO BRICKMOLD
MO FLAT CASING
ROUGH OPENING
FRAME SIZE
DAYLIGHT OPENING

62 3/4"(1594)
63 1/2"(1613)
60 3/4"(1543)
60"(1524)
55"(1397)

68 3/4"(1746)
69 1/2"(1765)
66 3/4"(1696)
66"(1676)
61"(1549)

74 3/4"(1899)
75 1/2"(1918)
72 3/4"(1848)
72"(1829)
67"(1702)

44 3/4"(1137)
45 1/2"(1156)
42 3/4"(1086)
42"(1067)
36 13/32"(925)



CCA6042



CCA6642



CCA7242

50 3/4"(1137)
51 1/2"(1156)
48 3/4"(1086)
48"(1219)
42 13/32"(1077)

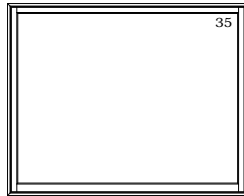

CCA6048

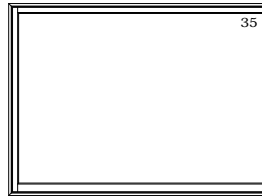

CCA6648

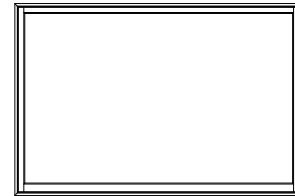

CCA7248

ELEVATION SYMBOL LEGEND:

M.O. = MASORNY OPENING
VALUES IN () ARE IN MILLIMETER CONVERSIONS
NUMBER INDICATES DESIGN PRESSURE (DP) RATING WITH STANDARD GLAZING

Note: Elevations shown DO NOT have exterior trim. Subtract 1/2"(12.7) from M.O.(Masorny Opening) for Unit Sizes. Masorny openings above include Sill Nose, see Trim Options page for Sill Nose specifications. For other Trim Options refer to the Unit Sizing, Rough Opening & Masorny Openings page.

ELEVATIONS
STATIONARY UNITS

MO BRICKMOLD	20 3/4"(527)	22 3/4"(578)	26 3/4"(679)	30 3/4"(781)	32 3/4"(832)	34 3/4"(883)	38 3/4"(784)
MO FLAT CASING	21 1/2"(546)	23 1/2"(597)	27 1/2"(699)	31 1/2"(800)	33 1/2"(851)	35 1/2"(902)	39 1/2"(1003)
ROUGH OPENING	18 3/4"(476)	20 3/4"(527)	24 3/4"(629)	28 3/4"(730)	30 3/4"(781)	32 3/4"(832)	36 3/4"(933)
FRAME SIZE	18"(457)	20"(508)	24"(610)	28"(711)	30"(762)	32"(813)	36"(914)
DAYLIGHT OPENING	13"(330)	15"(381)	19"(483)	23"(584)	25"(635)	27"(686)	31"(787)
16 3/4"(426) 17 1/2"(445) 14 3/4"(375) 14"(356) 8 13/32"(214)							
20 3/4"(527) 21 1/2"(546) 18 3/4"(476) 18 1/4"(457) 12 13/32"(315)							
22 3/4"(578) 23 1/2"(597) 20 3/4"(527) 20"(508) 14 13/32"(366)							
26 3/4"(679) 27 1/2"(699) 24 3/4"(629) 24"(610) 18 13/32"(466)							
30 3/4"(781) 31 1/2"(800) 28 3/4"(730) 28"(711) 22 13/32"(566)							
32 3/4"(832) 33 1/2"(851) 30 3/4"(781) 30"(762) 24 13/32"(620)							
34 3/4"(883) 35 1/2"(902) 32 3/4"(832) 32"(813) 26 13/32"(671)							
38 3/4"(984) 39 1/2"(1003) 36 3/4"(933) 36"(914) 30 13/32"(772)							
42 3/4"(1086) 43 1/2"(1105) 40 3/4"(1035) 40"(1016) 34 13/32"(874)							

ELEVATION SYMBOL LEGEND:

M.O. = MASORNY OPENING
VALUES IN () ARE IN MILLIMETER CONVERSIONS
NUMBER INDICATES DESIGN PRESSURE (DP) RATING WITH STANDARD GLAZING

Note: Elevations shown DO NOT have exterior trim. Subtract 1/2"(12.7) from M.O.(Masonry Opening) for Unit Sizes. Masonry openings above include Sill Nose, see Trim Options page for Sill Nose specifications. For other Trim Options refer to the Unit Sizing, Rough Opening & Masonry Opening page.

ELEVATIONS
STATIONARY UNITS

	20 3/4"(527)	22 3/4"(578)	26 3/4"(679)	30 3/4"(781)	32 3/4"(832)	34 3/4"(883)	38 3/4"(784)
MO BRICKMOLD	21 1/2"(546)	23 1/2"(597)	27 1/2"(699)	31 1/2"(800)	33 1/2"(851)	35 1/2"(902)	39 1/2"(1003)
MO FLAT CASING	18 3/4"(476)	20 3/4"(527)	24 3/4"(629)	28 3/4"(730)	30 3/4"(781)	32 3/4"(832)	36 3/4"(933)
ROUGH OPENING	18"(457)	20"(508)	24"(610)	28"(711)	30"(762)	32"(813)	36"(914)
FRAME SIZE	13"(330)	15"(381)	19"(483)	23"(584)	25"(635)	27"(686)	31"(787)
DAYLIGHT OPENING							

44 3/4"(1137)	45 1/2"(1156)	42 3/4"(1086)	42"(1067)	36 13/32"(925)			
50 3/4"(1137)	51 1/2"(1156)	48 3/4"(1086)	48"(1219)	42 13/32"(1077)			

CCA1842	CCA2042	CCA2442	CCA2842	CCA3042	CCA3242	CCA3642
CCA1848	CCA2048	CCA2448	CCA2848	CCA3048	CCA3248	CCA3648

ELEVATION SYMBOL LEGEND:

M.O. = MASORNY OPENING
 VALUES IN () ARE IN MILLIMETER CONVERSIONS
 NUMBER INDICATES DESIGN PRESSURE (DP) RATING WITH STANDARD GLAZING

Note: Elevations shown DO NOT have exterior trim. Subtract 1/2"(12.7) from M.O.(Masonry Opening) for Unit Sizes. Masonry openings above include Sill Nose, see Trim Options page for Sill Nose specifications. For other Trim Options refer to the Unit Sizing, Rough Opening & Masonry Openings page.

ELEVATIONS
STATIONARY UNITS

MO BRICKMOLD
MO FLAT CASING
ROUGH OPENING
FRAME SIZE
DAYLIGHT OPENING

42 3/4"(1086)
43 1/2"(1105)
40 3/4"(1035)
40"(1016)
35"(889)

42 3/4"(1086)
43 1/2"(1105)
40 3/4"(1035)
42"(1067)
37"(940)

50 3/4"(1289)
51 1/2"(1308)
48 3/4"(1238)
48"(1219)
43"(1092)

56 3/4"(1442)
57 1/2"(1461)
54 3/4"(1391)
54"(1372)
49"(1245)

58 3/4"(1492)
59 1/2"(1511)
56 3/4"(1442)
56"(1422)
51"(1295)

16 3/4"(426)
17 1/2"(445)
14 3/4"(375)
14"(366)
8 13/32"(214)



CCA4014

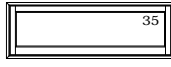

CCA4214

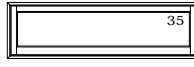

CCA4814



CCA5414



CCA5614

20 3/4"(527)
21 1/2"(546)
18 3/4"(476)
18"(457)
12 13/32"(315)

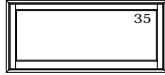

CCA4018

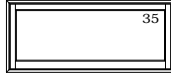

CCA4218

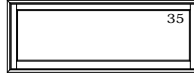

CCA4818

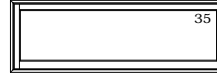

CCA5418

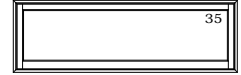

CCA5618

22 3/4"(578)
23 1/2"(597)
20 3/4"(527)
20"(508)
14 13/32"(366)

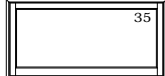

CCA4020

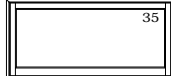

CCA4220

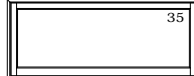

CCA4820

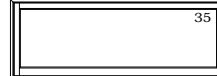

CCA5420

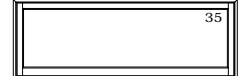

CCA5620

26 3/4"(679)
27 1/2"(699)
24 3/4"(629)
24"(610)
18 13/32"(468)



CCA4024



CCA4224



CCA4824



CCA5424



CCA5624

30 3/4"(781)
31 1/2"(800)
28 3/4"(730)
28"(711)
22 13/32"(569)



CCA4028



CCA4228



CCA4828



CCA5428

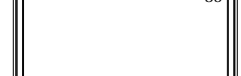

CCA5628

32 3/4"(832)
33 1/2"(851)
30 3/4"(781)
30"(762)
24 13/32"(620)



CCA4030



CCA4230

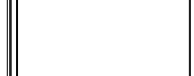

CCA4830



CCA5430



CCA5630

34 3/4"(883)
35 1/2"(902)
32 3/4"(832)
32"(813)
26 13/32"(671)



CCA4032



CCA4232



CCA4832



CCA5432

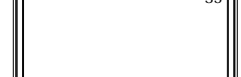

CCA5632

38 3/4"(984)
39 1/2"(1003)
36 3/4"(933)
36"(914)
30 13/32"(772)



CCA4036



CCA4236



CCA4836



CCA5436



CCA5636

42 3/4"(1086)
43 1/2"(1105)
40 3/4"(1035)
40"(1016)
34 13/32"(874)



CCA4040



CCA4240

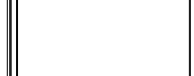

CCA4840



CCA5440



CCA5640

ELEVATION SYMBOL LEGEND:

M.O. = MASORNY OPENING
VALUES IN () ARE IN MILLIMETER CONVERSIONS
NUMBER INDICATES DESIGN PRESSURE (DP) RATING WITH STANDARD GLAZING

Note: Elevations shown DO NOT have exterior trim. Subtract 1/2"(12.7) from M.O.(Masonry Opening) for Unit Sizes. Masonry openings above include Sill Nose, see Trim Options page for Sill Nose specifications. For other Trim Options refer to the Unit Sizing, Rough Opening & Masonry Openings page.

ELEVATIONS
STATIONARY UNITS

MO BRICKMOLD
MO FLAT CASING
ROUGH OPENING
FRAME SIZE
DAYLIGHT OPENING

42 3/4"(1086)
43 1/2"(1105)
40 3/4"(1035)
40"(1016)
35"(889)

42 3/4"(1086)
43 1/2"(1105)
40 3/4"(1035)
42"(1067)
37"(940)

50 3/4"(1289)
51 1/2"(1308)
48 3/4"(1238)
48"(1219)
43"(1092)

56 3/4"(1442)
57 1/2"(1461)
54 3/4"(1391)
54"(1372)
49"(1245)

58 3/4"(1492)
59 1/2"(1511)
56 3/4"(1442)
56"(1422)
51"(1295)

44 3/4"(1137)
45 1/2"(1156)
42 3/4"(1086)
42"(1067)
36 13/32"(925)

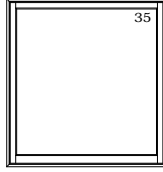

CCA4042

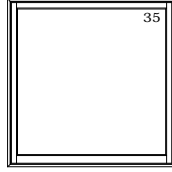

CCA4242

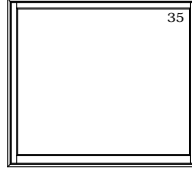

CCA4842

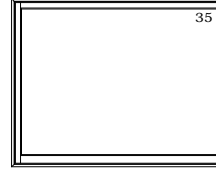

CCA5442



CCA5642

50 3/4"(1289)
51 1/2"(1308)
48 3/4"(1238)
48"(1219)
42 13/32"(1077)

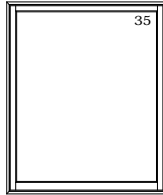

CCA4048

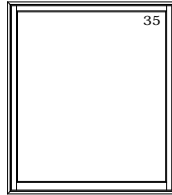

CCA4248

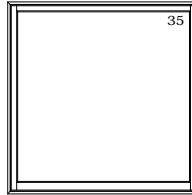

CCA4848

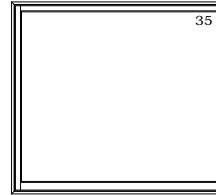

CCA5448

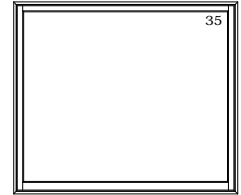

CCA5648

ELEVATION SYMBOL LEGEND:

M.O. = MASORNY OPENING
VALUES IN () ARE IN MILLIMETER CONVERSIONS
NUMBER INDICATES DESIGN PRESSURE (DP) RATING WITH STANDARD GLAZING

Note: Elevations shown DO NOT have exterior trim. Subtract 1/2"(12.7) from M.O.(Masonry Opening) for Unit Sizes. Masonry openings above include Sill Nose, see Trim Options page for Sill Nose specifications. For other Trim Options refer to the Unit Sizing, Rough Opening & Masonry Openings page.

ELEVATIONS
STATIONARY UNITS

MO BRICKMOLD
MO FLAT CASING
ROUGH OPENING
FRAME SIZE
DAYLIGHT OPENING

62 3/4"(1594)
63 1/2"(1613)
60 3/4"(1543)
60"(1524)
55"(1397)

68 3/4"(1746)
69 1/2"(1765)
66 3/4"(1696)
66"(1676)
61"(1549)

74 3/4"(1899)
75 1/2"(1918)
72 3/4"(1848)
72"(1829)
67"(1702)

16 3/4"(426)
17 1/2"(445)
14 3/4"(376)
14"(356)
8 13/32"(214)



CCA6014

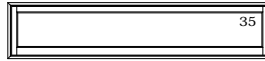

CCA6614



CCA7214

20 3/4"(527)
21 1/2"(546)
18 3/4"(476)
18"(467)
12 13/32"(315)



CCA6018



CCA6618



CCA7218

22 3/4"(578)
23 1/2"(597)
20 3/4"(527)
20"(508)
14 13/32"(366)



CCA6020



CCA6620



CCA7220

26 3/4"(679)
27 1/2"(699)
24 3/4"(629)
24"(610)
18 13/32"(468)



CCA6024

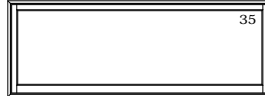

CCA6624

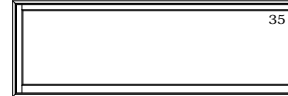

CCA7224

30 3/4"(781)
31 1/2"(800)
28 3/4"(730)
28"(711)
22 13/32"(569)

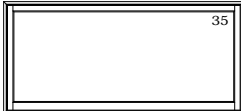

CCA6028

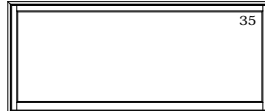

CCA6628

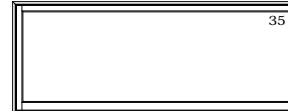

CCA7228

32 3/4"(832)
33 1/2"(851)
30 3/4"(781)
30"(762)
24 13/32"(620)

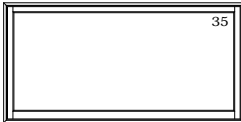

CCA6030

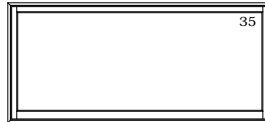

CCA6630

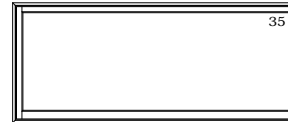

CCA7230

34 3/4"(883)
35 1/2"(902)
32 3/4"(832)
32"(813)
26 13/32"(671)

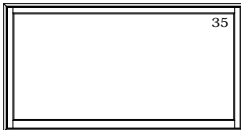

CCA6032

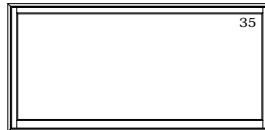

CCA6632

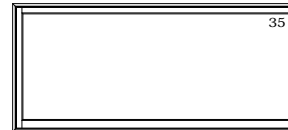

CCA7232

36 3/4"(934)
38 1/2"(983)
36 3/4"(933)
36"(914)
30 13/32"(772)



CCA6036



CCA6636



CCA7236

42 3/4"(1086)
43 1/2"(1105)
40 3/4"(1035)
40"(1016)
34 13/32"(874)

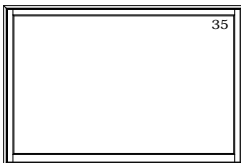

CCA6040

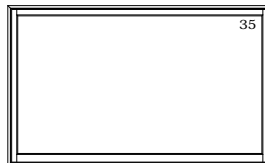

CCA6640

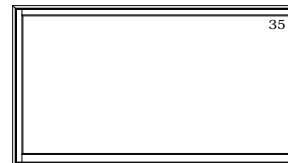

CCA7240

ELEVATION SYMBOL LEGEND:

M.O. = MASORNY OPENING
VALUES IN () ARE IN MILLIMETER CONVERSIONS
NUMBER INDICATES DESIGN PRESSURE (DP) RATING WITH STANDARD GLAZING

Note: Elevations shown DO NOT have exterior trim. Subtract 1/2"(12.7) from M.O.(Masonry Opening) for Unit Sizes. Masonry openings above include Sill Nose, see Trim Options page for Sill Nose specifications. For other Trim Options refer to the Unit Sizing, Rough Opening & Masonry Openings page.

ELEVATIONS
STATIONARY UNITS

MO BRICKMOLD
MO FLAT CASING
ROUGH OPENING
FRAME SIZE
DAYLIGHT OPENING

62 3/4"(1594)
63 1/2"(1613)
60 3/4"(1543)
60"(1524)
55"(1397)

68 3/4"(1746)
69 1/2"(1765)
66 3/4"(1696)
66"(1676)
61"(1549)

74 3/4"(1899)
75 1/2"(1918)
72 3/4"(1848)
72"(1829)
67"(1702)

44 3/4"(1137)
45 1/2"(1156)
42 3/4"(1086)
42"(1067)
36 13/32"(925)

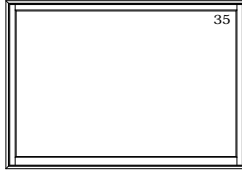

CCA6042

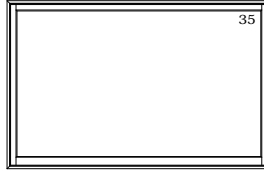

CCA6642

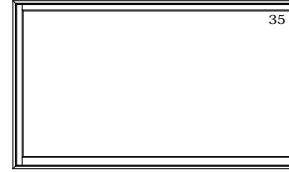

CCA7242

50 3/4"(1137)
51 1/2"(1156)
48 3/4"(1086)
48"(1219)
42 13/32"(1077)



CCA6048

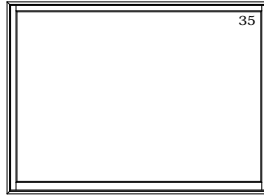

CCA6648



CCA7248

ELEVATION SYMBOL LEGEND:

M.O. = MASORNY OPENING
VALUES IN () ARE IN MILLIMETER CONVERSIONS
NUMBER INDICATES DESIGN PRESSURE (DP) RATING WITH STANDARD GLAZING

Note: Elevations shown DO NOT have exterior trim. Subtract 1/2" (12.7) from M.O. (Masonry Opening) for Unit Sizes. Masonry openings above include Sill Nose, see Trim Options page for Sill Nose specifications. For other Trim Options refer to the Unit Sizing, Rough Opening & Masonry Openings page.

ELEVATIONS
2-WIDE

	38 3/4"(984)	42 3/4"(1086)	50 3/4"(1289)	58 3/4"(1492)	62 3/4"(1594)	66 3/4"(1696)	74 3/4"(1899)
MO BRICKMOLD	41 13/16"(1062)	45 13/16"(1164)	53 13/16"(1367)	61 13/16"(1570)	65 13/16"(1672)	69 13/16"(1773)	77 13/16"(1976)
MO FLAT CASING							
ROUGH OPENING	36 3/4"(934)	40 3/4"(1035)	48 3/4"(1238)	56 3/4"(1442)	60 3/4"(1543)	64 3/4"(1645)	72 3/4"(1848)
FRAME SIZE	36"(914)	40"(1016)	48"(1219)	56"(1422)	60"(1524)	64"(1626)	72"(1829)
DAYLIGHT OPENING	13"(330)[2]	15"(381)[2]	19"(483)[2]	23"(584)[2]	25"(635)[2]	27"(686)[2]	31"(787)[2]
	16 3/4"(426)						
	19 13/32"(493)						
	14 3/4"(375)						
	14"(356)						
	18"(457)						
	12 13/32"(315)						
	20 3/4"(527)						
	23 13/32"(595)						
	18 3/4"(476)						
	18"(457)						
	22 3/4"(578)						
	25 13/32"(645)						
	20 3/4"(527)						
	20"(508)						
	14 13/32"(366)						
	26 3/4"(680)						
	29 13/32"(747)						
	24 3/4"(629)						
	24"(610)						
	18 13/32"(468)						
	30 3/4"(781)						
	33 13/32"(849)						
	28 3/4"(730)						
	28"(711)						
	22 13/32"(569)						
	32 3/4"(832)						
	35 13/32"(899)						
	30 3/4"(781)						
	30"(762)						
	24 13/32"(620)						
	34 3/4"(883)						
	37 13/32"(950)						
	32 3/4"(832)						
	32"(813)						
	26 13/32"(671)						
	38 3/4"(984)						
	41 13/32"(1052)						
	36 3/4"(934)						
	36"(914)						
	30 13/32"(772)						
	42 3/4"(1086)						
	45 13/32"(1153)						
	40 3/4"(1035)						
	40"(1016)						
	34 13/32"(874)						
	44 3/4"(1137)						
	47 13/32"(1204)						
	42 3/4"(1086)						
	42"(1067)						
	36 13/32"(925)						
	50 3/4"(1289)						
	53 13/32"(1357)						
	48 3/4"(1238)						
	48"(1219)						
	42 13/32"(1077)						

ELEVATION SYMBOL LEGEND:
M.O. = MASORNY OPENING
VALUES IN () ARE IN MILLIMETER CONVERSIONS

ELEVATIONS
2-WIDE

MO BRICKMOLD MO FLAT CASING ROUGH OPENING FRAME SIZE DAYLIGHT OPENING	82 3/4"(2102) 85 13/16"(2180) 80 3/4"(2051) 80"(2032) 35"(889)[2]	86 3/4"(2204) 89 13/16"(2281) 84 3/4"(2153) 84"(2134) 37"(940)[2]	98 3/4"(2508) 101 13/16"(2586) 96 3/4"(2458) 96"(2438) 43"(1092)[2]
16 3/4"(426) 19 13/32"(493) 14 3/4"(375) 14"(355) 8 13/32"(214)			
20 3/4"(527) 23 13/32"(595) 18 3/4"(476) 18"(457) 12 13/32"(315)			
22 3/4"(578) 25 13/32"(645) 20 3/4"(527) 20"(508) 14 13/32"(366)			
26 3/4"(680) 29 13/32"(747) 24 3/4"(628) 24"(610) 18 13/32"(468)			
30 3/4"(781) 33 13/32"(849) 28 3/4"(730) 28"(711) 22 13/32"(569)			
32 3/4"(832) 35 13/32"(899) 30 3/4"(781) 30"(762) 24 13/32"(620)			
34 3/4"(883) 37 13/32"(950) 32 3/4"(832) 32"(813) 26 13/32"(671)			
38 3/4"(984) 41 13/32"(1052) 36 3/4"(934) 36"(914) 30 13/32"(772)			
42 3/4"(1086) 45 13/32"(1153) 40 3/4"(1035) 40"(1016) 34 13/32"(874)			
44 3/4"(1137) 47 13/32"(1204) 42 3/4"(1086) 42"(1067) 36 13/32"(925)			
50 3/4"(1289) 53 13/32"(1357) 48 3/4"(1238) 48"(1219) 42 13/32"(1077)			

ELEVATION SYMBOL LEGEND:
M.O. = MASORNY OPENING
VALUES IN () ARE IN MILLIMETER CONVERSIONS

1 WIDE 1 HIGH ELEVATIONS

MO BRICKMOLD	32 3/4"(832)	34 3/4"(883)	38 3/4"(784)	42 3/4"(1086)	44 3/4"(1137)	50 3/4"(1289)
MO FLAT CASING	33 1/2"(851)	35 1/2"(902)	39 1/2"(1003)	43 1/2"(1105)	45 1/2"(1157)	51 1/2"(1308)
ROUGH OPENING	30 3/4"(781)	32 3/4"(832)	36 3/4"(933)	40 3/4"(1035)	42 3/4"(1086)	48 3/4"(1238)
FRAME SIZE	30"(762)	32"(813)	36"(914)	40"(1016)	42"(1067)	48"(1219)
DAYLIGHT OPENING	25"(635)	27"(686)	31"(787)	35"(889)	37"(940)	43"(1092)
38 3/4"(984) 41 13/16"(1016) 36 3/4"(933) 36"(914) 12 13/32"(315) [2]						
CA3018-12	CA3218-12	CA3618-12	CA4018-12	CA4218-12	CA4818-12	
42 3/4"(1086) 45 13/16"(1153) 40 3/4"(1035) 40"(1016) 14 13/32"(366) [2]						
CA3020-12	CA3220-12	CA3620-12	CA4020-12	CA4220-12	CA4820-12	
50 3/4"(1289) 53 13/16"(1357) 48 3/4"(1238) 48"(1219) 18 13/32"(469) [2]						
CA3024-12	CA3224-12	CA3624-12	CA4024-12	CA4224-12	CA4824-12	
58 3/4"(1492) 61 13/16"(1560) 56 3/4"(1442) 56"(1422) 22 13/32"(569) [2]						
CA3024-12	CA3224-12	CA3624-12	CA4024-12	CA4224-12	CA4824-12	
62 3/4"(1594) 65 13/16"(1661) 60 3/4"(1543) 60"(1524) 24 13/32"(620) [2]						
CA3028-12	CA3228-12	CA3628-12	CA4028-12	CA4228-12	CA4828-12	
66 3/4"(1696) 69 13/16"(1763) 64 3/4"(1645) 64"(1626) 26 13/32"(671) [2]						
CA3030-12	CA3230-12	CA3630-12	CA4030-12	CA4230-12	CA4830-12	
74 3/4"(1899) 77 13/16"(1966) 72 3/4"(1848) 72"(1829) 30 13/32"(772) [2]						
CA3032-12	CA3232-12	CA3632-12	CA4032-12	CA4232-12	CA4832-12	
82 3/4"(2102) 85 13/16"(2169) 80 3/4"(2051) 80"(2032) 34 13/32"(874) [2]						
CA3036-12	CA3236-12	CA3636-12	CA4036-12	CA4236-12	CA4836-12	
86 3/4"(2204) 89 13/16"(2271) 84 3/4"(2153) 84"(2134) 36 13/32"(925) [2]						
CA3040-12	CA3240-12	CA3640-12	CA4040-12	CA4240-12	CA4840-12	

ELEVATION SYMBOL LEGEND:
M.O. = MASORNY OPENING
VALUES IN () ARE IN MILLIMETER CONVERSIONS

Note: Elevations shown DO NOT have exterior trim. Subtract 1/2"(12.7) from M.O.(Masonry Opening) for Unit Sizes. Masonry openings above include Sill Nose, see Trim Options page for Sill Nose specifications. For other Trim Options refer to the Unit Sizing, Rough Opening & Masonry Openings page.

1 WIDE 1 HIGH ELEVATIONS

MO BRICKMOLD	32 3/4"(832)	34 3/4"(883)	38 3/4"(784)	42 3/4"(1086)	44 3/4"(1137)	50 3/4"(1289)
MO FLAT CASING	33 1/2"(851)	35 1/2"(902)	39 1/2"(1003)	43 1/2"(1105)	45 1/2"(1157)	51 1/2"(1308)
ROUGH OPENING	30 3/4"(781)	32 3/4"(832)	36 3/4"(933)	40 3/4"(1035)	42 3/4"(1086)	48 3/4"(1238)
FRAME SIZE	30"(762)	32"(813)	36"(914)	40"(1016)	42"(1067)	48"(1219)
DAYLIGHT OPENING	25"(635)	27"(686)	31"(787)	35"(889)	37"(940)	43"(1092)

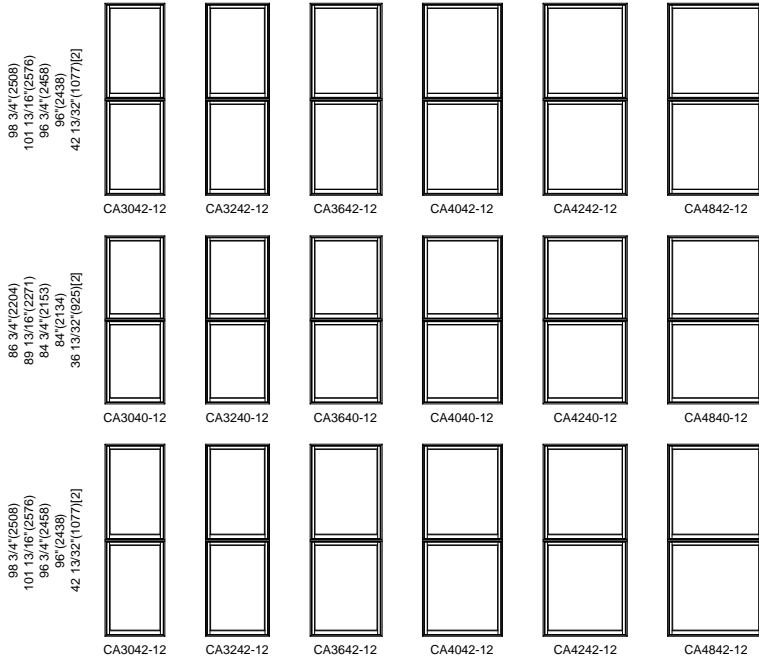

ELEVATION SYMBOL LEGEND:
M.O. = MASORNY OPENING
VALUES IN () ARE IN MILLIMETER CONVERSIONS

Note: Elevations shown DO NOT have exterior trim. Subtract 1/2"(12.7) from M.O.(Masonry Opening) for Unit Sizes. Masonry openings above include Sill Nose, see Trim Options page for Sill Nose specifications. For other Trim Options refer to the Unit Sizing, Rough Opening & Masonry Openings page.

2-WIDE 2-HIGH ELEVATION

MO BRICKMOLD
MO FLAT CASING
ROUGH OPENING
FRAME SIZE
DAYLIGHT OPENING

62 3/4"(1594)
65 13/16"(1672)
60 3/4"(1543)
60"(1524)
25"(635)[2]

66 3/4"(1696)
69 13/16"(1773)
64 3/4"(1645)
64"(1626)
27"(686)[2]

74 3/4"(1899)
77 13/16"(1976)
72 3/4"(1848)
72"(1829)
31"(787)[2]

82 3/4"(2102)
85 13/16"(2180)
80 3/4"(2051)
80"(2032)
35"(899)[2]

86 3/4"(2204)
89 13/16"(2281)
84 3/4"(2153)
84"(2134)
37"(940)[2]

98 3/4"(2508)
101 13/16"(2586)
96 3/4"(2458)
96"(2438)
43"(1092)[2]

38 3/4"(984)
41 13/16"(1016)
36 3/4"(933)
36"(914)
12 13/32"(315)[2]

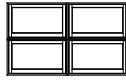

CCA3018-22

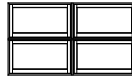

CCA3218-22

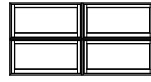

CCA3818-22

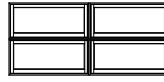

CCA4018-22

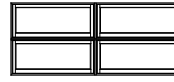

CCA4218-22

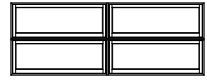

CCA4818-22

42 3/4"(1086)
45 13/16"(1163)
40 3/4"(1035)
40"(1016)
14 13/32"(366)[2]

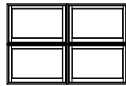

CCA3020-22

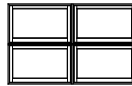

CCA3220-22

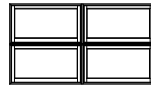

CCA3820-22

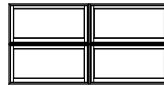

CCA4020-22

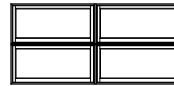

CCA4220-22

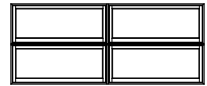

CCA4820-22

50 3/4"(1289)
53 13/16"(1367)
48 3/4"(1238)
48"(1219)
18 13/32"(468)[2]

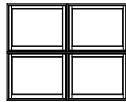

CCA3024-22

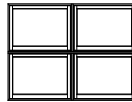

CCA3224-22

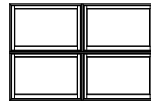

CCA3824-22

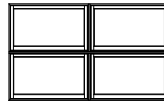

CCA4024-22

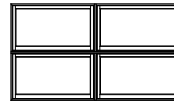

CCA4224-22

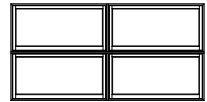

CCA4824-22

58 3/4"(1492)
61 13/16"(1569)
56 3/4"(1442)
56"(1423)
22 13/32"(569)[2]

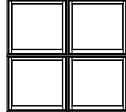

CCA3028-22

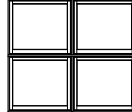

CCA3228-22

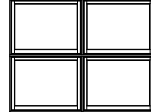

CCA3828-22

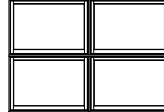

CCA4028-22

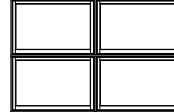

CCA4228-22

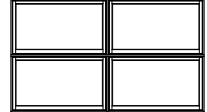

CCA4828-22

62 3/4"(1594)
65 13/16"(1671)
60 3/4"(1543)
60"(1524)
24 13/32"(620)[2]

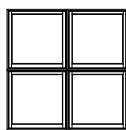

CCA3036-22

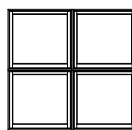

CCA3236-22

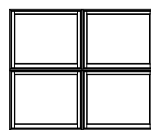

CCA3836-22

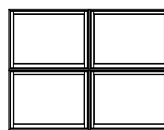

CCA4036-22

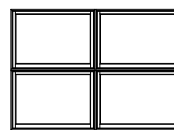

CCA4236-22

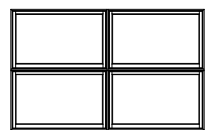

CCA4836-22

66 3/4"(1696)
69 13/16"(1773)
64 3/4"(1645)
64"(1626)
26 13/32"(671)[2]

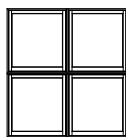

CCA3032-22

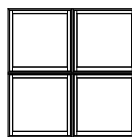

CCA3232-22

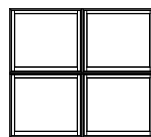

CCA3832-22

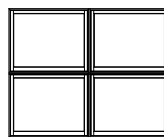

CCA4032-22

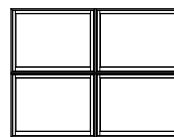

CCA4232-22

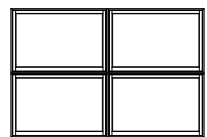

CCA4832-22

74 3/4"(1899)
77 13/16"(1976)
72 3/4"(1848)
72"(1829)
30 13/32"(772)[2]

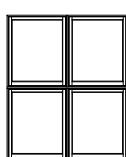

CCA3038-22

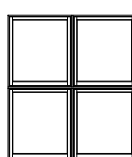

CCA3238-22

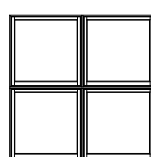

CCA3838-22

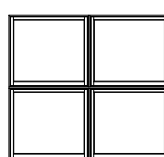

CCA4038-22

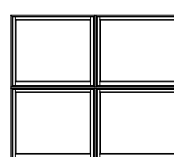

CCA4238-22

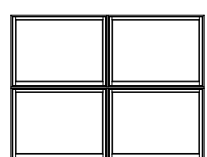

CCA4838-22

82 3/4"(2102)
85 13/16"(2180)
80 3/4"(2051)
80"(2032)
34 13/32"(874)[2]

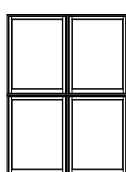

CCA3040-22

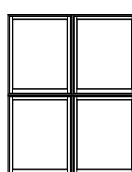

CCA3240-22

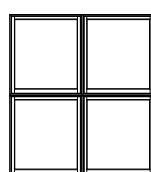

CCA3840-22

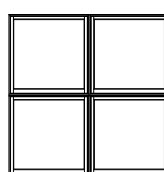

CCA4040-22

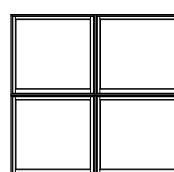

CCA4240-22

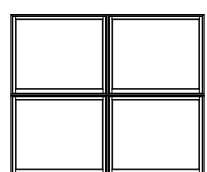

CCA4840-22

86 3/4"(2204)
89 13/16"(2281)
84 3/4"(2153)
84"(2134)
36 13/32"(925)[2]

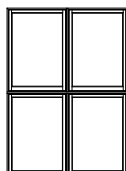

CCA3042-22

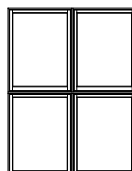

CCA3242-22

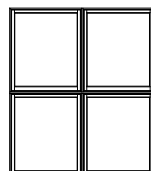

CCA3842-22

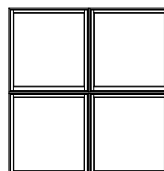

CCA4042-22

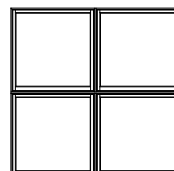

CCA4242-22

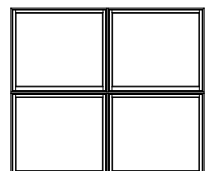

CCA4842-22

ELEVATION SYMBOL LEGEND:
M.O. = MASORNY OPENING
VALUES IN () ARE IN MILLIMETER CONVERSIONS

Note: Elevations shown DO NOT have exterior trim. Subtract 1/2"(12.7) from M.O.(Masonry Opening) for Unit Sizes. Masonry openings above include Sill Nose, see Trim Options page for Sill Nose specifications. For other Trim Options refer to the Unit Sizing, Rough Opening & Masonry Openings page.

2H X 2W ELEVATION

MO BRICKMOLD	62 3/4"(1594)	66 3/4"(1696)	74 3/4"(1899)	82 3/4"(2102)	86 3/4"(2204)	98 3/4"(2508)
MO FLAT CASING	65 13/16"(1672)	69 13/16"(1773)	77 13/16"(1976)	85 13/16"(2180)	89 13/16"(2281)	101 13/16"(2586)
ROUGH OPENING	60 3/4"(1543)	64 3/4"(1645)	72 3/4"(1848)	80 3/4"(2051)	84 3/4"(2153)	96 3/4"(2458)
FRAME SIZE	60"(1524)	64"(1626)	72"(1829)	80"(2032)	84"(2134)	96"(2438)
DAYLIGHT OPENING	25"(635)[2]	27"(686)[2]	31"(787)[2]	35"(889)[2]	37"(940)[2]	43"(1092)[2]

98 3/4"(2508)
101 13/16"(2576)
96 3/4"(2458)
96"(2438)
42 13/32"(1077)[2]

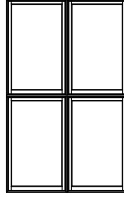

CC3048-22

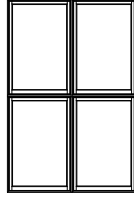

CC3248-22

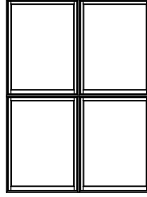

CC3448-22

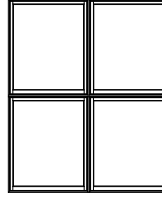

CC3648-22

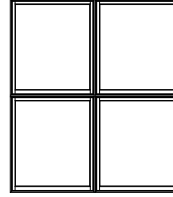

CC3848-22

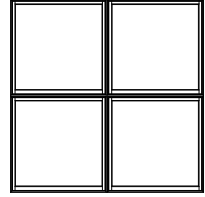

CC4048-22

ELEVATION SYMBOL LEGEND:
M.O. = MASORNY OPENING
VALUES IN () ARE IN MILLIMETER CONVERSIONS

Note: Elevations shown DO NOT have exterior trim. Subtract 1/2"(12.7) from M.O.(Masonry Opening) for Unit Sizes. Masonry openings above include Sill Nose, see Trim Options page for Sill Nose specifications. For other Trim Options refer to the Unit Sizing, Rough Opening & Masonry Openings page.

ELEVATIONS
30" WIDE X 36" HIGH PICTURE/AWNING
COMBINATION

MO BRICKMOLD	33 1/4"(845)	63 1/4"(1607)
MO FLAT CASING	37 5/16"(948)	67 5/16"(1710)
ROUGH OPENING	30 3/4"(781)	60 3/4"(1543)
FRAME SIZE	30"(762)	60"(1524)
DAYLIGHT OPENING	25"(635)	25"(635) [2]

57 1/4"(1454)
61 5/16"(1557)
54 3/4"(1391)
54"(1372)
30 13/32"(772) [1]
12 13/32"(315) [1]

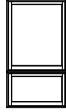

CCAP303618

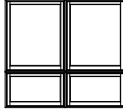

CCAP303618-2

59 1/4"(1505)
63 5/16"(1608)
56 3/4"(1441)
56"(1422)
30 13/32"(772) [1]
14 13/32"(366) [1]

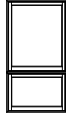

CCAP303620

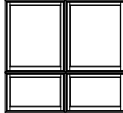

CCAP303620-2

63 1/4"(1607)
67 5/16"(1710)
60 3/4"(1543)
60"(1543)
30 13/32"(772) [1]
18 13/32"(468) [1]

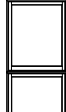

CCAP303624

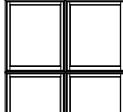

CCAP303624-2

67 1/4"(1708)
71 5/16"(1811)
64 3/4"(1645)
64"(1626)
30 13/32"(772) [1]
22 13/32"(569) [1]



CCAP303628

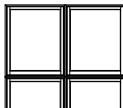

CCAP303628-2

69 1/4"(1759)
73 5/16"(1862)
66 3/4"(1695)
66"(1676)
30 13/32"(772) [1]
24 13/32"(620) [1]

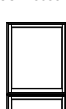

CCAP303630



CCAP303630-2

ELEVATION SYMBOL LEGEND:
M.O. = MASORNY OPENING
VALUES IN () ARE IN MILLIMETER CONVERSIONS

Note: Elevations shown include exterior sillnose and brickmold trim. Subtract 1/2"(12.7) from M.O.(Masonry Opening) for Unit Sizes. Masonry openings above include Sill Nose, see Trim Options page for Sill Nose specifications. For other Trim Options refer to the Unit Sizing, Rough Opening & Masonry Openings page.

**ELEVATIONS
30" WIDE X 40" HIGH PICTURE/AWNING
COMBINATION**

MO BRICKMOLD	33 1/4"(845)	63 1/4"(1607)
MO FLAT CASING	37 5/16"(948)	67 5/16"(1710)
ROUGH OPENING	30 3/4"(781)	60 3/4"(1543)
FRAME SIZE	30"(762)	60"(1524)
DAYLIGHT OPENING	25"(635)	25"(635) [2]

61 1/4"(1556)		
64 5/16"(1634)		
58 3/4"(1492)		
58"(1473)		
34 13/32"(874) [1] 12 13/32"(315) [1]		
CCAP304018	CCAP304018-2	

63 1/4"(1607)		
66 5/16"(1684)		
60 3/4"(1543)		
60"(1524)		
34 13/32"(874) [1] 14 13/32"(366) [1]		
CCAP304020	CCAP304020-2	

67 1/4"(1708)		
70 5/16"(1786)		
64 3/4"(1645)		
64"(1626)		
34 13/32"(874) [1] 18 13/32"(468) [1]		
CCAP304024	CCAP304024-2	

71 1/4"(1810)		
74 5/16"(1888)		
68 3/4"(1746)		
68"(1727)		
34 13/32"(874) [1] 22 13/32"(569) [1]		
CCAP304028	CCAP304028-2	

73 1/4"(1861)		
76 5/16"(1939)		
70 3/4"(1797)		
70"(1778)		
34 13/32"(874) [1] 24 13/32"(620) [1]		
CCAP304030	CCAP304030-2	

ELEVATION SYMBOL LEGEND:
M.O. = MASORNY OPENING
VALUES IN () ARE IN MILLIMETER CONVERSIONS

Note: Elevations shown include exterior sillnose and brickmold trim. Subtract 1/2"(12.7) from M.O. (Masonry Opening) for Unit Sizes. Masonry openings above include Sill Nose, see Trim Options page for Sill Nose specifications. For other Trim Options refer to the Unit Sizing, Rough Opening & Masonry Openings page.

**ELEVATIONS
30" WIDE X 42" HIGH PICTURE/AWNING
COMBINATION**

MO BRICKMOLD	33 1/4"(845)	63 1/4"(1607)
MO FLAT CASING	37 5/16"(948)	67 5/16"(1710)
ROUGH OPENING	30 3/4"(781)	60 3/4"(1543)
FRAME SIZE	30"(762)	60"(1524)
DAYLIGHT OPENING	25"(635)	25"(635) [2]

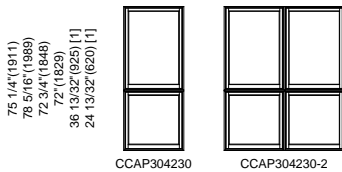
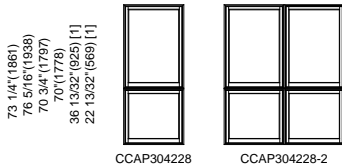
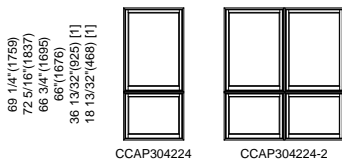
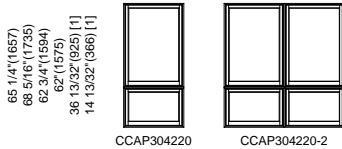
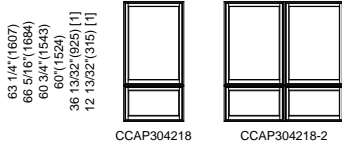

ELEVATION SYMBOL LEGEND:
M.O. = MASORNY OPENING
VALUES IN () ARE IN MILLIMETER CONVERSIONS

Note: Elevations shown include exterior sillnose and brickmold trim. Subtract 1/2"(12.7) from M.O.(Masonry Opening) for Unit Sizes. Masonry openings above include Sill Nose, see Trim Options page for Sill Nose specifications. For other Trim Options refer to the Unit Sizing, Rough Opening & Masonry Openings page.

**ELEVATIONS
30" WIDE X 48" HIGH PICTURE/AWNING
COMBINATION**

MO BRICKMOLD	33 1/4"(845)	63 1/4"(1607)
MO FLAT CASING	37 5/16"(948)	67 5/16"(1710)
ROUGH OPENING	30 3/4"(781)	60 3/4"(1543)
FRAME SIZE	30"(762)	60"(1524)
DAYLIGHT OPENING	25"(635)	25"(635) [2]



68 1/4"(1759) 72 5/16"(1837) 66 3/4"(1695) 66"(1654) 42 13/32"(1077) [1] 12 13/32"(315) [1]		
CCAP304818		CCAP304818-2
71 1/4"(1810) 74 5/16"(1888) 68 3/4"(1746) 68"(1727) 42 13/32"(1077) [1] 14 13/32"(366) [1]		
CCAP304820		CCAP304820-2
75 1/4"(1911) 78 5/16"(1989) 72 3/4"(1848) 72"(1829) 42 13/32"(1077) [1] 18 13/32"(468) [1]		
CCAP304824		CCAP304824-2
79 1/4"(2013) 82 5/16"(2091) 76 3/4"(1949) 76"(1930) 42 13/32"(1077) [1] 22 13/32"(569) [1]		
CCAP304828		CCAP304828-2
81 1/4"(2064) 84 5/16"(2142) 78 3/4"(2000) 78"(1981) 42 13/32"(1077) [1] 24 13/32"(620) [1]		
CCAP304830		CCAP304830-2

ELEVATION SYMBOL LEGEND:
M.O. = MASORNY OPENING
VALUES IN () ARE IN MILLIMETER CONVERSIONS

Note: Elevations shown include exterior sillnose and brickmold trim. Subtract 1/2"(12.7) from M.O.(Masonry Opening) for Unit Sizes. Masonry openings above include Sill Nose, see Trim Options page for Sill Nose specifications. For other Trim Options refer to the Unit Sizing, Rough Opening & Masonry Openings page.

ELEVATIONS
32" WIDE X 36" HIGH PICTURE/AWNING
COMBINATION

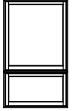
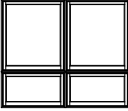
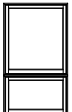
MO BRICKMOLD	35 1/4"(895)	67 1/4"(1708)
MO FLAT CASING	39 5/16"(999)	71 5/16"(1811)
ROUGH OPENING	32 3/4"(832)	64 3/4"(1645)
FRAME SIZE	32"(813)	64"(1626)
DAYLIGHT OPENING	27"(686)	27"(686) [2]

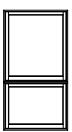
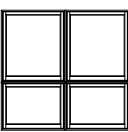
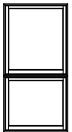
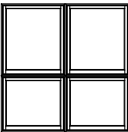
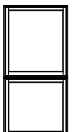
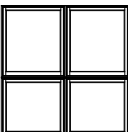
57 1/4"(1454) 61 5/16"(1557) 54 3/4"(1391) 54"(1372) 30 13/32"(772) [1] 12 13/32"(315) [1]		
	CCAP323618	CCAP323618-2
59 1/4"(1505) 63 5/16"(1608) 56 3/4"(1441) 56"(1422) 30 13/32"(772) [1] 14 13/32"(366) [1]		
	CCAP323620	CCAP323620-2
63 1/4"(1607) 67 5/16"(1710) 60 3/4"(1543) 60"(1543) 30 13/32"(772) [1] 18 13/32"(468) [1]		
	CCAP323624	CCAP323624-2
67 1/4"(1708) 71 5/16"(1811) 64 3/4"(1645) 64"(1626) 30 13/32"(772) [1] 22 13/32"(569) [1]		
	CCAP323628	CCAP323628-2
69 1/4"(1759) 73 5/16"(1862) 66 3/4"(1695) 66"(1676) 30 13/32"(772) [1] 24 13/32"(620) [1]		
	CCAP323630	CCAP323630-2

ELEVATION SYMBOL LEGEND:
M.O. = MASORNY OPENING
VALUES IN () ARE IN MILLIMETER CONVERSIONS

Note: Elevations shown include exterior sillnose and brickmold trim. Subtract 1/2"(12.7) from M.O. (Masonry Opening) for Unit Sizes. Masonry openings above include Sill Nose, see Trim Options page for Sill Nose specifications. For other Trim Options refer to the Unit Sizing, Rough Opening & Masonry Openings page.

**ELEVATIONS
32" WIDE X 40" HIGH PICTURE/AWNING
COMBINATION**

MO BRICKMOLD	35 1/4"(895)	67 1/4"(1708)
MO FLAT CASING	39 5/16"(999)	71 5/16"(1811)
ROUGH OPENING	32 3/4"(832)	64 3/4"(1645)
FRAME SIZE	32"(813)	64"(1626)
DAYLIGHT OPENING	27"(686)	27"(686) [2]

61 1/4"(1556)		
64 5/16"(1634)		
58 3/4"(1492)		
58"(1473)		
34 13/32"(874) [1]		
12 13/32"(315) [1]		
	CCAP324018	CCAP324018-2

63 1/4"(1607)		
66 5/16"(1684)		
60 3/4"(1543)		
60"(1524)		
34 13/32"(874) [1]		
14 13/32"(366) [1]		
	CCAP324020	CCAP324020-2

67 1/4"(1708)		
70 5/16"(1786)		
64 3/4"(1645)		
64"(1626)		
34 13/32"(874) [1]		
18 13/32"(468) [1]		
	CCAP324024	CCAP324024-2

71 1/4"(1810)		
74 5/16"(1888)		
68 3/4"(1746)		
68"(1727)		
34 13/32"(874) [1]		
22 13/32"(569) [1]		
	CCAP324028	CCAP324028-2

73 1/4"(1861)		
76 5/16"(1939)		
70 3/4"(1797)		
70"(1778)		
34 13/32"(874) [1]		
24 13/32"(620) [1]		
	CCAP324030	CCAP324030-2

ELEVATION SYMBOL LEGEND:
M.O. = MASORNY OPENING
VALUES IN () ARE IN MILLIMETER CONVERSIONS

Note: Elevations shown include exterior sillnose and brickmold trim. Subtract 1/2"(12.7) from M.O.(Masonry Opening) for Unit Sizes. Masonry openings above include Sill Nose, see Trim Options page for Sill Nose specifications. For other Trim Options refer to the Unit Sizing, Rough Opening & Masonry Openings page.

**ELEVATIONS
32" WIDE X 42" HIGH PICTURE/AWNING
COMBINATION**

MO BRICKMOLD	35 1/4"(895)	67 1/4"(1708)
MO FLAT CASING	39 5/16"(999)	71 5/16"(1811)
ROUGH OPENING	32 3/4"(832)	64 3/4"(1645)
FRAME SIZE	32"(813)	64"(1626)
DAYLIGHT OPENING	27"(686)	27"(686) [2]

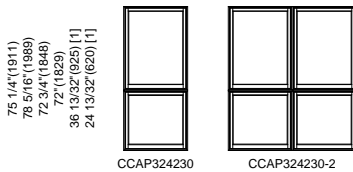
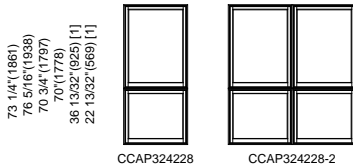
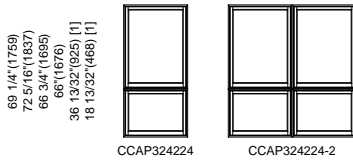
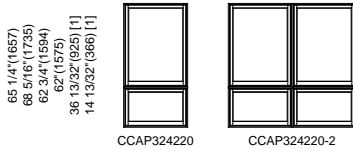
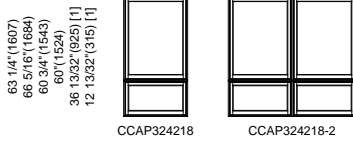

ELEVATION SYMBOL LEGEND:
M.O. = MASORNY OPENING
VALUES IN () ARE IN MILLIMETER CONVERSIONS

Note: Elevations shown include exterior sillnose and brickmold trim. Subtract 1/2"(12.7) from M.O.(Masonry Opening) for Unit Sizes. Masonry openings above include Sill Nose, see Trim Options page for Sill Nose specifications. For other Trim Options refer to the Unit Sizing, Rough Opening & Masonry Openings page.

**ELEVATIONS
32" WIDE X 48" HIGH PICTURE/AWNING
COMBINATION**

MO BRICKMOLD	35 1/4"(895)	67 1/4"(1708)
MO FLAT CASING	39 5/16"(999)	71 5/16"(1811)
ROUGH OPENING	32 3/4"(832)	64 3/4"(1645)
FRAME SIZE	32"(813)	64"(1626)
DAYLIGHT OPENING	27"(686)	27"(686) [2]

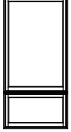
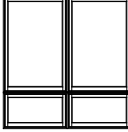
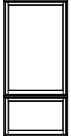
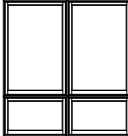
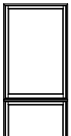
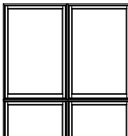
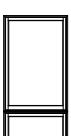
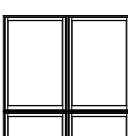
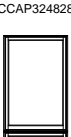
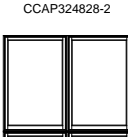
68 1/4"(1759) 72 5/16"(1837) 66 3/4"(1695) 66"(1654) 42 13/32"(1077) [1] 12 13/32"(315) [1]		
	CCAP324818	CCAP324818-2
71 1/4"(1810) 74 5/16"(1888) 68 3/4"(1746) 68"(1727) 42 13/32"(1077) [1] 14 13/32"(366) [1]		
	CCAP324820	CCAP324820-2
75 1/4"(1911) 78 5/16"(1989) 72 3/4"(1848) 72"(1829) 42 13/32"(1077) [1] 18 13/32"(468) [1]		
	CCAP324824	CCAP324824-2
79 1/4"(2013) 82 5/16"(2091) 76 3/4"(1949) 76"(1930) 42 13/32"(1077) [1] 22 13/32"(569) [1]		
	CCAP324828	CCAP324828-2
81 1/4"(2064) 84 5/16"(2142) 78 3/4"(2000) 78"(1981) 42 13/32"(1077) [1] 24 13/32"(620) [1]		
	CCAP324830	CCAP324830-2

ELEVATION SYMBOL LEGEND:
M.O. = MASORNY OPENING
VALUES IN () ARE IN MILLIMETER CONVERSIONS

Note: Elevations shown include exterior sillnose and brickmold trim. Subtract 1/2"(12.7) from M.O.(Masonry Opening) for Unit Sizes. Masonry openings above include Sill Nose, see Trim Options page for Sill Nose specifications. For other Trim Options refer to the Unit Sizing, Rough Opening & Masonry Openings page.

**ELEVATIONS
36" WIDE X 36" HIGH PICTURE/AWNING
COMBINATION**

MO BRICKMOLD	39 1/4"(987)	75 1/4"(1911)
MO FLAT CASING	43 5/16"(1100)	79 5/16"(2015)
ROUGH OPENING	36 3/4"(933)	72 3/4"(1848)
FRAME SIZE	36"(914)	72"(1829)
DAYLIGHT OPENING	31"(787)	31"(787) [2]

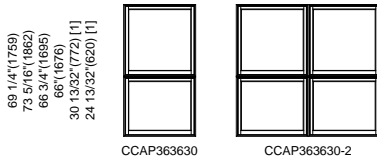
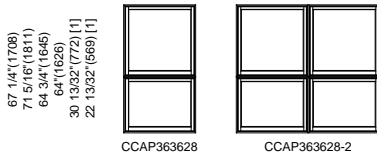
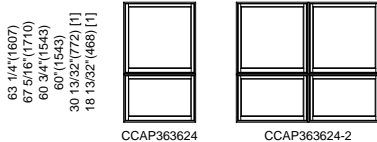
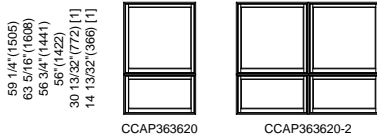
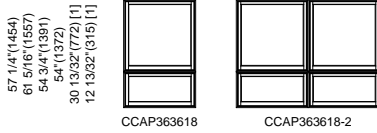

ELEVATION SYMBOL LEGEND:
M.O. = MASORNY OPENING
VALUES IN () ARE IN MILLIMETER CONVERSIONS

Note: Elevations shown include exterior sillnose and brickmold trim. Subtract 1/2"(12.7) from M.O.(Masonry Opening) for Unit Sizes. Masonry openings above include Sill Nose, see Trim Options page for Sill Nose specifications. For other Trim Options refer to the Unit Sizing, Rough Opening & Masonry Openings page.

**ELEVATIONS
36" WIDE X 40" HIGH PICTURE/AWNING
COMBINATION**

MO BRICKMOLD	39 1/4"(987)	75 1/4"(1911)
MO FLAT CASING	43 5/16"(1100)	79 5/16"(2015)
ROUGH OPENING	36 3/4"(933)	72 3/4"(1848)
FRAME SIZE	36"(914)	72"(1829)
DAYLIGHT OPENING	31"(787)	31"(787) [2]

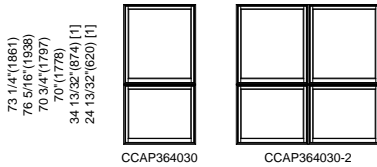
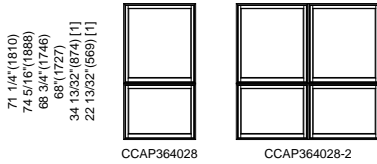
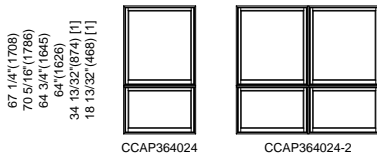
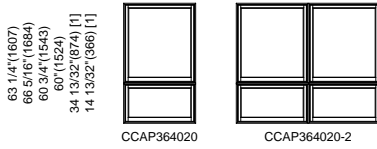
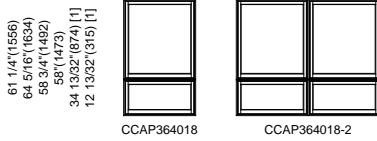

ELEVATION SYMBOL LEGEND:
M.O. = MASORNY OPENING
VALUES IN () ARE IN MILLIMETER CONVERSIONS

Note: Elevations shown include exterior sillnose and brickmold trim. Subtract 1/2"(12.7) from M.O.(Masonry Opening) for Unit Sizes. Masonry openings above include Sill Nose, see Trim Options page for Sill Nose specifications. For other Trim Options refer to the Unit Sizing, Rough Opening & Masonry Openings page.

**ELEVATIONS
36" WIDE X 42" HIGH PICTURE/AWNING
COMBINATION**

MO BRICKMOLD 39 1/4"(987)
MO FLAT CASING 43 5/16"(1100)
ROUGH OPENING 36 3/4"(933)
FRAME SIZE 36"(914)
DAYLIGHT OPENING 31"(787)

75 1/4"(1911)
79 5/16"(2015)
72 3/4"(1848)
72"(1829)
31"(787) [2]

63 1/4"(1607)
66 5/16"(1684)
60 3/4"(1543)
60"(1524)
36 13/32"(925) [1]
12 13/32"(315) [1]

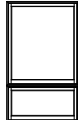

CCAP364218



CCAP364218-2

65 1/4"(1657)
68 5/16"(1735)
62 3/4"(1594)
62"(1575)
36 13/32"(925) [1]
14 13/32"(366) [1]

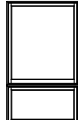

CCAP364220



CCAP364220-2

69 1/4"(1759)
72 5/16"(1837)
66 3/4"(1695)
66"(1676)
36 13/32"(925) [1]
18 13/32"(468) [1]

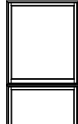

CCAP364224



CCAP364224-2

73 1/4"(1861)
76 5/16"(1938)
70 3/4"(1797)
70"(1778)
36 13/32"(925) [1]
22 13/32"(569) [1]

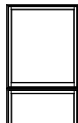

CCAP364228



CCAP364228-2

75 1/4"(1911)
78 5/16"(1989)
72 3/4"(1848)
72"(1829)
36 13/32"(925) [1]
24 13/32"(620) [1]

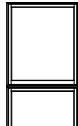

CCAP364230

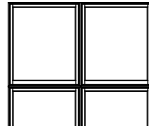

CCAP364230-2

ELEVATION SYMBOL LEGEND:
M.O. = MASORNY OPENING
VALUES IN () ARE IN MILLIMETER CONVERSIONS

Note: Elevations shown include exterior sillnose and brickmold trim. Subtract 1/2"(12.7) from M.O.(Masonry Opening) for Unit Sizes. Masonry openings above include Sill Nose, see Trim Options page for Sill Nose specifications. For other Trim Options refer to the Unit Sizing, Rough Opening & Masonry Openings page.

**ELEVATIONS
36" WIDE X 48" HIGH PICTURE/AWNING
COMBINATION**

MO BRICKMOLD	39 1/4"(987)	75 1/4"(1911)
MO FLAT CASING	43 5/16"(1100)	79 5/16"(2015)
ROUGH OPENING	36 3/4"(933)	72 3/4"(1848)
FRAME SIZE	36"(914)	72"(1829)
DAYLIGHT OPENING	31"(787)	31"(787) [2]

68 1/4"(1759)
72 5/16"(1837)
66 3/4"(1695)
66"(1654)
42 13/32"(1077) [1]
12 13/32"(315) [1]

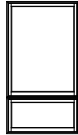

CCAP364818

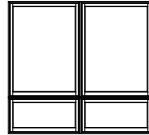

CCAP364818-2

71 1/4"(1810)
74 5/16"(1888)
68 3/4"(1746)
68"(1727)
42 13/32"(1077) [1]
14 13/32"(366) [1]

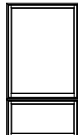

CCAP364820

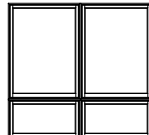

CCAP364820-2

75 1/4"(1911)
78 5/16"(1989)
72 3/4"(1848)
72"(1829)
42 13/32"(1077) [1]
18 13/32"(468) [1]

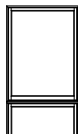

CCAP364824

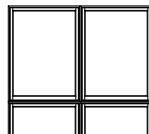

CCAP364824-2

79 1/4"(2013)
82 5/16"(2091)
76 3/4"(1949)
76"(1930)
42 13/32"(1077) [1]
22 13/32"(569) [1]

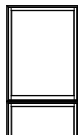

CCAP364828

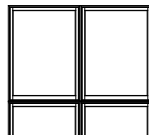

CCAP364828-2

81 1/4"(2064)
84 5/16"(2142)
78 3/4"(2000)
78"(1981)
42 13/32"(1077) [1]
24 13/32"(620) [1]



CCAP364830

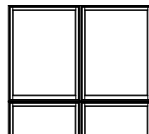

CCAP364830-2

ELEVATION SYMBOL LEGEND:
M.O. = MASORNY OPENING
VALUES IN () ARE IN MILLIMETER CONVERSIONS

Note: Elevations shown include exterior sillnose and brickmold trim. Subtract 1/2"(12.7) from M.O.(Masonry Opening) for Unit Sizes. Masonry openings above include Sill Nose, see Trim Options page for Sill Nose specifications. For other Trim Options refer to the Unit Sizing, Rough Opening & Masonry Openings page.

**ELEVATIONS
42" WIDE X 36" HIGH PICTURE/AWNING
COMBINATION**

MO BRICKMOLD	45 1/4"(1149)	87 1/4"(2216)
MO FLAT CASING	49 5/16"(1253)	91 5/16"(2319)
ROUGH OPENING	42 3/4"(1086)	84 3/4"(2153)
FRAME SIZE	42"(1067)	84"(2134)
DAYLIGHT OPENING	37"(940)	37"(940) [2]

57 1/4"(1454)
61 5/16"(1557)
54 3/4"(1391)
54"(1372)
30 13/32"(772) [1]
12 13/32"(315) [1]

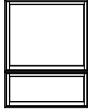

CCAP423618



CCAP423618-2

59 1/4"(1505)
63 5/16"(1608)
56 3/4"(1441)
56"(1422)
30 13/32"(772) [1]
14 13/32"(366) [1]

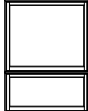

CCAP423620



CCAP423620-2

63 1/4"(1607)
67 5/16"(1710)
60 3/4"(1543)
60"(1543)
30 13/32"(772) [1]
18 13/32"(468) [1]

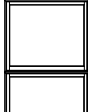

CCAP423624



CCAP423624-2

67 1/4"(1708)
71 5/16"(1811)
64 3/4"(1645)
64"(1626)
30 13/32"(772) [1]
22 13/32"(569) [1]

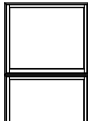

CCAP423628

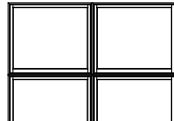

CCAP423628-2

69 1/4"(1759)
73 5/16"(1862)
66 3/4"(1695)
66"(1676)
30 13/32"(772) [1]
24 13/32"(620) [1]

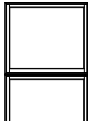

CCAP423630

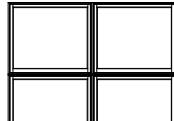

CCAP423630-2

ELEVATION SYMBOL LEGEND:
M.O. = MASORNY OPENING
VALUES IN () ARE IN MILLIMETER CONVERSIONS

Note: Elevations shown include exterior sillnose and brickmold trim. Subtract 1/2"(12.7) from M.O.(Masonry Opening) for Unit Sizes. Masonry openings above include Sill Nose, see Trim Options page for Sill Nose specifications. For other Trim Options refer to the Unit Sizing, Rough Opening & Masonry Openings page.

**ELEVATIONS
42" WIDE X 40" HIGH PICTURE/AWNING
COMBINATION**

MO BRICKMOLD	45 1/4"(1149)	87 1/4"(2216)
MO FLAT CASING	49 5/16"(1253)	91 5/16"(2319)
ROUGH OPENING	42 3/4"(1086)	84 3/4"(2153)
FRAME SIZE	42"(1067)	84"(2134)
DAYLIGHT OPENING	37"(940)	37"(940) [2]

61 1/4"(1556)
64 5/16"(1634)
58 3/4"(1492)
58"(1473)
34 13/32"(874) [1]
12 13/32"(315) [1]

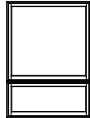

CCAP424018



CCAP424018-2

63 1/4"(1607)
66 5/16"(1684)
60 3/4"(1543)
60"(1524)
34 13/32"(874) [1]
14 13/32"(366) [1]

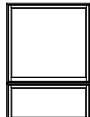

CCAP424020



CCAP424020-2

67 1/4"(1708)
70 5/16"(1786)
64 3/4"(1645)
64"(1626)
34 13/32"(874) [1]
18 13/32"(468) [1]

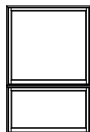

CCAP424024



CCAP424024-2

71 1/4"(1810)
74 5/16"(1888)
68 3/4"(1746)
68"(1727)
34 13/32"(874) [1]
22 13/32"(569) [1]

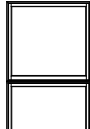

CCAP424028

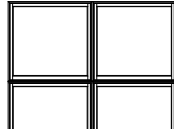

CCAP424028-2

73 1/4"(1861)
76 5/16"(1939)
70 3/4"(1797)
70"(1778)
34 13/32"(874) [1]
24 13/32"(620) [1]

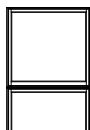

CCAP424030

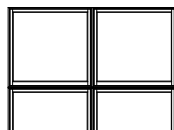

CCAP424030-2

ELEVATION SYMBOL LEGEND:
M.O. = MASORNY OPENING
VALUES IN () ARE IN MILLIMETER CONVERSIONS

Note: Elevations shown include exterior sillnose and brickmold trim. Subtract 1/2"(12.7) from M.O.(Masonry Opening) for Unit Sizes. Masonry openings above include Sill Nose, see Trim Options page for Sill Nose specifications. For other Trim Options refer to the Unit Sizing, Rough Opening & Masonry Openings page.

**ELEVATIONS
42" WIDE X 42" HIGH PICTURE/AWNING
COMBINATION**

MO BRICKMOLD	45 1/4"(1149)	87 1/4"(2216)
MO FLAT CASING	49 5/16"(1253)	91 5/16"(2319)
ROUGH OPENING	42 3/4"(1086)	84 3/4"(2153)
FRAME SIZE	42"(1067)	84"(2134)
DAYLIGHT OPENING	37"(940)	37"(940) [2]

63 1/4"(1607)
66 5/16"(1684)
60 3/4"(1543)
60"(1524)
36 13/32"(925) [1]
12 13/32"(315) [1]

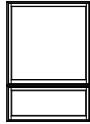

CCAP424218

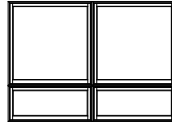

CCAP424218-2

65 1/4"(1657)
68 5/16"(1735)
62 3/4"(1594)
62"(1575)
36 13/32"(925) [1]
14 13/32"(366) [1]

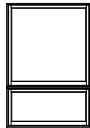

CCAP424220



CCAP424220-2

69 1/4"(1759)
72 5/16"(1837)
66 3/4"(1695)
66"(1676)
36 13/32"(925) [1]
18 13/32"(468) [1]

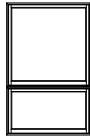

CCAP424224



CCAP424224-2

73 1/4"(1861)
76 5/16"(1938)
70 3/4"(1797)
70"(1778)
36 13/32"(925) [1]
22 13/32"(569) [1]

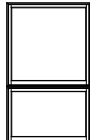

CCAP424228



CCAP424228-2

75 1/4"(1911)
78 5/16"(1989)
72 3/4"(1848)
72"(1829)
36 13/32"(925) [1]
24 13/32"(620) [1]

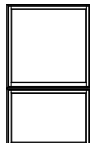

CCAP424230



CCAP424230-2

ELEVATION SYMBOL LEGEND:
M.O. = MASORNY OPENING
VALUES IN () ARE IN MILLIMETER CONVERSIONS

Note: Elevations shown include exterior sillnose and brickmold trim. Subtract 1/2"(12.7) from M.O.(Masonry Opening) for Unit Sizes. Masonry openings above include Sill Nose, see Trim Options page for Sill Nose specifications. For other Trim Options refer to the Unit Sizing, Rough Opening & Masonry Openings page.

**ELEVATIONS
42" WIDE X 48" HIGH PICTURE/AWNING
COMBINATION**

MO BRICKMOLD	45 1/4"(1149)	87 1/4"(2216)
MO FLAT CASING	49 5/16"(1253)	91 5/16"(2319)
ROUGH OPENING	42 3/4"(1086)	84 3/4"(2153)
FRAME SIZE	42"(1067)	84"(2134)
DAYLIGHT OPENING	37"(940)	37"(940) [2]

68 1/4"(1759)
72 5/16"(1837)
66 3/4"(1695)
66"(1654)
42 13/32"(1077) [1]
12 13/32"(315) [1]

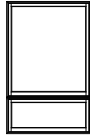

CCAP424818

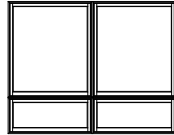

CCAP424818-2

71 1/4"(1810)
74 5/16"(1888)
68 3/4"(1746)
68"(1727)
42 13/32"(1077) [1]
14 13/32"(366) [1]

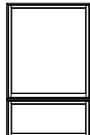

CCAP424820



CCAP424820-2

75 1/4"(1911)
78 5/16"(1989)
72 3/4"(1848)
72"(1829)
42 13/32"(1077) [1]
18 13/32"(468) [1]

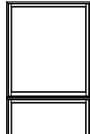

CCAP424824



CCAP424824-2

79 1/4"(2013)
82 5/16"(2091)
76 3/4"(1949)
76"(1930)
42 13/32"(1077) [1]
22 13/32"(569) [1]

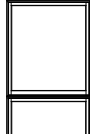

CCAP424828



CCAP424828-2

81 1/4"(2064)
84 5/16"(2142)
78 3/4"(2000)
78"(1981)
42 13/32"(1077) [1]
24 13/32"(620) [1]

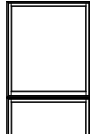

CCAP424830







CCAP424830-2

ELEVATION SYMBOL LEGEND:
M.O. = MASORNY OPENING
VALUES IN () ARE IN MILLIMETER CONVERSIONS

Note: Elevations shown include exterior sillnose and brickmold trim. Subtract 1/2"(12.7) from M.O.(Masonry Opening) for Unit Sizes. Masonry openings above include Sill Nose, see Trim Options page for Sill Nose specifications. For other Trim Options refer to the Unit Sizing, Rough Opening & Masonry Openings page.

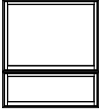
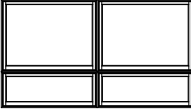
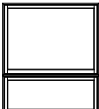
**ELEVATIONS
48" WIDE X 36" HIGH PICTURE/AWNING
COMBINATION**

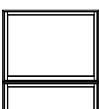
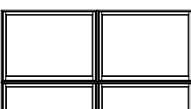
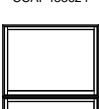
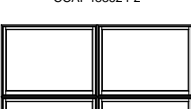
MO BRICKMOLD	51 1/4"(1302)	99 1/4"(2521)
MO FLAT CASING	55 5/16"(1405)	103 5/16"(2624)
ROUGH OPENING	48 3/4"(1238)	96 3/4"(2457)
FRAME SIZE	48"(1219)	96"(2438)
DAYLIGHT OPENING	43"(1092)	43"(1092) [2]

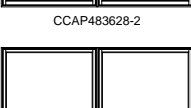



57 1/4"(1454) 61 5/16"(1557) 54 3/4"(1391) 54"(1372) 30 13/32"(772) [1] 12 13/32"(315) [1]		
	CCAP483618	CCAP483618-2
59 1/4"(1505) 63 5/16"(1608) 56 3/4"(1441) 56"(1422) 30 13/32"(772) [1] 14 13/32"(366) [1]		
	CCAP483620	CCAP483620-2
63 1/4"(1607) 67 5/16"(1710) 60 3/4"(1543) 60"(1543) 30 13/32"(772) [1] 18 13/32"(468) [1]		
	CCAP483624	CCAP483624-2
67 1/4"(1708) 71 5/16"(1811) 64 3/4"(1645) 64"(1626) 30 13/32"(772) [1] 22 13/32"(569) [1]		
	CCAP483628	CCAP483628-2
69 1/4"(1759) 73 5/16"(1862) 66 3/4"(1695) 66"(1676) 30 13/32"(772) [1] 24 13/32"(620) [1]		
	CCAP483630	CCAP483630-2

ELEVATION SYMBOL LEGEND:
M.O. = MASORNY OPENING
VALUES IN () ARE IN MILLIMETER CONVERSIONS

Note: Elevations shown include exterior sillnose and brickmold trim. Subtract 1/2"(12.7) from M.O. (Masonry Opening) for Unit Sizes. Masonry openings above include Sill Nose, see Trim Options page for Sill Nose specifications. For other Trim Options refer to the Unit Sizing, Rough Opening & Masonry Openings page.

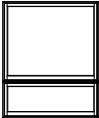
**ELEVATIONS
48" WIDE X 40" HIGH PICTURE/AWNING
COMBINATION**

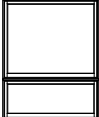
MO BRICKMOLD	51 1/4"(1302)	99 1/4"(2521)
MO FLAT CASING	55 5/16"(1405)	103 5/16"(2624)
ROUGH OPENING	48 3/4"(1238)	96 3/4"(2457)
FRAME SIZE	48"(1219)	96"(2438)
DAYLIGHT OPENING	43"(1092)	43"(1092) [2]

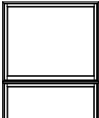
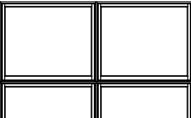
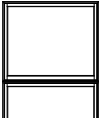
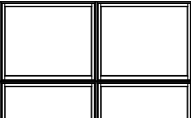
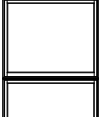
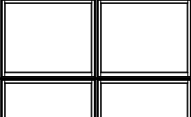



61 1/4"(1556) 64 5/16"(1634) 58 3/4"(1492) 58"(1473) 34 13/32"(874) [1] 12 13/32"(315) [1]		
	CCAP484018	CCAP484018-2
63 1/4"(1607) 66 5/16"(1684) 60 3/4"(1543) 60"(1524) 34 13/32"(874) [1] 14 13/32"(366) [1]		
	CCAP484020	CCAP484020-2
67 1/4"(1708) 70 5/16"(1786) 64 3/4"(1645) 64"(1626) 34 13/32"(874) [1] 18 13/32"(468) [1]		
	CCAP484024	CCAP484024-2
71 1/4"(1810) 74 5/16"(1888) 68 3/4"(1746) 68"(1727) 34 13/32"(874) [1] 22 13/32"(569) [1]		
	CCAP484028	CCAP484028-2
73 1/4"(1861) 76 5/16"(1939) 70 3/4"(1797) 70"(1778) 34 13/32"(874) [1] 24 13/32"(620) [1]		
	CCAP484030	CCAP484030-2

ELEVATION SYMBOL LEGEND:
M.O. = MASORNY OPENING
VALUES IN () ARE IN MILLIMETER CONVERSIONS

Note: Elevations shown include exterior sillnose and brickmold trim. Subtract 1/2"(12.7) from M.O.(Masonry Opening) for Unit Sizes. Masonry openings above include Sill Nose, see Trim Options page for Sill Nose specifications. For other Trim Options refer to the Unit Sizing, Rough Opening & Masonry Openings page.

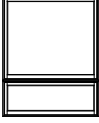
**ELEVATIONS
48" WIDE X 42" HIGH PICTURE/AWNING
COMBINATION**

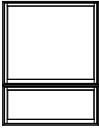
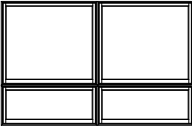
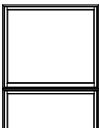
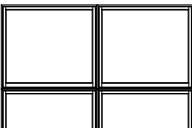
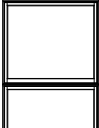
MO BRICKMOLD	51 1/4"(1302)	99 1/4"(2521)
MO FLAT CASING	55 5/16"(1405)	103 5/16"(2624)
ROUGH OPENING	48 3/4"(1238)	96 3/4"(2457)
FRAME SIZE	48"(1219)	96"(2438)
DAYLIGHT OPENING	43"(1092)	43"(1092) [2]

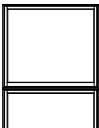
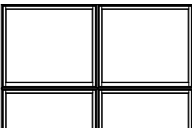

63 1/4"(1607) 66 5/16"(1684) 60 3/4"(1543) 60"(1524) 36 13/32"(925) [1] 12 13/32"(315) [1]		
	CCAP484218	CCAP484218-2
65 1/4"(1657) 68 5/16"(1735) 62 3/4"(1594) 62"(1575) 36 13/32"(925) [1] 14 13/32"(366) [1]		
	CCAP484220	CCAP484220-2
69 1/4"(1759) 72 5/16"(1837) 66 3/4"(1695) 66"(1676) 36 13/32"(925) [1] 18 13/32"(468) [1]		
	CCAP484224	CCAP484224-2
73 1/4"(1861) 76 5/16"(1938) 70 3/4"(1797) 70"(1778) 36 13/32"(925) [1] 22 13/32"(569) [1]		
	CCAP484228	CCAP484228-2
75 1/4"(1911) 78 5/16"(1989) 72 3/4"(1848) 72"(1829) 36 13/32"(925) [1] 24 13/32"(620) [1]		
	CCAP484230	CCAP484230-2

ELEVATION SYMBOL LEGEND:
M.O. = MASORNY OPENING
VALUES IN () ARE IN MILLIMETER CONVERSIONS

Note: Elevations shown include exterior sillnose and brickmold trim. Subtract 1/2"(12.7) from M.O.(Masonry Opening) for Unit Sizes. Masonry openings above include Sill Nose, see Trim Options page for Sill Nose specifications. For other Trim Options refer to the Unit Sizing, Rough Opening & Masonry Openings page.

**ELEVATIONS
48" WIDE X 48" HIGH PICTURE/AWNING
COMBINATION**

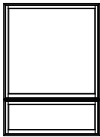
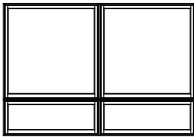
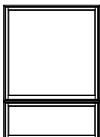
MO BRICKMOLD	51 1/4"(1302)	99 1/4"(2521)
MO FLAT CASING	55 5/16"(1405)	103 5/16"(2624)
ROUGH OPENING	48 3/4"(1238)	96 3/4"(2457)
FRAME SIZE	48"(1219)	96"(2438)
DAYLIGHT OPENING	43"(1092)	43"(1092) [2]

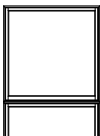
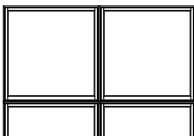
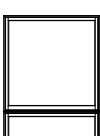
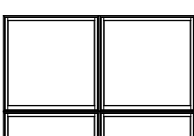
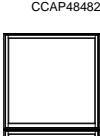
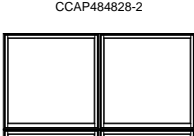
68 1/4"(1759) 72 5/16"(1837) 66 3/4"(1695) 66"(1654) 42 13/32"(1077) [1] 12 13/32"(315) [1]		
	CCAP484818	CCAP484818-2
71 1/4"(1810) 74 5/16"(1888) 68 3/4"(1746) 68"(1727) 42 13/32"(1077) [1] 14 13/32"(366) [1]		
	CCAP484820	CCAP484820-2
75 1/4"(1911) 78 5/16"(1989) 72 3/4"(1848) 72"(1829) 42 13/32"(1077) [1] 18 13/32"(468) [1]		
	CCAP484824	CCAP484824-2
79 1/4"(2013) 82 5/16"(2091) 76 3/4"(1949) 76"(1930) 42 13/32"(1077) [1] 22 13/32"(569) [1]		
	CCAP484828	CCAP484828-2
81 1/4"(2064) 84 5/16"(2142) 78 3/4"(2000) 78"(1981) 42 13/32"(1077) [1] 24 13/32"(620) [1]		
	CCAP484830	CCAP484830-2

ELEVATION SYMBOL LEGEND:
M.O. = MASORNY OPENING
VALUES IN () ARE IN MILLIMETER CONVERSIONS

Note: Elevations shown include exterior sillnose and brickmold trim. Subtract 1/2"(12.7) from M.O.(Masonry Opening) for Unit Sizes. Masonry openings above include Sill Nose, see Trim Options page for Sill Nose specifications. For other Trim Options refer to the Unit Sizing, Rough Opening & Masonry Openings page.

**INTERIOR GLAZED GLAZING OPTIONS
INSULATED 15/16" [24] GLASS**

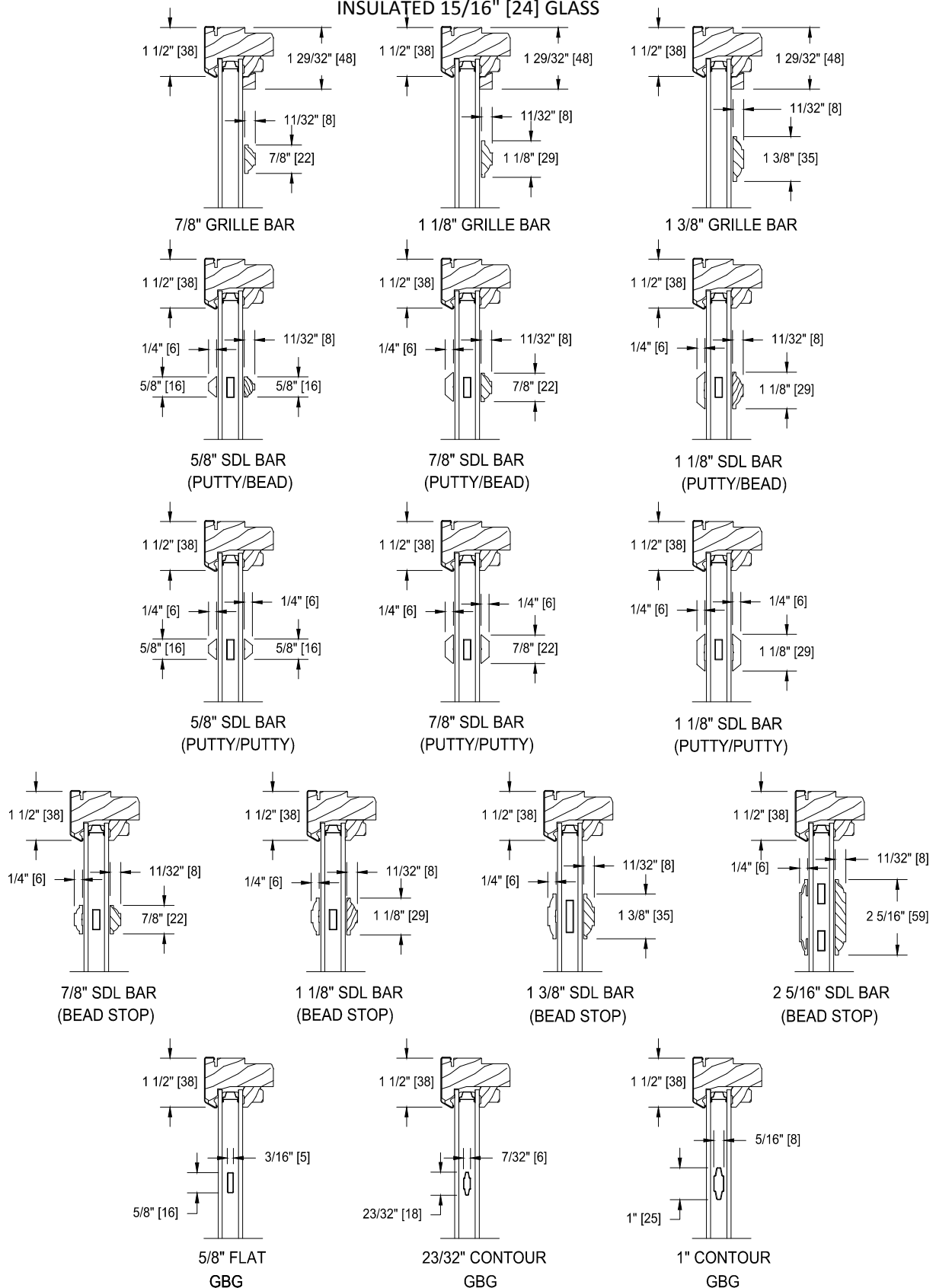

INTERIOR GLAZED GLAZING OPTIONS
SINGLE GLAZED 1/8" [3] GLASS

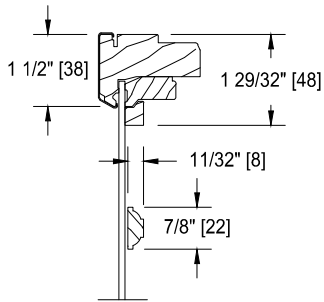

7/8" GRILLE BAR

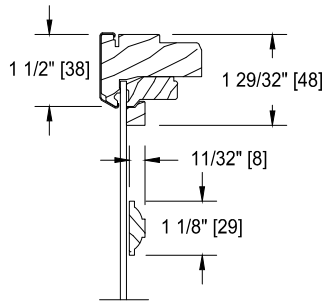

1 1/8" GRILLE BAR

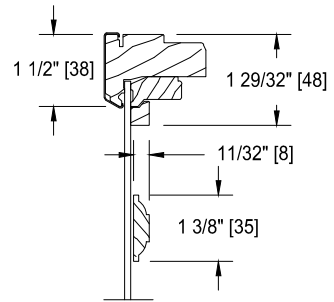

1 3/8" GRILLE BAR

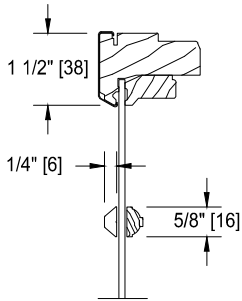

**5/8" SDL
(PUTTY/BEAD)**

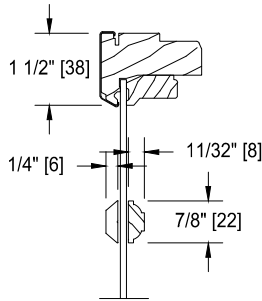

**7/8" SDL
(PUTTY/BEAD)**

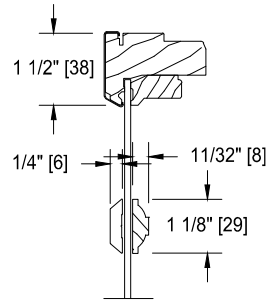

**1 1/8" SDL
(PUTTY/BEAD)**

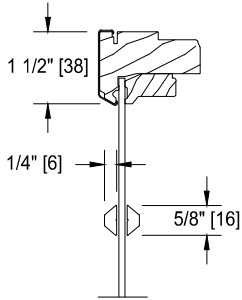

**5/8" SDL
(PUTTY/PUTTY)**

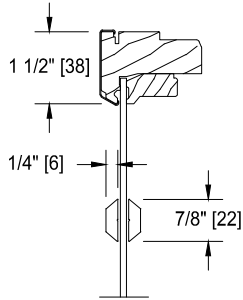

**7/8" SDL
(PUTTY/PUTTY)**

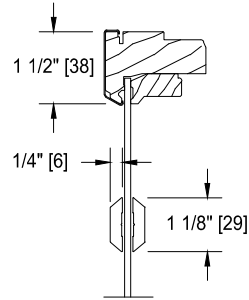

**1 1/8" SDL
(PUTTY/PUTTY)**

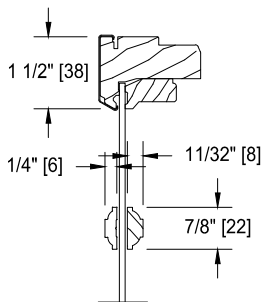

**7/8" SDL
(BEAD STOP)**

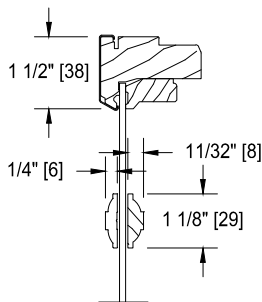

**1 1/8" SDL
(BEAD STOP)**

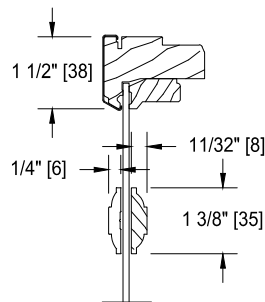

**1 3/8" SDL
(BEAD STOP)**

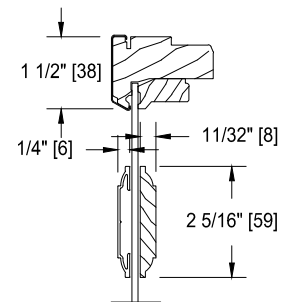

**2 5/16" SDL BAR
(BEAD STOP)**

INTERIOR GLAZED GLAZING OPTIONS
IMPACT RESISTANT GLASS

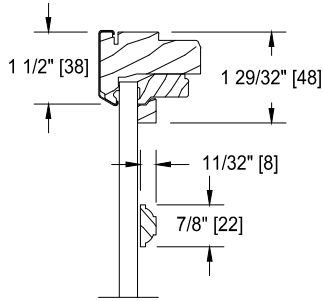

7/8" GRILLE BAR

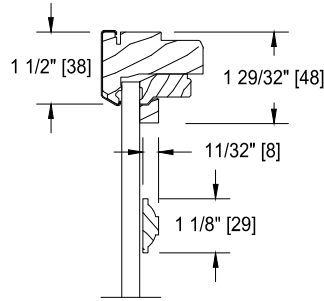

1 1/8" GRILLE BAR

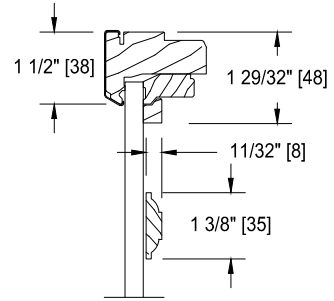

1 3/8" GRILLE BAR

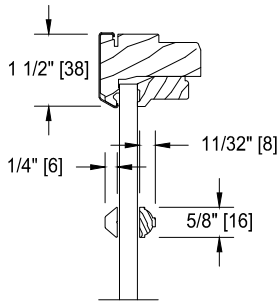

5/8" SDL
(PUTTY/BEAD)

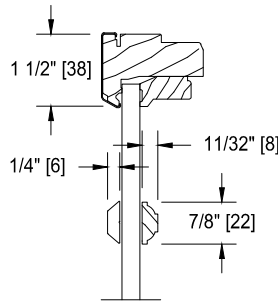

7/8" SDL
(PUTTY/BEAD)

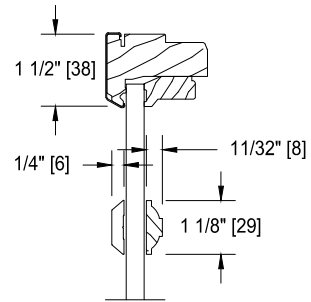

1 1/8" SDL
(PUTTY/BEAD)

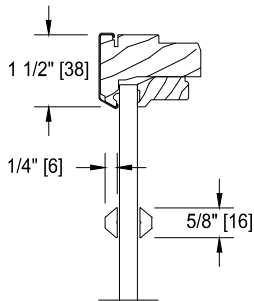

5/8" SDL
(PUTTY/PUTTY)

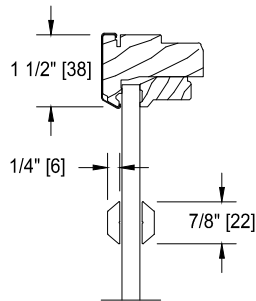

7/8" SDL
(PUTTY/PUTTY)

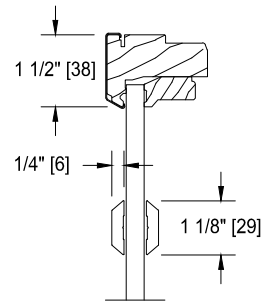

1 1/8" SDL
(PUTTY/PUTTY)

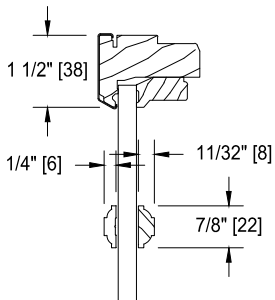

7/8" SDL
(BEAD STOP)

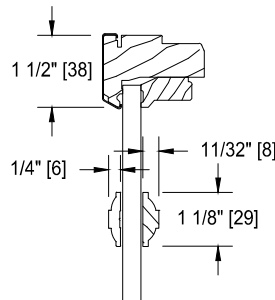

1 1/8" SDL
(BEAD STOP)

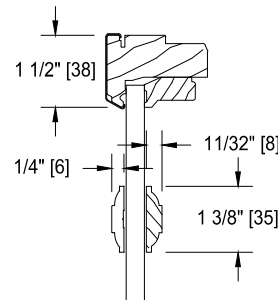

1 3/8" SDL
(BEAD STOP)

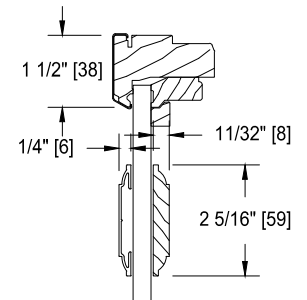

2 5/16" SDL BAR
(BEAD STOP)

**UNIT SIZING, ROUGH OPENINGS &
MASONRY OPENINGS**

GENERAL NOTES:

UNITS WITH NO TRIM AND SILL NOSE:
UNIT SIZE = FRAME SIZE

UNIT SIZE IS ALWAYS THE
EXTREME SIZE OF THE WINDOW
WITH OR WITHOUT TRIM
(DRIP CAP & NAILING FLANGE ARE
NOT ADDED TO ANY UNIT SIZING)

MASONRY OPENING:
MASONRY OPENING IS ALWAYS 1/2" OVER
THE UNIT SIZE OF THE WINDOW

ROUGH OPENING:
ROUGH OPENING IS ALWAYS 3/4" OVER
FRAME SIZE OF THE WINDOW

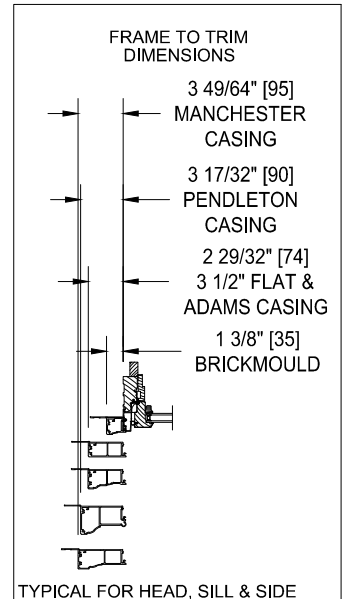
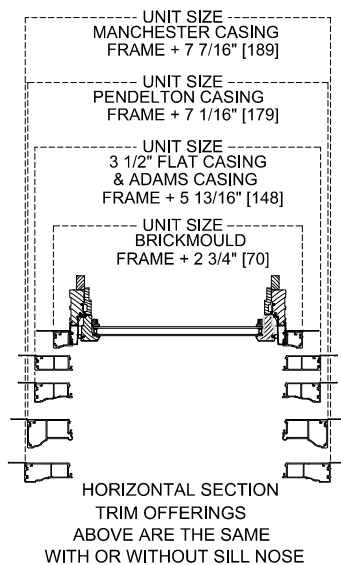
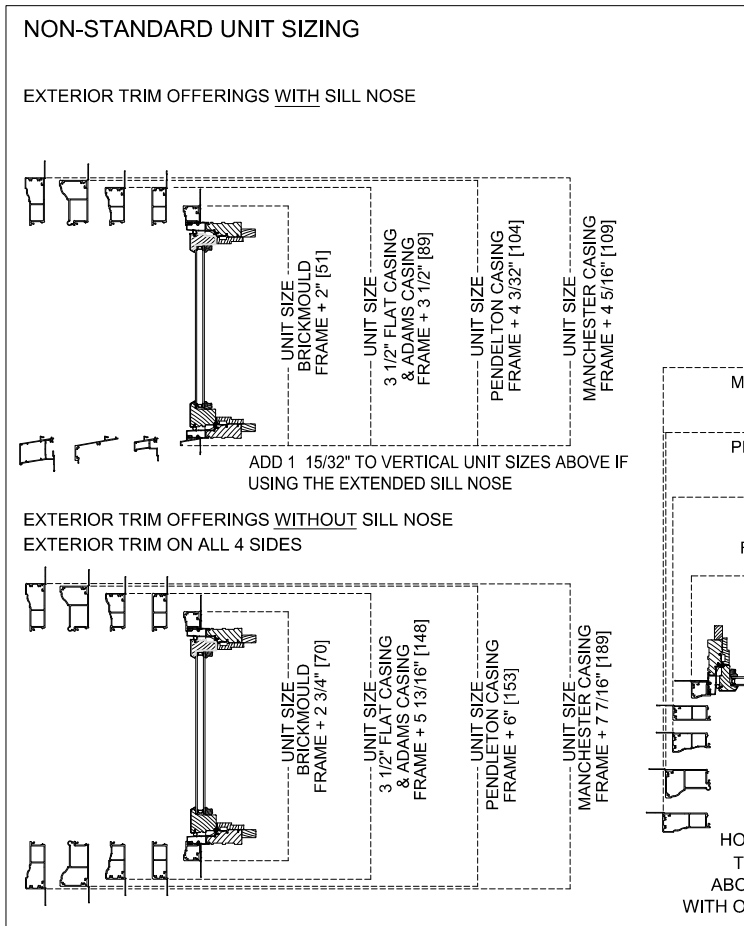
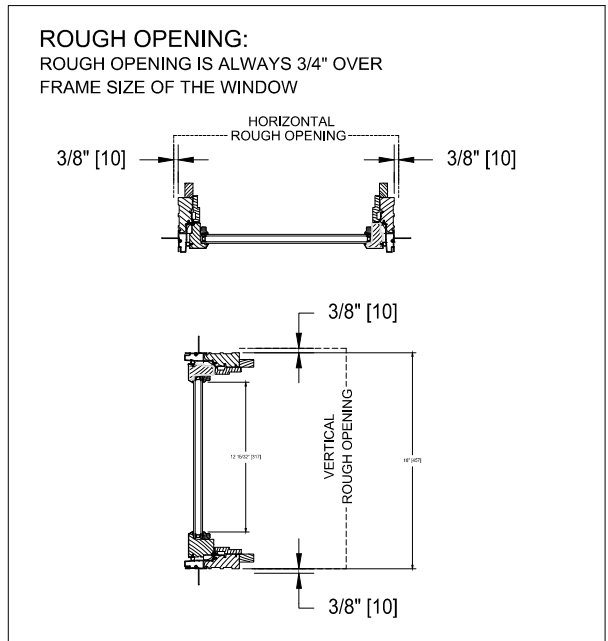
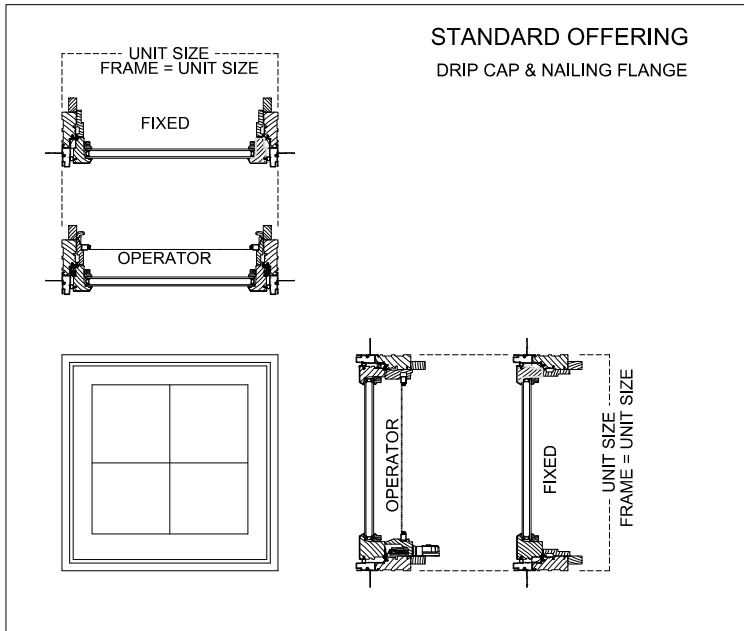

TRIM OPTIONS

EXTERIOR TRIM

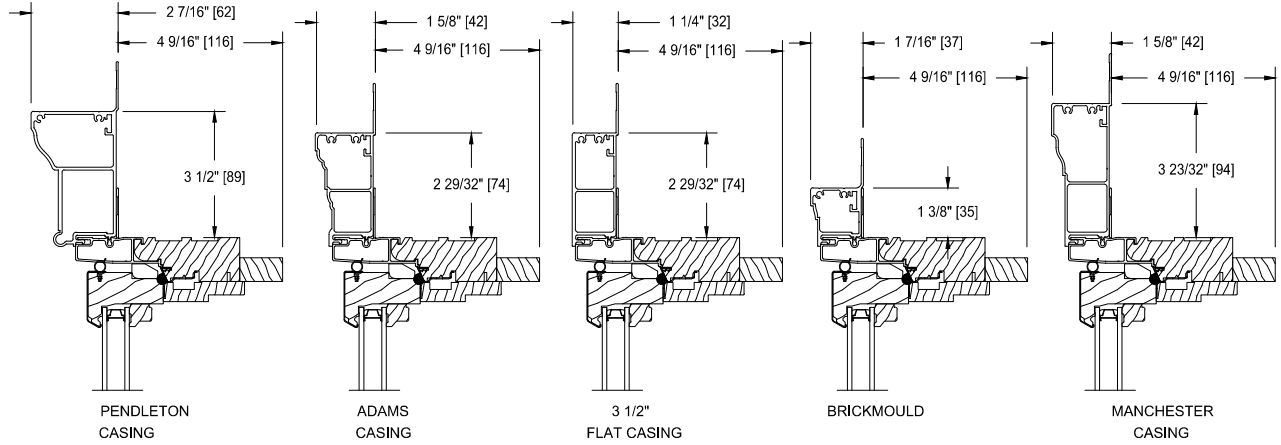

SILL NOSE OPTIONS

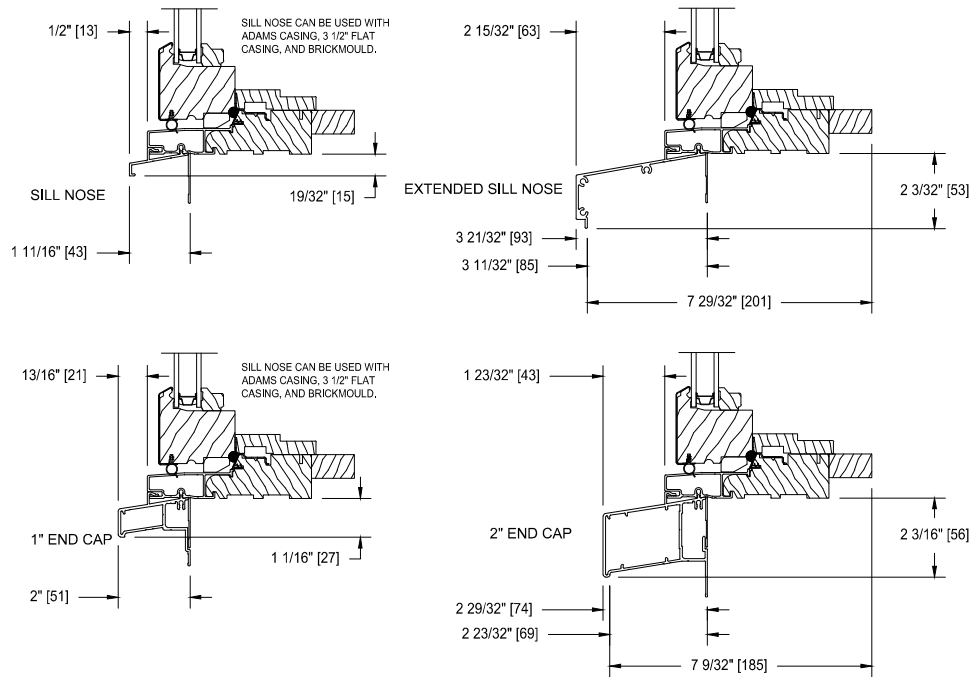

JAMB EXTENDER OPTIONS

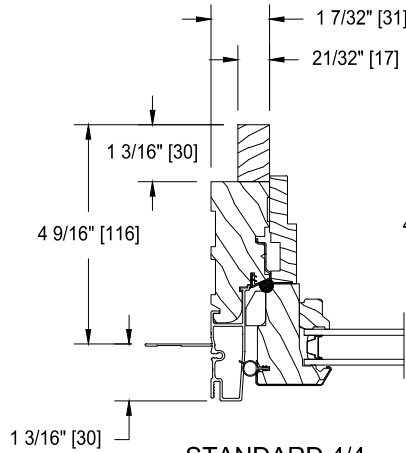

STANDARD 4/4
JAMB EXTENDER

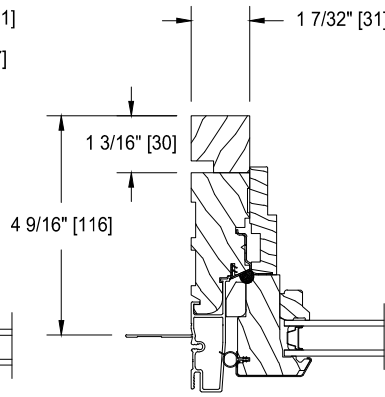

STANDARD 5/4
JAMB EXTENDER

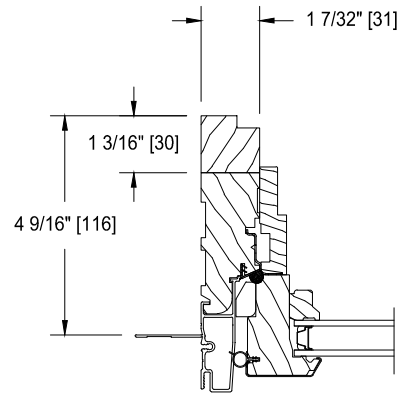

5/4 to 4/4 REVEAL
JAMB EXTENDER

6 9/16" WALL

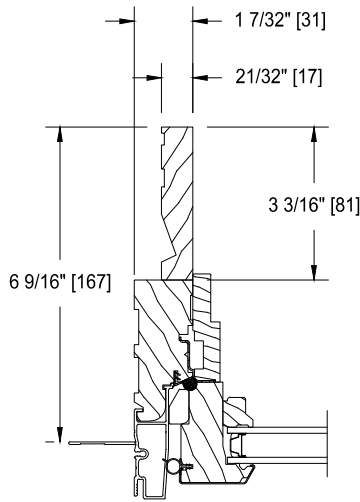

STANDARD 4/4
JAMB EXTENDER

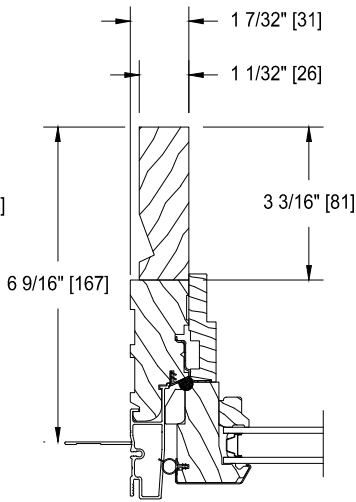

STANDARD 5/4
JAMB EXTENDER

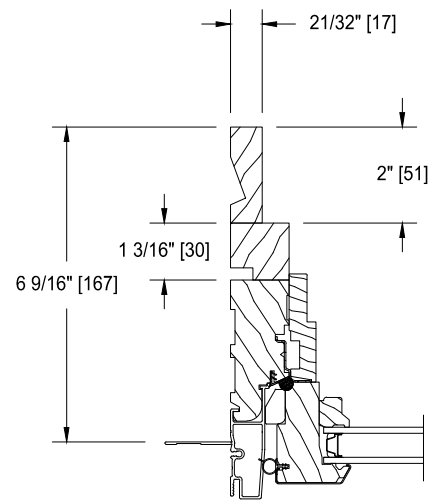

5/4 to 4/4 REVEAL
JAMB EXTENDER

MAXIMUM JAMB WIDTHS

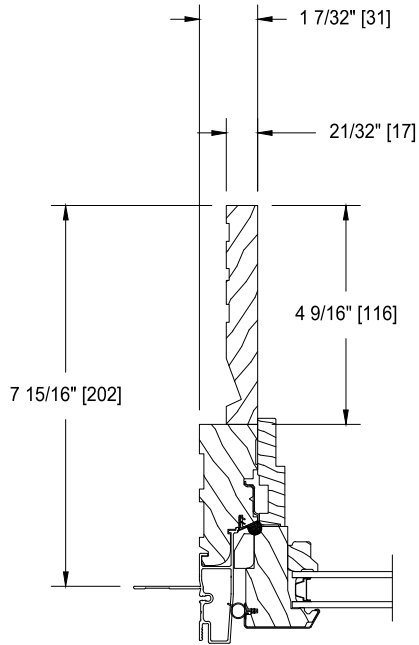

STANDARD 4/4
JAMB EXTENDER

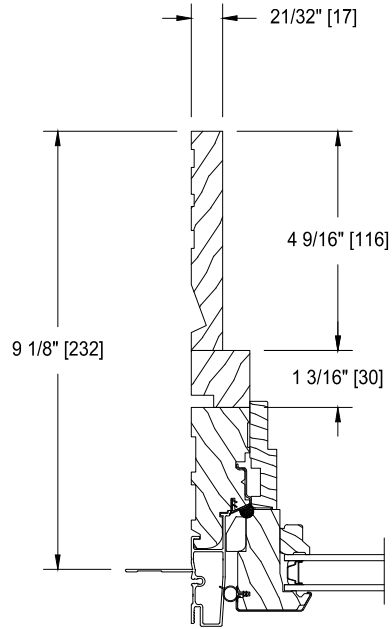

5/4 to 4/4 REVEAL
JAMB EXTENDER

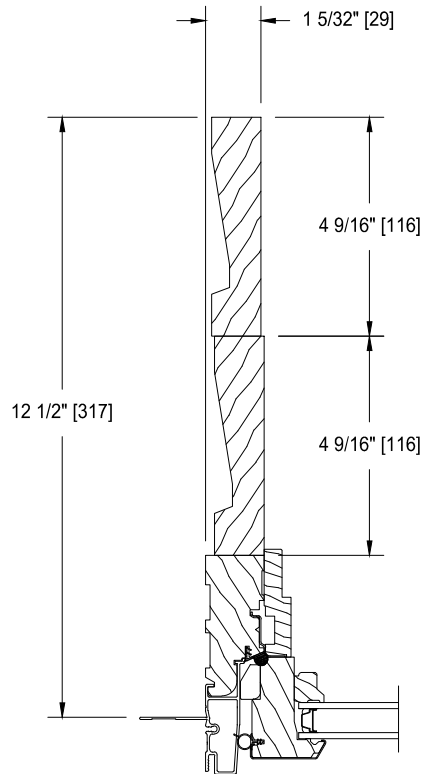

STANDARD 5/4
JAMB EXTENDER

STANDARD MULLION DETAILS

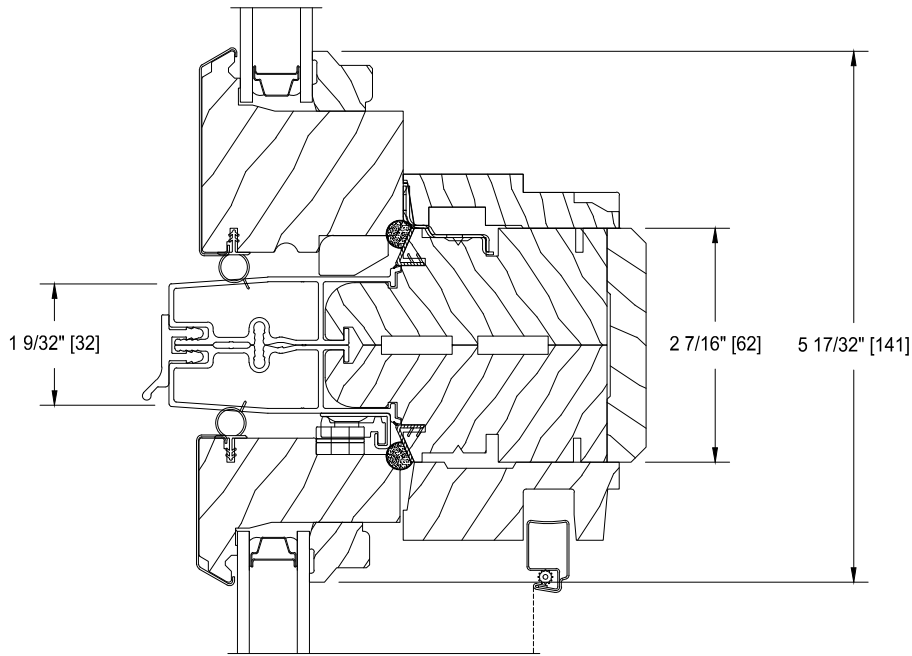

HEAD/SILL

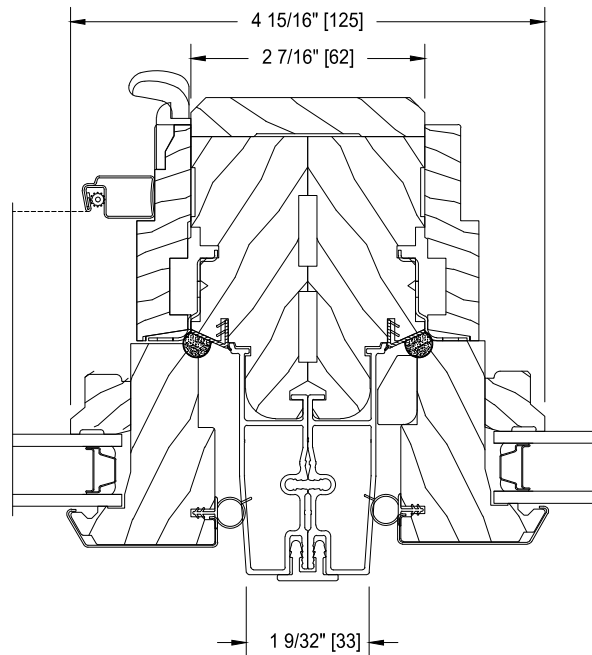

SIDE JAMB

LITE CUT INFORMATION

Clad awning windows are available with removable grilles in 7/8", 1-1/8" and 1-3/8" widths, Airspace (between the panes) grilles, and Simulated Divided Lites. Standard lite cuts are rectangular, and conform to the layouts noted in the charts on the next page. To use the chart, refer to the appropriate table by the type of window and type of bars or grilles the section drawings illustrate. Then simply cross reference the frame Height and Width to determine the standard lite cut.

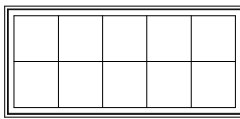

RECTANGULAR

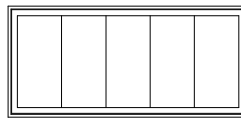

VERTICAL

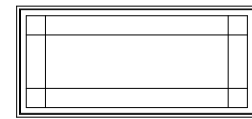

PRAIRIE

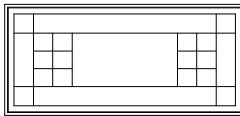

UNEVEN

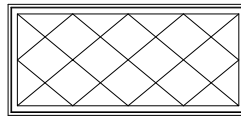

DIAMOND

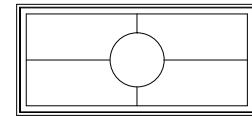

RADIUS

LITE CUT OPTIONS

Special lite cut patterns can include a wide variety of straight line and radius patterns. The illustrations shown here represent just a few of the possibilities. Rectangular, horizontal, vertical and Prairie lite patterns are available in all standard size clad casement windows. Uneven, diamond, radius and Gothic lite cuts are available, subject to approval. Approvals are based on the ability to fulfill the design requirement while maintaining the construction integrity of the finished product.

BAR ALIGNMENT

Alignment of divided lite muntin bars from one window to the next is often required by fine architectural design. Wood grilles, Airspace grilles, and Simulated Divided Lites may be specified with muntin bars aligned.

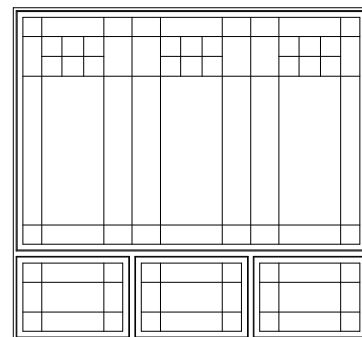

VENT PROJECTIONS

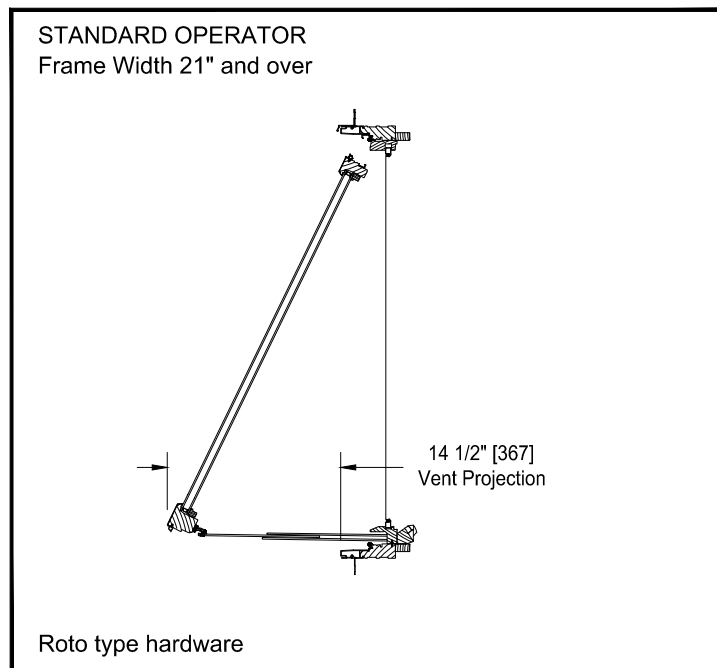
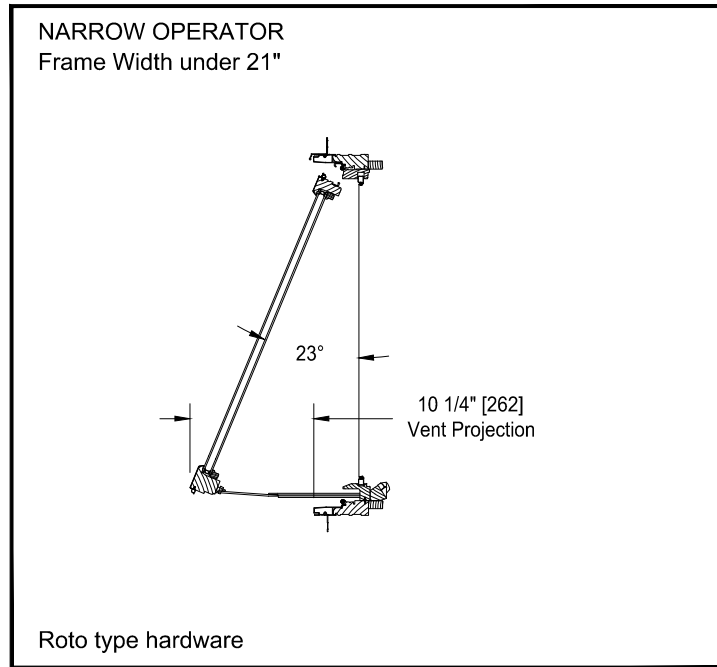

AWNING VENT PROJECTION

The drawings above reflect full operation. Dimensions and angles above are approximate and will vary due to frame height.

**OPERATING UNIT
VERTICAL SECTION**

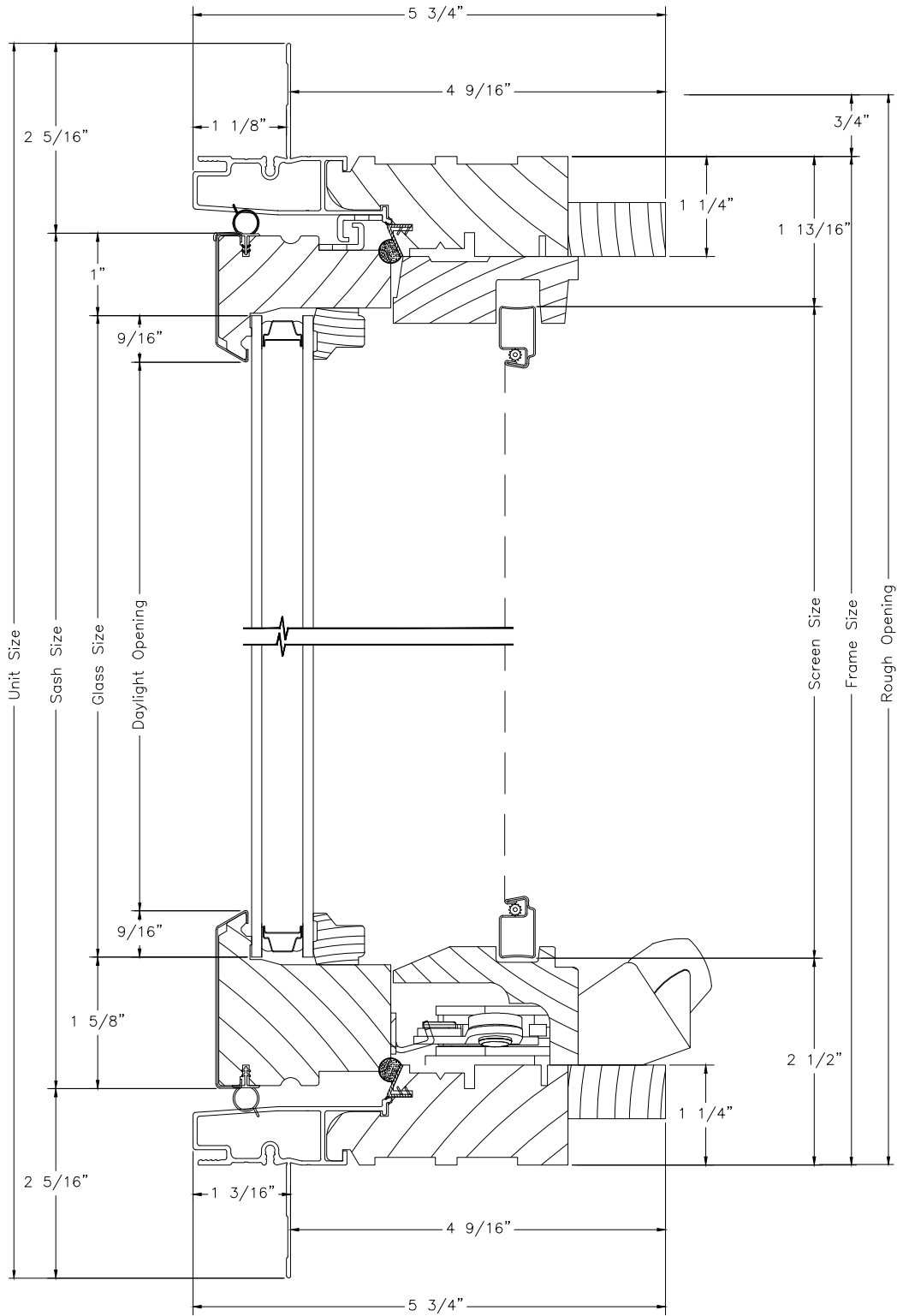

OPERATING UNIT
HORIZONTAL SECTION

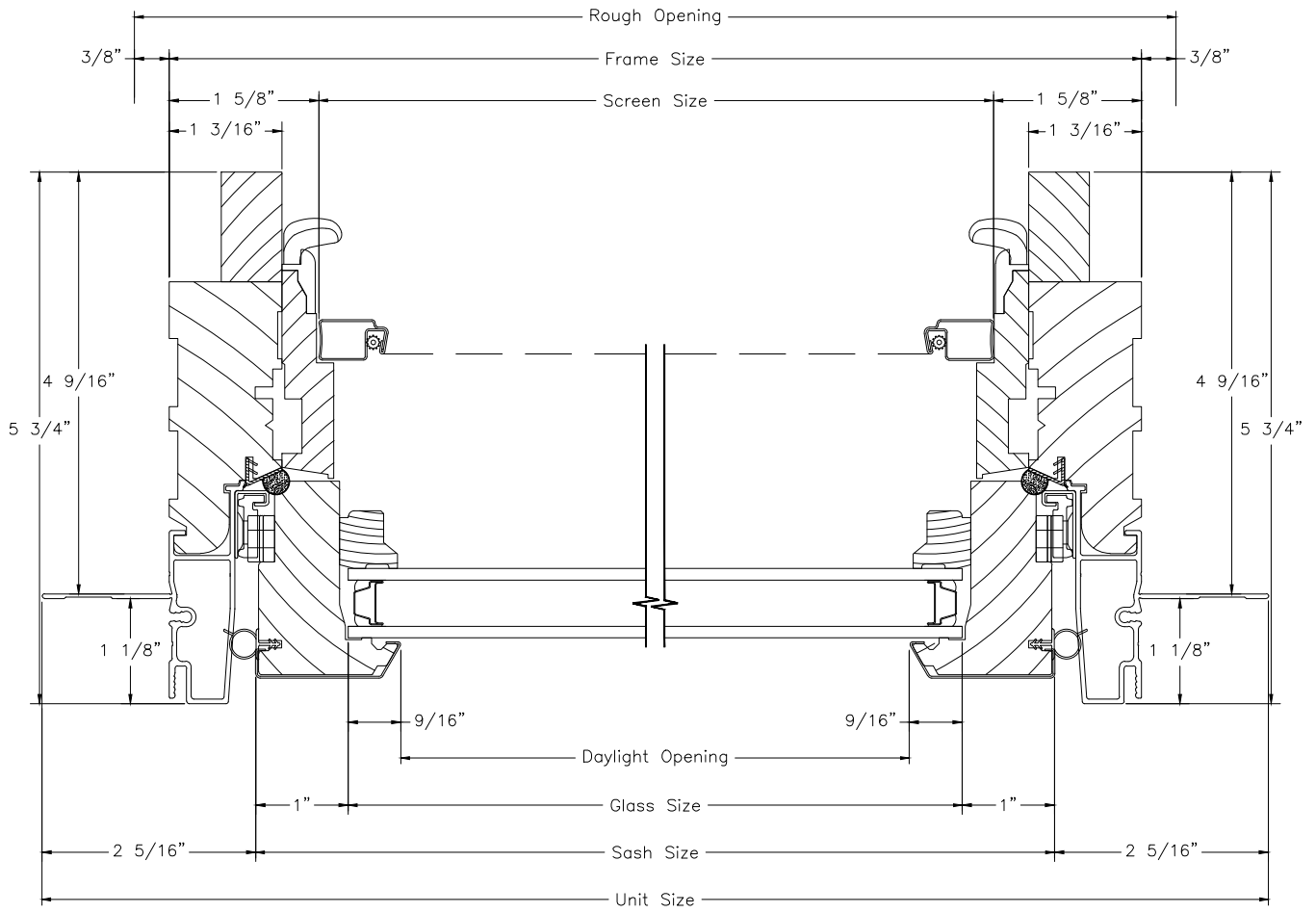

**PICTURE UNIT
VERTICAL SECTION**

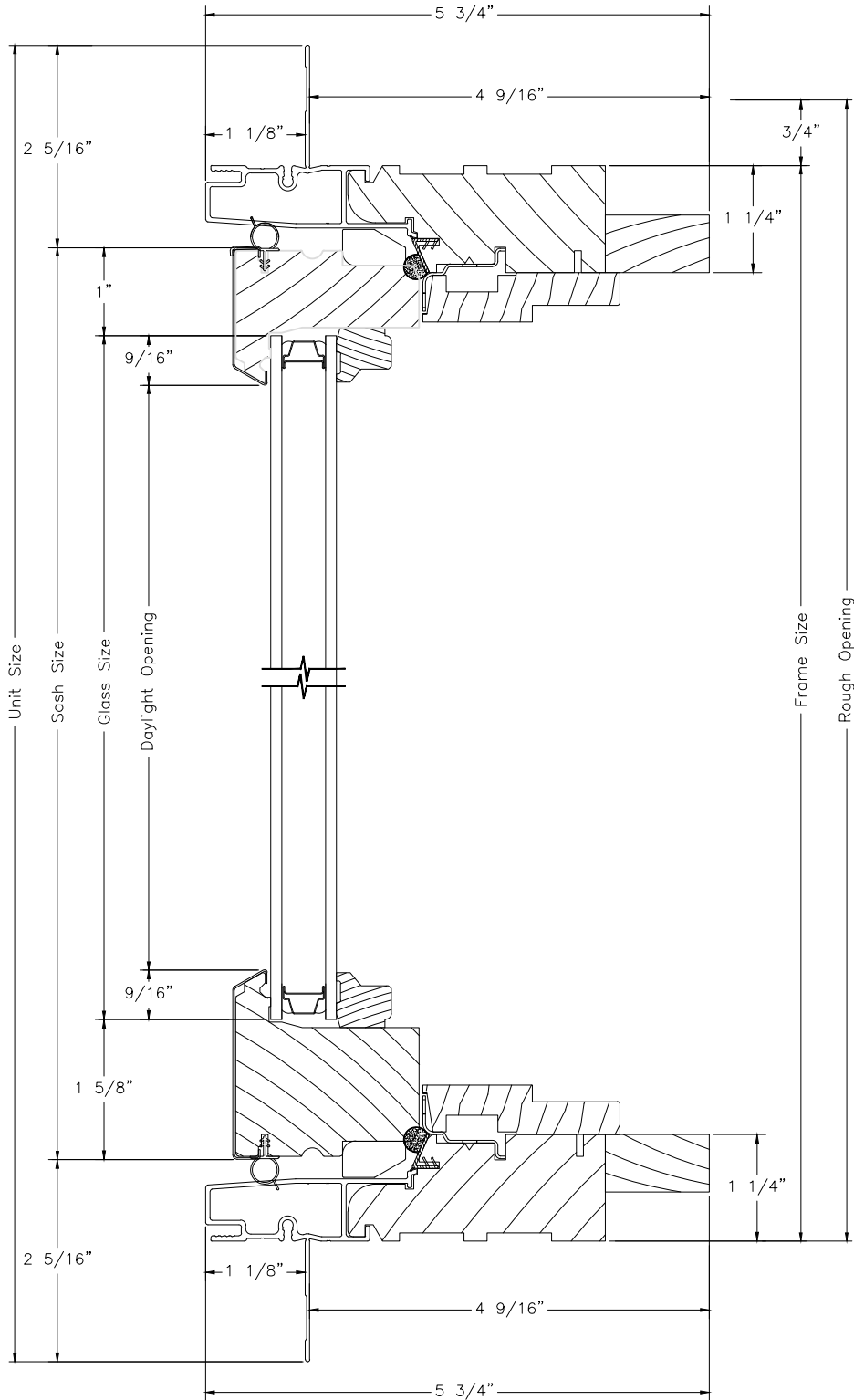

PICTURE UNIT
HORIZONTAL SECTION

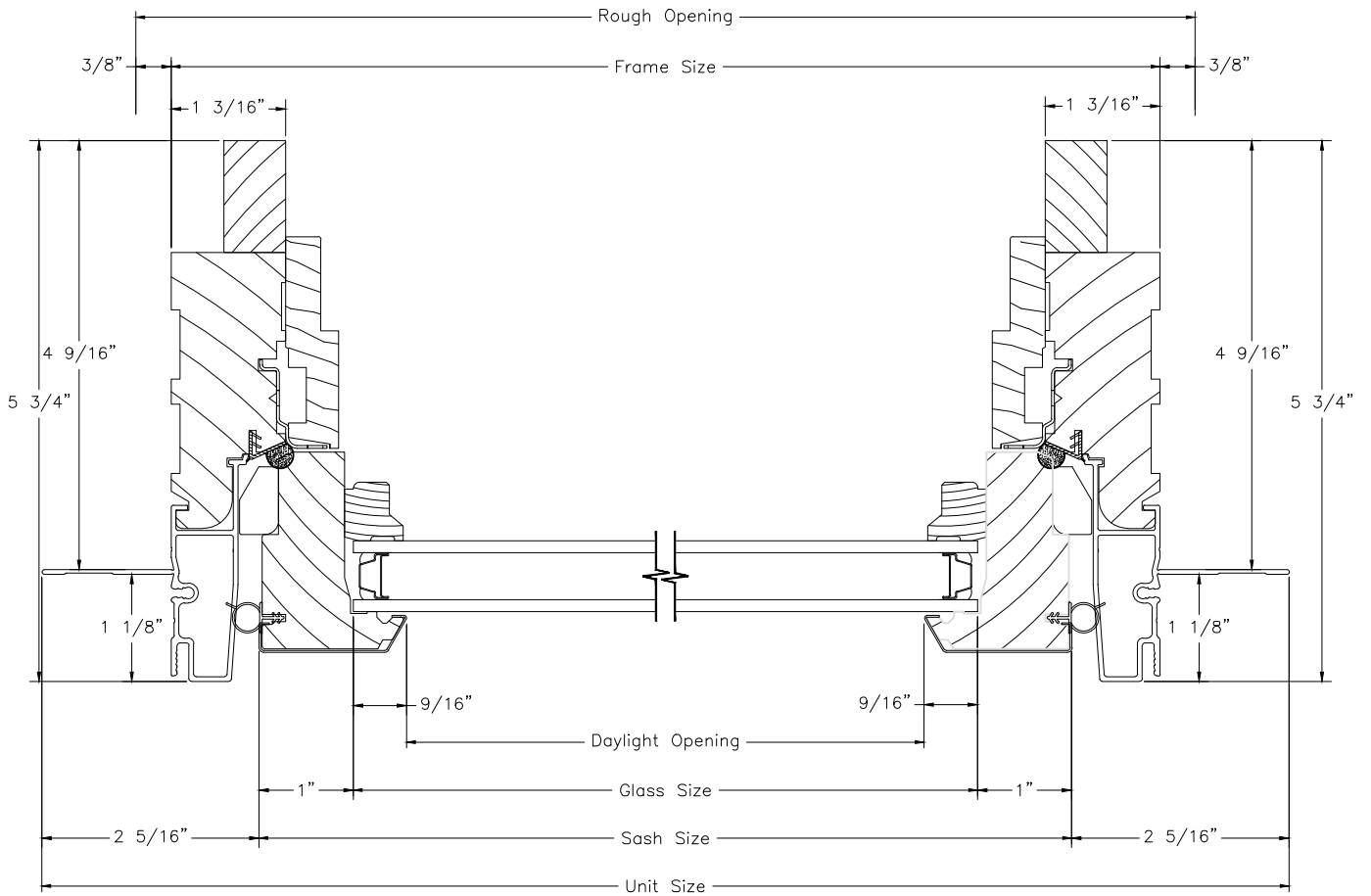

**EXTRUDED SASH IMPACT
OPERATING UNIT
VERTICAL SECTION**

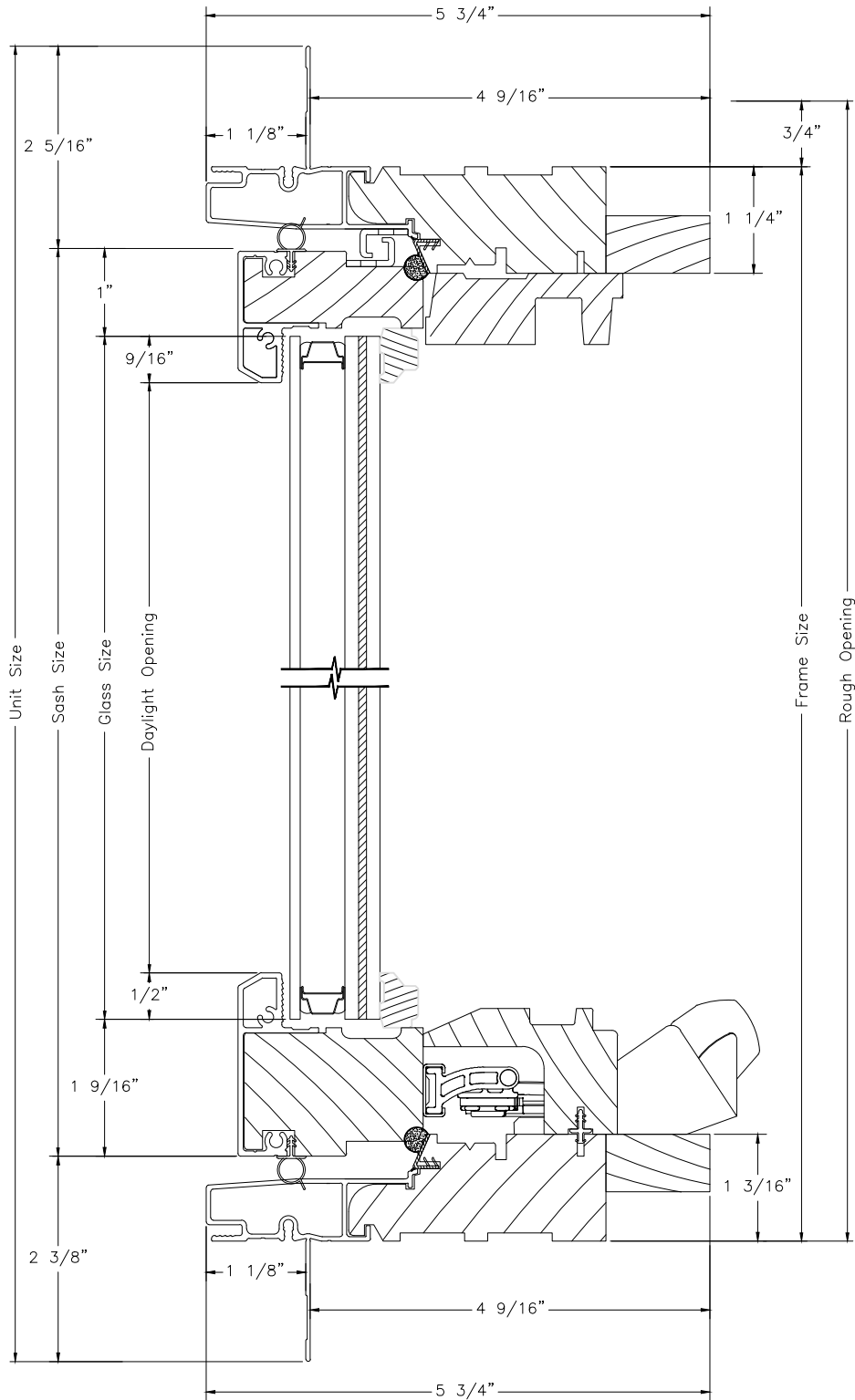

**EXTRUDED SASH IMPACT
OPERATING UNIT
HORIZONTAL SECTION**

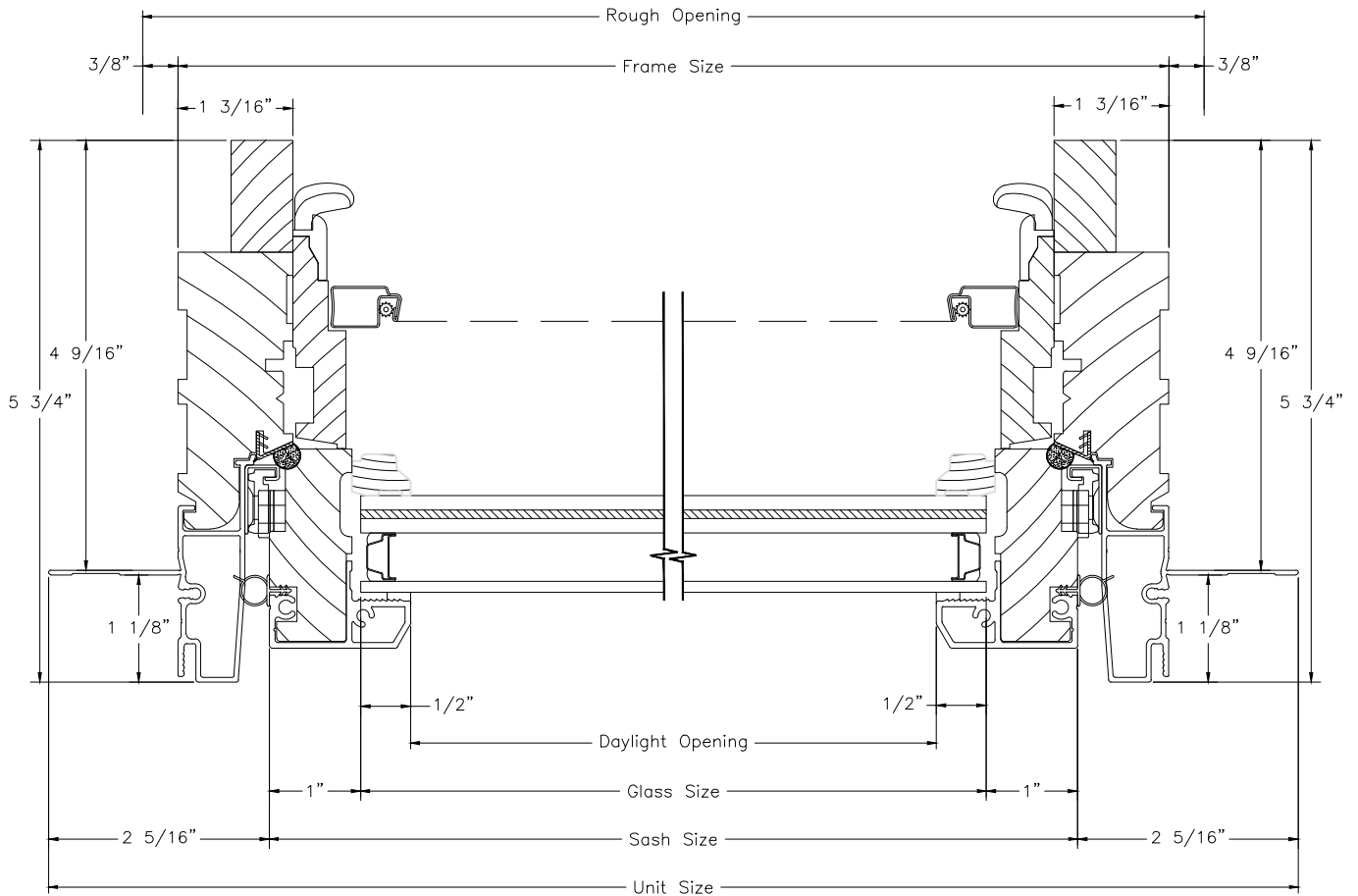

**EXTRUDED SASH IMPACT
STATIONARY UNIT
VERTICAL SECTION**

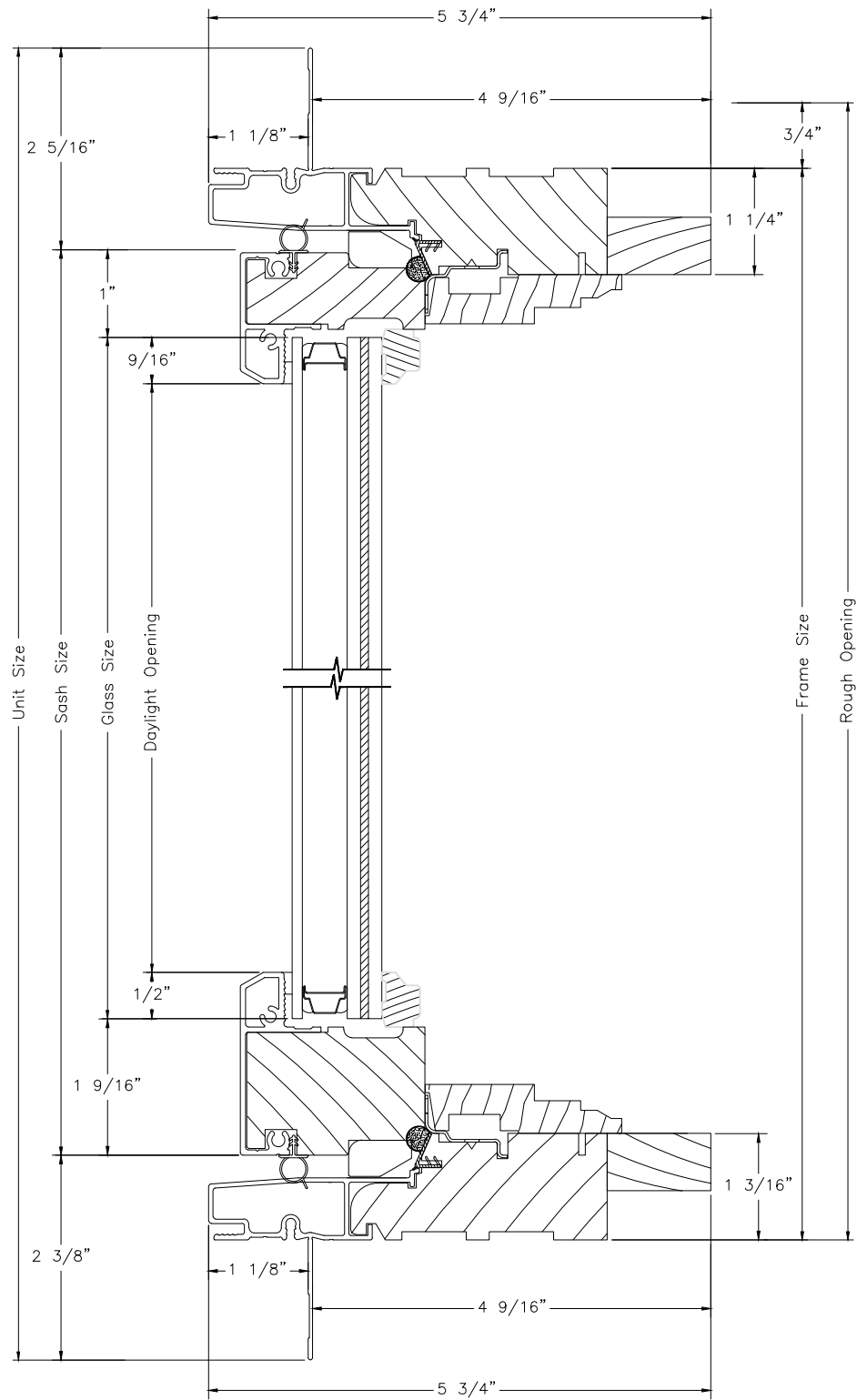

**EXTRUDED SASH IMPACT
STATIONARY UNIT
HORIZONTAL SECTION**

