TABLE OF CONTENTS

Specifications 2-2

Quick Spec Guide 2-3

Elevations/Sizes: 1/4" Scale

 Full Awning Units 2-4

 Awning 2 Wide 2-5

 Awning 3 Wide 2-6

 Awning 1 Wide 2 High (Top Stationary) 2-7

 Awning 2 Wide 2 High (Top Stationary) 2-8

 Awning 3 Wide 2 High (Top Stationary) 2-9

Sash Glazing Options: 4" Scale 2-10

Grilles & SDL Lite Patterns 2-11

Trim Options 2-12

Section Details: 4" Scale 2-13

PRODUCT SPECIFICATIONS

MATERIALS

Extruded vinyl profiles comply with the performance requirements of AAMA 303-97. Colors are White, Desert Sand and Almond.

FRAME

All frames are assembled utilizing fusion-welded technology for added strength and durability. Frame jamb depth is 3-1/4" (83mm) and the exterior wall thickness is 0.065 of an inch. Frames come standard with integral nailing fin that can be easily removed for replacement purposes.

SASH

Sash is 2-1/4" (nominal) or (54.61mm) thick, and is assembled utilizing fusion welded technology for added strength and durability.

GLAZING

3/4" (19mm) insulating glass consists of two lites of glass sealed around a spacer. All insulating glass units comply with the performance requirements of either ASTM E774 or E2190.

GLAZING OPTIONS

3/4" (19mm) insulated glass available in clear, Low-E, tinted, obscure, or other speciality insulating glass as specified. All glass is available tempered. Up to 1-1/8" triple glazing available as an option.

WEATHER STRIPPING

Pile weather-strip applied along full perimeter of operating sash. Single row of nylon encased closed cell foam weather-strip along full perimeter of the frame.

HARDWARE

Awnings utilize scissor hardware with corrosion resistant coating and two-single actuating locks. Color matched lock and operator.

INSECT FRAMES

Optional fiberglass charcoal color insect screen in an aluminum frame to match the color of the unit. Insect screens are intended to allow air and light in and to keep insects out. They are not intended to keep anyone or anything from falling through an open door or window. For safety screens or other security devices contact your local building supply retailer.

GRILLES

SDL (Simulated Divided Lite) - 7/8" (23mm), 1-1/8" (29mm), 1-3/8" (35mm), or 2-1/8" (58mm) contour grilles surface mounted on the exterior surfaces of the insulating glass, with shadow bars mounted between the glass panes suspended within the air cavity.

GBG (Grilles between the Glass) - 5/8" (16mm) flat or 1" (26mm) contour grilles mounted between the glass panes suspended within the air cavity and color matched to the extrusion color.

INSTALLATION

Installation per JELD-WEN Installation Method for Vinyl Windows JII001, JII010 or JII011. See www.jeld-wen.com/resources for instructions.

PERFORMANCE

NFRC Certified - (rated and labeled in accordance with NFRC)

SPECIFICATION	STANDARD FEATURES	OPTIONAL FEATURES Some options may require additional lead times. Consult your JELD-WEN Sales Representative
COLOR	<ul style="list-style-type: none"> White 	<ul style="list-style-type: none"> Desert Sand Almond
SIZE	<ul style="list-style-type: none"> Width: 18" to 48" Height: 18" to 36" 	
FRAME	<ul style="list-style-type: none"> Integral Nail Fin 	<ul style="list-style-type: none"> Snap-on Flush Fin Snap-on Flat Casing Snap-on Brickmould
GLAZING	<ul style="list-style-type: none"> Insulating Clear 	<ul style="list-style-type: none"> Low-E Obscure Bronze Gray Gluechip Rain Azurlite Laminated All glass available tempered <p><i>regional glass availabilities may differ</i></p>
HARDWARE	<ul style="list-style-type: none"> Regular Crank Handle E-Guard™ hardware 	<ul style="list-style-type: none"> Maximum Opening Hardware Coastal Package (regionally available)
HARDWARE COLOR	<ul style="list-style-type: none"> Color Matched to extrusion 	<ul style="list-style-type: none"> Chestnut Bronze Bright Brass Antique Brass Brushed Chrome
SCREENS SCREEN FRAME COLOR	<ul style="list-style-type: none"> Fiberglass Color Matched to extrusion 	
GRILLES		<ul style="list-style-type: none"> 1" Contour GBG (grilles between the glass) 5/8" Flat GBG (grilles between the glass) 7/8", 1-1/8", 1-3/8", 2-1/8" SDL (simulated divided lite) profiles
JAMB DEPTH	<ul style="list-style-type: none"> 3-1/4" 	

SINGLE WIDE ELEVATIONS

	25 3/4"(654)	29 3/4"(756)	31 3/4"(806)	37 3/4"(959)	43 3/4"(1111)	49 3/4"(1264)
UNIT SIZE	24"(610)	28"(711)	30"(762)	36"(914)	42"(1067)	48"(1219)
ROUGH OPENING	23 1/2"(597)	27 1/2"(699)	29 1/2"(749)	35 1/2"(902)	41 1/2"(1054)	47 1/2"(1207)
FRAME SIZE	17 1/8"(435)	21 1/8"(537)	23 1/8"(588)	29 1/8"(740)	35 1/8"(893)	41 1/8"(1045)
DAYLIGHT OPENING	18 3/4"(502) 18"(457) 17 1/2"(445) 11 1/8"(283)					
	VAWN2418	VAWN2818	VAWN3018	VAWN3618	VAWN4218	VAWN4818
	25 3/4"(654) 24"(610) 23 1/2"(597) 17 1/8"(435)					
	VAWN2424	VAWN2824	VAWN3024	VAWN3624	VAWN4224	VAWN4824
	31 3/4"(806) 30"(762) 29 1/2"(749) 23 1/8"(588)					
	VAWN2430	VAWN2830	VAWN3030	VAWN3630	VAWN4230	VAWN4830
	37 3/4"(959) 36"(914) 35 1/2"(902) 29 1/8"(740)					
	VAWN2436	VAWN2836	VAWN3036	VAWN3636	VAWN4236	VAWN4836

ELEVATION SYMBOL LEGEND:

NUMBER INDICATES DESIGN PRESSURE (DP) RATING WITH STANDARD GLAZING

2 WIDE ELEVATIONS

UNIT SIZE	49 3/4"(1264)	57 3/4"(1460)	61 3/4"(1568)	73 3/4"(1873)	85 3/4"(2178)	97 3/4"(2483)
ROUGH OPENING	48"(1219)	56"(1422)	60"(1524)	72"(1829)	84"(2134)	96"(2438)
FRAME SIZE	47 1/2"(1207)	55 1/2"(1410)	59 1/2"(1511)	71 1/2"(1861)	83 1/2"(2121)	95 1/2"(2426)
DAYLIGHT OPENING	17 1/8"(435)[2]	21 1/8"(537)[2]	23 1/8"(588)[2]	29 1/8"(740)[2]	35 1/8"(893)[2]	41 1/8"(1045)[2]
19 3/4"(502)						
18"(457)	VMAWN4818	VMAWN5618	VMAWN6018	VMAWN7218-2	VMAWN8418	VMAWN9618
25 3/4"(654)						
24"(610)	VMAWN4824	VMAWN5624	VMAWN6024	VMAWN7224-2	VMAWN8424	VMAWN9624
23 1/2"(597)						
17 1/2"(446)	VMAWN4830	VMAWN5630	VMAWN6030	VMAWN7230	VMAWN8430	VMAWN9630
23 1/8"(588)						
31 3/4"(806)	VMAWN4836	VMAWN5636	VMAWN6036	VMAWN7236	VMAWN8436	VMAWN9636
30"(762)						
29 1/2"(749)	VMAWN4836	VMAWN5636	VMAWN6036	VMAWN7236	VMAWN8436	VMAWN9636
37 3/4"(959)						
36"(914)	VMAWN4836	VMAWN5636	VMAWN6036	VMAWN7236	VMAWN8436	VMAWN9636
35 1/2"(902)						
29 1/8"(740)	VMAWN4836	VMAWN5636	VMAWN6036	VMAWN7236	VMAWN8436	VMAWN9636

3 WIDE ELEVATIONS

UNIT SIZE	73 3/4"(1873)	85 3/4"(2178)	91 3/4"(2330)	109 3/4"(2788)	127 3/4"(3245)
ROUGH OPENING	72"(1829)	84"(2134)	90"(2286)	108"(2743)	126"(3200)
FRAME SIZE	71 1/2"(1861)	83 1/2"(2121)	89 1/2"(2273)	107 1/2"(2731)	125 1/2"(3188)
DAYLIGHT OPENING	17 1/8"(435)[3]	21 1/8"(537)[3]	23 1/8"(589)[3]	29 1/8"(740)[3]	35 1/8"(893)[3]
19 3/4"(502)					
25 3/4"(654)					
31 3/4"(806)					

UNIT SIZE	145 3/4"(3702)
ROUGH OPENING	144"(3658)
FRAME SIZE	143 1/2"(3645)
DAYLIGHT OPENING	41 1/8"(1045)[3]
19 3/4"(502)	
25 3/4"(654)	
31 3/4"(806)	





1 WIDE, 2 HIGH ELEVATIONS

	25 3/4"(654)	29 3/4"(756)	31 3/4"(806)	37 3/4"(959)	43 3/4"(1111)	49 3/4"(1264)
UNIT SIZE	25 3/4"(654)	29 3/4"(756)	31 3/4"(806)	37 3/4"(959)	43 3/4"(1111)	49 3/4"(1264)
ROUGH OPENING	24"(610)	28"(711)	30"(762)	36"(914)	42"(1067)	48"(1219)
FRAME SIZE	23 1/2"(597)	27 1/2"(699)	29 1/2"(749)	35 1/2"(902)	41 1/2"(1054)	47 1/2"(1207)
DAYLIGHT OPENING	17 1/8"(435)	21 1/8"(537)	23 1/8"(588)	29 1/8"(740)	35 1/8"(893)	41 1/8"(1045)
37 3/4"(959) 36"(914) 35 1/2"(902) 11 1/8"(283) 2						
	VMAWN2436	VMAWN2836	VMAWN3036	VMAWN3636	VMAWN4236	VMAWN4836
49 3/4"(1264) 48"(1219) 47 1/2"(1207) 17 1/8"(435) 2						
	VMAWN2448	VMAWN2848	VMAWN3048	VMAWN3648	VMAWN4248	VMAWN4848
61 3/4"(1568) 60"(1524) 59 1/2"(1511) 23 1/8"(588) 2						
	VMAWN2460	VMAWN2860	VMAWN3060	VMAWN3660	VMAWN4260	VMAWN4860

2 WIDE 2 HIGH ELEVATIONS

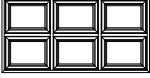
UNIT SIZE	49 3/4"(1264)	57 3/4"(1460)	61 3/4"(1568)	73 3/4"(1873)	85 3/4"(2178)	97 3/4"(2483)
ROUGH OPENING	48"(1219)	56"(1422)	60"(1524)	72"(1829)	84"(2134)	96"(2438)
FRAME SIZE	47 1/2"(1207)	55 1/2"(1410)	59 1/2"(1511)	71 1/2"(1861)	83 1/2"(2121)	95 1/2"(2426)
DAYLIGHT OPENING	17 1/8"(435)[2]	21 1/8"(537)[2]	23 1/8"(588)[2]	29 1/8"(740)[2]	35 1/8"(893)[2]	41 1/8"(1045)[2]
	37 3/4"(959) 36"(914) 35 1/2"(902) 11 1/8"(283)[2]					
	VMAWN4836	VMAWN5636	VMAWN6036	VMAWN7236	VMAWN8436	VMAWN9636
	49 3/4"(1264) 48"(1219) 47 1/2"(1207) 17 1/8"(435)[2]					
	VMAWN4848	VMAWN5648	VMAWN6048	VMAWN7248	VMAWN8448	VMAWN9648
	61 3/4"(1568) 60"(1524) 59 1/2"(1511) 23 1/8"(588)[2]					
	VMAWN4860	VMAWN5660	VMAWN6060	VMAWN7260	VMAWN8460	VMAWN9660

3 WIDE, 2 HIGH ELEVATIONS

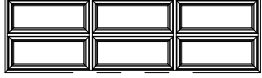
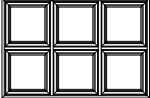
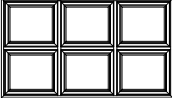
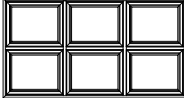
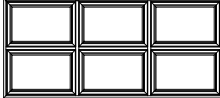
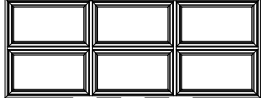
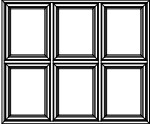
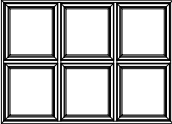
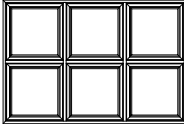
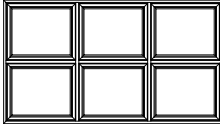
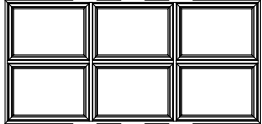
UNIT SIZE	73 3/4"(1873)	85 3/4"(2178)	91 3/4"(2330)	109 3/4"(2788)	127 3/4"(3245)
ROUGH OPENING	72"(1829)	84"(2134)	90"(2286)	108"(2743)	126"(3200)
FRAME SIZE	71 1/2"(1861)	83 1/2"(2121)	89 1/2"(2273)	107 1/2"(2731)	125 1/2"(3188)
DAYLIGHT OPENING	17 1/8"(435)[3]	21 1/8"(537)[3]	23 1/8"(578)[3]	29 1/8"(740)[3]	35 1/8"(893)[3]
37 3/4"(959) 36"(914) 35 1/2"(902) 11 1/8"(283)[2]	 VMAWN7236	 VMAWN8436	 VMAWN9036	 VMAWN10836	 VMAWN12636
49 3/4"(1264) 48"(1219) 47 1/2"(1207) 17 1/8"(435)[2]	 VMAWN7248	 VMAWN8448	 VMAWN9048	 VMAWN10848	 VMAWN12648
61 3/4"(1568) 60"(1523) 59 1/2"(1511) 23 1/8"(588)[2]	 VMAWN7260	 VMAWN8460	 VMAWN9060	 VMAWN10860	 VMAWN12660

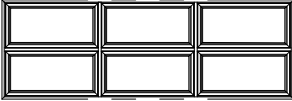
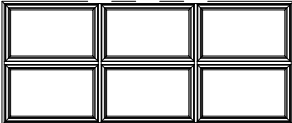
UNIT SIZE	145 3/4"(3702)
ROUGH OPENING	144"(3658)
FRAME SIZE	143 1/2"(3645)
DAYLIGHT OPENING	41 1/8"(1045)[3]
37 3/4"(959) 36"(914) 35 1/2"(902) 11 1/8"(283)[2]	 VMAWN14436
49 3/4"(1264) 48"(1219) 47 1/2"(1207) 17 1/8"(435)[2]	 VMAWN14448
61 3/4"(1568) 60"(1523) 59 1/2"(1511) 23 1/8"(588)[2]	 VMAWN14460

SASH GLAZING OPTIONS

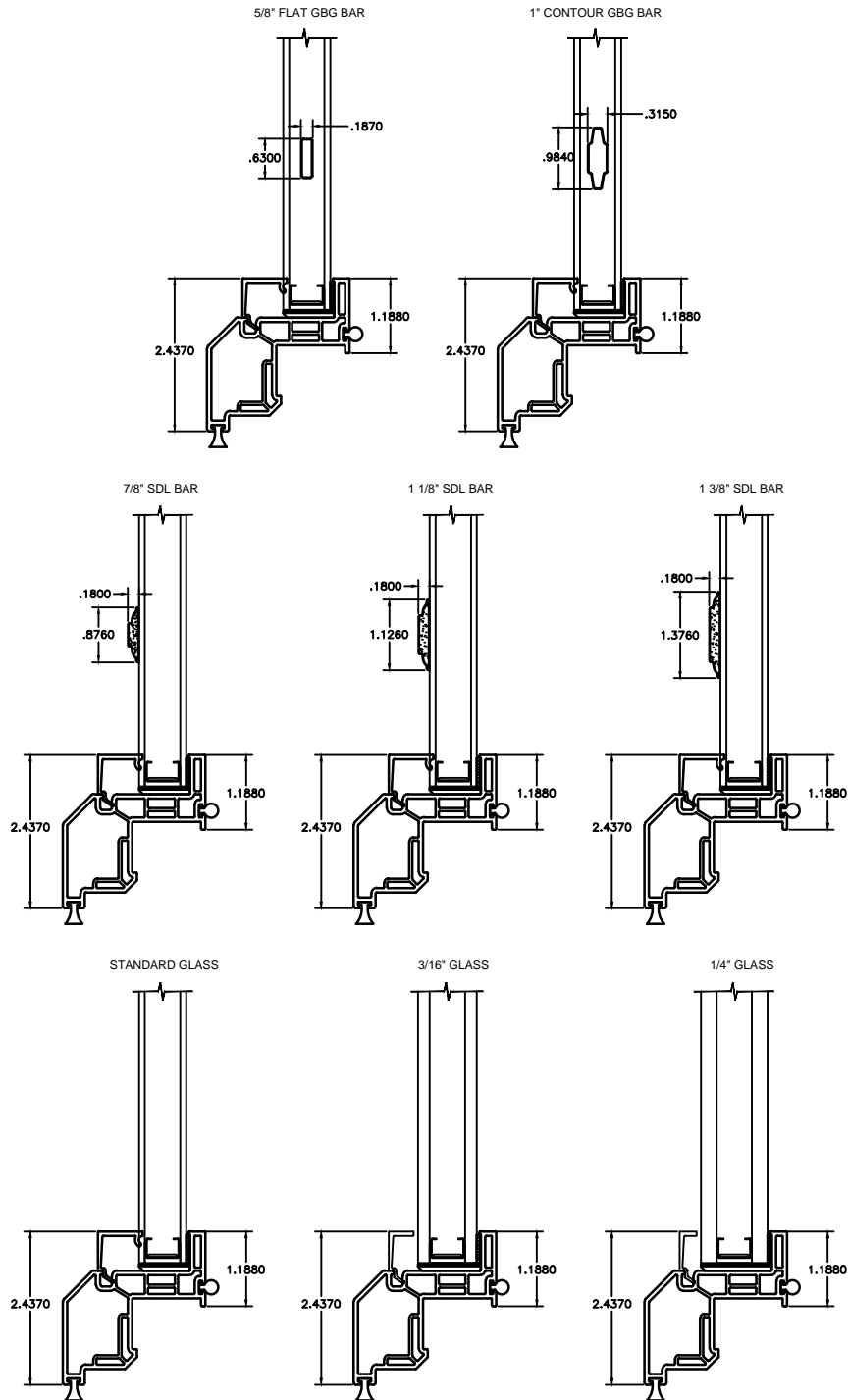

GRILLES & SDL LITE PATTERNS

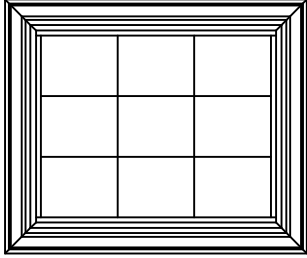

STANDARD

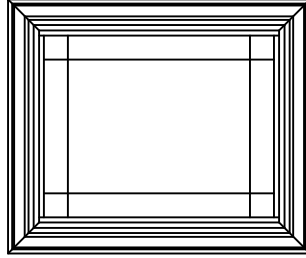

PRAIRIE

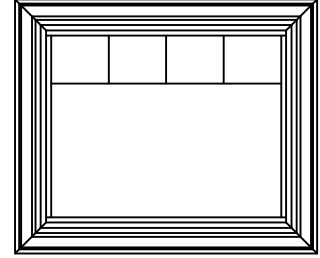

COLONIAL TOP 1/2

TRIM OPTIONS

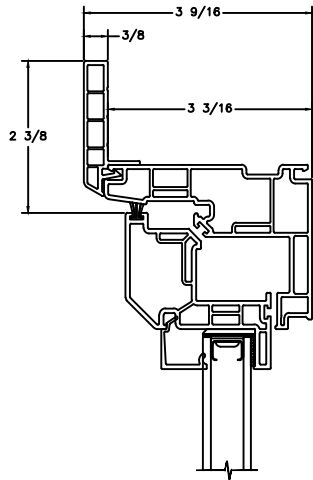

1 5/8" FLUSH FIN

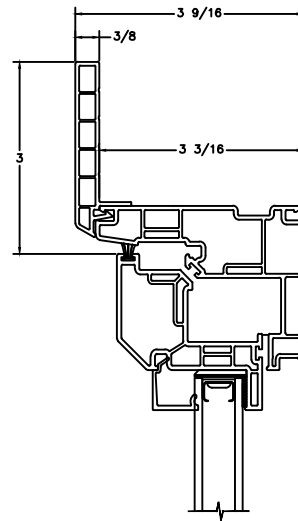

2 1/8" FLUSH FIN

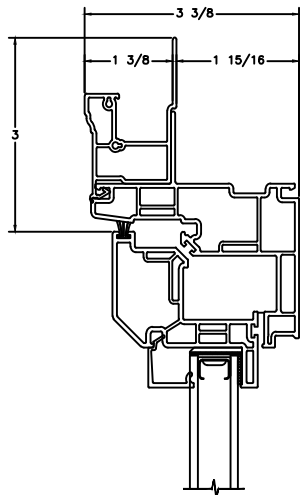

BRICKMOULD

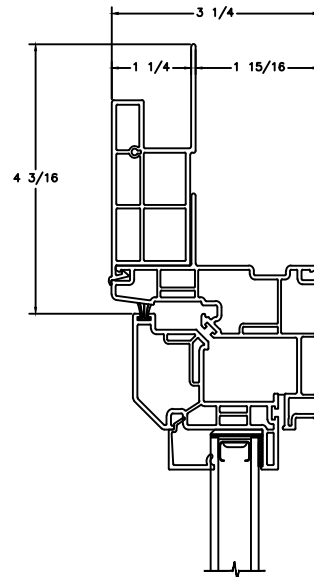

FLAT CASING

VERTICAL SECTION

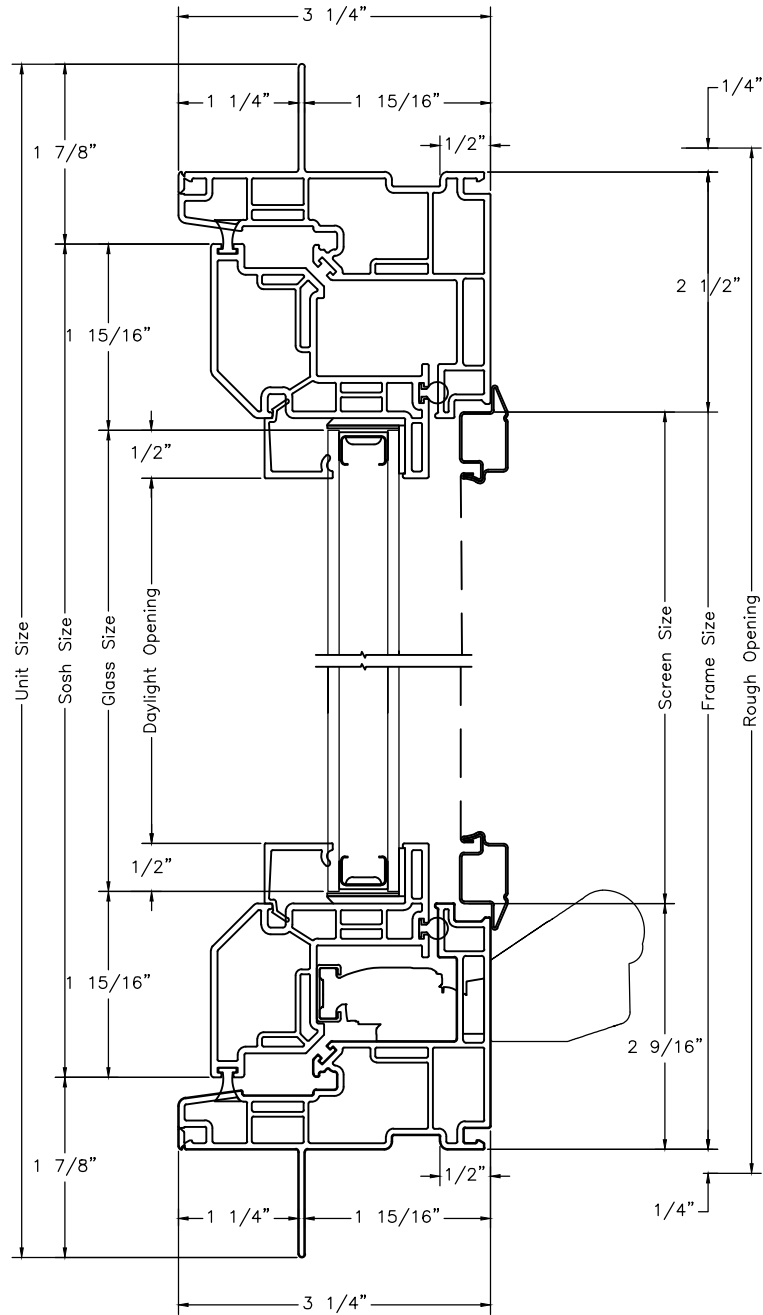

HORIZONTAL SECTION

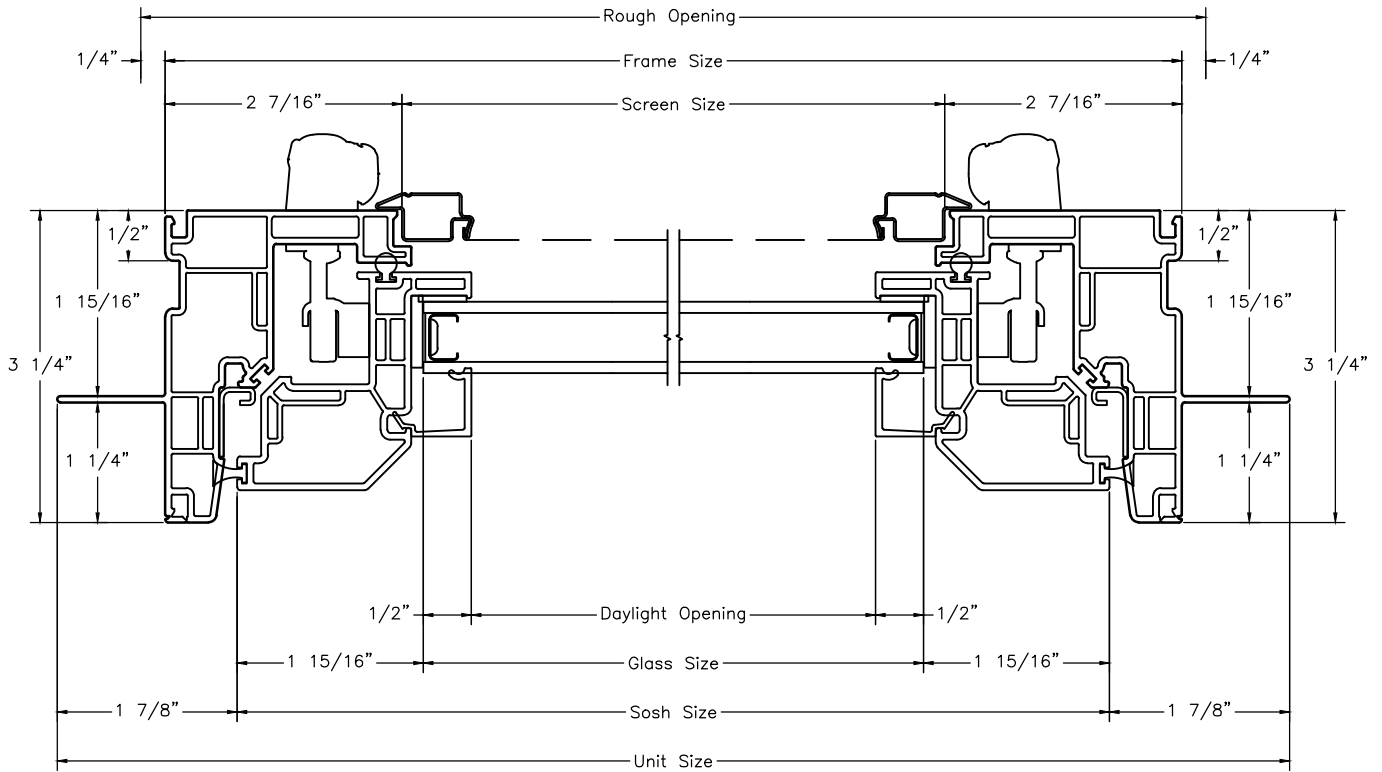

HORIZONTAL TWIN SECTION

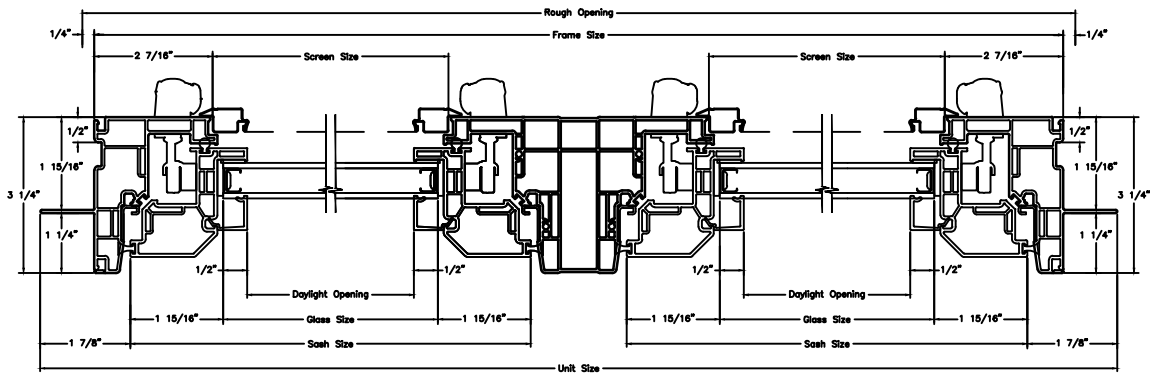

3 WIDE HORIZONTAL SECTION

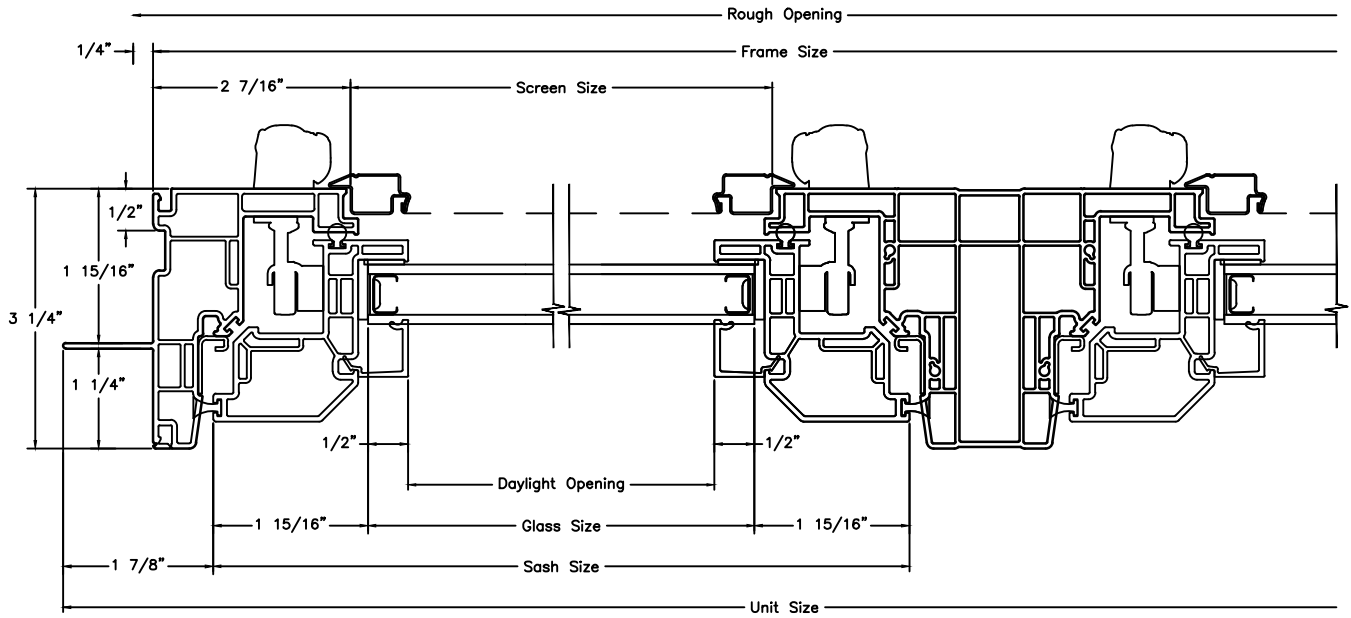

VERTICAL SECTION WITH TRANSOM

