

---

TABLE OF CONTENTS

---

Specifications .....	7-2
Quick Spec Guide .....	7-3
Elevations/Sizes: 1/4" Scale	
2-Panel .....	7-4
3-Panel .....	7-5
2-Panel with Transom .....	7-6
Sidelite .....	7-8
Transom .....	7-9
3-Panel Transom .....	7-10
Grille Patterns .....	7-11
Section Details: 6" Scale .....	7-12

---

**PRODUCT SPECIFICATIONS**

---

**MATERIALS**

The extruded vinyl profiles comply with the performance requirements of AAMA 303-97. The colors extend through the profile of the extrusion with White and Desert Sand colors available. An Almond color is available in select Western markets.

**FRAME**

All frames and sash are assembled using fusion-welding technology for added strength and durability. The frame jamb width is 4-3/8" (111mm), and the nominal extrusion exterior wall thickness is 0.080". The wall depth of the sliding patio door product is 3-3/16". The frame incorporates an integral nailing fin which can be easily removed to allow the unit to be used in a replacement door application. Weep holes are included on the frame to ensure standing water is directed to the exterior plane of the unit. An interior and exterior accessory groove is standard to accommodate various frame accessory and assembly options on the product. The sliding patio door incorporates an extruded screen track on the exterior of the product. An optional snap-in brickmould with integral j-channel and snap-in flat casing profiles are available for select Eastern markets. An optional stucco key and dual-wall flush fin profiles are available for specific applications in select Western markets.

**PANEL**

The sliding patio door panel is a 1-13/16" (45.72mm) nominal thickness, and is assembled using fusion-welding technology for added strength and durability. The sliding panel also uses a steel reinforcement bar in the vertical stiles and in the vertical meeting interlock of the fixed panel. The fixed panel glass is direct-set into the unit frame. The sliding patio doors are available in a left or right hand configuration.

**GLAZING**

3/4" (19mm) insulated glass consist of two tempered lites of glass sealed around a spacer. The tempered glass is mounted into the panel using a silicone-glazing compound. The insulating glass units comply with the performance requirements of the IGCC in accordance with either ASTM E774 or E2190. All units are exterior glazed.

**GLAZING OPTIONS**

3/4" (19mm) tempered insulated glass is available in clear, Low-E or Low-E 366, tinted, obscure or other specialty insulating glass as specified. A V-groove option is available in select markets.

**WEATHER-STRIPPING**

A fin-pile weather-strip is applied along perimeter face of the operating panel. The meeting stiles utilize an integral extruded interlock to provide exceptional performance.

**HARDWARE**

The color matched handle-set with a heavy duty lock is standard. The sliding patio door is available with an optional keyed cylinder lock. Locks can be keyed the same or differently. The interior handle is a contemporary D handle while the exterior handle is a low profile handle design. The sliding panel is equipped with heavy duty, end-adjustable metal rollers that glide effortlessly on a stainless steel panel track. Frame panel bumpers designed to limit the panel travel are included for mounting on the fixed panel frame.

**INSECT SCREENS**

The optional fiberglass charcoal color insect screen is set in an aluminum frame to match the color of the unit. The exterior rolling screen includes a screen latch and strike and is adjustable. Insect screens are intended to allow air and light in and to keep insects out. They are not intended to keep anyone or anything from falling through an open door or window. For safety screens or other security devices contact your local building supply retailer.

**GRILLES**

**GBG** (Grilles between the Glass) - 5/8" (16mm) and 7/8" (22.2mm) flat or 1" (26mm) contour grilles mounted between the glass panes suspended within the air cavity and color matched to the extrusion color. A V-groove option is available in select markets.

**EXTENSION JAMBS**

Extension jambs are regionally available for JELD-WEN vinyl products. The 9/16" extension jambs are available in pine clear vinyl wrapped, primed wood, red oak and maple finishes and can be specified on three or four sides of the product.

**BLINDS BETWEEN THE GLASS**

Blinds Between the Glass (BBG) are thermally sealed between tempered safety glass. LightTouch controls raise and lower internal blind. BBG offered in White with clear insulation glass in 5' and 6' widths.

**ADDITIONAL ACCESSORIES**

Additional accessories are available for JELD-WEN Vinyl products. Please contact your local building supply retailer for a complete listing of the additional accessories.

**INSTALLATION**

Installation per JELD-WEN Installation Method for Vinyl Doors JII006 or JII015. See [www.jeld-wen.com/resources](http://www.jeld-wen.com/resources) for instructions.

**PERFORMANCE**

**NFRC Certified** - (rated and labeled in accordance with NFRC)

**AAMA/NWDMA I.S.2-97**  
R20-DP rated

**QUICK SPEC GUIDE**

SPECIFICATION	STANDARD FEATURES	OPTIONAL FEATURES <i>Some options may require additional lead times. Consult your JELD-WEN Sales Representative.</i>
<b>COLOR</b>	<ul style="list-style-type: none"> <li>White</li> </ul>	<ul style="list-style-type: none"> <li>Almond</li> <li>Desert Sand</li> </ul> <p style="text-align: center;"><i>not available in all regions</i></p>
<b>SIZE (Call Out)</b>	<ul style="list-style-type: none"> <li>Width: 5'-0" to 8'-0"</li> <li>Height: 6'-8" to 8'-0"</li> </ul>	<ul style="list-style-type: none"> <li>3-panel doors available regionally</li> <li>Sizes vary by region</li> </ul>
<b>FRAME</b>	<ul style="list-style-type: none"> <li>Integral Nail Fin</li> </ul>	<ul style="list-style-type: none"> <li>Pocket/Block Frame</li> </ul>
<b>GLAZING (All Tempered)</b>	<ul style="list-style-type: none"> <li>Insulating Low-E</li> </ul>	<ul style="list-style-type: none"> <li>Clear</li> <li>Low-E 366</li> <li>Bronze</li> <li>Gray</li> <li>Laminated</li> </ul> <p style="text-align: center;"><i>regional glass availabilities may differ</i></p>
<b>HARDWARE</b>	<ul style="list-style-type: none"> <li>Contour Handle</li> <li>Steel Rollers</li> </ul>	<ul style="list-style-type: none"> <li>Key Cylinder</li> </ul>
<b>HARDWARE COLOR</b>	<ul style="list-style-type: none"> <li>Color matched to extrusion</li> </ul>	
<b>SCREENS</b>	<ul style="list-style-type: none"> <li>Fiberglass</li> </ul>	<ul style="list-style-type: none"> <li>Heavy Duty Frame (available regionally)</li> </ul>
<b>SCREEN FRAME COLOR</b>	<ul style="list-style-type: none"> <li>Color matched to extrusion</li> </ul>	
<b>BLINDS BETWEEN THE GLASS</b>		<ul style="list-style-type: none"> <li>White</li> </ul>
<b>GRILLES</b>		<ul style="list-style-type: none"> <li>1" Contour GBG (grilles between the glass)</li> <li>5/8" Flat GBG (grilles between the glass)</li> <li>5/8" Contour GBG (grilles between the glass) (East)</li> <li>7/8" Flat GBG (grilles between the glass) (East)</li> </ul>
<b>JAMB DEPTH</b>	<ul style="list-style-type: none"> <li>4-9/16" Overall Jamb Depth</li> </ul>	<ul style="list-style-type: none"> <li>5-1/2" Jamb with Stucco Key and Drywall Return (West only)</li> <li>4-9/16" Extension Jambs Applied (East only)</li> <li>6-9/16" Extension Jambs Applied (East only)</li> </ul>
<b>FRAME ACCESSORIES</b>		<ul style="list-style-type: none"> <li>Field Applied</li> <li>West - Dual Wall Flush Fin</li> </ul>

**2-PANEL SLIDING PATIO DOOR**

UNIT SIZE	61 3/4"	73 3/4"	97 3/4"
ROUGH OPENING	60"	72"	96"
FRAME SIZE	59 1/2"	71 1/2"	95 1/2"
DAYLIGHT OPENING	27 7/64" 25 23/64"	33 7/64" 31 23/64"	45 7/64" 43 23/64"

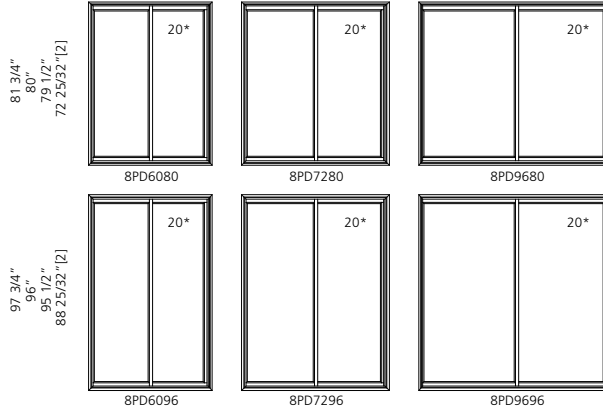

**ELEVATION SYMBOL LEGEND:**  
VALUES IN [ ] ARE NUMBER OF DAYLIGHT OPENINGS PER UNIT  
### NUMBER INDICATES DESIGN PRESSURE (DP) RATING WITH STANDARD GLAZING.

**3-PANEL SLIDING PATIO DOOR**



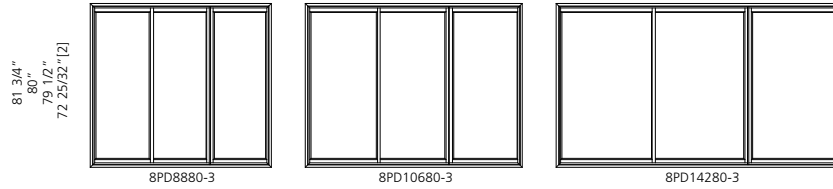

<b>UNIT SIZE</b>	90 1/2"	108 1/2"	144 1/2"
<b>ROUGH OPENING</b>	88 3/4"	106 3/4"	142 3/4"
<b>FRAME SIZE</b>	88 1/4"	106 1/4"	142 1/4"
<b>DAYLIGHT OPENING</b>	26 47/64" 26 7/32" 25 41/64"	32 47/64" 32 7/32" 31 41/64"	44 47/64" 44 7/32" 43 41/64"

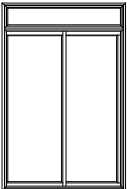
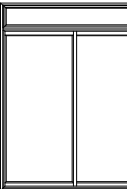
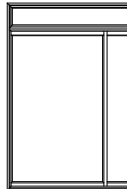
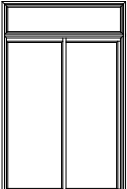

**ELEVATION SYMBOL LEGEND:**  
VALUES IN [ ] ARE NUMBER OF DAYLIGHT OPENINGS PER UNIT

**2-PANEL SLIDING PATIO DOOR WITH TRANSOM**

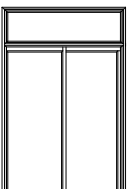
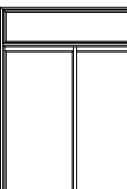
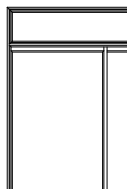
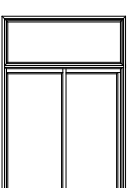
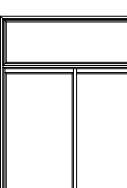
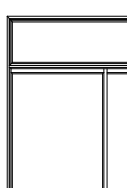
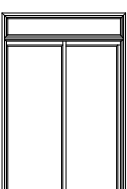
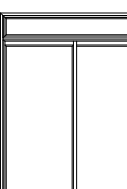
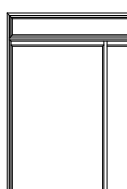
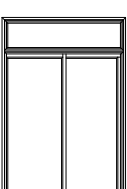
UNIT SIZE	61 3/4"	73 3/4"	97 3/4"
ROUGH OPENING	60"	72"	96"
FRAME SIZE	59 1/2"	71 1/2"	95 1/2"
DAYLIGHT OPENING	27 7/64" 25 23/64" 56 1/4"	33 7/64" 31 23/64" 68 1/4"	45 7/64" 43 23/64" 91 1/4"

93 3/4" 92" 91 1/2" 72 25/32" [2] 18 1/4"			
8PD6092-2TS	8PD7292-2TS	8PD9692-2TS	
97 3/4" 96" 95 1/2" 72 25/32" [2] 12 1/4"			
8PD6096-2TS	8PD7296-2TS	8PD9696-2TS	
99 3/4" 98" 97 1/2" 72 25/32" [2] 14 1/4"			
8PD6098-2TS	8PD7298-2TS	8PD9698-2TS	
105 3/4" 104" 103 1/2" 72 25/32" [2] 20 1/4"			
8PD60104-2TS	8PD72104-2TS	8PD96104-2TS	
109 3/4" 108" 107 1/2" 88 25/32" [2] 18 1/4"			
8PD60108-2TS	8PD72108-2TS	8PD96108-2TS	
113 3/4" 112" 111 1/2" 88 25/32" [2] 12 1/4"			
8PD60112-2TS	8PD72112-2TS	8PD96112-2TS	

**ELEVATION SYMBOL LEGEND:**  
VALUES IN [ ] ARE NUMBER OF DAYLIGHT OPENINGS PER UNIT

SCALE: 1/8" = 1'

**2-PANEL SLIDING PATIO DOOR WITH TRANSOM**

	61 3/4"	73 3/4"	97 3/4"
<b>UNIT SIZE</b>	61 3/4"	73 3/4"	97 3/4"
<b>ROUGH OPENING</b>	60"	72"	96"
<b>FRAME SIZE</b>	59 1/2"	71 1/2"	95 1/2"
<b>DAYLIGHT OPENING</b>	27 7/64" 25 23/64" 56 1/4"	33 7/64" 31 23/64" 68 1/4"	45 7/64" 43 23/64" 91 1/4"

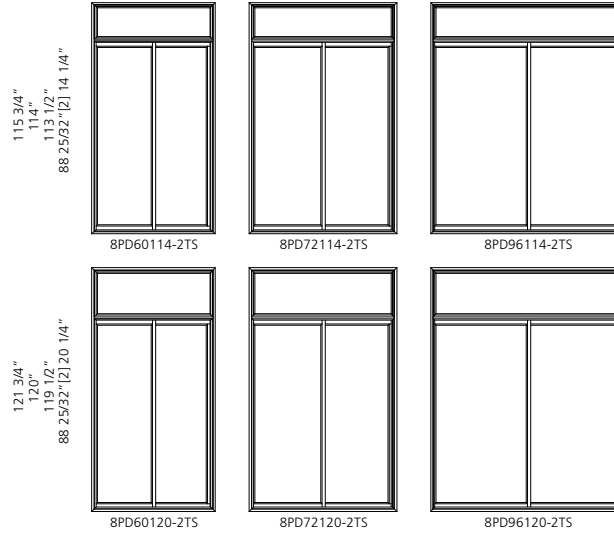

**ELEVATION SYMBOL LEGEND:**  
VALUES IN [ ] ARE NUMBER OF DAYLIGHT OPENINGS PER UNIT

**SIDELITE**

UNIT SIZE  
ROUGH OPENING  
FRAME SIZE  
DAYLIGHT OPENING

13 3/4"  
12"  
11 1/2"  
8 1/4"

16 3/4"  
15"  
14 1/2"  
11 1/4"

19 3/4"  
18"  
17 1/2"  
14 1/4"

25 3/4"  
24"  
23 1/2"  
20 1/4"

31 3/4"  
30"  
29 1/2"  
26 1/4"

37 3/4"  
36"  
35 1/2"  
32 1/4"

43 3/4"  
42"  
41 1/2"  
38 1/4"

49 3/4"  
48"  
47 1/2"  
44 1/4"

81 3/4"  
80"  
79 1/2"  
72 3/4"

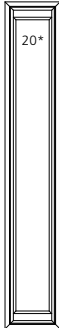

8PI1280

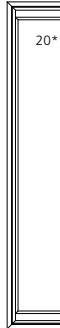

8PI1580

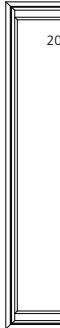

8PI1280



8PI2480

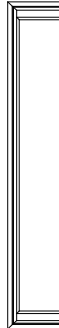

8PI3080



8PI3680

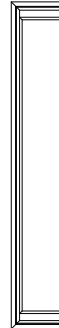

8PI4280



8PI4880

97 3/4"  
96"  
95 1/2"  
88 3/4"

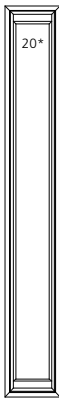

8PI1296

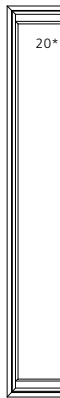

8PI1596

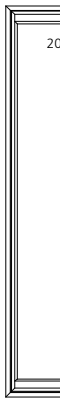

8PI1296



8PI2496

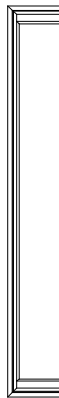

8PI3096



8PI3696

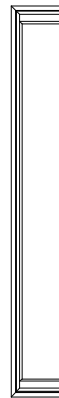

8PI4296



8PI4896











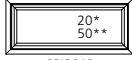

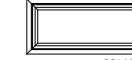

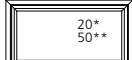

**ELEVATION SYMBOL LEGEND:**

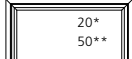

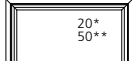

### NUMBER INDICATES DESIGN PRESSURE (DP) RATING WITH STANDARD GLAZING.

SCALE: 1/4" = 1'



**TRANSOM**

UNIT SIZE	31 3/4"	37 3/4"	49 3/4"	61 3/4"	73 3/4"
ROUGH OPENING	30"	36"	48"	60"	72"
FRAME SIZE	29 1/2"	35 1/2"	47 1/2"	59 1/2"	71 1/2"
DAYLIGHT OPENING	26 1/4"	32 1/4"	44 1/4"	56 1/4"	68 1/4"
13 3/4" 12" 11 1/2" 8 1/4"	 20* 50** 8PI3012	 20* 50** 8PI3612	 20* 50** 8PI4812	 20* 50** 8PI6012	 20* 50** 8PI7212
17 3/4" 16" 15 1/2" 12 1/4"	 20* 50** 8PI3016	 20* 50** 8PI3616	 20* 50** 8PI4816	 20* 50** 8PI6016	 20* 50** 8PI7216
19 3/4" 18" 17 1/2" 14 1/4"	 20* 50** 8PI3018	 20* 50** 8PI3618	 20* 50** 8PI4818	 20* 50** 8PI6018	 20* 50** 8PI7218
25 3/4" 24" 23 1/2" 20 1/4"	 20* 50** 8PI3024	 20* 50** 8PI3624	 20* 50** 8PI4824	 20* 50** 8PI6024	 20* 50** 8PI7224

UNIT SIZE	97 3/4"
ROUGH OPENING	96"
FRAME SIZE	95 1/2"
DAYLIGHT OPENING	92 1/4"
13 3/4" 12" 11 1/2" 8 1/4"	 20* 50** 8PI9612
17 3/4" 16" 15 1/2" 12 1/4"	 20* 50** 8PI9616
19 3/4" 18" 17 1/2" 14 1/4"	 20* 50** 8PI9618
25 3/4" 24" 23 1/2" 20 1/4"	 20* 50** 8PI9624

**ELEVATION SYMBOL LEGEND:**  
 ##\* NUMBER INDICATES DESIGN PRESSURE (DP) RATING WITH STANDARD GLAZING.  
 ###\* NUMBER INDICATES OPTIONAL DESIGN PRESSURE (DP) RATING.

SCALE: 1/4" = 1'

**3-PANEL TRANSOM**

UNIT SIZE	90 1/2"	108 1/2"	144 1/2"
ROUGH OPENING	88 3/4"	106 3/4"	142 3/4"
FRAME SIZE	88 1/4"	106 1/4"	142 1/4"
DAYLIGHT OPENING	85"	103"	139"
27 47/64" 24" 23 1/2" 20 1/4"	17 47/64" 16" 15 1/2" 12 1/4"	13 47/64" 12" 11 1/2" 8 1/4"	
8PI8812	20* 50***	20*	20*
8PI8816	20* 50***	20*	20*
8PI8818	20* 50***	20*	20*
8PI8824	20* 50***	20*	20*

**ELEVATION SYMBOL LEGEND:**  
 \*\*\* NUMBER INDICATES DESIGN PRESSURE (DP) RATING WITH STANDARD GLAZING.  
 \*\*\*\* NUMBER INDICATES OPTIONAL DESIGN PRESSURE (DP) RATING.

SCALE: 1/8" = 1'

GRILLE PATTERNS

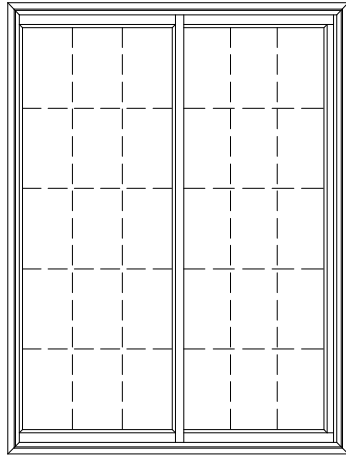

STANDARD

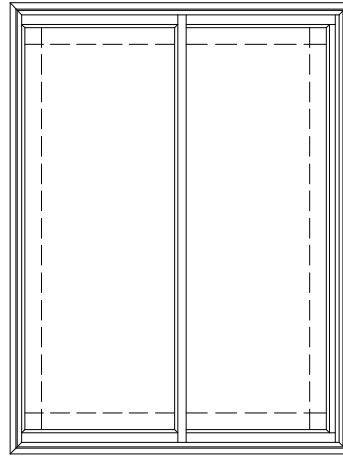

PRAIRIE

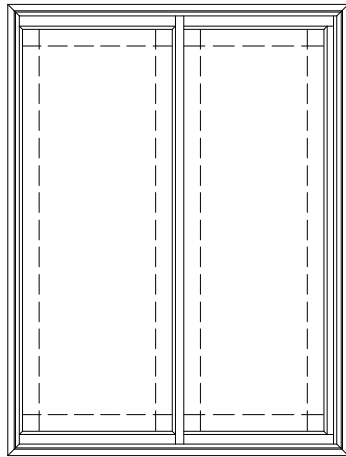

PRAIRIE SASH

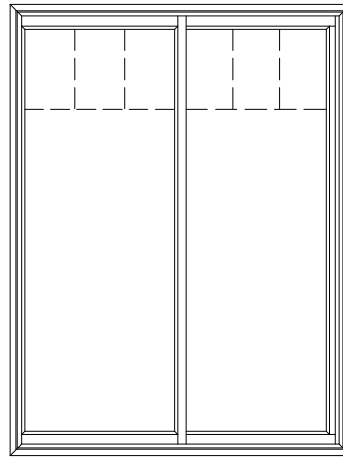

COLONIAL TOP SASH  
1/2 LITE



**2-PANEL SLIDING PATIO DOOR**

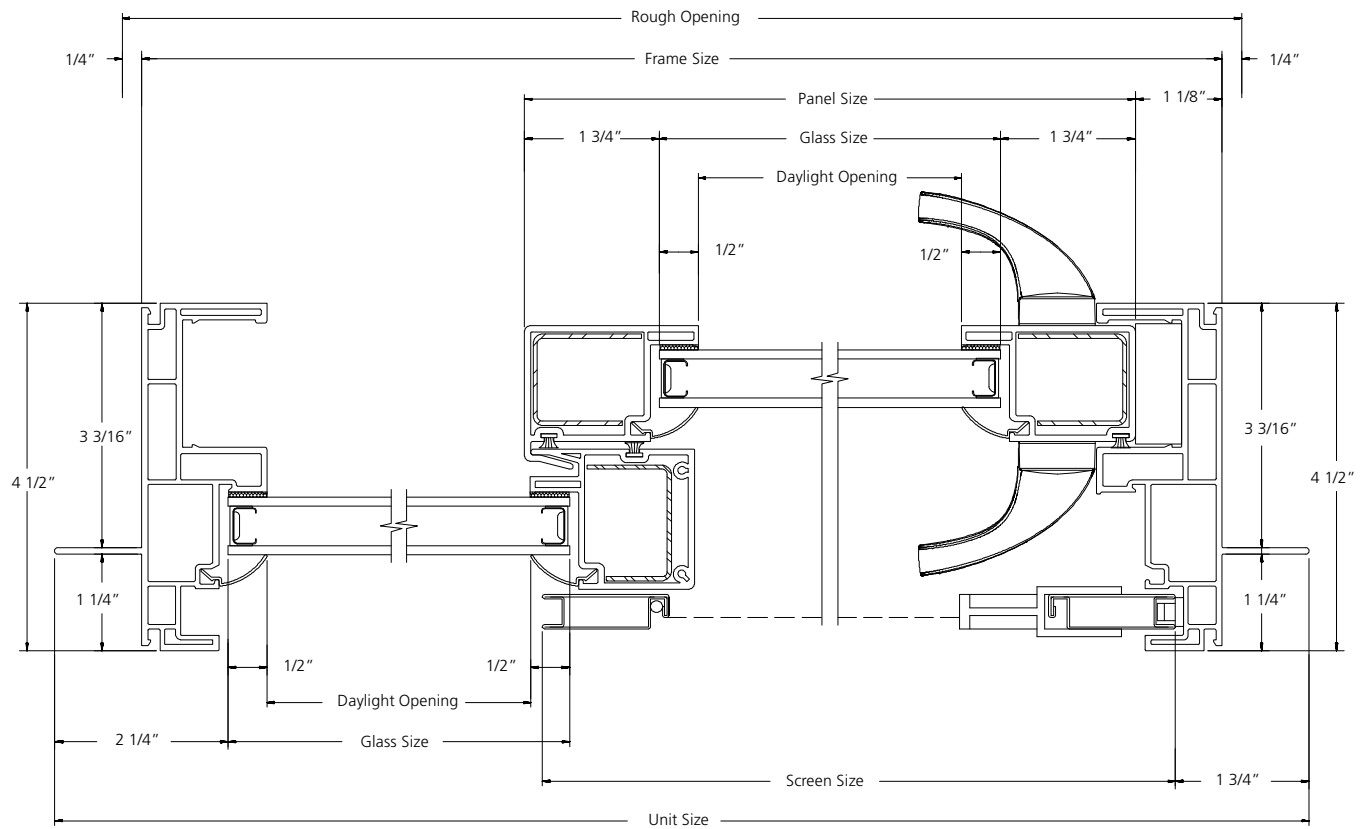

**HORIZONTAL SECTION**

SCALE: 6" = 1'

**3-PANEL SLIDING PATIO DOOR  
XOX**

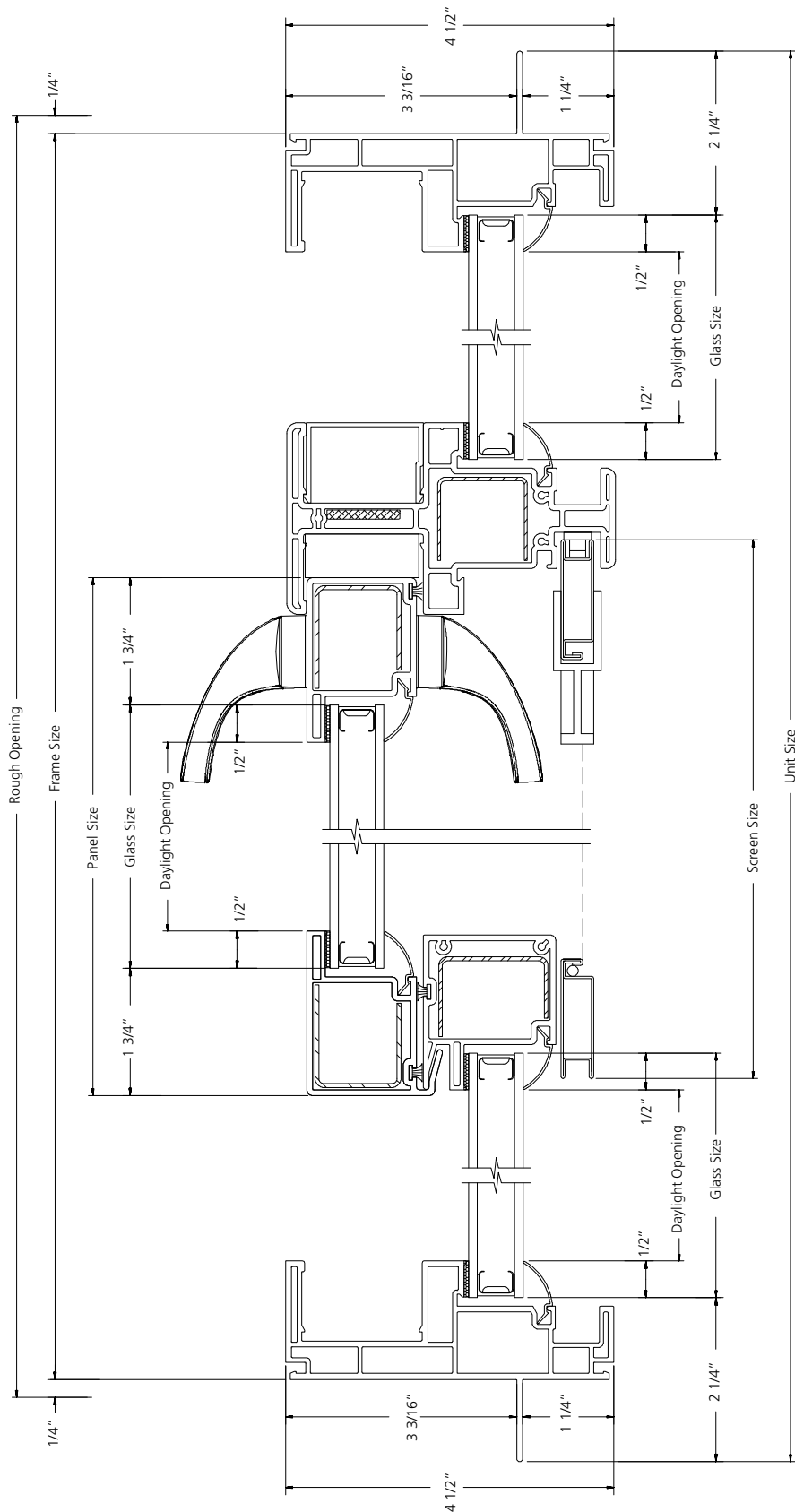

**HORIZONTAL SECTION**

SCALE: 6" = 1'

**3-PANEL SLIDING PATIO DOOR  
 XXO**

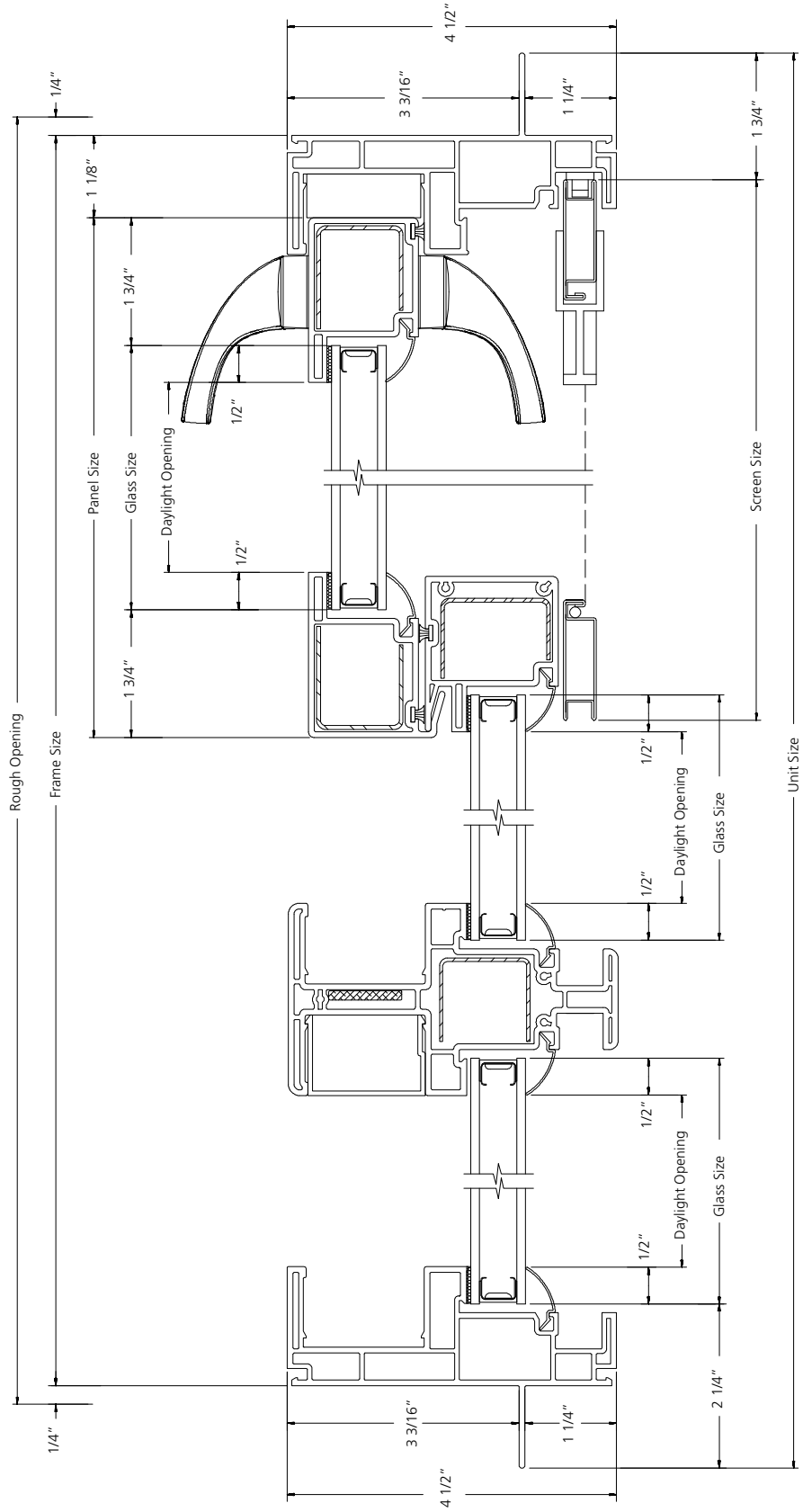

**HORIZONTAL SECTION**

SCALE: 6" = 1'

2-PANEL SLIDING PATIO DOOR WITH TRANSOM

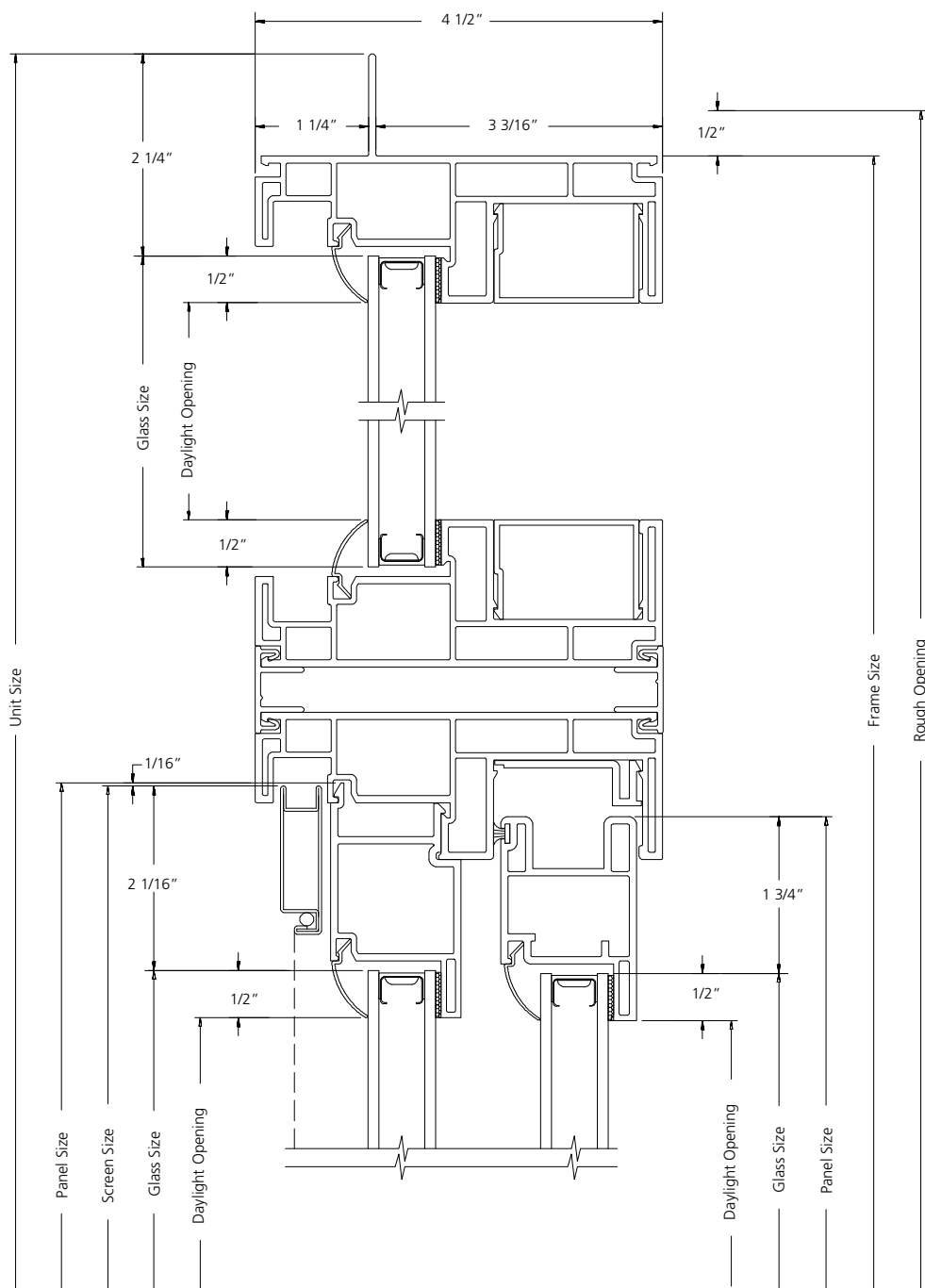

VERTICAL SECTION

SCALE: 6" = 1'



**SIDELITE**

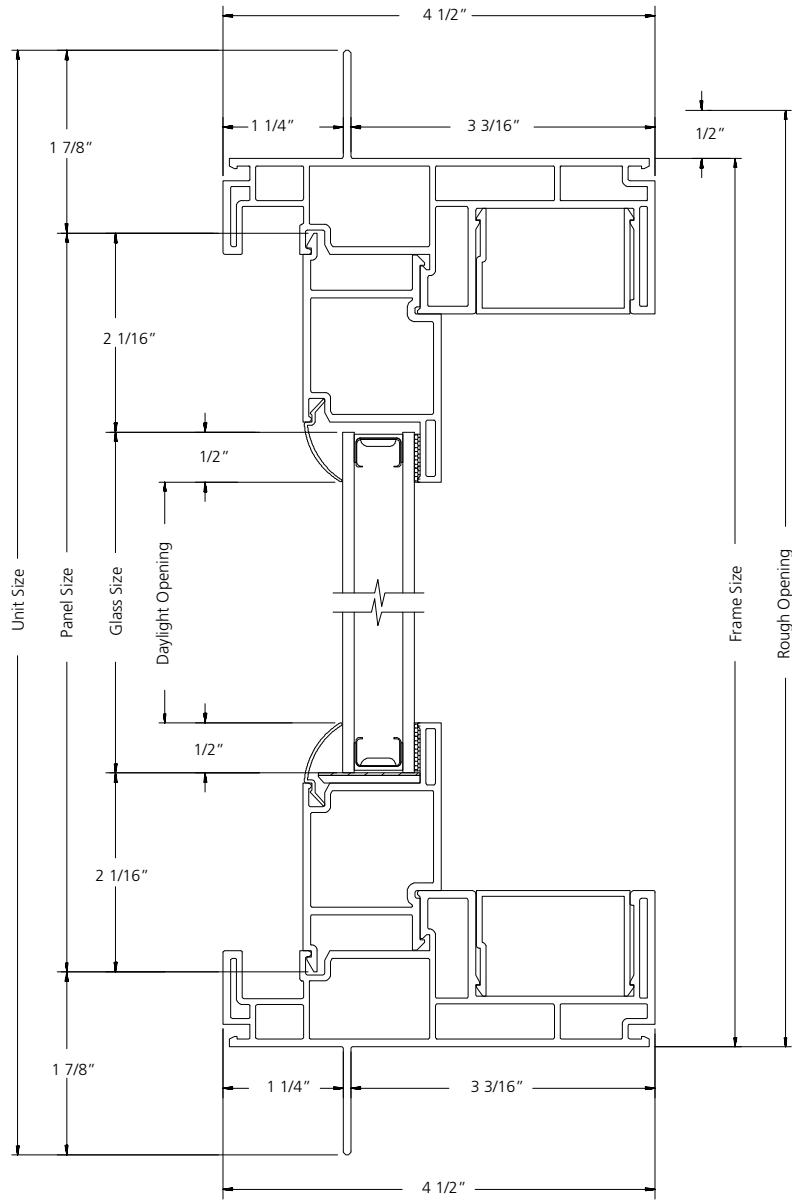

**VERTICAL SECTION**

SCALE: 6" = 1'

**SIDELITE**

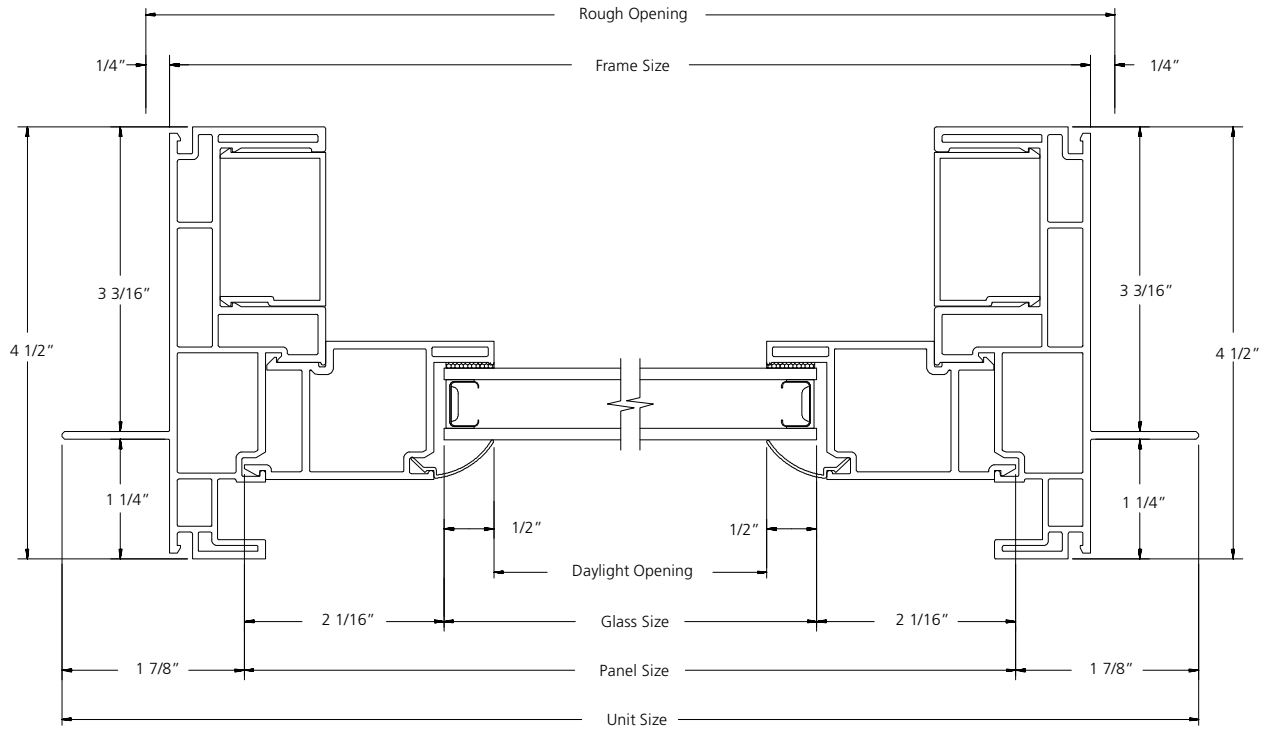

**HORIZONTAL SECTION**

SCALE: 6" = 1'

TRANSOM

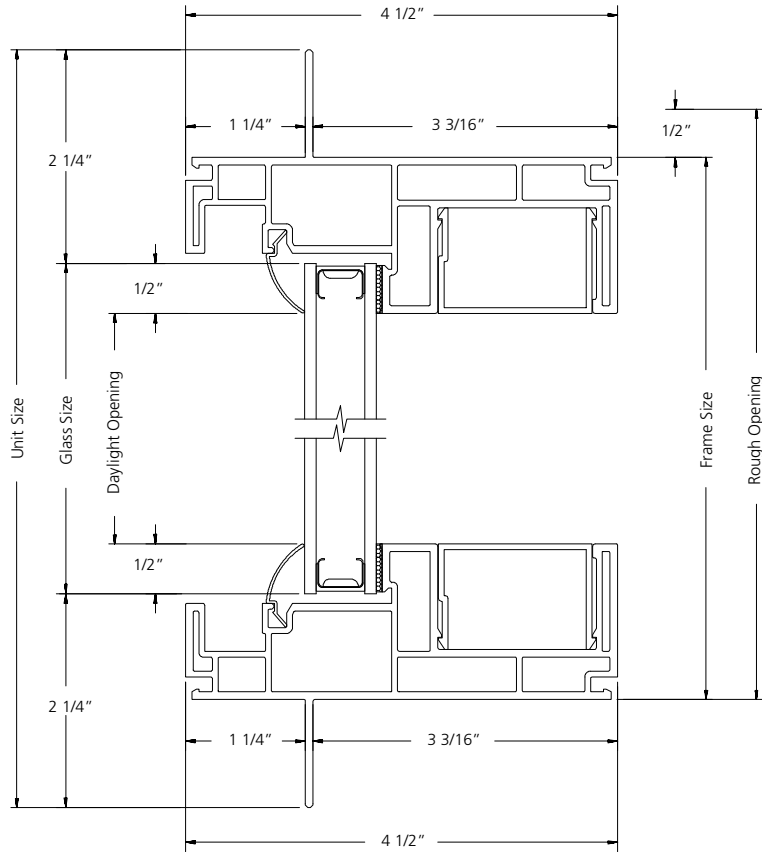

VERTICAL SECTION

SCALE: 6" = 1'

**TRANSOM**

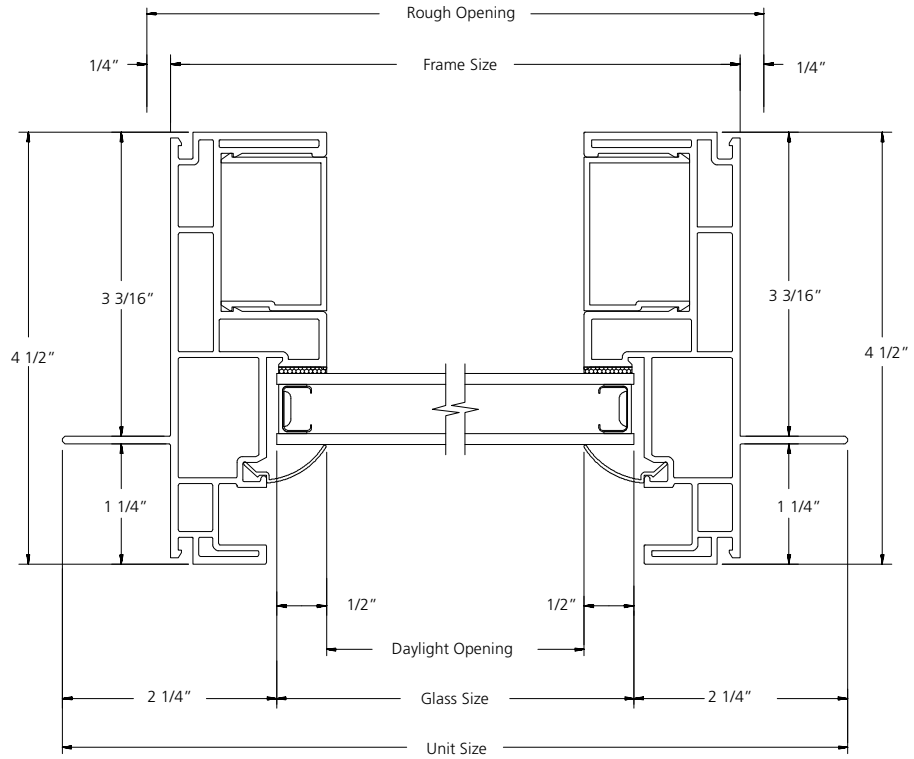

**HORIZONTAL SECTION**

SCALE: 6" = 1'