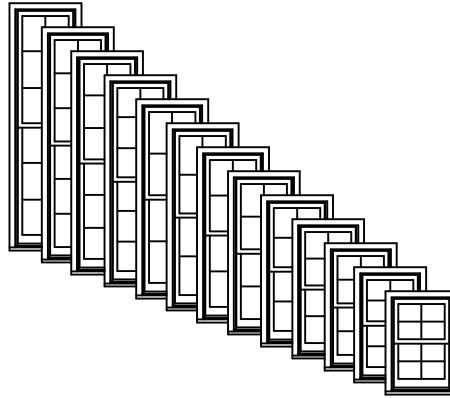

TABLE OF CONTENTS

General Information	10-2
Elevation Notes	10-3
Light Cut Information	10-6
Clear Opening.	10-10
Operation and Sash Tilt.	10-12
Unit Sizing, Rough Openings & Masonry Openings	10-13
Trim Options	10-14
Sill Options	10-15
Bay Specifications	10-16
Glazing Options	10-17
Jamb Extender Options.	10-22
Mullion Options	10-23
Bay Rough Opening	10-26
Single Hung General Information	10-27
Single Hung Elevation Notes	10-28
Single Hung Clear Opening	10-29
Single Hung Operation and Sash Tilt	10-31
Single Hung Unit Sizing, Rough Openings & Masonry Openings	10-32
Single Hung Light Cut Table	10-33
Elevations/Sizes	10-34
Section Details	10-97

GENERAL INFORMATION



DIMENSIONAL WINDOWS

Wood double hung windows may be specified as "dimensional", by adjusting the desired rough opening width or height in 1/16" increments from standard.

Wood double hung windows feature fully operating upper and lower sash. Counterbalancing is achieved with block and tackle spring extension systems hidden in weatherable PVC concealed jamb liners. Operating units are supplied with cam style sash locks which control the concealed tilt latch system at the meeting rails. Combined with the recessed tilt latches in the upper sash, both sash can easily be removed or installed in the field. Exposed tilt latches are available with the "old style" meeting rail configuration. There are several hardware finish options. Refer to the Specifications for available finish options.

MULTIPLE ASSEMBLIES

Wood double hung windows may be mullied beside other wood double hungs or wood picture windows, or below wood transom windows, to fulfill a wide variety of needs. Factory assembled mulls are limited in height (100"), width (114"), and a total area (75 square feet).

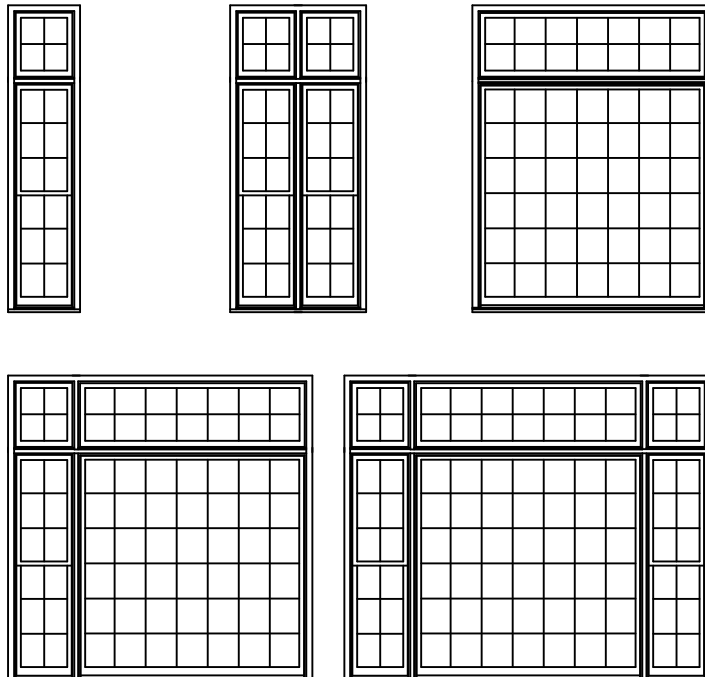

ELEVATION NOTES
DOUBLE-HUNG

ELEVATION DRAWINGS UTILIZE A LIMITED NUMBER OF PROJECTED LINES TO PRODUCE A RUDIMENTARY DRAWING INTENDED TO BE USED IN A SMALL GRAPHICAL SCALE. ELEVATIONS ARE VIEWED PERPENDICULAR FROM THE EXTERIOR OF THE STRUCTURE. IF MORE DIMENSIONS ARE NEEDED, USE THE SECTION DRAWINGS FOR MORE COMPLETE DEPICTIONS.

DOUBLE HUNG WINDOW

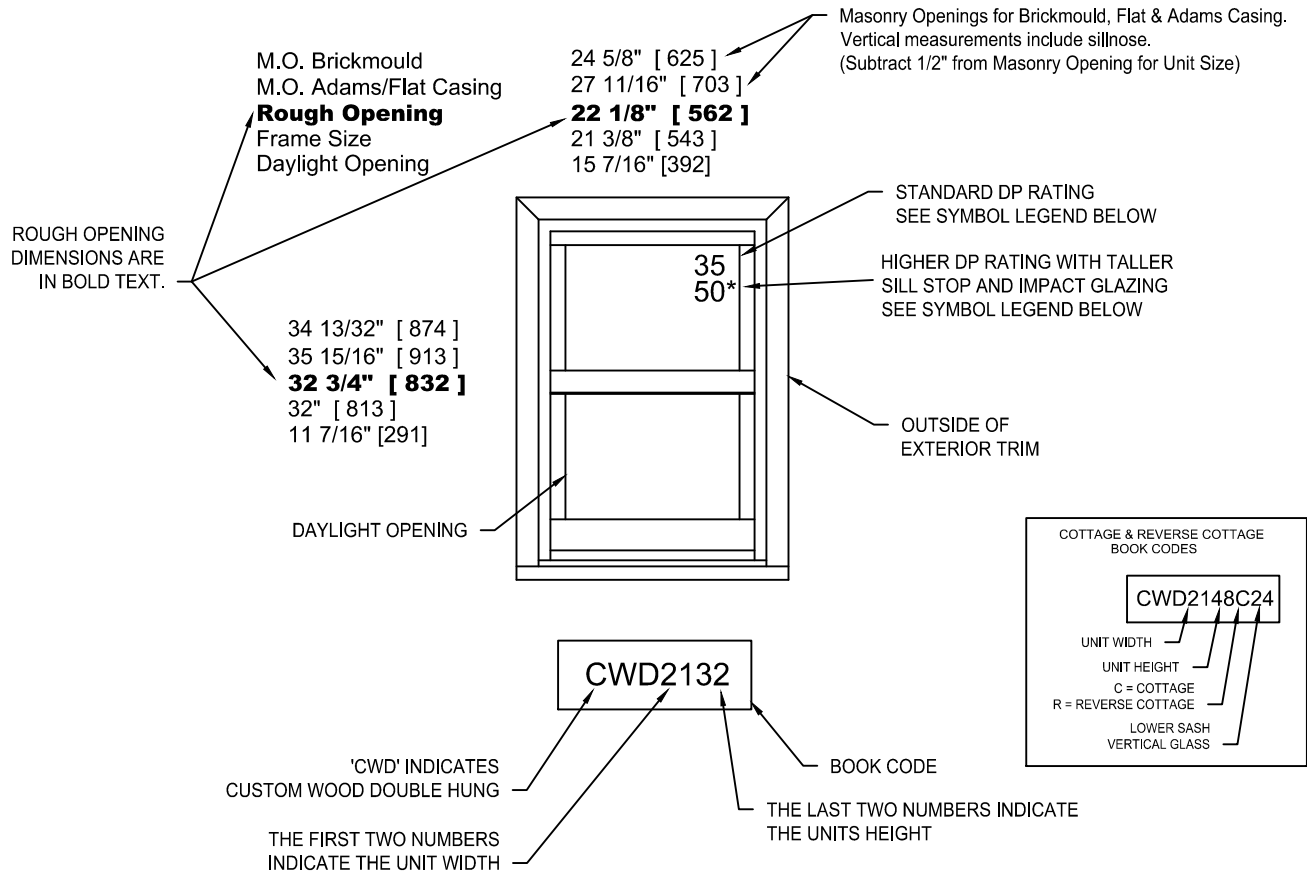

GENERAL WOOD DOUBLE HUNG NOTES

1. ALL UNITS SHOWN ARE AVAILABLE AS OPERATORS ONLY.
2. UNIT ELEVATIONS ARE SHOWN WITH BRICKMOULD & SILLNOSE.
3. ALL OPERATING SASH ARE INSTALLED WITH VINYL JAMB LINERS AND OPERATED WITH AN INTERNAL BLOCK AND TACKLE SPRING SYSTEM.
4. DIMENSIONAL VALUES IN BRACKETS ARE MILLIMETER CONVERSIONS.

ELEVATION SYMBOL LEGEND:

- E** UNIT MEETS EGRESS REQUIREMENT FOR IRC CODE. STATE AND LOCAL EGRESS CODES MAY DIFFER. ALWAYS REFER TO LOCAL BUILDING CODES FOR COMPLETE REQUIREMENTS. CHECK WITH LOCAL OFFICIALS TO ENSURE COMPLIANCE BEFORE INSTALLING THE UNIT.
- E1** BASIC UNIT CLEAR OPENING EXCEEDS 20" IN WIDTH, 24" IN HEIGHT & A MINIMUM OF 5.0 SQ. FT., FOR FIRST FLOOR EGRESS.
- T** BASIC UNIT IS NOT AVAILABLE WITH TRI-PANE GLASS.
- ##** NUMBER INDICATES DESIGN PRESSURE (DP) RATING WITH STANDARD GLAZING.
- ##*** NUMBER INDICATES HIGHER DP RATING, TALLER SILL STOP AND IMPACT GLAZING.

ELEVATION NOTES
DOUBLE-HUNG PICTURE

ELEVATION DRAWINGS UTILIZE A LIMITED NUMBER OF PROJECTED LINES TO PRODUCE A RUDIMENTARY DRAWING INTENDED TO BE USED IN A SMALL GRAPHICAL SCALE. ELEVATIONS ARE VIEWED PERPENDICULAR FROM THE EXTERIOR OF THE STRUCTURE. IF MORE DIMENSIONS ARE NEEDED, USE THE SECTION DRAWINGS FOR MORE COMPLETE DEPICTIONS.

PICTURE WINDOW

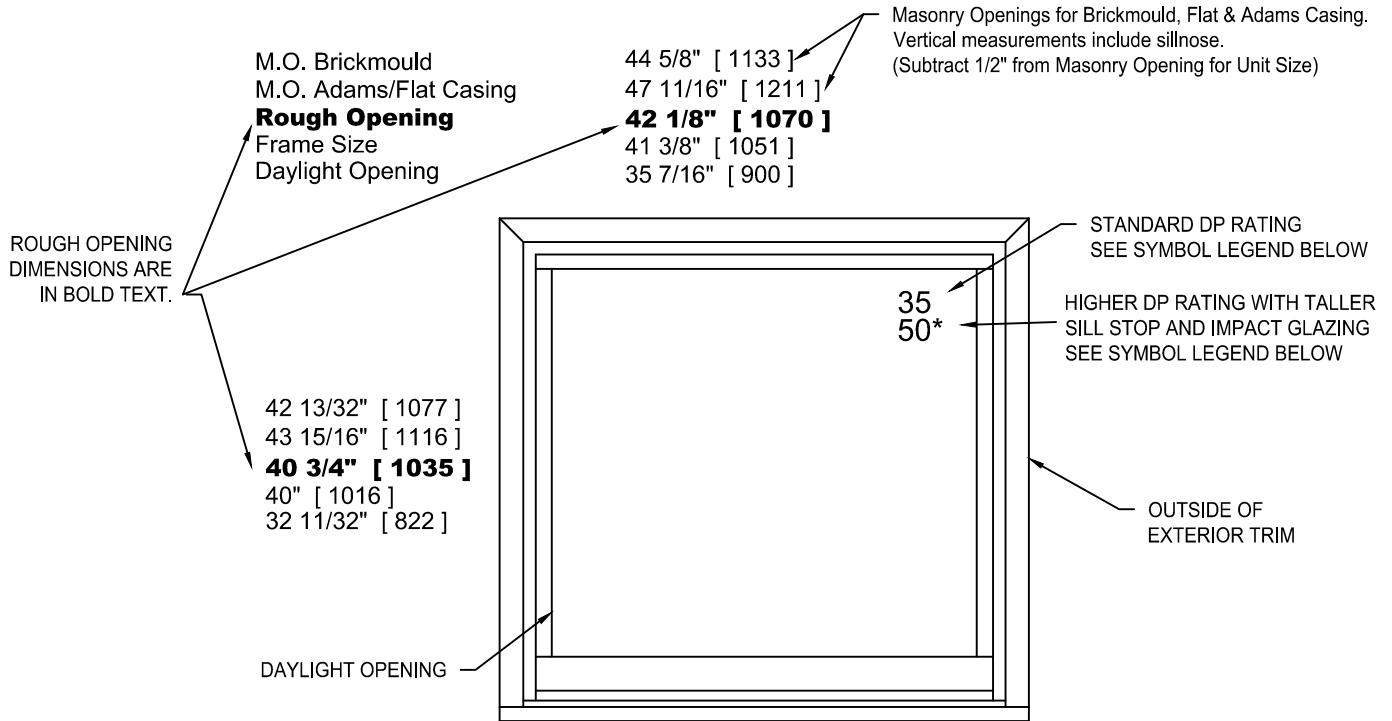

CWDP4140

'CWDP' INDICATES CUSTOM WOOD DH PICTURE

THE FIRST TWO NUMBERS INDICATE THE UNIT WIDTH

BOOK CODE

THE LAST TWO NUMBERS INDICATE THE UNITS HEIGHT

GENERAL DOUBLE HUNG PICTURE NOTES

1. ALL UNITS SHOWN ARE AVAILABLE AS STATIONARY ONLY.
2. UNIT ELEVATIONS ARE SHOWN WITH BRICKMOULD AND SILLNOSE.
3. DIMENSIONAL VALUES IN BRACKETS ARE MILLIMETER CONVERSIONS.

ELEVATION SYMBOL LEGEND:

- T** BASIC UNIT IS NOT AVAILABLE WITH TRI-PANE GLASS.
- ##** NUMBER INDICATES DESIGN PRESSURE (DP) RATING WITH STANDARD GLAZING.
- ##*** NUMBER INDICATES HIGHER DP RATING, TALLER SILL STOP AND IMPACT GLAZING.

ELEVATION NOTES
DOUBLE-HUNG TRANSOM

ELEVATION DRAWINGS UTILIZE A LIMITED NUMBER OF PROJECTED LINES TO PRODUCE A RUDIMENTARY DRAWING INTENDED TO BE USED IN A SMALL GRAPHICAL SCALE. ELEVATIONS ARE VIEWED PERPENDICULAR FROM THE EXTERIOR OF THE STRUCTURE. IF MORE DIMENSIONS ARE NEEDED, USE THE SECTION DRAWINGS FOR MORE COMPLETE DEPICTIONS.

TRANSOM WINDOW

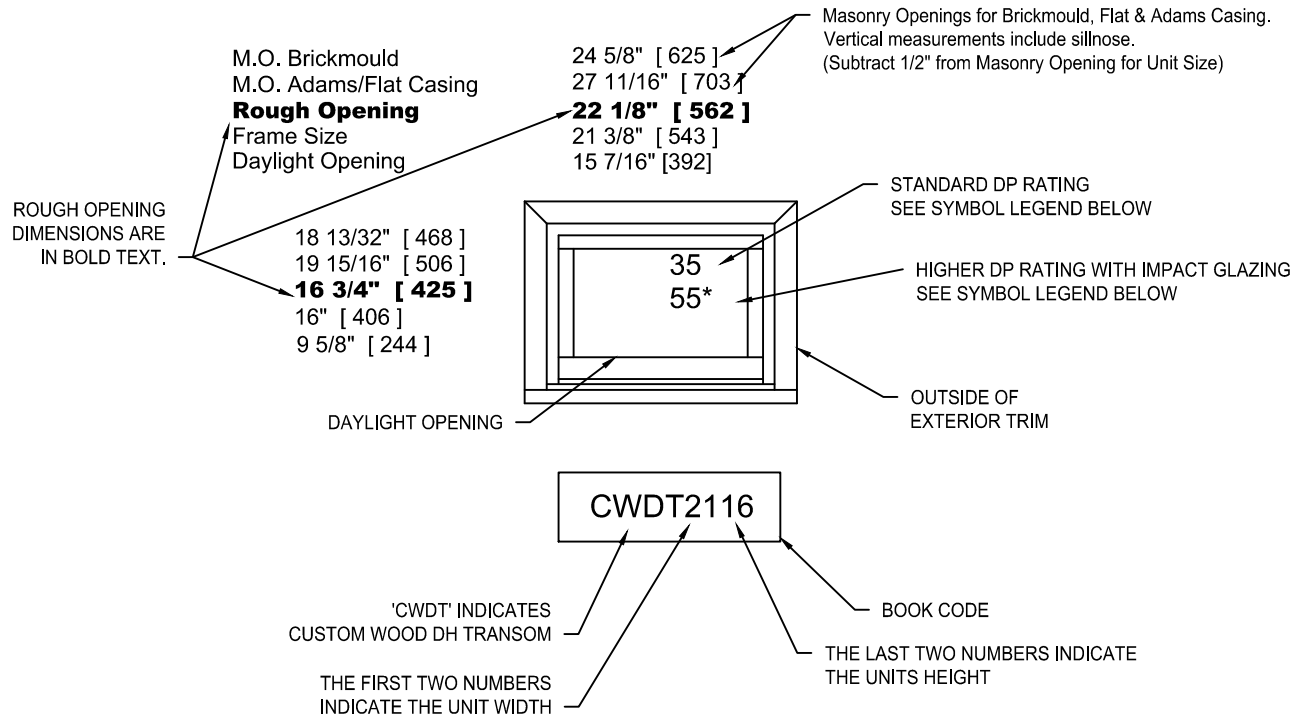

GENERAL DOUBLE HUNG TRANSOM NOTES

1. ALL UNITS SHOWN ARE AVAILABLE AS STATIONARY ONLY.
2. UNIT ELEVATIONS ARE SHOWN WITH BRICKMOULD & SILLNOSE.
2. DIMENSIONAL VALUES IN BRACKETS ARE MILLIMETER CONVERSIONS.

ELEVATION SYMBOL LEGEND:

- ## NUMBER INDICATES DESIGN PRESSURE (DP) RATING WITH STANDARD GLAZING.
- ##* NUMBER INDICATES HIGHER DP RATING WITH IMPACT GLAZING.

LITE CUT INFORMATION

Wood double hung windows are available with removable grilles in 7/8", 1-1/8" and 1-3/8" widths, grilles between glass (GBG), and Simulated Divided Lites. Standard lite cuts are rectangular, and conform to the layouts noted in the charts on the next page. To use the chart, refer to the appropriate table by the type of window and type of bars or grilles the section drawings illustrate. Then simply cross reference the frame Height and Width to determine the standard lite cut.

LITE CUT OPTIONS

Special lite cut patterns can include a wide variety of straight line and radius patterns. The illustrations shown here represent just a few of the possibilities. Rectangular, horizontal, vertical and Prairie lite patterns are available in all standard size wood double hung windows. Uneven, diamond, radius and Gothic lite cuts are available, subject to approval. Approvals are based on the ability to fulfill the design requirement while maintaining the construction integrity of the finished product.

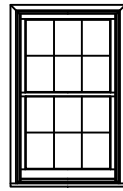

RECTANGULAR

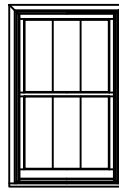

VERTICAL

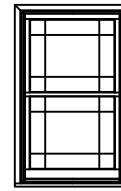

PRAIRIE

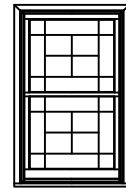

UNEVEN

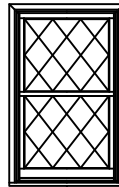

DIAMOND

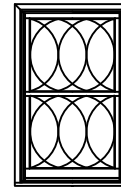

RADIUS

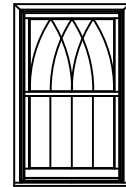

GOTHIC

BAR ALIGNMENT

Alignment of divided lite muntin bars from one window to the next is often required by fine architectural design. Wood grilles, GBG's, and Simulated Divided Lites may be specified with muntin bars aligned.

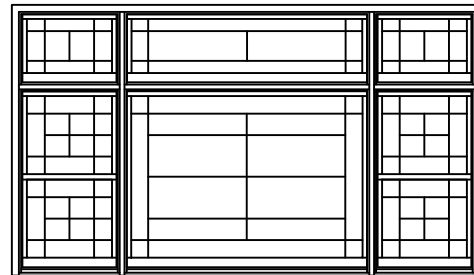

LITE CUTE TABLE - DOUBLE-HUNG

DOUBLE HUNG WINDOWS - CWD

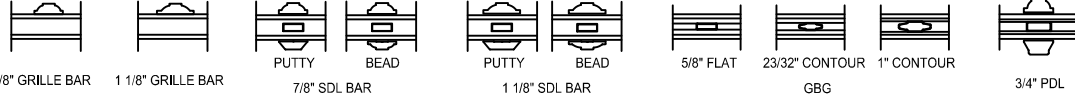
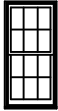

CWD		Frame Height															
		32	36	40	44	48	52	56	60	64	68	72	76	80	88	92	96
Frame Width	21	21 3/8	2W 2H	2W 2H	2W 2H	2W 2H	2W 2H	2W 2H	2W 2H	2W 2H	2W 2H	2W 3H	2W 3H	2W 3H	2W 4H	2W 4H	2W 4H
	25	25 3/8	3W 2H	3W 2H	3W 2H	3W 2H	3W 2H	3W 2H	3W 2H	3W 2H	3W 2H	3W 3H	3W 3H	3W 3H	3W 4H	3W 4H	3W 4H
	29	29 3/8	3W 2H	3W 2H	3W 2H	3W 2H	3W 2H	3W 2H	3W 2H	3W 2H	3W 2H	3W 3H	3W 3H	3W 3H	3W 4H	3W 4H	3W 4H
	31	31 3/8	3W 2H	3W 2H	3W 2H	3W 2H	3W 2H	3W 2H	3W 2H	3W 2H	3W 2H	3W 3H	3W 3H	3W 3H	3W 4H	3W 4H	3W 4H
	33	33 3/8	3W 2H	3W 2H	3W 2H	3W 2H	3W 2H	3W 2H	3W 2H	3W 2H	3W 2H	3W 3H	3W 3H	3W 3H	3W 4H	3W 4H	3W 4H
	35	35 3/8	4W 2H	4W 2H	4W 2H	4W 2H	4W 2H	4W 2H	4W 2H	4W 2H	4W 2H	4W 3H	4W 3H	4W 3H	4W 4H	4W 4H	4W 4H
	37	37 3/8	4W 2H	4W 2H	4W 2H	4W 2H	4W 2H	4W 2H	4W 2H	4W 2H	4W 2H	4W 3H	4W 3H	4W 3H	4W 4H	4W 4H	4W 4H
	41	41 3/8	4W 2H	4W 2H	4W 2H	4W 2H	4W 2H	4W 2H	4W 2H	4W 2H	4W 2H	4W 3H	4W 3H	4W 3H	4W 4H	NA	NA
	45	45 3/8	4W 2H	4W 2H	4W 2H	4W 2H	4W 2H	4W 2H	4W 2H	4W 2H	4W 2H	4W 3H	4W 3H	4W 3H	4W 4H	NA	NA
	49	49 3/8	4W 2H	4W 2H	4W 2H	4W 2H	4W 2H	4W 2H	4W 2H	4W 2H	4W 2H	4W 3H	4W 3H	4W 3H	NA	NA	NA



CWD		Frame Height															
		32	36	40	44	48	52	56	60	64	68	72	76	80	88	92	96
Frame Width	21	21 3/8	2W 1H	2W 1H	2W 2H	2W 2H	2W 2H	2W 2H	2W 2H	2W 2H	2W 2H	2W 3H	2W 3H	2W 3H	2W 4H	2W 4H	2W 4H
	25	25 3/8	2W 1H	2W 1H	2W 2H	2W 2H	2W 2H	2W 2H	2W 2H	2W 2H	2W 2H	2W 3H	2W 3H	2W 3H	2W 4H	2W 4H	2W 4H
	29	29 3/8	3W 1H	3W 1H	3W 2H	3W 2H	3W 2H	3W 2H	3W 2H	3W 2H	3W 2H	3W 3H	3W 3H	3W 3H	3W 4H	3W 4H	3W 4H
	31	31 3/8	3W 1H	3W 1H	3W 2H	3W 2H	3W 2H	3W 2H	3W 2H	3W 2H	3W 2H	3W 3H	3W 3H	3W 3H	3W 4H	3W 4H	3W 4H
	33	33 3/8	3W 1H	3W 1H	3W 2H	3W 2H	3W 2H	3W 2H	3W 2H	3W 2H	3W 2H	3W 3H	3W 3H	3W 3H	3W 4H	3W 4H	3W 4H
	35	35 3/8	3W 1H	3W 1H	3W 2H	3W 2H	3W 2H	3W 2H	3W 2H	3W 2H	3W 2H	3W 3H	3W 3H	3W 3H	3W 4H	3W 4H	3W 4H
	37	37 3/8	3W 1H	3W 1H	3W 2H	3W 2H	3W 2H	3W 2H	3W 2H	3W 2H	3W 2H	3W 3H	3W 3H	3W 3H	3W 4H	3W 4H	3W 4H
	41	41 3/8	4W 1H	4W 1H	4W 2H	4W 2H	4W 2H	4W 2H	4W 2H	4W 2H	4W 2H	4W 3H	4W 3H	4W 3H	4W 4H	NA	NA
	45	45 3/8	4W 1H	4W 1H	4W 2H	4W 2H	4W 2H	4W 2H	4W 2H	4W 2H	4W 2H	4W 3H	4W 3H	4W 3H	4W 4H	NA	NA
	49	49 3/8	4W 2H	4W 2H	4W 2H	4W 2H	4W 2H	4W 2H	4W 2H	4W 2H	4W 2H	4W 3H	4W 3H	4W 3H	NA	NA	NA

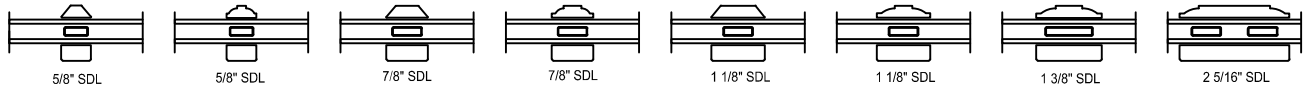

CONTEMPORARY SDL

LITE CUT TABLES - PICTURE & TRANSOM

PICTURE WINDOWS - CWDP

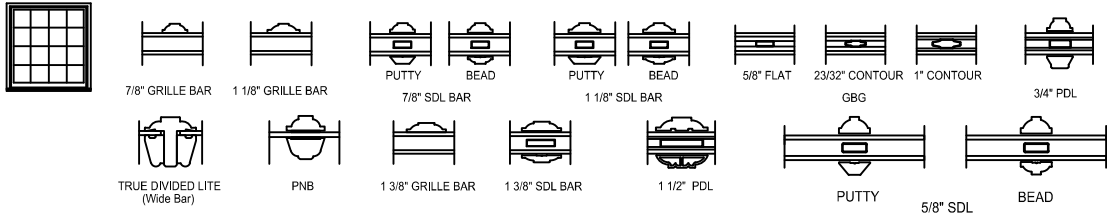

CWDP		Frame Height														
		40	44	48	52	56	60	64	68	72	76	80	88	92	96	
Frame Width	41	41 3/8	4W 4H	4W 4H	4W 4H	4W 4H	4W 4H	4W 4H	4W 4H	4W 4H	4W 6H	4W 6H	4W 6H	4W 8H	4W 8H	4W 8H
	45	45 3/8	4W 4H	4W 4H	4W 4H	4W 4H	4W 4H	4W 4H	4W 4H	4W 4H	4W 6H	4W 6H	4W 6H	4W 8H	4W 8H	4W 8H
	49	49 3/8	4W 4H	4W 4H	4W 4H	4W 4H	4W 4H	4W 4H	4W 4H	4W 4H	4W 6H	4W 6H	4W 6H	4W 8H	4W 8H	4W 8H
	53	53 3/8	4W 4H	4W 4H	4W 4H	4W 4H	4W 4H	4W 4H	4W 4H	4W 4H	4W 6H	4W 6H	4W 6H	4W 8H	4W 8H	4W 8H
	61	61 3/8	5W 4H	5W 4H	5W 4H	5W 4H	5W 4H	5W 4H	5W 4H	5W 4H	5W 6H	5W 6H	5W 6H	5W 8H	5W 8H	5W 8H
	69	69 3/8	6W 4H	6W 4H	6W 4H	6W 4H	6W 4H	6W 4H	6W 4H	6W 4H	6W 6H	6W 6H	6W 6H	6W 8H	6W 8H	6W 8H
	77	77 3/8	7W 4H	7W 4H	7W 4H	7W 4H	7W 4H	7W 4H	7W 4H	7W 4H	7W 6H	7W 6H	7W 6H	7W 8H	7W 8H	NA

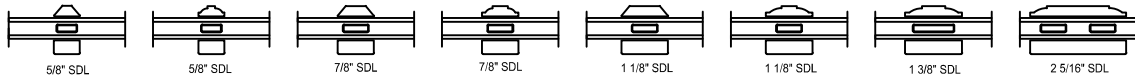

CONTEMPORARY SDL

TRANSOM WINDOWS - CWDP

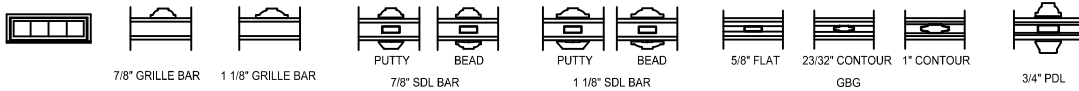

CWDT		Frame Height										
		12	14	16	18	20	24	30	36	42	48	
Frame Width	21	21 3/8	2W 1H	2W 1H	2W 1H	2W 1H	2W 1H	2W 2H	2W 2H	2W 3H	2W 3H	2W 4H
	25	25 3/8	3W 1H	3W 1H	3W 1H	3W 1H	3W 1H	3W 2H	3W 2H	3W 3H	3W 3H	3W 4H
	29	29 3/8	3W 1H	3W 1H	3W 1H	3W 1H	3W 1H	3W 2H	3W 2H	3W 3H	3W 3H	3W 4H
	31	31 3/8	3W 1H	3W 1H	3W 1H	3W 1H	3W 1H	3W 2H	3W 2H	3W 3H	3W 3H	3W 4H
	33	33 3/8	3W 1H	3W 1H	3W 1H	3W 1H	3W 1H	3W 2H	3W 2H	3W 3H	3W 3H	3W 4H
	35	35 3/8	4W 1H	4W 1H	4W 1H	4W 1H	4W 1H	4W 2H	4W 2H	4W 3H	4W 3H	4W 4H
	37	37 3/8	4W 1H	4W 1H	4W 1H	4W 1H	4W 1H	4W 2H	4W 2H	4W 3H	4W 3H	4W 4H
	41	41 3/8	4W 1H	4W 1H	4W 1H	4W 1H	4W 1H	4W 2H	4W 2H	4W 3H	4W 3H	4W 4H
	45	45 3/8	4W 1H	4W 1H	4W 1H	4W 1H	4W 1H	4W 2H	4W 2H	4W 3H	4W 3H	4W 4H
	49	49 3/8	4W 1H	4W 1H	4W 1H	4W 1H	4W 1H	4W 2H	4W 2H	4W 3H	4W 3H	4W 4H
	53	53 3/8	4W 1H	4W 1H	4W 1H	4W 1H	4W 1H	4W 2H	4W 2H	4W 3H	4W 3H	4W 4H
	61	61 3/8	5W 1H	5W 1H	5W 1H	5W 1H	5W 1H	5W 2H	5W 2H	5W 3H	5W 3H	5W 4H
	69	69 3/8	6W 1H	6W 1H	6W 1H	6W 1H	6W 1H	6W 2H	6W 2H	6W 3H	6W 3H	6W 4H
	77	77 3/8	7W 1H	7W 1H	7W 1H	7W 1H	7W 1H	7W 2H	7W 2H	7W 3H	7W 3H	7W 4H



CWDT		Frame Height										
		12	14	16	18	20	24	30	36	42	48	
Frame Width	21	21 3/8	2W 1H	2W 1H	2W 1H	2W 1H	2W 1H	2W 2H	2W 2H	2W 3H	2W 3H	2W 4H
	25	25 3/8	2W 1H	2W 1H	2W 1H	2W 1H	2W 1H	2W 2H	2W 2H	2W 3H	2W 3H	2W 4H
	29	29 3/8	2W 1H	2W 1H	2W 1H	2W 1H	2W 1H	2W 2H	2W 2H	2W 3H	2W 3H	2W 4H
	31	31 3/8	3W 1H	3W 1H	3W 1H	3W 1H	3W 1H	3W 2H	3W 2H	3W 3H	3W 3H	3W 4H
	33	33 3/8	3W 1H	3W 1H	3W 1H	3W 1H	3W 1H	3W 2H	3W 2H	3W 3H	3W 3H	3W 4H
	35	35 3/8	3W 1H	3W 1H	3W 1H	3W 1H	3W 1H	3W 2H	3W 2H	3W 3H	3W 3H	3W 4H
	37	37 3/8	3W 1H	3W 1H	3W 1H	3W 1H	3W 1H	3W 2H	3W 2H	3W 3H	3W 3H	3W 4H
	41	41 3/8	4W 1H	4W 1H	4W 1H	4W 1H	4W 1H	4W 2H	4W 2H	4W 3H	4W 3H	4W 4H
	45	45 3/8	4W 1H	4W 1H	4W 1H	4W 1H	4W 1H	4W 2H	4W 2H	4W 3H	4W 3H	4W 4H
	49	49 3/8	4W 1H	4W 1H	4W 1H	4W 1H	4W 1H	4W 2H	4W 2H	4W 3H	4W 3H	4W 4H
	53	53 3/8	4W 1H	4W 1H	4W 1H	4W 1H	4W 1H	4W 2H	4W 2H	4W 3H	4W 3H	4W 4H
	61	61 3/8	5W 1H	5W 1H	5W 1H	5W 1H	5W 1H	5W 2H	5W 2H	5W 3H	5W 3H	5W 4H
	69	69 3/8	6W 1H	6W 1H	6W 1H	6W 1H	6W 1H	6W 2H	6W 2H	6W 3H	6W 3H	6W 4H
	77	77 3/8	7W 1H	7W 1H	7W 1H	7W 1H	7W 1H	7W 2H	7W 2H	7W 3H	7W 3H	7W 4H

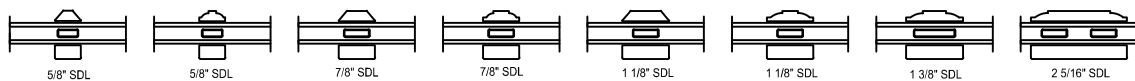

CONTEMPORARY SDL

LITE CUT TABLES - COTTAGE & REVERSED
COTTAGE

COTTAGE DOUBLE HUNG WINDOWS - CWD

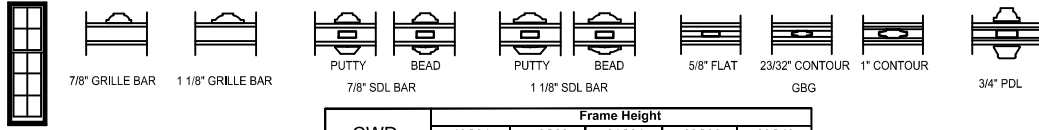

CWD Cottage Sash		Frame Height					
		48C24 48	56C28 56	64C34 64	68C36 68	80C40 80	
Frame Width	21	21 3/8	2W 2H 2H	2W 2H 2H	2W 2H 3H	2W 2H 3H	2W 2H 3H
	25	25 3/8	3W 2H 2H	3W 2H 2H	3W 2H 3H	3W 2H 3H	3W 2H 3H
	29	29 3/8	3W 2H 2H	3W 2H 2H	3W 2H 3H	3W 2H 3H	3W 2H 3H
	31	31 3/8	3W 2H 2H	3W 2H 2H	3W 2H 3H	3W 2H 3H	3W 2H 3H
	33	33 3/8	3W 2H 2H	3W 2H 2H	3W 2H 3H	3W 2H 3H	3W 2H 3H
	35	35 3/8	4W 2H 2H	4W 2H 2H	4W 2H 3H	4W 2H 3H	4W 2H 3H
	37	37 3/8	4W 2H 2H	4W 2H 2H	4W 2H 3H	4W 2H 3H	4W 2H 3H
	41	41 3/8	4W 2H 2H	4W 2H 2H	4W 2H 3H	4W 2H 3H	NA
	45	45 3/8	4W 2H 2H	4W 2H 2H	4W 2H 3H	4W 2H 3H	NA

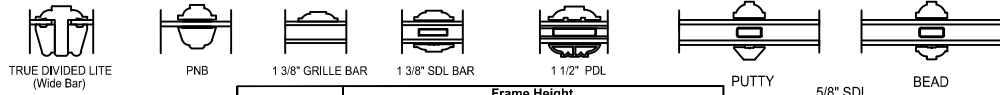

CWD Cottage Sash		Frame Height					
		48C24 48	56C28 56	64C34 64	68C36 68	80C40 80	
Frame Width	21	21 3/8	2W 2H 2H	2W 2H 2H	2W 2H 3H	2W 2H 3H	2W 2H 3H
	25	25 3/8	3W 2H 2H	3W 2H 2H	3W 2H 3H	3W 2H 3H	3W 2H 3H
	29	29 3/8	3W 2H 2H	3W 2H 2H	3W 2H 3H	3W 2H 3H	3W 2H 3H
	31	31 3/8	3W 2H 2H	3W 2H 2H	3W 2H 3H	3W 2H 3H	3W 2H 3H
	33	33 3/8	3W 2H 2H	3W 2H 2H	3W 2H 3H	3W 2H 3H	3W 2H 3H
	35	35 3/8	4W 2H 2H	4W 2H 2H	4W 2H 3H	4W 2H 3H	4W 2H 3H
	37	37 3/8	4W 2H 2H	4W 2H 2H	4W 2H 3H	4W 2H 3H	4W 2H 3H
	41	41 3/8	4W 2H 2H	4W 2H 2H	4W 2H 3H	4W 2H 3H	NA
	45	45 3/8	4W 2H 2H	4W 2H 2H	4W 2H 3H	4W 2H 3H	NA

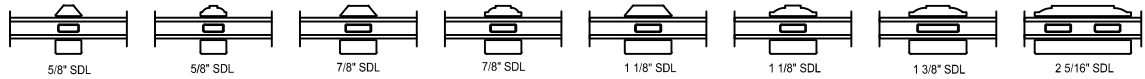

CONTEMPORARY SDL

REVERSE COTTAGE DOUBLE HUNG WINDOWS - CWD

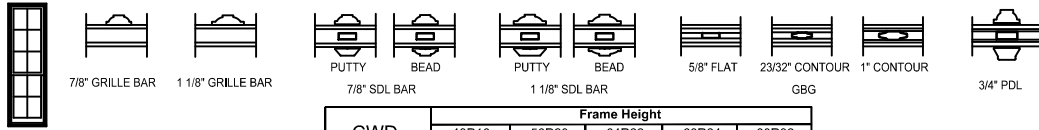

CWD Reverse Cottage Sash		Frame Height					
		48R16 48	56R20 56	64R22 64	68R24 68	80R32 80	
Frame Width	21	21 3/8	2W 2H 2H	2W 2H 2H	2W 3H 2H	2W 3H 2H	2W 3H 2H
	25	25 3/8	3W 2H 2H	3W 2H 2H	3W 3H 2H	3W 3H 2H	3W 3H 2H
	29	29 3/8	3W 2H 2H	3W 2H 2H	3W 3H 2H	3W 3H 2H	3W 3H 2H
	31	31 3/8	3W 2H 2H	3W 2H 2H	3W 3H 2H	3W 3H 2H	3W 3H 2H
	33	33 3/8	3W 2H 2H	3W 2H 2H	3W 3H 2H	3W 3H 2H	3W 3H 2H
	35	35 3/8	4W 2H 2H	4W 2H 2H	4W 3H 2H	4W 3H 2H	4W 3H 2H
	37	37 3/8	4W 2H 2H	4W 2H 2H	4W 3H 2H	4W 3H 2H	4W 3H 2H
	41	41 3/8	4W 2H 2H	4W 2H 2H	4W 3H 2H	4W 3H 2H	NA
	45	45 3/8	4W 2H 2H	4W 2H 2H	4W 3H 2H	4W 3H 2H	NA



CWD Reverse Cottage Sash		Frame Height					
		48R16 48	56R20 56	64R22 64	68R24 68	80R32 80	
Frame Width	21	21 3/8	2W 2H 2H	2W 2H 2H	2W 3H 2H	2W 3H 2H	2W 3H 2H
	25	25 3/8	2W 2H 2H	2W 2H 2H	2W 3H 2H	2W 3H 2H	2W 3H 2H
	29	29 3/8	3W 2H 2H	3W 2H 2H	3W 3H 2H	3W 3H 2H	3W 3H 2H
	31	31 3/8	3W 2H 2H	3W 2H 2H	3W 3H 2H	3W 3H 2H	3W 3H 2H
	33	33 3/8	3W 2H 2H	3W 2H 2H	3W 3H 2H	3W 3H 2H	3W 3H 2H
	35	35 3/8	3W 2H 2H	3W 2H 2H	3W 3H 2H	3W 3H 2H	3W 3H 2H
	37	37 3/8	3W 2H 2H	3W 2H 2H	3W 3H 2H	3W 3H 2H	3W 3H 2H
	41	41 3/8	4W 2H 2H	4W 2H 2H	4W 3H 2H	4W 3H 2H	NA
	45	45 3/8	4W 2H 2H	4W 2H 2H	4W 3H 2H	4W 3H 2H	NA

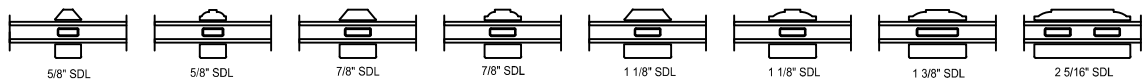

CONTEMPORARY SDL

CLEAR OPENING LAYOUT

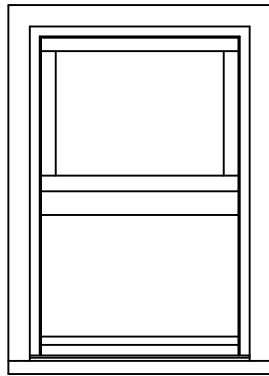
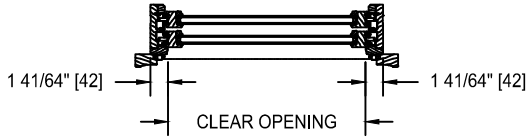

DOUBLE HUNG WINDOW

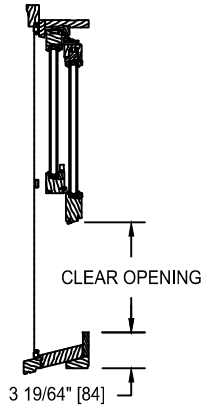

DOUBLE HUNG
CLEAR OPENING FORMULA
INTERIOR GLAZED SASH NON-IMPACT
VERTICAL DP35
(Frame Height / 2) - 4 13/16" = Clear Opening
VERTICAL DP50
(Frame Height / 2) - 5 3/16" = Clear Opening
HORIZONTAL
Frame - 3 9/32" = Clear Opening
EXTERIOR GLAZED SASH
VERTICAL
(Frame Height / 2) - 4 13/16" = Clear Opening
HORIZONTAL
Frame - 3 9/32" = Clear Opening

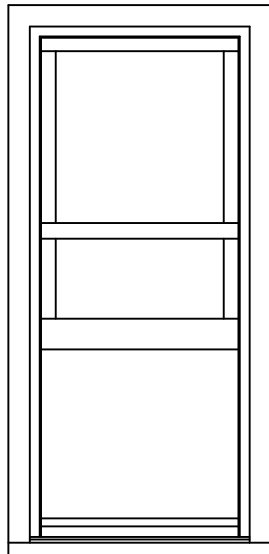
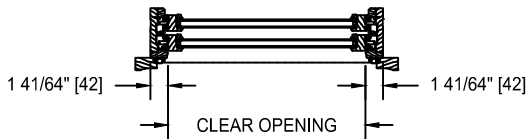

COTTAGE WINDOW

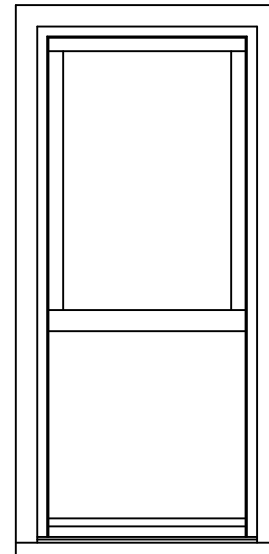
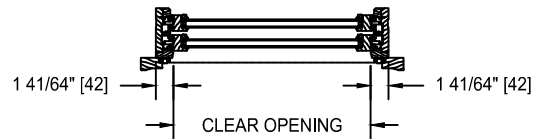

REVERSE COTTAGE WINDOW

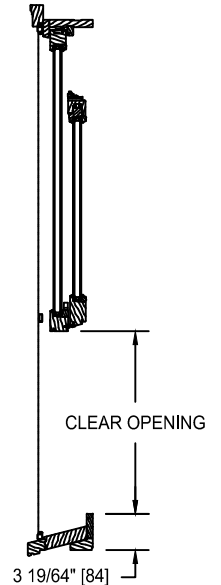
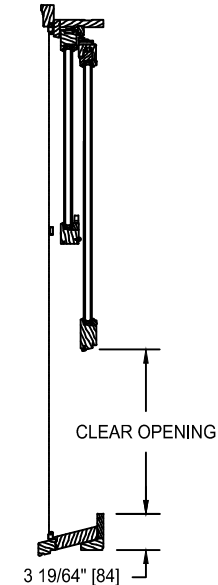

COTTAGE & REVERSE COTTAGE

Consult the Design Data Tables for clear opening information. For dimensional units, contact Jeld-Wen - Bend Window Division Technical Services Department for Clear Opening information.

CLEAR OPENING LAYOUT

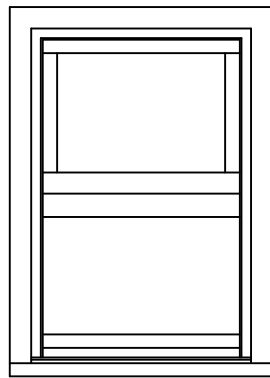
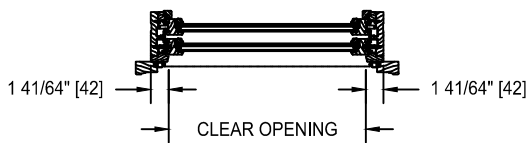

WZ3 IMPACT

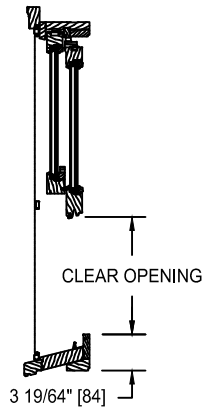

DOUBLE HUNG - WZ3 IMPACT
CLEAR OPENING FORMULA
VERTICAL
 $(\text{Frame Height} / 2) - 5 \frac{3}{16}'' = \text{Clear Opening}$
HORIZONTAL
 $\text{Frame} - 3 \frac{9}{32}'' = \text{Clear Opening}$

HANDING & OPERATION
DOUBLE-HUNG

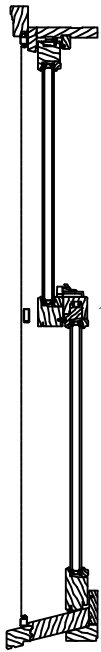

DOUBLE HUNG OPERATION:
When the sash are locked at the check rails the sash are closed and sealed in the sash opening of the frame.

When the sash are unlocked the lower sash travels vertically to any position desired. The upper sash can also be positioned as desired.

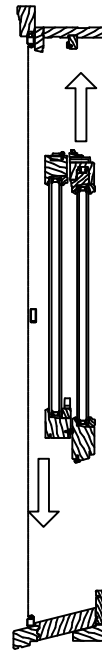

SASH TILTING FOR WASHING

The Custom Double Hung window will allow the sash to be tilted or removed for easy cleaning.

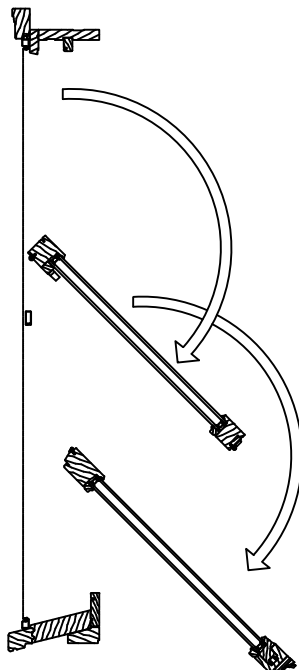

**UNIT SIZING, ROUGH OPENING,
& MASONRY OPENINGS**
DOUBLE-HUNG

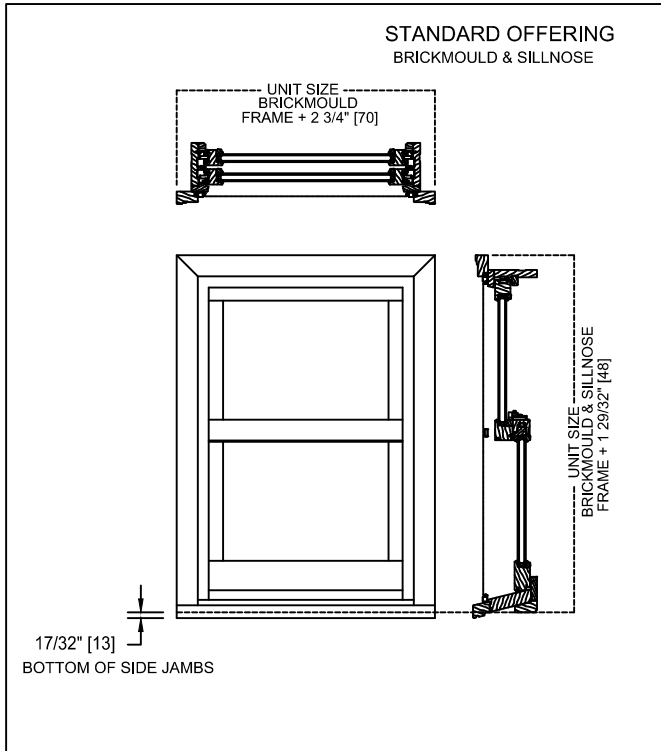

GENERAL NOTES:

UNITS WITH NO TRIM AND SILL NOSE:
UNIT SIZE = FRAME SIZE

UNIT SIZE IS ALWAYS THE
EXTREME SIZE OF THE WINDOW
WITH OR WITHOUT TRIM

MASONRY OPENING:

MASONRY OPENING IS ALWAYS 1/2" OVER
THE UNIT SIZE OF THE WINDOW

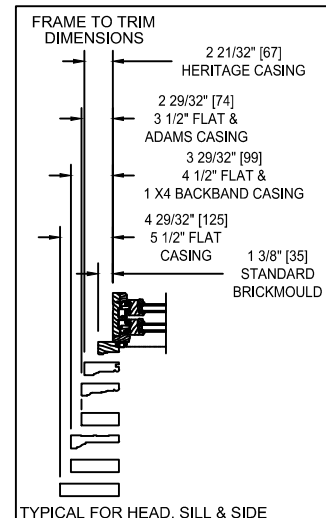
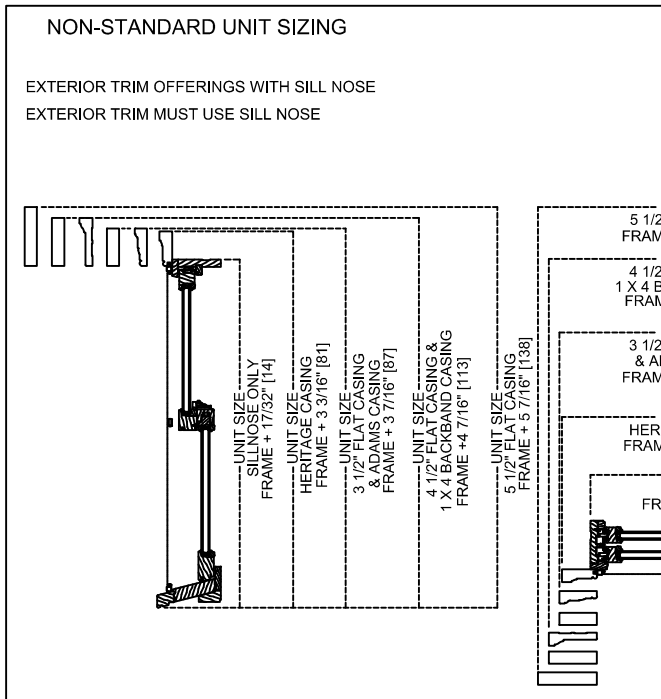
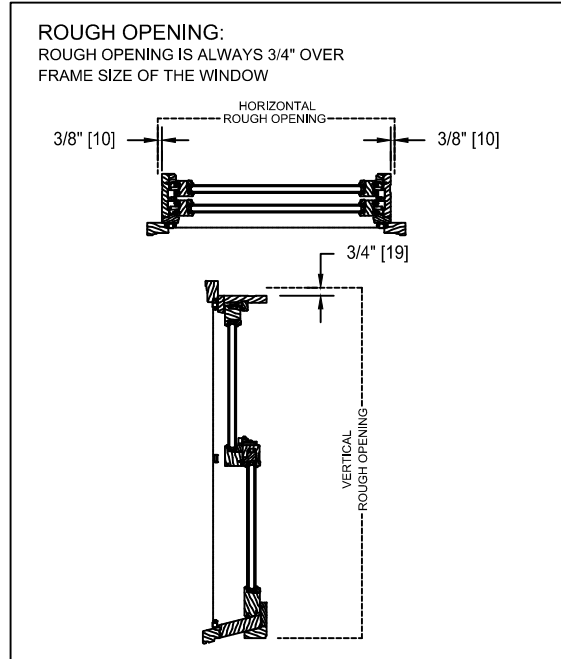

TRIM & SILL OPTIONS
DOUBLE-HUNG

EXTERIOR TRIM

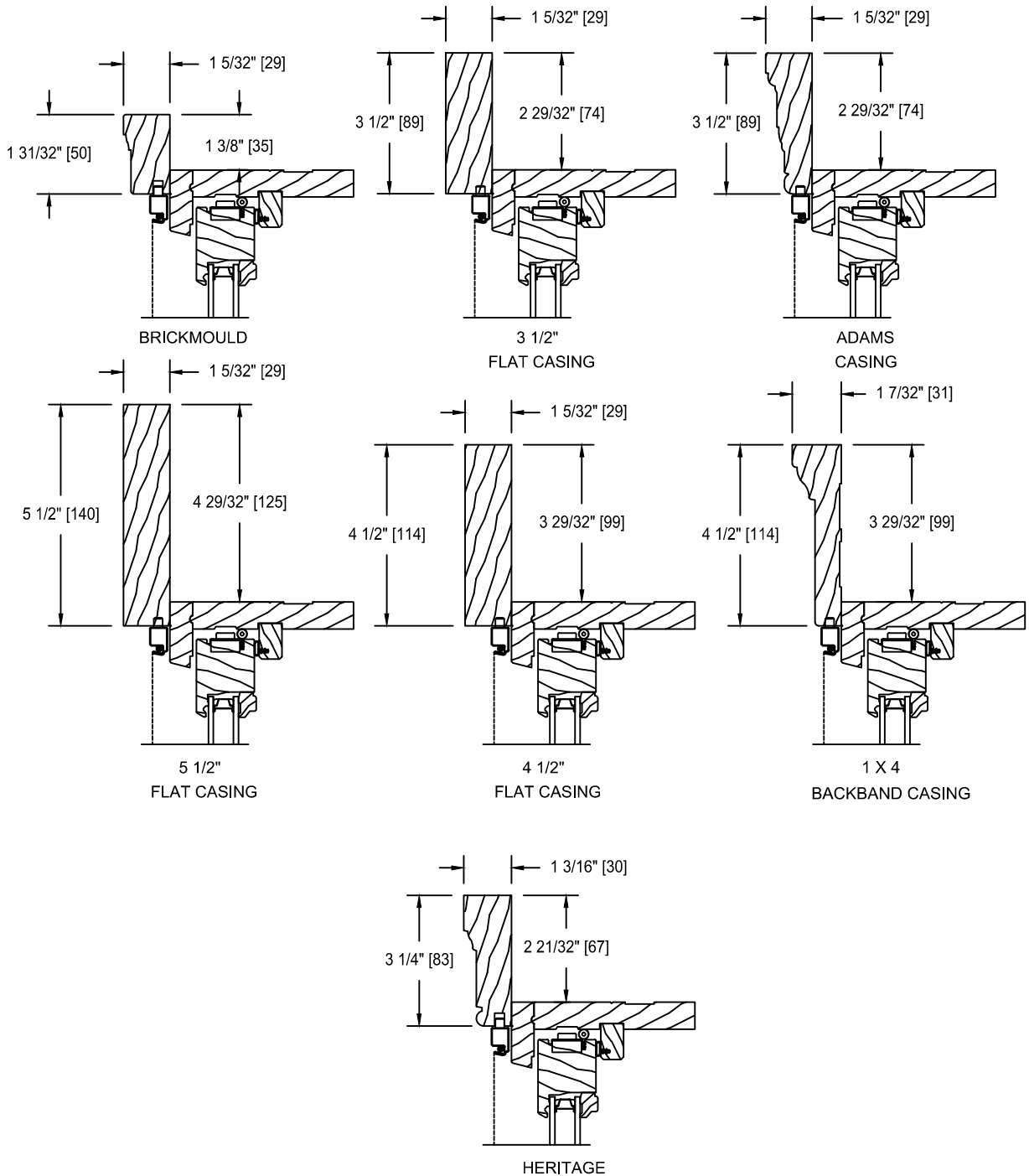

SILL OPTIONS
DOUBLE-HUNG

EXTENDED SILL OPTION

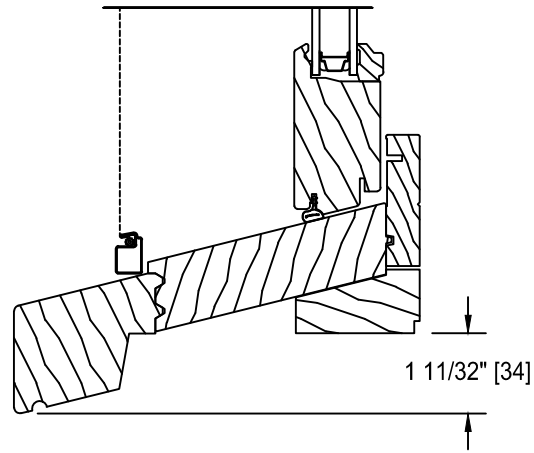

WOOD TWO PIECE
EXTENDED SILL NOSE

STUCCO TRIM OPTION

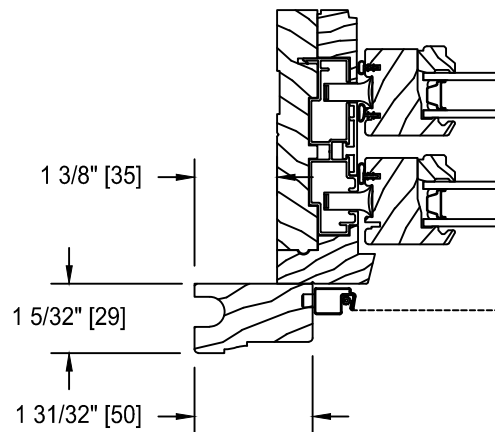

BAY WINDOW HORIZONTAL
SPECIFICATION TABLES

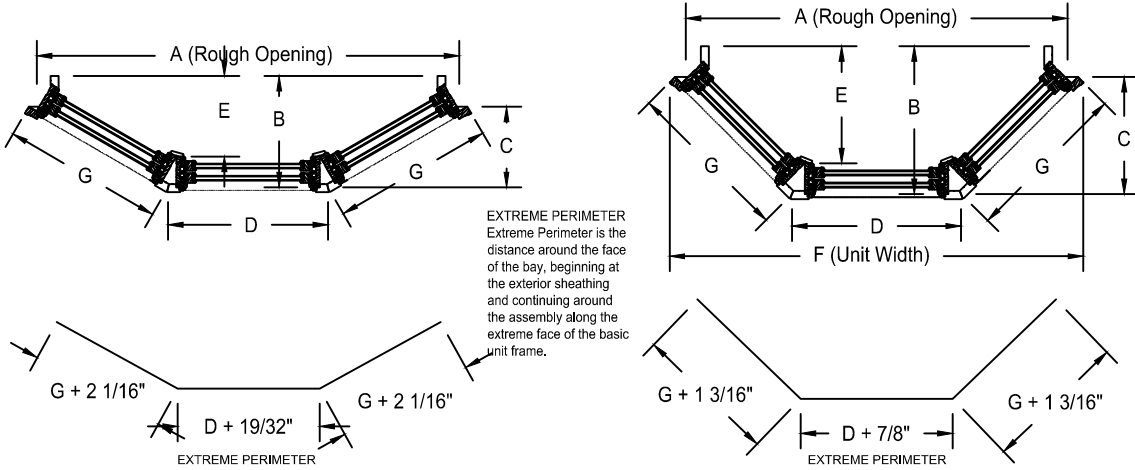

EXTREME PERIMETER
Extreme Perimeter is the distance around the face of the bay, beginning at the exterior sheathing and continuing around the assembly along the extreme face of the basic unit frame.

BOOKCODE NOTE:

CWD3Y2140-21

↑ Flanker Frame Width
↑ Frame Height
↑ Center Frame Width
↑ Degree of Bay Window (3=30°, 4=45°)

30° BAY										
Flanker Width	Center Width	A Rough Opening	F Unit Width	B Overall Projection	C Projection Exterior Wall	E Seating Depth	D Outside Mull To Mull	G Outside Mull To Unit		
21	21	62 15/16	66 7/16	16 9/16	12	12	23 13/16	23 31/32		
21	41	82 15/16	86 7/16	16 9/16	12	12	43 13/16	23 31/32		
21	49	90 15/16	94 7/16	16 9/16	12	12	51 13/16	23 31/32		
21	53	94 15/16	98 7/16	16 9/16	12	12	55 13/16	23 31/32		
21	61	102 15/16	106 7/16	16 9/16	12	12	63 13/16	23 31/32		
21	69	110 15/16	114 7/16	16 9/16	12	12	71 13/16	23 31/32		
25	25	73 7/8	77 3/8	18 9/16	14	14	27 13/16	27 31/32		
25	41	89 7/8	93 3/8	18 9/16	14	14	43 13/16	27 31/32		
25	49	97 7/8	101 3/8	18 9/16	14	14	51 13/16	27 31/32		
25	53	101 7/8	105 3/8	18 9/16	14	14	55 13/16	27 31/32		
25	61	109 7/8	113 3/8	18 9/16	14	14	63 13/16	27 31/32		
25	69	117 7/8	121 3/8	18 9/16	14	14	71 13/16	27 31/32		
29	29	84 13/16	88 5/16	20 9/16	16	16	31 13/16	31 31/32		
29	41	96 13/16	100 5/16	20 9/16	16	16	43 13/16	31 31/32		
29	49	104 13/16	108 5/16	20 9/16	16	16	51 13/16	31 31/32		
29	53	108 13/16	112 5/16	20 9/16	16	16	55 13/16	31 31/32		
29	61	116 13/16	120 5/16	20 9/16	16	16	63 13/16	31 31/32		
29	69	124 13/16	128 5/16	20 9/16	16	16	71 13/16	31 31/32		

45° BAY										
Flanker Width	Center Width	A Rough Opening	F Unit Width	B Overall Projection	C Projection Exterior Wall	E Seating Depth	D Outside Mull To Mull	G Outside Mull To Unit		
21	21	56 7/8	61 5/8	22	17 7/16	17 7/16	25 5/32	24 5/8		
21	41	76 7/8	81 5/8	22	17 7/16	17 7/16	45 5/32	24 5/8		
21	49	84 7/8	89 5/8	22	17 7/16	17 7/16	53 5/32	24 5/8		
21	53	88 7/8	93 5/8	22	17 7/16	17 7/16	57 5/32	24 5/8		
21	61	96 7/8	101 5/8	22	17 7/16	17 7/16	65 5/32	24 5/8		
21	69	104 7/8	109 5/8	22	17 7/16	17 7/16	73 5/32	24 5/8		
25	25	66 1/2	71 9/32	24 13/16	20 1/4	20 1/4	29 5/32	28 5/8		
25	41	82 1/2	87 9/32	24 13/16	20 1/4	20 1/4	45 5/32	28 5/8		
25	49	90 1/2	95 9/32	24 13/16	20 1/4	20 1/4	53 5/32	28 5/8		
25	53	94 1/2	99 9/32	24 13/16	20 1/4	20 1/4	57 5/32	28 5/8		
25	61	102 1/2	107 9/32	24 13/16	20 1/4	20 1/4	65 5/32	28 5/8		
25	69	110 1/2	115 9/32	24 13/16	20 1/4	20 1/4	73 5/32	28 5/8		
29	29	76 3/16	80 15/16	27 5/8	23 3/32	23 3/32	33 5/32	32 5/8		
29	41	88 3/16	92 15/16	27 5/8	23 3/32	23 3/32	45 5/32	32 5/8		
29	49	96 3/16	100 15/16	27 5/8	23 3/32	23 3/32	53 5/32	32 5/8		
29	53	100 3/16	104 15/16	27 5/8	23 3/32	23 3/32	57 5/32	32 5/8		
29	61	108 3/16	112 15/16	27 5/8	23 3/32	23 3/32	65 5/32	32 5/8		
29	69	116 3/16	120 15/16	27 5/8	23 3/32	23 3/32	73 5/32	32 5/8		

4 9/16 and 6 9/16 WALL APPLICATION
The tables above reflect a 4 9/16" wall application. To convert to 6 9/16" wall application add 2" to the figures in the columns which show an asterisk (*), B and E.

GLAZING OPTIONS
DOUBLE-HUNG
INTERIOR GLAZED
INSULATED 3/4" [19] GLASS

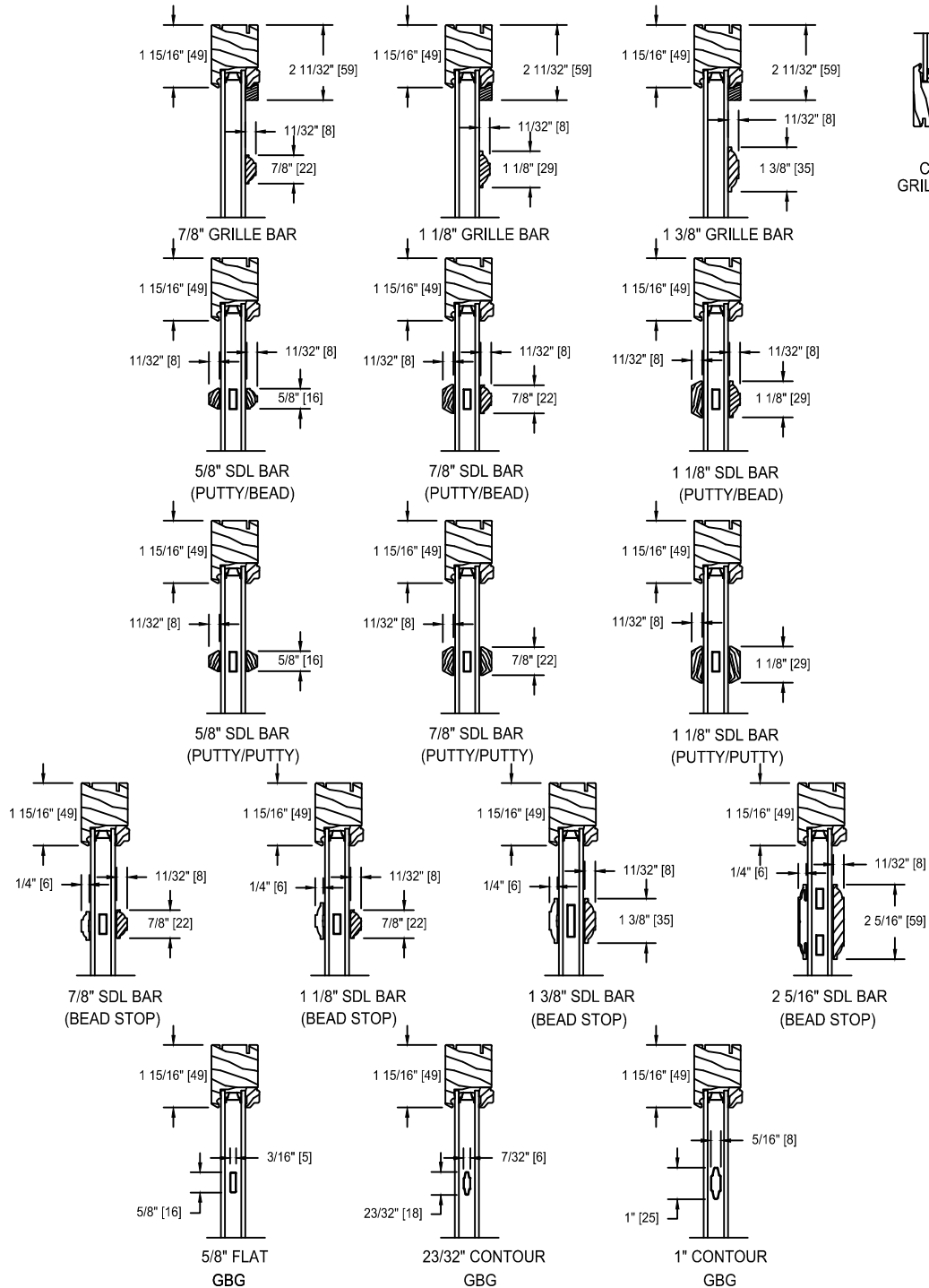

GLAZING OPTIONS
DOUBLE-HUNG
INTERIOR GLAZED
SINGLE GLAZED 1/8" [3] GLASS

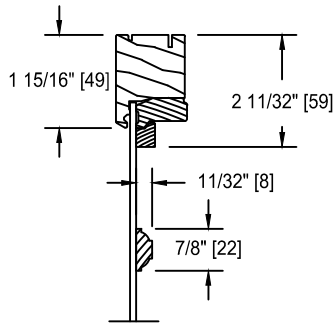

7/8" GRILLE BAR

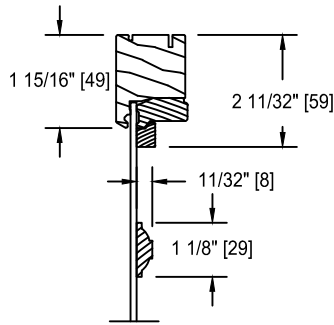

1 1/8" GRILLE BAR

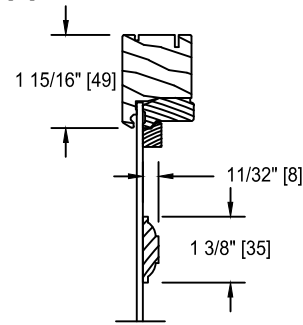

1 3/8" GRILLE BAR



CHECK RAIL
GRILLE SURROUND

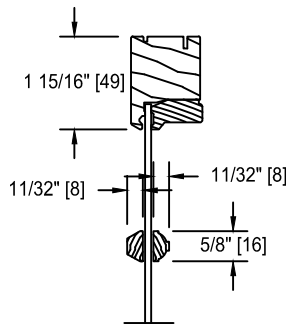

5/8" SDL
(PUTTY/BEAD)

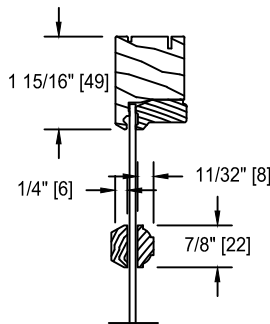

7/8" SDL
(PUTTY/BEAD)

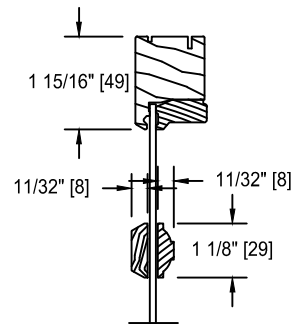

1 1/8" SDL
(PUTTY/BEAD)

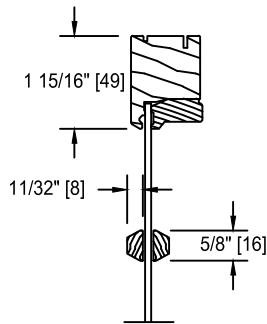

5/8" SDL
(PUTTY/PUTTY)

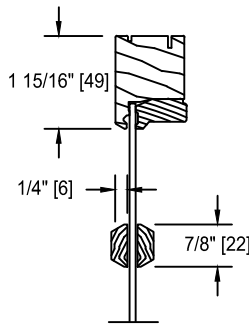

7/8" SDL
(PUTTY/PUTTY)

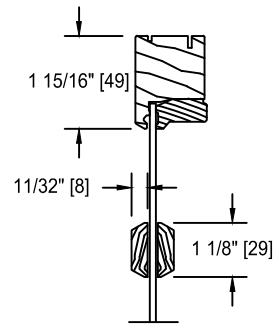

1 1/8" SDL
(PUTTY/PUTTY)

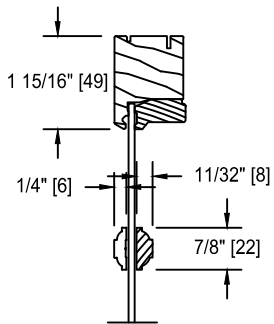

7/8" SDL
(BEAD STOP)

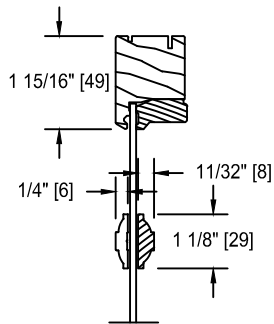

1 1/8" SDL
(BEAD STOP)

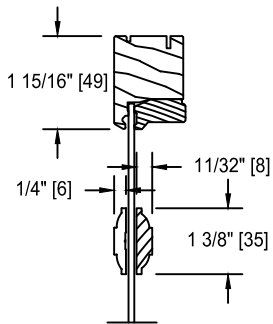

1 3/8" SDL
(BEAD STOP)

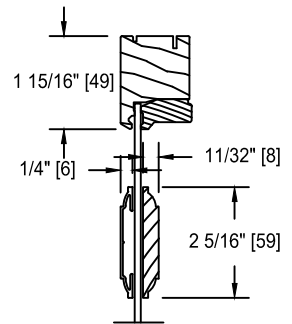

2 5/16" SDL BAR
(BEAD STOP)

GLAZING OPTIONS
DOUBLE-HUNG
INTERIOR GLAZED
MONOLITHIC IMPACT RESISTANT GLASS

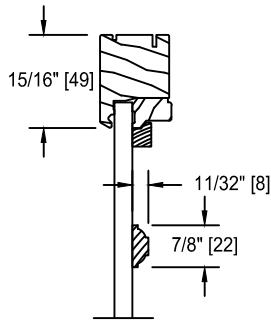

7/8" GRILLE BAR

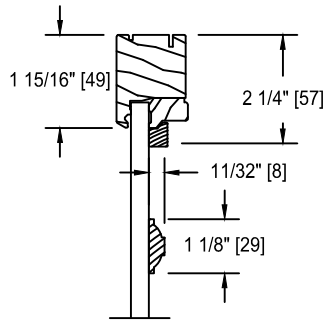

1 1/8" GRILLE BAR

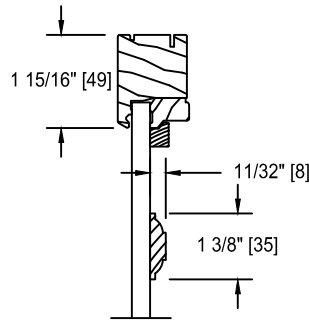

1 3/8" GRILLE BAR

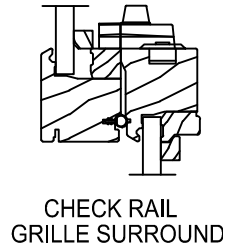

CHECK RAIL
GRILLE SURROUND

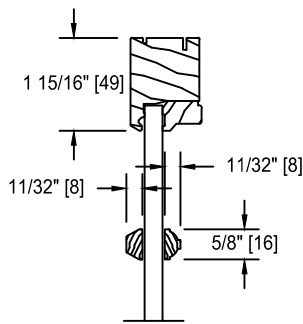

5/8" SDL
(PUTTY/BEAD)

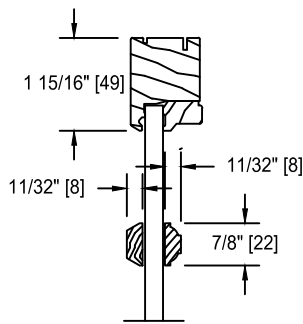

7/8" SDL
(PUTTY/BEAD)

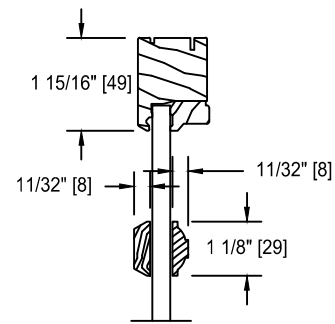

1 1/8" SDL
(PUTTY/BEAD)

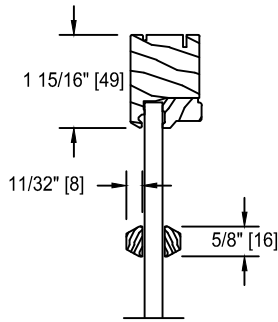

5/8" SDL
(PUTTY/PUTTY)

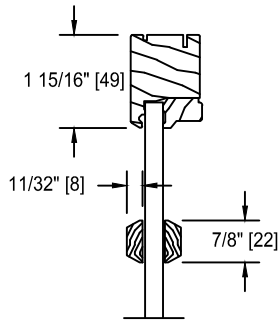

7/8" SDL
(PUTTY/PUTTY)

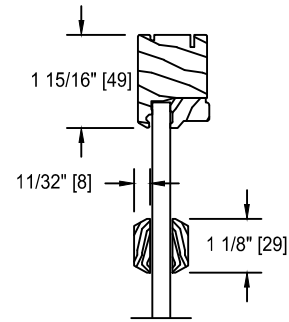

1 1/8" SDL
(PUTTY/PUTTY)

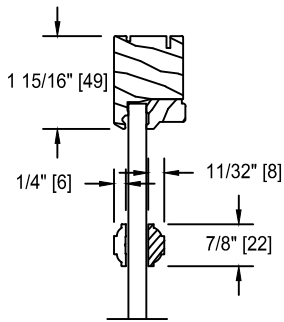

7/8" SDL
(BEAD STOP)

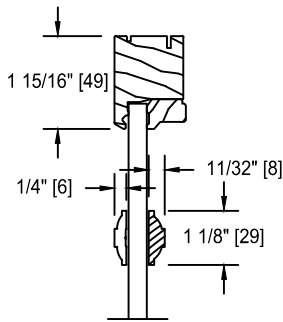

1 1/8" SDL
(BEAD STOP)

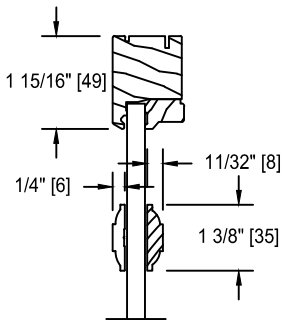

1 3/8" SDL
(BEAD STOP)

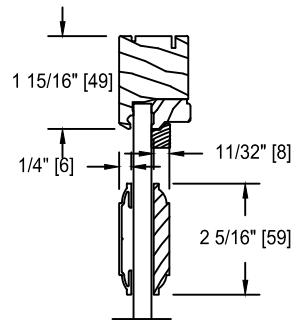

2 5/16" SDL BAR
(BEAD STOP)

GLAZING OPTIONS
DOUBLE-HUNG
INTERIOR GLAZED
MONOLITHIC IMPACT RESISTANT GLASS

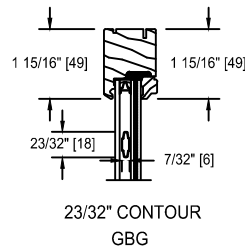
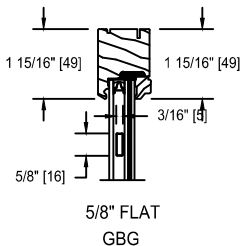
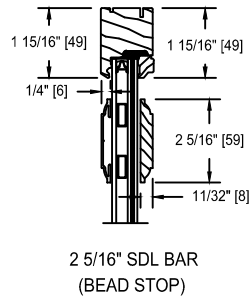
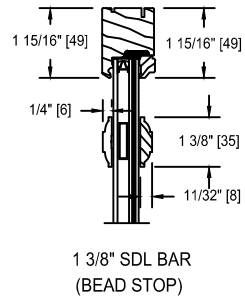
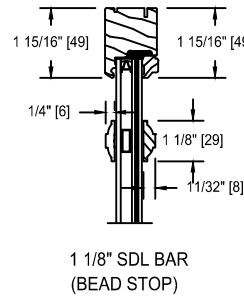
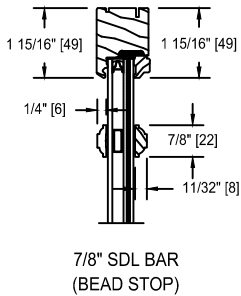
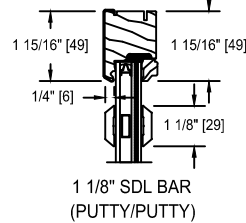
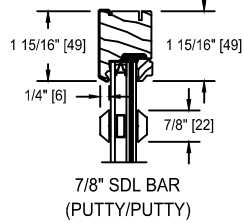
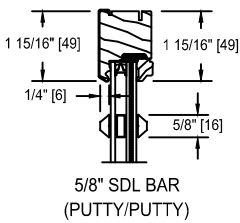
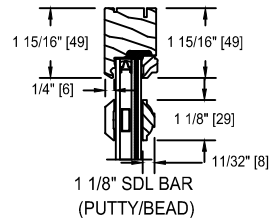
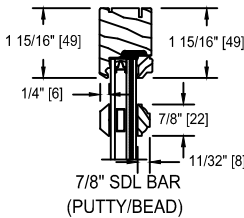
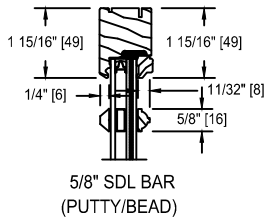
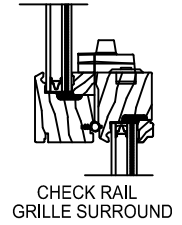
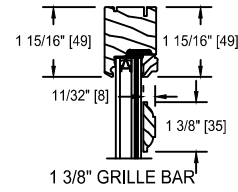
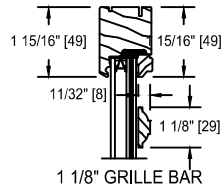
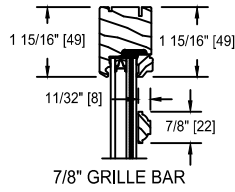

GLAZING OPTIONS
DOUBLE-HUNG
EXTERIOR GLAZED

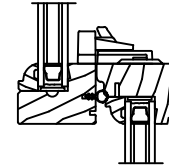
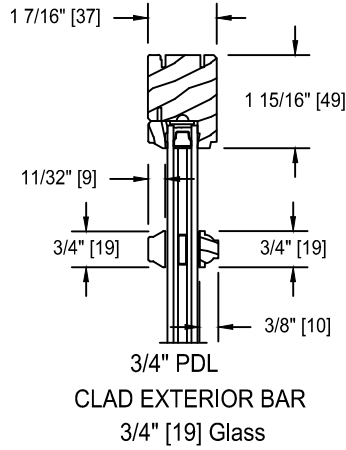
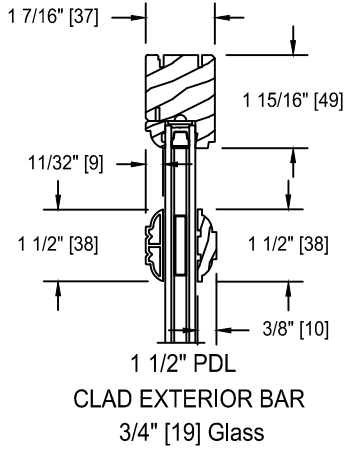

CHECK RAIL
1 1/2" PDL

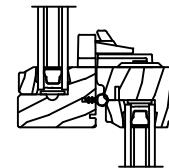
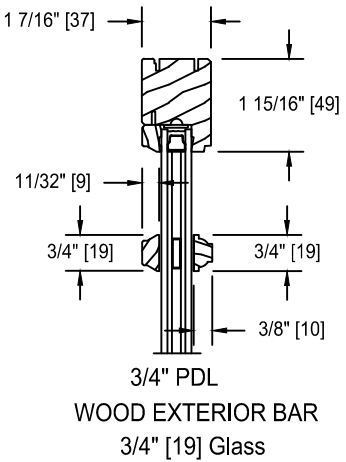
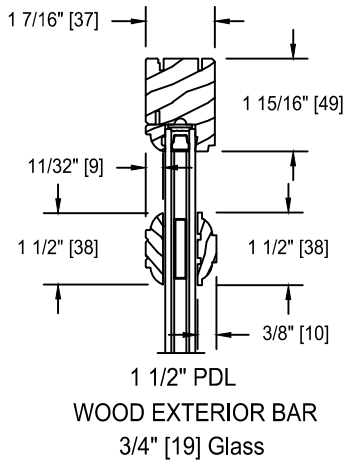

CHECK RAIL
3/4" PDL

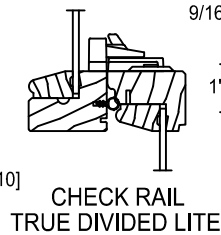
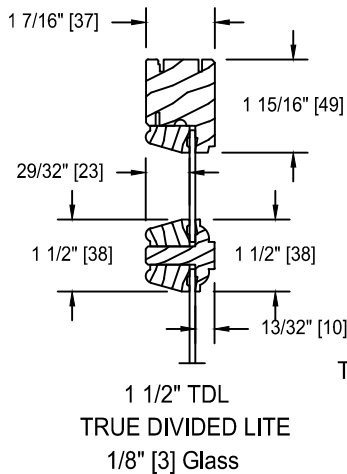

CHECK RAIL
TRUE DIVIDED LITE

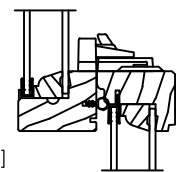
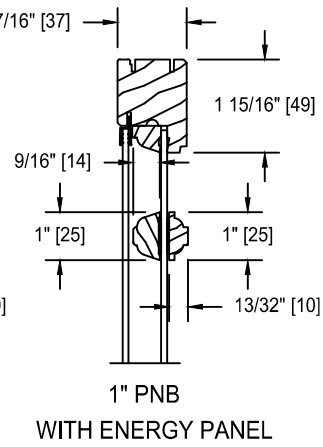
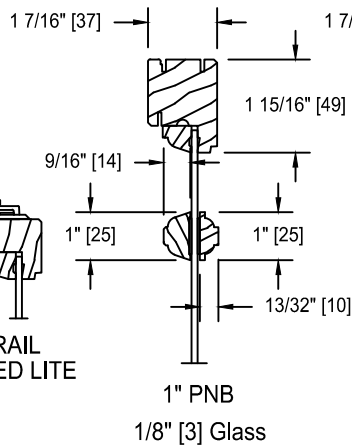

PNB CHECK RAIL

JAMB EXTENDER & STOOL OPTIONS

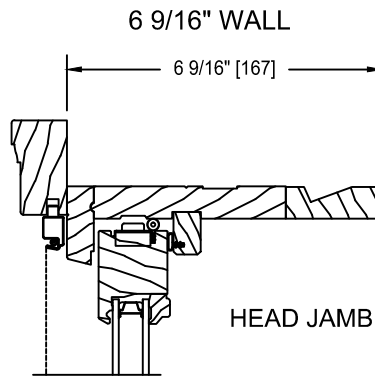
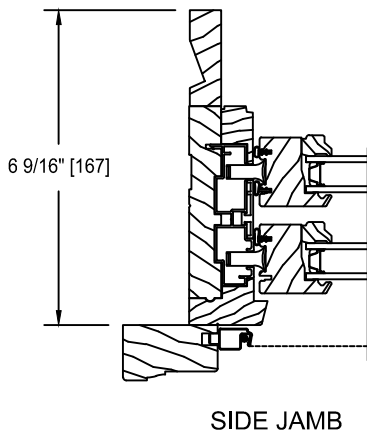

STANDARD 4/4
JAMB EXTENDER

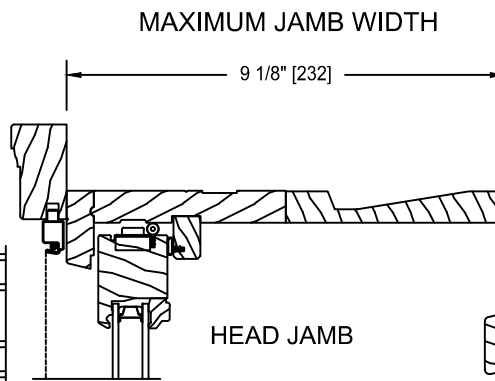
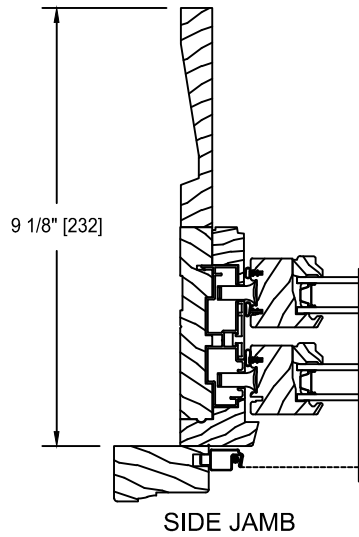
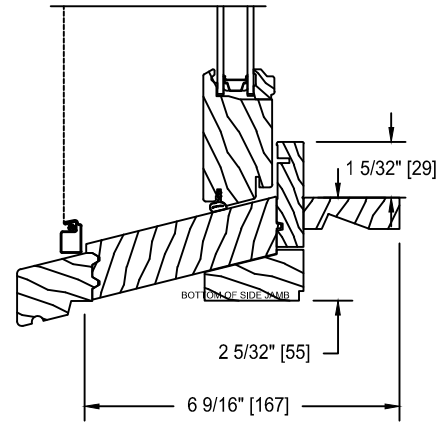

STANDARD 4/4
JAMB EXTENDER

STOOL OPTIONS

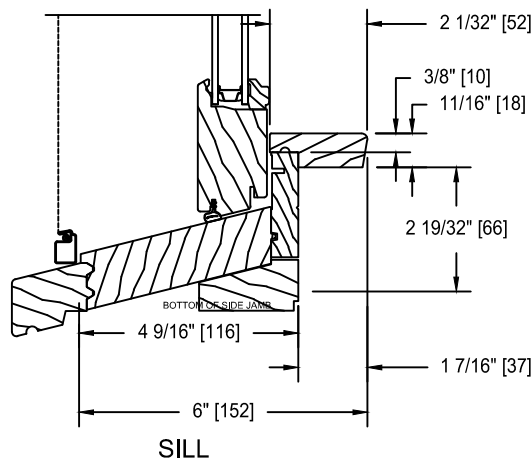
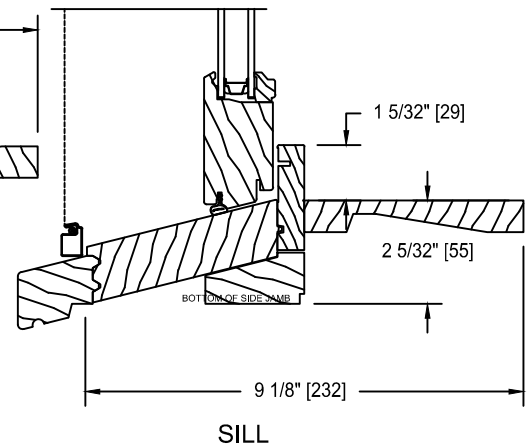

2" STOOL

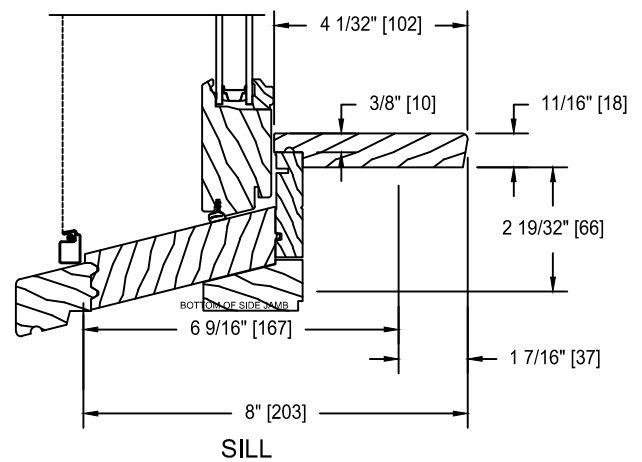

4" STOOL

STANDARD MULLION DETAILS

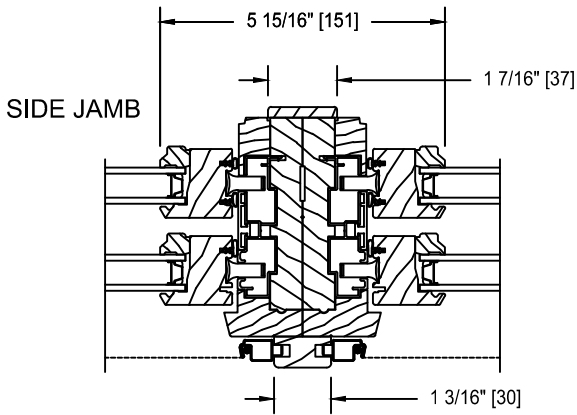

DOUBLE HUNG NEXT
TO A DOUBLE HUNG

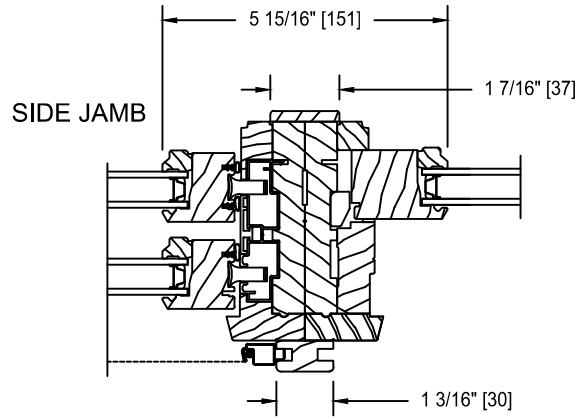

DOUBLE HUNG NEXT
TO A PICTURE UNIT

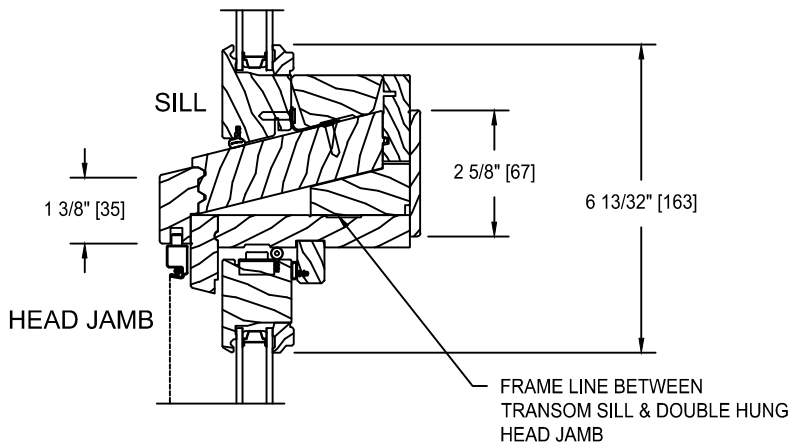

TRANSOM OVER
A DOUBLE HUNG

TRANSOM MULLING NOTE:
Transom units are assembled with the side jamb of the Transom unit flush with the head jamb of the lower unit. The overall vertical frame height of the mullied units is equal to the frame height of the lower unit and the upper unit added together.

SPECIALTY TRIM & MULLION DETAILS
CUSTOM WOOD DOUBLE-HUNG & HORIZONTAL
GLIDING WINDOWS

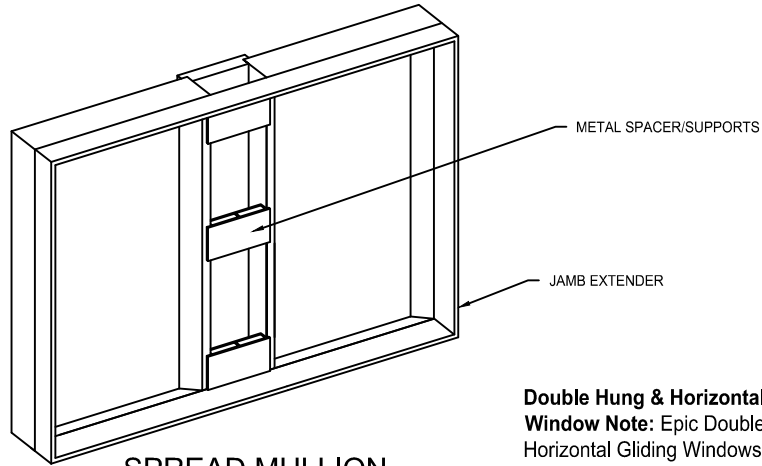

JAMB EXTENDER NOTE:
ONLY 2" 4/4 JAMB EXTENDERS
CAN BE USED

**Double Hung & Horizontal Gliding
Window Note:** Epic Double Hungs &
Horizontal Gliding Windows utilize the
same accessories & configurations.

SPREAD MULLION
VIEWED FROM INTERIOR

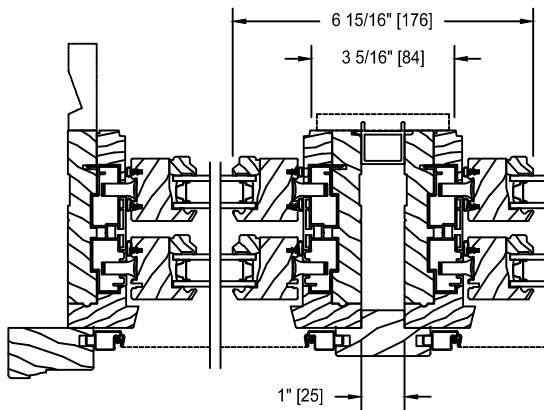

1" SPREAD MULLION

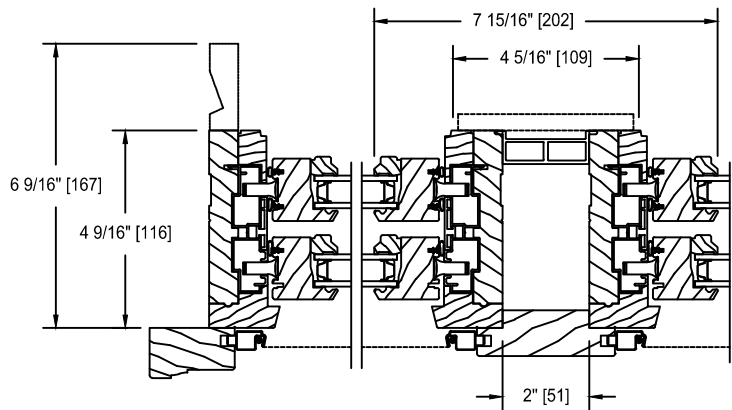

2" SPREAD MULLION

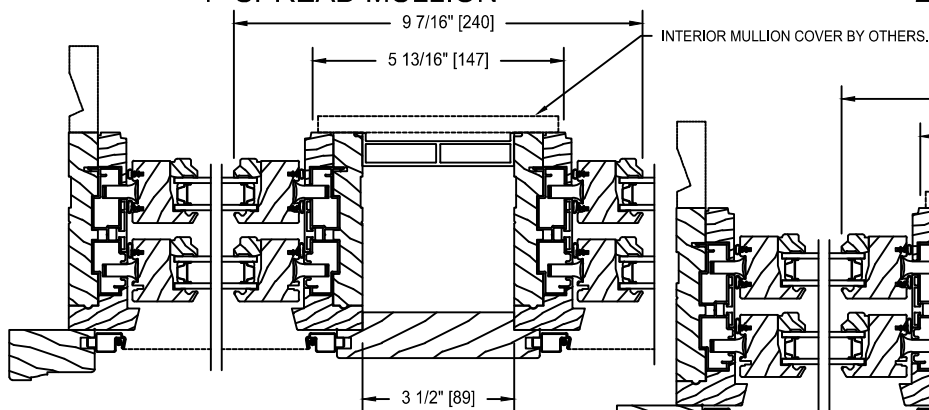

3 1/2" SPREAD MULLION

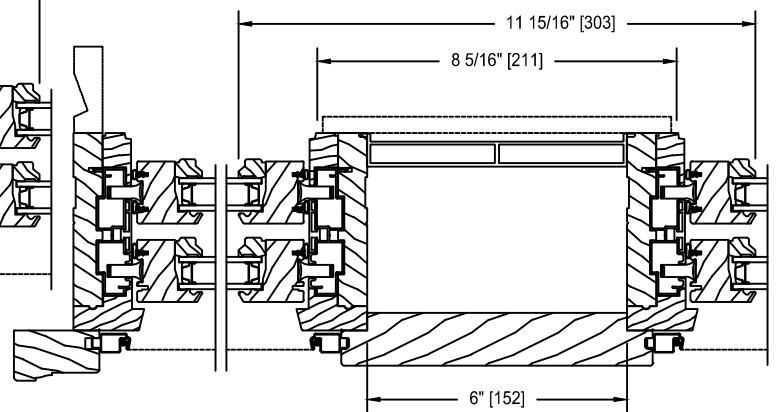

6" SPREAD MULLION

SPECIALTY TRIM & MULLION DETAILS
CUSTOM WOOD DOUBLE-HUNG & HORIZONTAL
GLIDING WINDOWS

STUD POCKET MULLION
VIEWED FROM INTERIOR

JAMB EXTENDER NOTE:
ONLY 2" 4/4 JAMB EXTENDERS
CAN BE USED

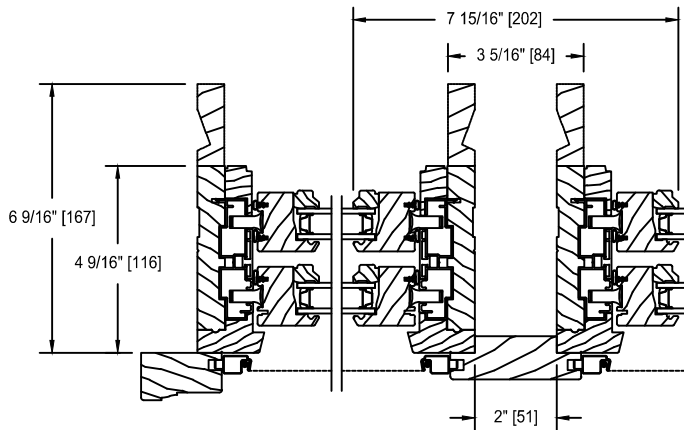
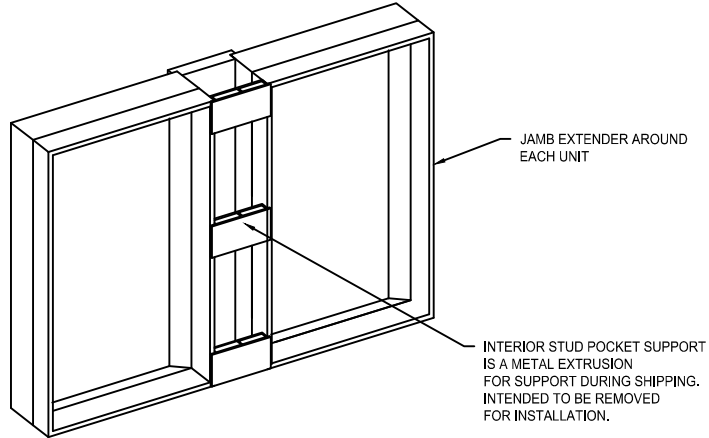

Double Hung & Horizontal Gliding Window Note: Epic Double Hungs & Horizontal Gliding Windows utilize the same accessories & configurations.

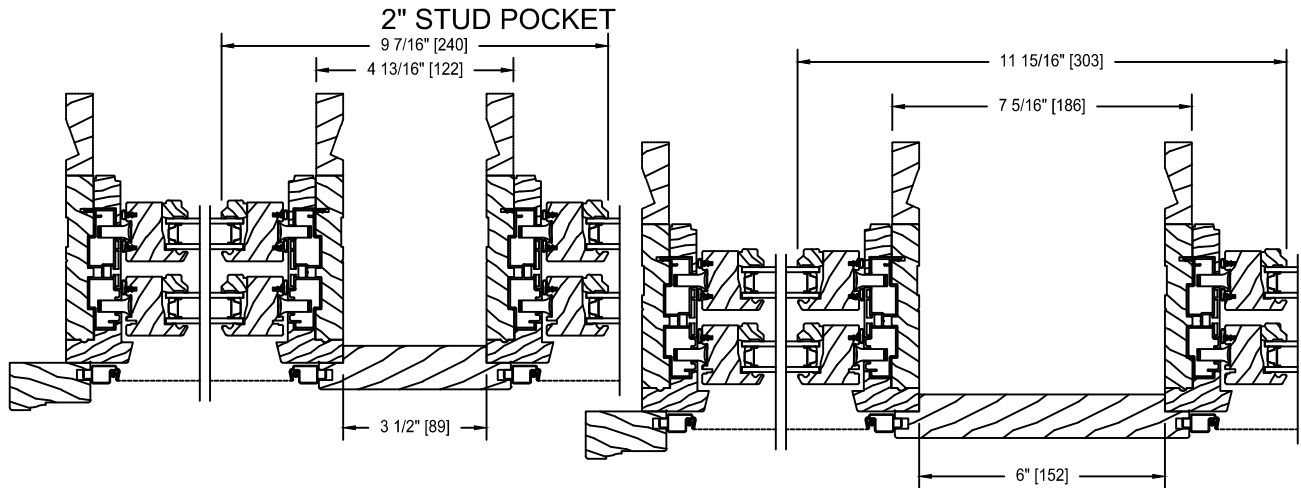

3 1/2" STUD POCKET

6" STUD POCKET

BAY WINDOW ROUGH OPENINGS

BAY WINDOW TRIM OPTIONS

The standard offerings for wood double hung bay windows is 'frame only' and brickmould and sillnose. Other trim options subject to approval.

VERTICAL ROUGH OPENING

Rough Opening typical for all Units

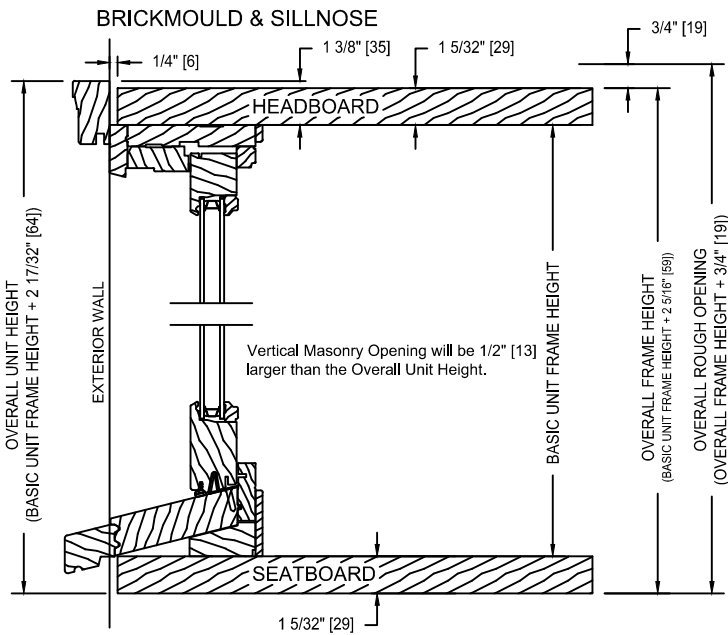
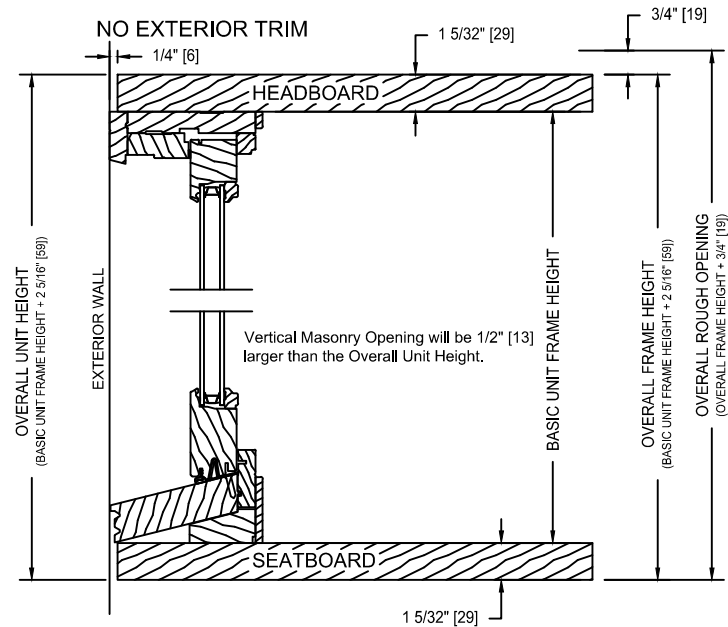

HORIZONTAL ROUGH OPENING

Rough Opening typical for all Units

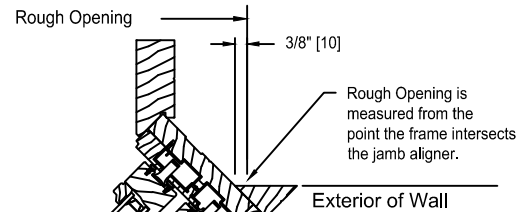

30° & 45° BAYS
45° Bay Shown without trim

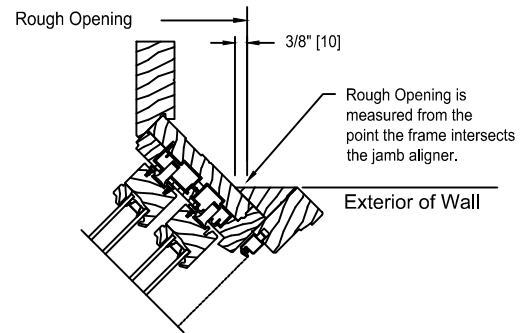

30° & 45° BAYS
45° Bay Shown with Brickmould

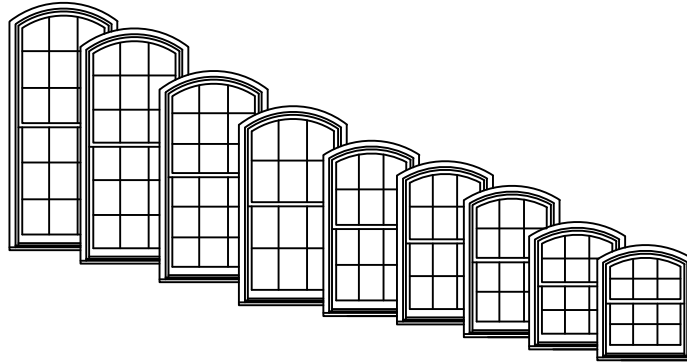

DIMENSIONAL WINDOWS

Wood double hung windows may be specified as "dimensional", by adjusting the desired rough opening width or height in 1/16" increments from standard.

Wood double hung windows feature stationary (fixed) upper sash and an operating lower sash. Counterbalancing is achieved with block and tackle spring extension systems hidden in weatherable PVC jambliners. Operating units are supplied with cam style sash locks which control the concealed tilt latch system at the meeting rails. Combined with the recessed tilt latches in the upper sash, both sash can easily be removed or installed in the field. Exposed tilt latches are optional with the "old style" meeting rail configuration. There are several hardware finish options. Refer to the Specifications for available finish options.

CUSTOM WOOD SECTOR TOP SINGLE HUNG WINDOWS utilize some of the same options as CUSTOM WOOD DOUBLE HUNG.

Those options have not been repeated here in this sub-section.

See the CUSTOM WOOD DOUBLE HUNG section for:
Trim Options (all wood exterior trim is available as radius trim)
Jamb Extender Options

GENERAL NOTES
SECTOR TOP SINGLE-HUNG UNITS

ELEVATION DRAWINGS UTILIZE A LIMITED NUMBER OF PROJECTED LINES TO PRODUCE A RUDIMENTARY DRAWING INTENDED TO BE USED IN A SMALL GRAPHICAL SCALE. ELEVATIONS ARE VIEWED PERPENDICULAR FROM THE EXTERIOR OF THE STRUCTURE. IF MORE DIMENSIONS ARE NEEDED, USE THE SECTION DRAWINGS FOR MORE COMPLETE DEPICTIONS.

SINGLE HUNG WINDOW

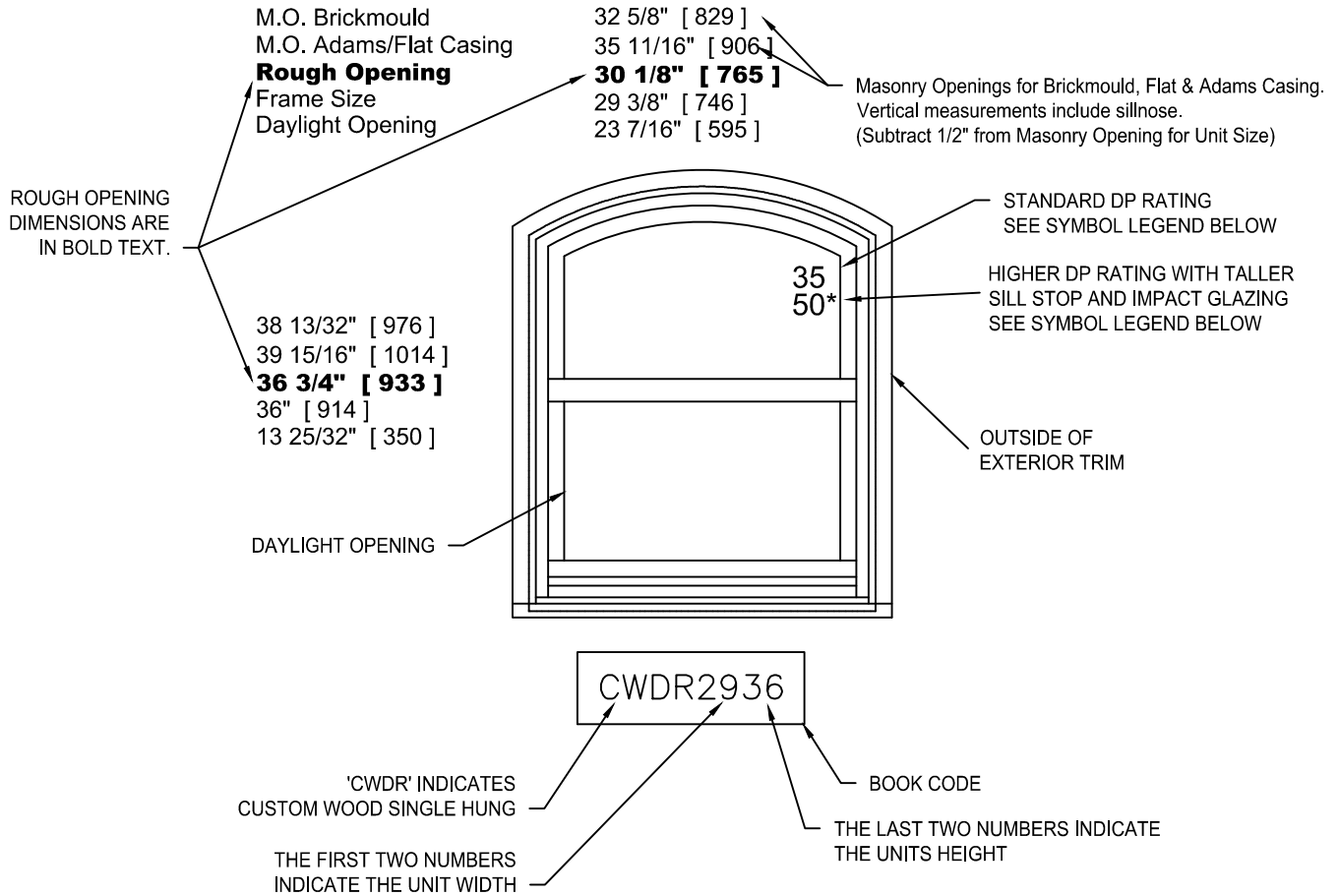

GENERAL WOOD SINGLE HUNG NOTES

1. ALL UNITS SHOWN ARE AVAILABLE AS OPERATORS ONLY.
2. UNIT ELEVATIONS ARE SHOWN WITH BRICKMOULD & SUBSILL.
3. ALL OPERATING SASH ARE INSTALLED WITH VINYL JAMB LINERS AND OPERATED WITH AN INTERNAL BLOCK AND TACKLE SPRING SYSTEM.
4. DIMENSIONAL VALUES IN BRACKETS ARE MILLIMETER CONVERSIONS.

ELEVATION SYMBOL LEGEND:

- E** UNIT MEETS EGRESS REQUIREMENT FOR IRC CODE. STATE AND LOCAL EGRESS CODES MAY DIFFER. ALWAYS REFER TO LOCAL BUILDING CODES FOR COMPLETE REQUIREMENTS. CHECK WITH LOCAL OFFICIALS TO ENSURE COMPLIANCE BEFORE INSTALLING THE UNIT.
- E1** BASIC UNIT CLEAR OPENING EXCEEDS 20" IN WIDTH, 24" IN HEIGHT & A MINIMUM OF 5.0 SQ. FT., FOR FIRST FLOOR EGRESS.
- T** BASIC UNIT IS NOT AVAILABLE WITH TRI-PANE GLASS.
- ##** NUMBER INDICATES DESIGN PRESSURE (DP) RATING WITH STANDARD GLAZING.
- ##*** NUMBER INDICATES HIGHER DP RATING, TALLER SILL STOP AND IMPACT GLAZING.

CLEAR OPENING LAYOUT
SECTOR TOP SINGLE-HUNG UNITS

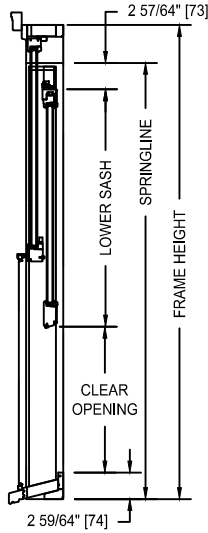
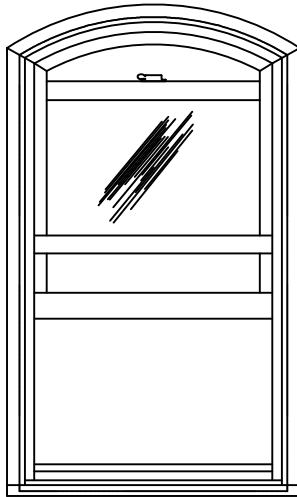
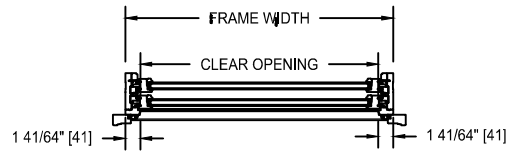
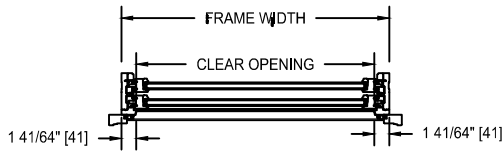

CWDS2952

CONCEALED TILT LATCH
STANDARD BTM RAIL

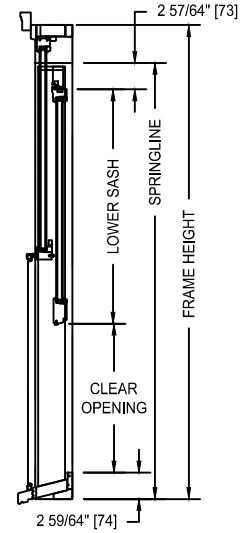
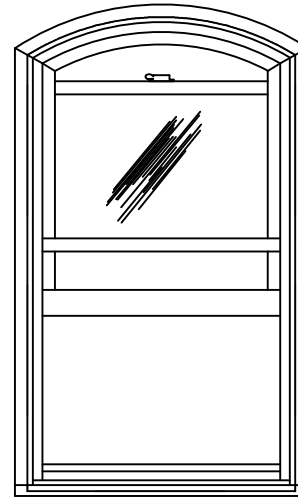

CWDS2952

EXPOSED TILT LATCH
STANDARD BTM RAIL

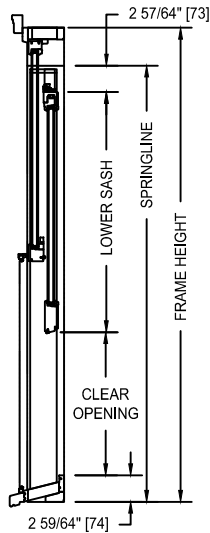
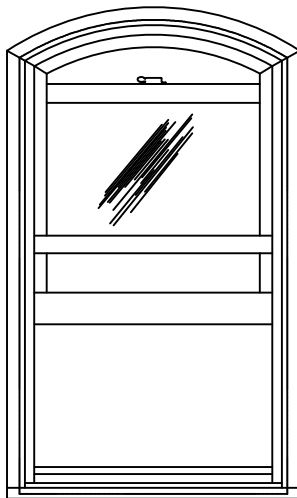
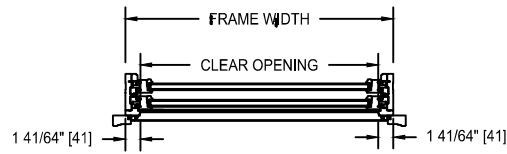
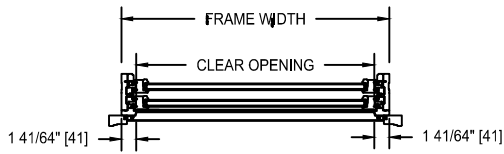

CWDS2952

CONCEALED TILT LATCH
3-1/2" BTM RAIL

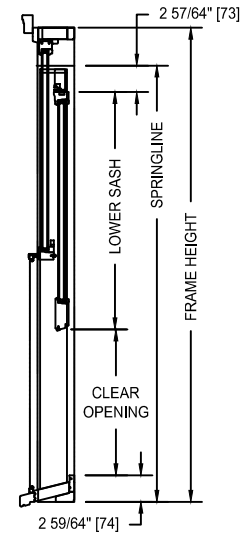
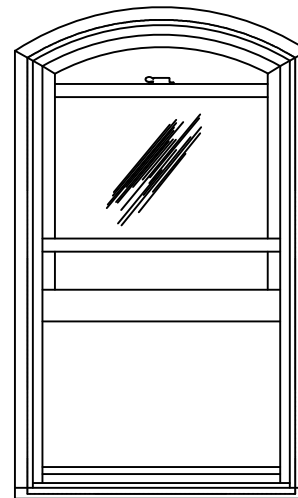

CWDS2952

EXPOSED TILT LATCH
3-1/2" BTM RAIL

CLEAR OPENING LAYOUT
SECTOR TOP SINGLE-HUNG UNITS

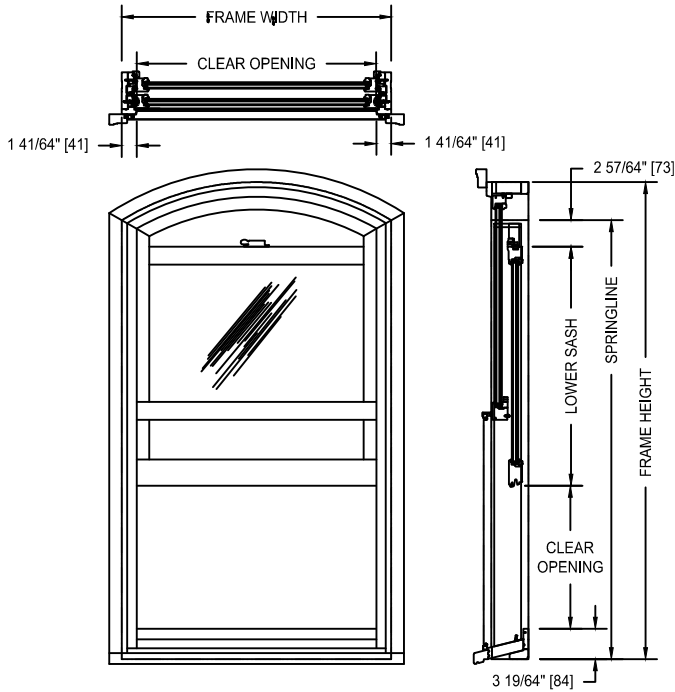

CWDS2952

WZ3 - IMPACT SH (DP-50)
STANDARD BTM RAIL

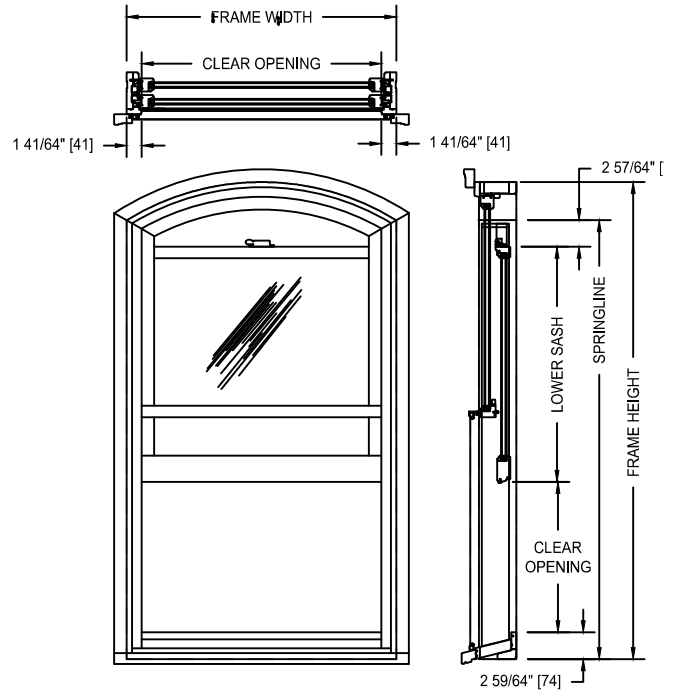

CWDS2952

EXTERIOR GLAZE
STANDARD BTM RAIL

Lower Sash Height						
Frame Ht Callout	CTL Sash Std Btm Rail	ETL Sash Std Btm Rail	CTL Sash 3.5 Btm Rail	ETL Sash 3.5 Btm Rail	EG Sash Std Btm Rail	Impact Sash Std Btm Rail
36	18 1/32	17 23/32	18 11/32	18 1/32	17 5/8	17 31/32
40	20 1/32	19 23/32	20 11/32	20 1/32	19 5/8	19 31/32
44	22 1/32	21 23/32	22 11/32	22 1/32	21 5/8	21 31/32
48	24 1/32	23 23/32	24 11/32	24 1/32	23 5/8	23 31/32
52	26 1/32	25 23/32	26 11/32	26 1/32	25 5/8	25 31/32
56	28 1/32	27 23/32	28 11/32	28 1/32	27 5/8	27 31/32
60	30 1/32	29 23/32	30 11/32	30 1/32	29 5/8	29 31/32
64	32 1/32	31 23/32	32 11/32	32 1/32	31 5/8	31 31/32
68	34 1/32	33 23/32	34 11/32	34 1/32	33 5/8	33 31/32
72	36 1/32	35 23/32	36 11/32	36 1/32	35 5/8	35 31/32
76	38 1/32	37 23/32	38 11/32	38 1/32	37 5/8	37 31/32
80	40 1/32	39 23/32	40 11/32	40 1/32	39 5/8	39 31/32

CTL = Concealed Tilt Latch
ETL = Exposed Tilt Latch
EG = Exterior Glaze
Impact = WZ3 Impact

EXTERIOR GLAZED SINGLE HUNG NON-IMPACT
CLEAR OPENING FORMULA

VERTICAL

Springline - (Lower Sash + 5 13/16") = Clear Opening

HORIZONTAL

Frame - 3 9/32" = Clear Opening

WZ3 IMPACT SINGLE HUNG
CLEAR OPENING FORMULA

VERTICAL

Springline - (Lower Sash + 6 3/16") = Clear Opening

HORIZONTAL

Frame - 3 9/32" = Clear Opening

WOOD SINGLE HUNG - NON-IMPACT
CLEAR OPENING FORMULA

VERTICAL - DP-35

Springline - (Lower Sash + 5 13/16") = Clear Opening

VERTICAL - DP-50

Springline - (Lower Sash + 6 3/16") = Clear Opening

HORIZONTAL

Frame - 3 9/32" = Clear Opening

HANDING & OPERATION
SECTOR TOP SINGLE-HUNG UNITS

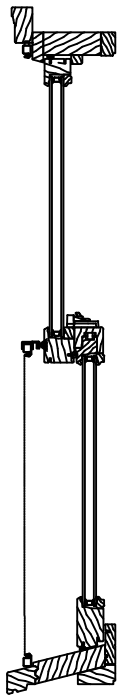

SINGLE HUNG OPERATION:
When the sash are locked at the check rails the sash are closed and sealed in the sash opening of the frame.

When the sash are unlocked the lower sash travels vertically to any position desired. The upper sash is fixed.

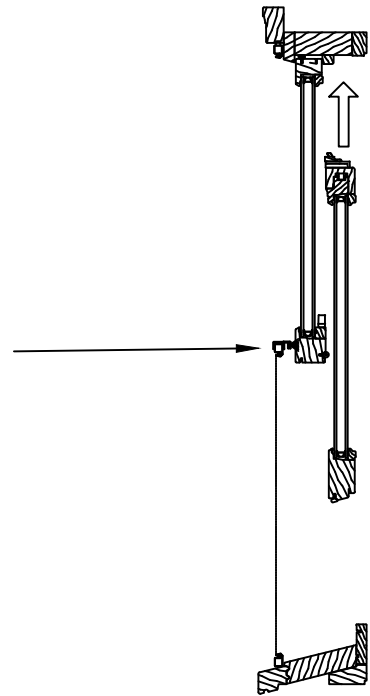

SASH TILTING FOR WASHING

The Custom Wood Single Hung window will allow the lower sash to be tilted or removed for easy cleaning.

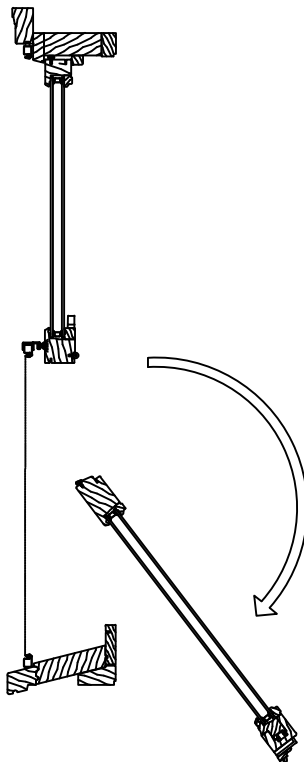

UNIT SIZE, ROUGH OPENINGS & MASONRY OPENINGS
SECTOR TOP SINGLE-HUNG UNITS

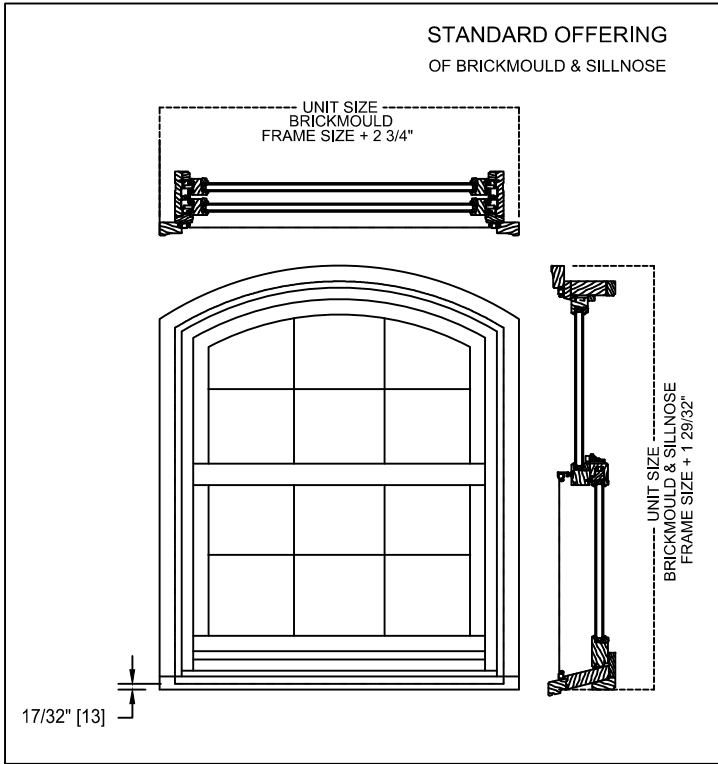

GENERAL NOTES:

UNITS WITH NO TRIM AND SILL NOSE:
UNIT SIZE = FRAME SIZE
UNIT SIZE IS ALWAYS THE
EXTREME SIZE OF THE WINDOW
WITH OR WITHOUT TRIM

MASONRY OPENING:
MASONRY OPENING IS ALWAYS 1/2" OVER
THE UNIT SIZE OF THE WINDOW

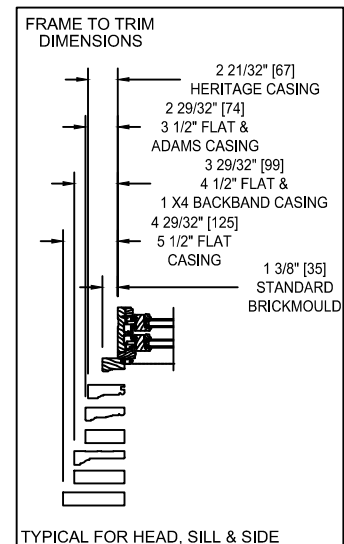
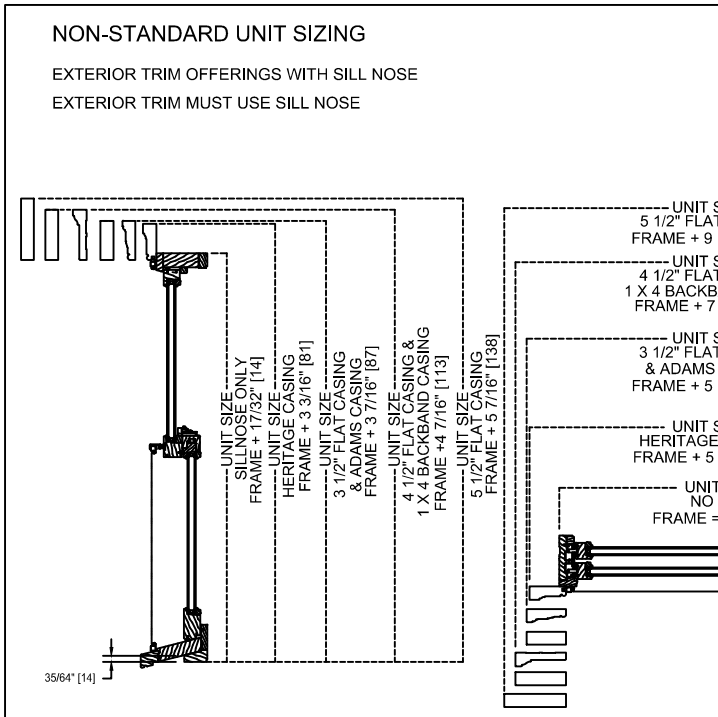
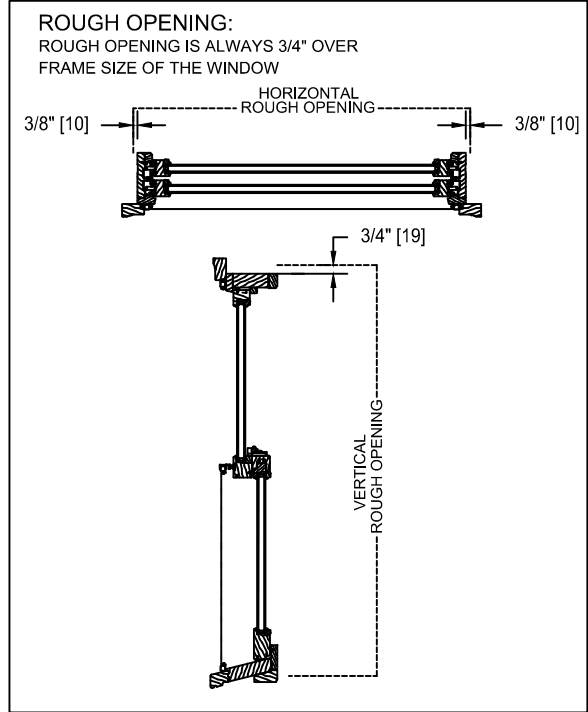

LITE CUT TABLES - SINGLE-HUNG SECTOR TOP
SINGLE-HUNG UNITS

SINGLE HUNG WINDOWS - CWDS

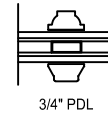

CWDS		Frame Height									
		36	40	48	52	56	64	68	76	80	
Frame Width	21	21 3/8	N/A	N/A	N/A	2W 2H	2W 2H	N/A	N/A	N/A	N/A
	25	25 3/8	N/A	3W 2H	N/A	3W 2H	3W 2H	3W 2H	3W 3H	3W 3H	N/A
	29	29 3/8	3W 2H	3W 2H	3W 2H	3W 2H	3W 2H	3W 2H	3W 3H	3W 3H	N/A
	33	33 3/8	3W 2H	3W 2H	3W 2H	3W 2H	3W 2H	3W 2H	3W 3H	3W 3H	3W 3H
	37	37 3/8	4W 2H	4W 2H	4W 2H	4W 2H	4W 2H	4W 2H	4W 3H	4W 3H	4W 3H
	41	41 3/8	N/A	4W 2H	4W 2H	4W 2H	4W 2H	4W 2H	4W 3H	N/A	N/A
	45	45 3/8	N/A	N/A	N/A	N/A	4W 2H	N/A	N/A	4W 3H	N/A

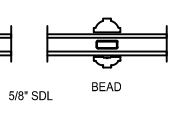
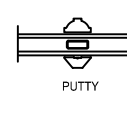
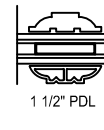
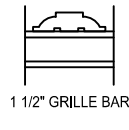
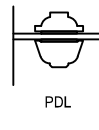

CWDS		Frame Height									
		36	40	48	52	56	64	68	76	80	
Frame Width	21	21 3/8	N/A	N/A	N/A	2W 2H	2W 2H	N/A	N/A	N/A	N/A
	25	25 3/8	N/A	2W 2H	N/A	2W 2H	2W 2H	2W 2H	2W 3H	2W 3H	N/A
	29	29 3/8	3W 1H	3W 2H	3W 2H	3W 2H	3W 2H	3W 2H	3W 3H	3W 3H	N/A
	33	33 3/8	3W 1H	3W 2H	3W 2H	3W 2H	3W 2H	3W 2H	3W 3H	3W 3H	3W 3H
	37	37 3/8	3W 1H	3W 2H	3W 2H	3W 2H	3W 2H	3W 2H	3W 3H	3W 3H	3W 3H
	41	41 3/8	N/A	4W 2H	4W 2H	4W 2H	4W 2H	4W 2H	4W 3H	N/A	N/A
	45	45 3/8	N/A	N/A	N/A	N/A	4W 2H	N/A	N/A	4W 3H	N/A

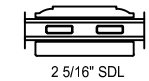
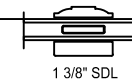
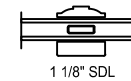
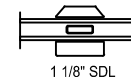
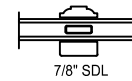
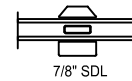
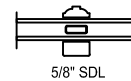
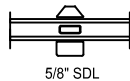

CONTEMPORARY SDL

SINGLE UNITS
ELEVATIONS

MO BRICKMOLD MO FLAT CASING ROUGH OPENING FRAME SIZE DAYLIGHT OPENING	24 5/8"(625) 27 11/16"(703) 22 1/8"(562) 21 3/8"(543) 15 7/16"(392)	28 5/8"(727) 31 11/16"(805) 26 1/8"(664) 25 3/8"(645) 19 7/16"(494)	32 5/8"(829) 35 11/16"(906) 30 1/8"(765) 29 3/8"(746) 23 7/16"(595)	34 5/8"(879) 37 11/16"(957) 32 1/8"(816) 31 3/8"(797) 25 7/16"(646)	36 5/8"(930) 39 11/16"(1008) 34 1/8"(867) 33 3/8"(848) 27 7/16"(697)	38 5/8"(981) 41 11/16"(1059) 36 1/8"(918) 35 3/8"(899) 29 7/16"(748)	40 5/8"(1032) 43 11/16"(1110) 38 1/8"(968) 37 3/8"(949) 31 7/16"(799)
34 13/32"(874) 35 15/16"(913) 32 3/4"(832) 32"(813) 11 1/8"(283)							
38 13/32"(976) 39 15/16"(1014) 36 3/4"(933) 36"(914) 13 1/8"(333)							
42 13/32"(1077) 43 15/16"(1116) 40 3/4"(1035) 40"(1016) 15 1/8"(384)							
46 13/32"(1179) 47 15/16"(1218) 44 3/4"(1137) 44"(1118) 17 1/8"(435)							
50 13/32"(1280) 51 15/16"(1319) 48 3/4"(1238) 48"(1219) 19 7/8"(486)							
54 13/32"(1382) 55 15/16"(1421) 52 3/4"(1340) 52"(1321) 21 1/8"(537)							

ELEVATION SYMBOL LEGEND:

- M.O. = MASORNY OPENING
- VALUES IN () ARE IN MILLIMETER CONVERSIONS
- E UNIT MEETS EGRESS REQUIREMENT FOR IRC CODE. STATE AND LOCAL EGRESS CODES MAY DIFFER. ALWAYS REFER TO LOCAL BUILDING CODES FOR COMPLETE REQUIREMENTS. CHECK WITH LOCAL OFFICIALS TO ENSURE COMPLIANCE BEFORE INSTALLING THE UNIT.
- E1: BASIC UNIT CLEAR OPENING EXCEEDS 20" IN WIDTH, 24" IN HEIGHT & A MINIMUM OF 5.0 SQ. FT., FOR FIRST FLOOR EGRESS.
- T BASIC UNIT IS NOT AVAILABLE WITH TRI-PANE GLASS.
- ## NUMBER INDICATES DESIGN PRESSURE (DP) RATING WITH STANDARD GLASS.
- ### NUMBER INDICATES HIGHER DP RATING, TALLER SILL STOP AND IMPACT GLAZING.

Note: Elevations shown DO NOT have exterior trim. Subtract 1/2"(12.7) from M.O.(Masonry Opening) for Unit Sizes. Masonry openings above include Sill Nose, see Trim Options page for Sill Nose specifications. For other Trim Options refer to the Unit Sizing, Rough Opening & Masonry Openings page.

SINGLE UNITS
ELEVATIONS

MO BRICKMOLD
MO FLAT CASING
ROUGH OPENING
FRAME SIZE
DAYLIGHT OPENING

24 5/8"(625)
27 11/16"(703)
22 1/8"(562)
21 3/8"(543)
15 7/16"(392)

28 5/8"(727)
31 11/16"(805)
26 1/8"(664)
25 3/8"(645)
19 7/16"(494)

32 5/8"(829)
35 11/16"(906)
30 1/8"(765)
29 3/8"(746)
23 7/16"(595)

34 5/8"(879)
37 11/16"(957)
32 1/8"(816)
31 3/8"(797)
25 7/16"(646)

36 5/8"(930)
39 11/16"(1008)
34 1/8"(867)
33 3/8"(848)
27 7/16"(697)

38 5/8"(981)
41 11/16"(1059)
36 1/8"(918)
35 3/8"(899)
29 7/16"(748)

40 5/8"(1032)
43 11/16"(1110)
38 1/8"(968)
37 3/8"(949)
31 7/16"(799)

58 13/32"(1484)
59 15/16"(1522)
56 3/4"(1441)
56"(1422)
23 1/8"(587)

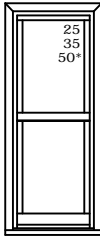

CWD2156

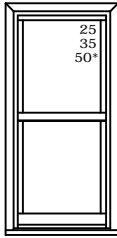

CWD2556

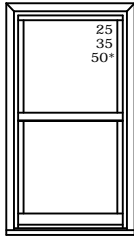

CWD2956

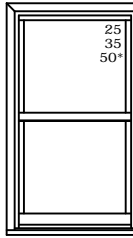

CWD3156

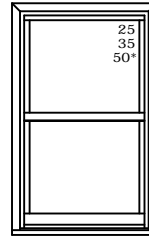

CWD3356

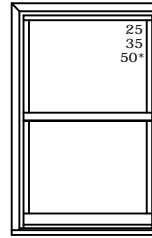

CWD3556

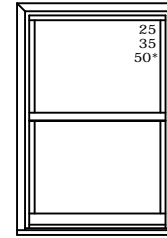

CWD3756

62 13/32"(1585)
63 15/16"(1624)
60 3/4"(1543)
60"(1524)
25 1/8"(638)

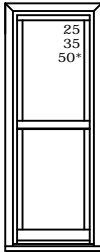

CWD2160

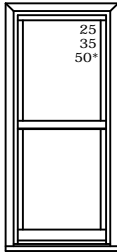

CWD2560

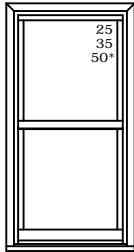

CWD2960

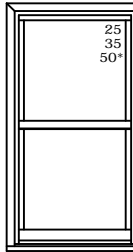

CWD3160

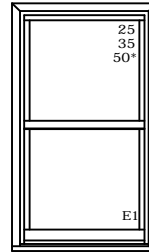

CWD3360

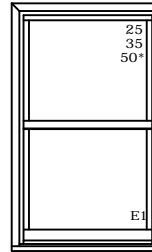

CWD3560

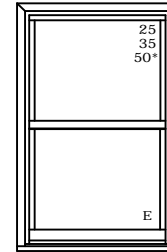

CWD3760

66 13/32"(1687)
67 15/16"(1726)
64 3/4"(1645)
64"(1626)
27 1/8"(689)

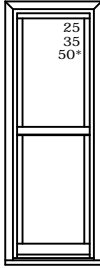

CWD2164

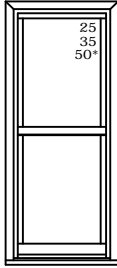

CWD2564

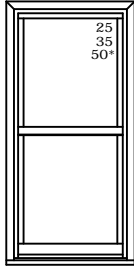

CWD2964

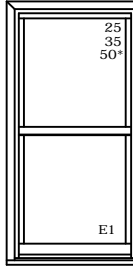

CWD3164

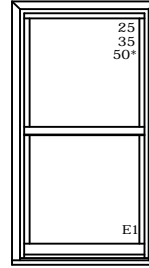

CWD3364



CWD3564

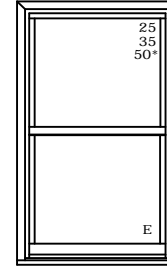

CWD3764

70 13/32"(1788)
71 15/16"(1827)
68 3/4"(1746)
68"(1727)
29 1/8"(740)

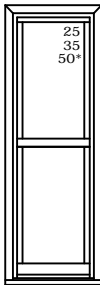

CWD2168

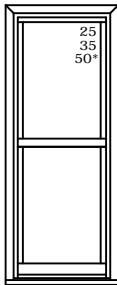

CWD2568

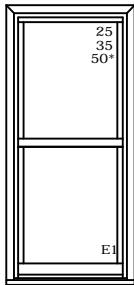

CWD2968

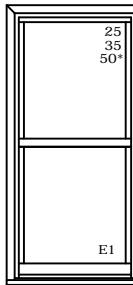

CWD3168

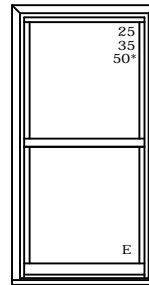

CWD3368

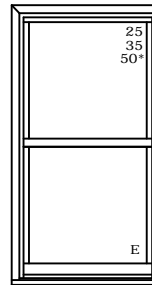

CWD3568

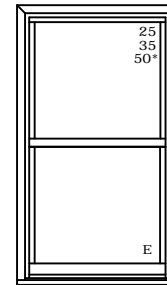

CWD3768

ELEVATION SYMBOL LEGEND:

- M.O. = MASORNY OPENING
- VALUES IN () ARE IN MILLIMETER CONVERSIONS
- E UNIT MEETS EGRESS REQUIREMENT FOR IRC CODE. STATE AND LOCAL EGRESS CODES MAY DIFFER. ALWAYS REFER TO LOCAL BUILDING CODES FOR COMPLETE REQUIREMENTS. CHECK WITH LOCAL OFFICIALS TO ENSURE COMPLIANCE BEFORE INSTALLING THE UNIT.
- E1 BASIC UNIT CLEAR OPENING EXCEEDS 20" IN WIDTH, 24" IN HEIGHT & A MINIMUM OF 5.0 SQ. FT., FOR FIRST FLOOR EGRESS.
- T BASIC UNIT IS NOT AVAILABLE WITH TRI-PANE GLASS.
- ## NUMBER INDICATES DESIGN PRESSURE (DP) RATING WITH STANDARD GLASS.
- ##* NUMBER INDICATES HIGHER DP RATING, TALLER SILL STOP AND IMPACT GLAZING.

Note: Elevations shown DO NOT have exterior trim. Subtract 1/2"(12.7) from M.O.(Masonry Opening) for Unit Sizes. Masonry openings above include Sill Nose, see Trim Options page for Sill Nose specifications. For other Trim Options refer to the Unit Sizing, Rough Opening & Masonry Openings page.

SINGLE UNITS
ELEVATIONS

MO BRICKMOLD	24 5/8"(625)	28 5/8"(727)	32 5/8"(829)	34 5/8"(879)	36 5/8"(930)	38 5/8"(981)	40 5/8"(1032)
MO FLAT CASING	27 11/16"(703)	31 11/16"(805)	35 11/16"(906)	37 11/16"(957)	39 11/16"(1008)	41 11/16"(1059)	43 11/16"(1110)
ROUGH OPENING	22 1/8"(562)	26 1/8"(664)	30 1/8"(765)	32 1/8"(816)	34 1/8"(867)	36 1/8"(918)	38 1/8"(968)
FRAME SIZE	21 3/8"(543)	25 3/8"(645)	29 3/8"(746)	31 3/8"(797)	33 3/8"(848)	35 3/8"(899)	37 3/8"(949)
DAYLIGHT OPENING	15 7/16"(392)	19 7/16"(494)	23 7/16"(595)	25 7/16"(646)	27 7/16"(697)	29 7/16"(748)	31 7/16"(799)

74 13/32"(1890)
75 15/16"(1929)
72 3/4"(1848)
72"(18229)
31 1/8"(791)

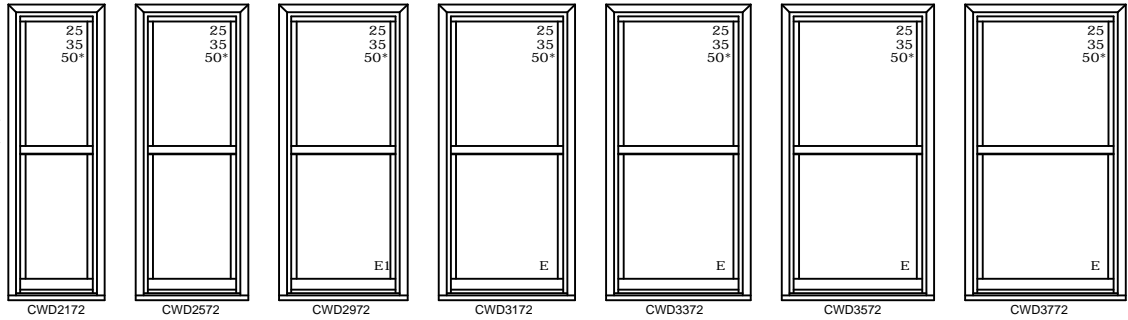

78 13/32"(1994)
79 15/16"(2030)
76 3/4"(1949)
76"(1930)
33 1/8"(841)

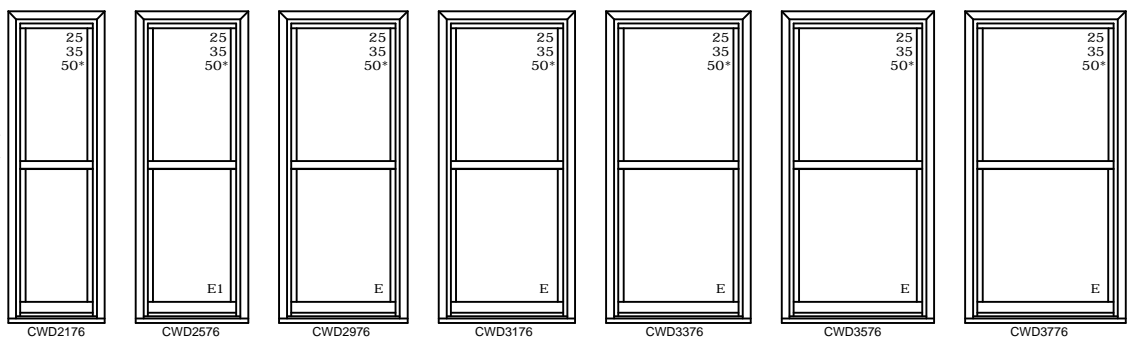

82 13/32"(2093)
83 15/16"(2132)
80 3/4"(2051)
80"(2032)
35 1/8"(892)

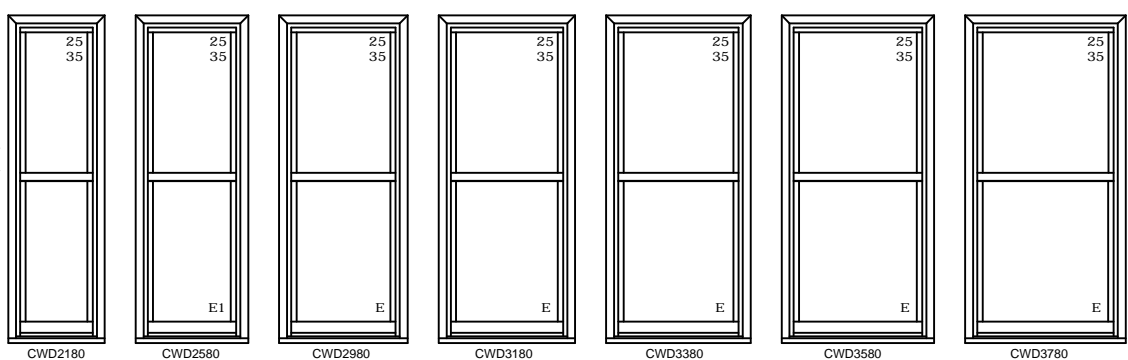

90 13/32"(2296)
91 15/16"(2335)
88 3/4"(2254)
88"(2235)
39 1/8"(994)

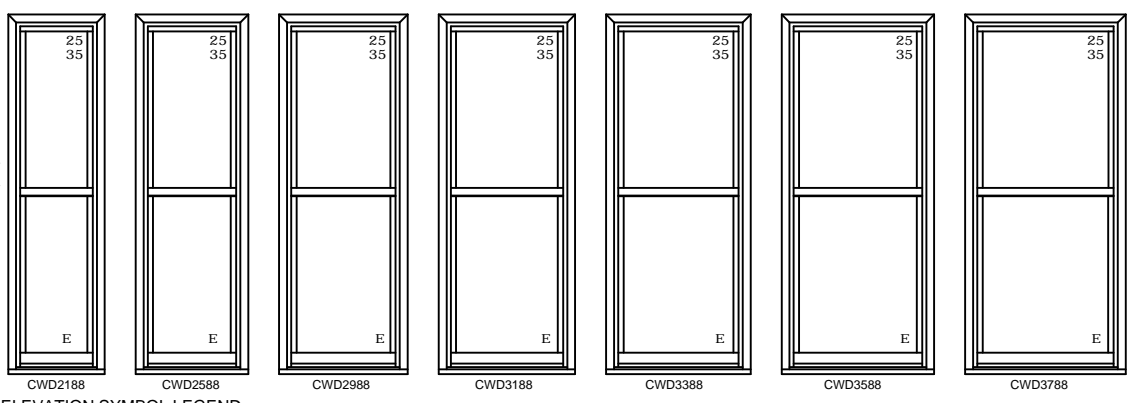

ELEVATION SYMBOL LEGEND:

M.O. = MASORNY OPENING
VALUES IN () ARE IN MILLIMETER CONVERSIONS
E UNIT MEETS EGRESS REQUIREMENT FOR IRC CODE. STATE AND LOCAL EGRESS CODES MAY DIFFER. ALWAYS REFER TO LOCAL BUILDING CODES FOR COMPLETE REQUIREMENTS. CHECK WITH LOCAL OFFICIALS TO ENSURE COMPLIANCE BEFORE INSTALLING THE UNIT.
E1 BASIC UNIT CLEAR OPENING EXCEEDS 20" IN WIDTH, 24" IN HEIGHT & A MINIMUM OF 5.0 SQ. FT., FOR FIRST FLOOR EGRESS.
T BASIC UNIT IS NOT AVAILABLE WITH TRI-PANE GLASS.
NUMBER INDICATES DESIGN PRESSURE (DP) RATING WITH STANDARD GLASS.
NUMBER INDICATES HIGHER DP RATING, TALLER SILL STOP AND IMPACT GLAZING.
Note: Elevations shown DO NOT have exterior trim. Subtract 1/2"(12.7) from M.O.(Masonry Opening) for Unit Sizes. Masonry openings above include Sill Nose, see Trim Options page for Sill Nose specifications. For other Trim Options refer to the Unit Sizing, Rough Opening & Masonry Openings page.

SINGLE UNITS
ELEVATIONS

MO BRICKMOLD
MO FLAT CASING
ROUGH OPENING
FRAME SIZE
DAYLIGHT OPENING

24 5/8"(625)
27 11/16"(703)
22 1/8"(562)
21 3/8"(543)
15 7/16"(392)

28 5/8"(727)
31 11/16"(805)
26 1/8"(664)
25 3/8"(645)
19 7/16"(494)

32 5/8"(829)
35 11/16"(906)
30 1/8"(765)
29 3/8"(746)
23 7/16"(595)

34 5/8"(879)
37 11/16"(957)
32 1/8"(816)
31 3/8"(797)
25 7/16"(646)

36 5/8"(930)
39 11/16"(1008)
34 1/8"(867)
33 3/8"(848)
27 7/16"(697)

38 5/8"(981)
41 11/16"(1059)
36 1/8"(918)
35 3/8"(899)
29 7/16"(748)

40 5/8"(1032)
43 11/16"(1110)
38 1/8"(968)
37 3/8"(949)
31 7/16"(799)

94 13/32"(2398)
95 15/16"(2437)
92 3/4"(2386)
92"(2337)
41 1/8"(1046)

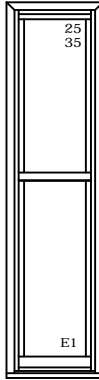

CWD2192

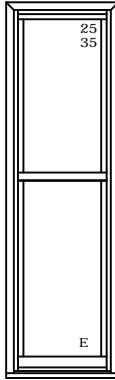

CWD2592

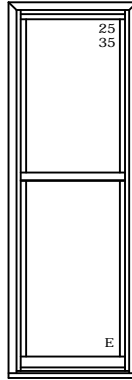

CWD2992

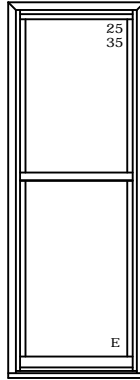

CWD3192

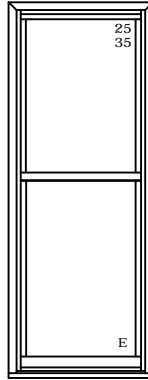

CWD3392

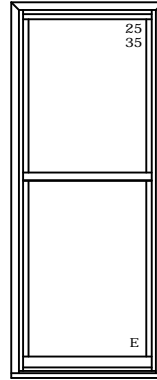

CWD3592

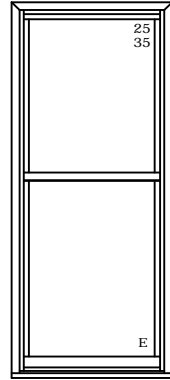

CWD3792

98 13/32"(2500)
99 15/16"(2538)
96 3/4"(2487)
96"(2438)
43 1/8"(1095)

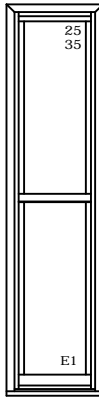

CWD2196

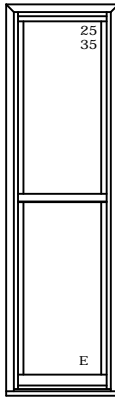

CWD2596

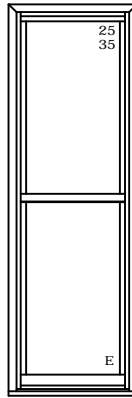

CWD2996

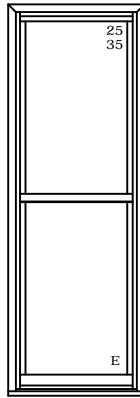

CWD3196

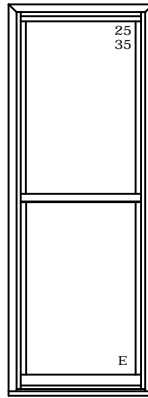

CWD3396

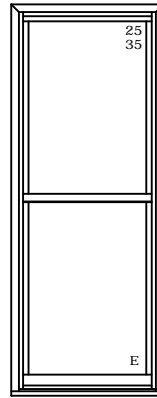

CWD3596

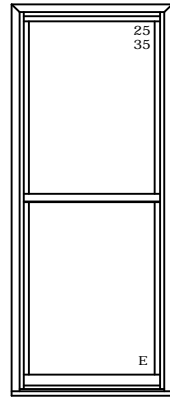

CWD3796

101 13/32"(2576)
101 15/16"(2589)
98 3/4"(2508)
98"(2489)
44 1/8"(1121)

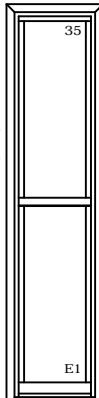

CWD2198

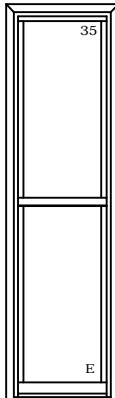

CWD2598

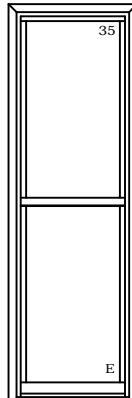

CWD2998

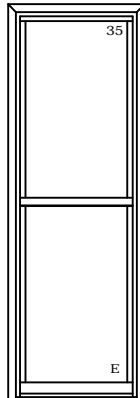

CWD3198

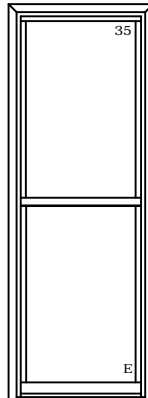

CWD3398

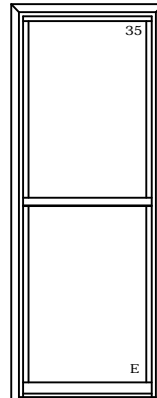

CWD3598

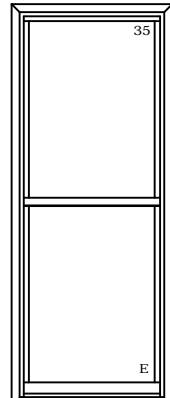

CWD3798

ELEVATION SYMBOL LEGEND:

- M.O. = MASORNY OPENING
- VALUES IN () ARE IN MILLIMETER CONVERSIONS
- E UNIT MEETS EGRESS REQUIREMENT FOR IRC CODE. STATE AND LOCAL EGRESS CODES MAY DIFFER. ALWAYS REFER TO LOCAL BUILDING CODES FOR COMPLETE REQUIREMENTS. CHECK WITH LOCAL OFFICIALS TO ENSURE COMPLIANCE BEFORE INSTALLING THE UNIT.
- E1 BASIC UNIT CLEAR OPENING EXCEEDS 20" IN WIDTH, 24" IN HEIGHT & A MINIMUM OF 5.0 SQ. FT., FOR FIRST FLOOR EGRESS.
- T BASIC UNIT IS NOT AVAILABLE WITH TRI-PANE GLASS.
- ## NUMBER INDICATES DESIGN PRESSURE (DP) RATING WITH STANDARD GLASS.
- ### NUMBER INDICATES HIGHER DP RATING, TALLER SILL STOP AND IMPACT GLAZING.

Note: Elevations shown DO NOT have exterior trim. Subtract 1/2"(12.7) from M.O.(Masonry Opening) for Unit Sizes. Masonry openings above include Sill Nose, see Trim Options page for Sill Nose specifications. For other Trim Options refer to the Unit Sizing, Rough Opening & Masonry Openings page.

SINGLE UNITS
ELEVATIONS

MO BRICKMOLD
MO FLAT CASING
ROUGH OPENING
FRAME SIZE
DAYLIGHT OPENING

44 5/8"(1133)
47 11/16"(1211)
42 1/8"(1070)
41 3/8"(1051)
35 7/16"(900)

48 5/8"(1235)
51 11/16"(1313)
46 1/8"(1172)
45 3/8"(1153)
39 7/16"(1002)

52 5/8"(1337)
55 11/16"(1414)
50 1/8"(1273)
49 3/8"(1254)
43 7/16"(1103)

34 13/32"(874) 33 1/16"(813) 32 27/8"(832) 11 1/8"(283)			
CWD4132	CWD4532	CWD4932	
38 13/32"(976) 39 15/16"(1014) 38 3/8"(953) 13 1/8"(333)			
CWD4136	CWD4536	CWD4936	
42 13/32"(1077) 43 15/16"(1116) 40 3/4"(1035) 15 1/8"(384)			
CWD4140	CWD4540	CWD4940	
46 13/32"(1179) 47 15/16"(1216) 44 3/4"(1137) 17 1/8"(435)			
CWD4144	CWD4544	CWD4944	
50 13/32"(1280) 51 15/16"(1319) 48 3/4"(1238) 19 1/8"(486)			
CWD4148	CWD4548	CWD4948	
54 13/32"(1382) 55 15/16"(1421) 52 27/8"(1340) 21 1/8"(537)			
CWD4152	CWD4552	CWD4952	

ELEVATION SYMBOL LEGEND:

- M.O. = MASORNY OPENING
- VALUES IN () ARE IN MILLIMETER CONVERSIONS
- E UNIT MEETS EGRESS REQUIREMENT FOR IRC CODE. STATE AND LOCAL EGRESS CODES MAY DIFFER. ALWAYS REFER TO LOCAL BUILDING CODES FOR COMPLETE REQUIREMENTS. CHECK WITH LOCAL OFFICIALS TO ENSURE COMPLIANCE BEFORE INSTALLING THE UNIT.
- E1 BASIC UNIT CLEAR OPENING EXCEEDS 20" IN WIDTH, 24" IN HEIGHT & A MINIMUM OF 5.0 SQ. FT., FOR FIRST FLOOR EGRESS.
- T BASIC UNIT IS NOT AVAILABLE WITH TRI-PANE GLASS.
- ## NUMBER INDICATES DESIGN PRESSURE (DP) RATING WITH STANDARD GLASS.
- ##* NUMBER INDICATES HIGHER DP RATING, TALLER SILL STOP AND IMPACT GLAZING.

Note: Elevations shown DO NOT have exterior trim. Subtract 1/2"(12.7) from M.O.(Masonry Opening) for Unit Sizes. Masonry openings above include Sill Nose, see Trim Options page for Sill Nose specifications. For other Trim Options refer to the Unit Sizing, Rough Opening & Masonry Openings page.

SINGLE UNITS
ELEVATIONS

MO BRICKMOLD
MO FLAT CASING
ROUGH OPENING
FRAME SIZE
DAYLIGHT OPENING

44 5/8"(1133)
47 11/16"(1211)
42 1/8"(1070)
41 3/8"(1051)
35 7/16"(900)

48 5/8"(1235)
51 11/16"(1313)
46 1/8"(1172)
45 3/8"(1153)
39 7/16"(1002)

52 5/8"(1337)
55 11/16"(1414)
50 1/8"(1273)
49 3/8"(1254)
43 7/16"(1103)

58 13/32"(1484)
59 15/16"(1522)
56 3/4"(1441)
56"(1422)
23 1/8"(587)

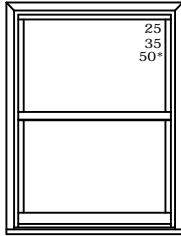

CWD4156

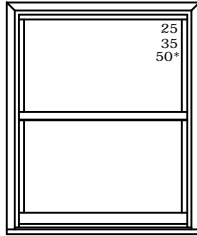

CWD4556

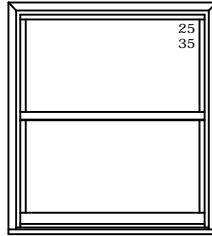

CWD4956

62 13/32"(1585)
63 15/16"(1624)
60 3/4"(1543)
60"(1524)
25 1/8"(638)

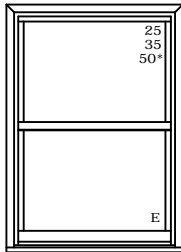

CWD4160

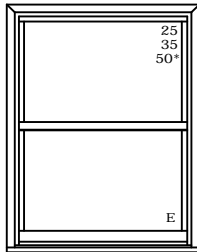

CWD4560

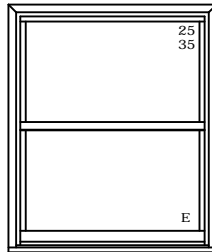

CWD4960

66 13/32"(1687)
67 15/16"(1726)
64 3/4"(1645)
64"(1626)
27 1/8"(689)

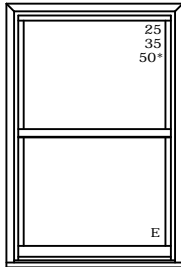

CWD4164

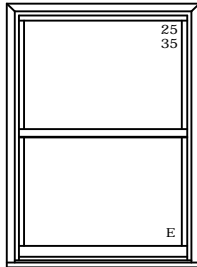

CWD4564

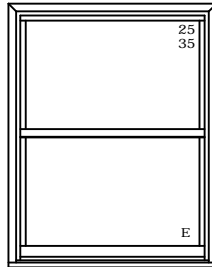

CWD4964

70 13/32"(1788)
71 15/16"(1827)
68 3/4"(1746)
68"(1727)
29 1/8"(740)

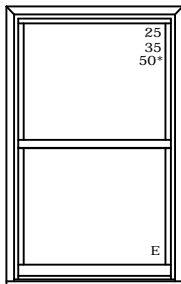

CWD4168

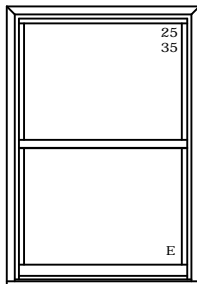

CWD4568

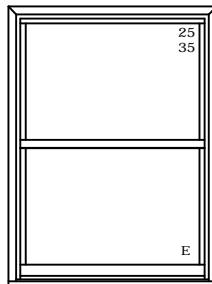

CWD4968

ELEVATION SYMBOL LEGEND:

- M.O. = MASORNY OPENING
- VALUES IN () ARE IN MILLIMETER CONVERSIONS
- E UNIT MEETS EGRESS REQUIREMENT FOR IRC CODE. STATE AND LOCAL EGRESS CODES MAY DIFFER. ALWAYS REFER TO LOCAL BUILDING CODES FOR COMPLETE REQUIREMENTS. CHECK WITH LOCAL OFFICIALS TO ENSURE COMPLIANCE BEFORE INSTALLING THE UNIT.
- E1 BASIC UNIT CLEAR OPENING EXCEEDS 20" IN WIDTH, 24" IN HEIGHT & A MINIMUM OF 5.0 SQ. FT., FOR FIRST FLOOR EGRESS.
- T BASIC UNIT IS NOT AVAILABLE WITH TRI-PANE GLASS.
- ## NUMBER INDICATES DESIGN PRESSURE (DP) RATING WITH STANDARD GLASS.
- ### NUMBER INDICATES HIGHER DP RATING, TALLER SILL STOP AND IMPACT GLAZING.

Note: Elevations shown DO NOT have exterior trim. Subtract 1/2"(12.7) from M.O.(Masonry Opening) for Unit Sizes. Masonry openings above include Sill Nose, see Trim Options page for Sill Nose specifications. For other Trim Options refer to the Unit Sizing, Rough Opening & Masonry Openings page.

SINGLE UNITS
ELEVATIONS

MO BRICKMOLD
MO FLAT CASING
ROUGH OPENING
FRAME SIZE
DAYLIGHT OPENING

44 5/8"(1133)
47 11/16"(1211)
42 1/8"(1070)
41 3/8"(1051)
35 7/16"(900)

48 5/8"(1235)
51 11/16"(1313)
46 1/8"(1172)
45 3/8"(1153)
39 7/16"(1002)

52 5/8"(1337)
55 11/16"(1414)
50 1/8"(1273)
49 3/8"(1254)
43 7/16"(1103)

74 13/32"(1890)
75 15/16"(1929)
72 3/4"(1846)
72 (1829)
31 1/8"(791)

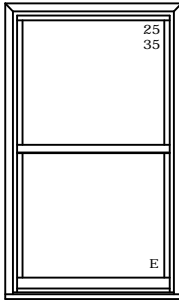

CWD4172

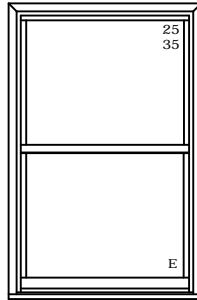

CWD4572

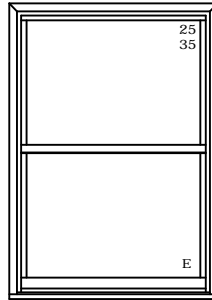

CWD4972

78 13/32"(1984)
79 15/16"(2030)
76 3/4"(1949)
76 (1930)
33 1/8"(841)

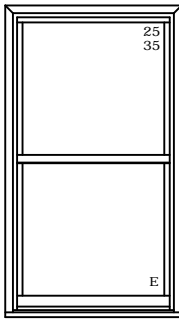

CWD4176

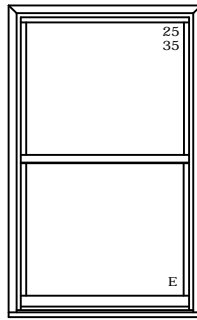

CWD4576

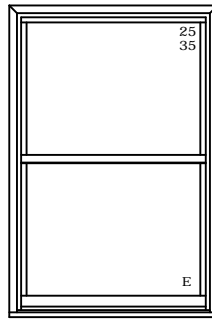

CWD4976

82 13/32"(2093)
83 15/16"(2132)
80 3/4"(2051)
80 (2032)
35 1/8"(892)

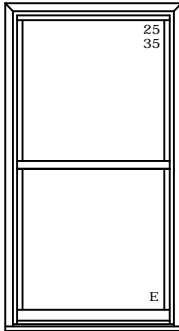

CWD4180

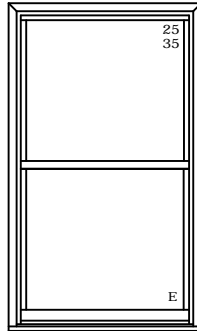

CWD4580

90 13/32"(2296)
91 15/16"(2335)
88 3/4"(2254)
88 (2235)
39 1/8"(994)

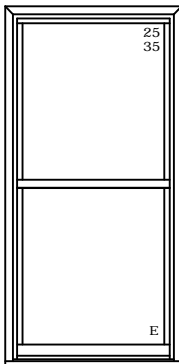

CWD4188

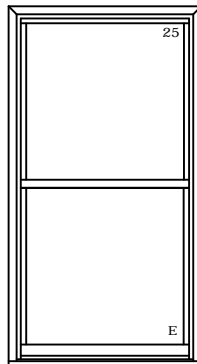

CWD4588

ELEVATION SYMBOL LEGEND:

- M.O. = MASORNY OPENING
- VALUES IN () ARE IN MILLIMETER CONVERSIONS
- E UNIT MEETS EGRESS REQUIREMENT FOR IRC CODE. STATE AND LOCAL EGRESS CODES MAY DIFFER. ALWAYS REFER TO LOCAL BUILDING CODES FOR COMPLETE REQUIREMENTS. CHECK WITH LOCAL OFFICIALS TO ENSURE COMPLIANCE BEFORE INSTALLING THE UNIT.
- E1 BASIC UNIT CLEAR OPENING EXCEEDS 20" IN WIDTH, 24" IN HEIGHT & A MINIMUM OF 5.0 SQ. FT., FOR FIRST FLOOR EGRESS.
- T BASIC UNIT IS NOT AVAILABLE WITH TRI-PANE GLASS.
- ## NUMBER INDICATES DESIGN PRESSURE (DP) RATING WITH STANDARD GLASS.
- ### NUMBER INDICATES HIGHER DP RATING, TALLER SILL STOP AND IMPACT GLAZING.

Note: Elevations shown DO NOT have exterior trim. Subtract 1/2"(12.7) from M.O.(Masonry Opening) for Unit Sizes. Masonry openings above include Sill Nose, see Trim Options page for Sill Nose specifications. For other Trim Options refer to the Unit Sizing, Rough Opening & Masonry Openings page.

SINGLE UNITS
ELEVATIONS

MO BRICKMOLD	44 5/8"(1133)	48 5/8"(1235)
MO FLAT CASING	47 11/16"(1211)	51 11/16"(1313)
ROUGH OPENING	42 1/8"(1070)	46 1/8"(1172)
FRAME SIZE	41 3/8"(1051)	45 3/8"(1153)
DAYLIGHT OPENING	35 7/16"(900)	39 7/16"(1002)

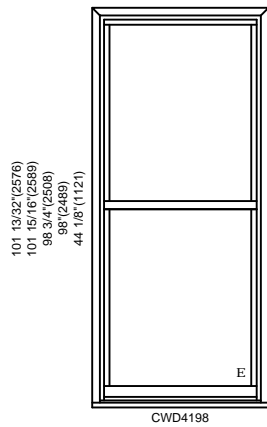
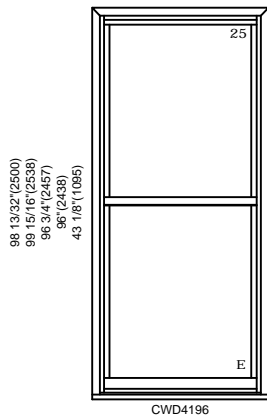
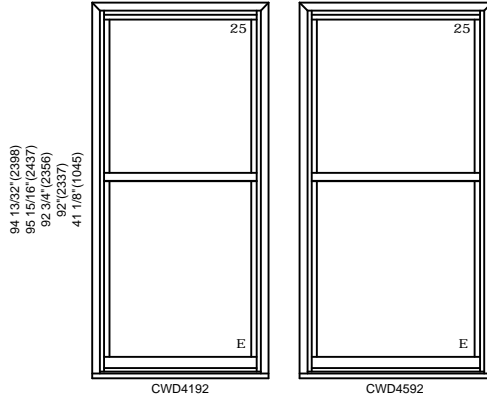

ELEVATION SYMBOL LEGEND:

- M.O. = MASORNY OPENING
- VALUES IN () ARE IN MILLIMETER CONVERSIONS
- E UNIT MEETS EGRESS REQUIREMENT FOR IRC CODE. STATE AND LOCAL EGRESS CODES MAY DIFFER. ALWAYS REFER TO LOCAL BUILDING CODES FOR COMPLETE REQUIREMENTS. CHECK WITH LOCAL OFFICIALS TO ENSURE COMPLIANCE BEFORE INSTALLING THE UNIT.
- E1 BASIC UNIT CLEAR OPENING EXCEEDS 20" IN WIDTH, 24" IN HEIGHT & A MINIMUM OF 5.0 SQ. FT., FOR FIRST FLOOR EGRESS.
- T BASIC UNIT IS NOT AVAILABLE WITH TRI-PANE GLASS.
- ## NUMBER INDICATES DESIGN PRESSURE (DP) RATING WITH STANDARD GLASS.
- ##* NUMBER INDICATES HIGHER DP RATING, TALLER SILL STOP AND IMPACT GLAZING.

Note: Elevations shown DO NOT have exterior trim. Subtract 1/2"(12.7) from M.O.(Masonry Opening) for Unit Sizes. Masonry openings above include Sill Nose, see Trim Options page for Sill Nose specifications. For other Trim Options refer to the Unit Sizing, Rough Opening & Masonry Openings page.

PICTURE UNITS
ELEVATIONS

MO BRICKMOLD
MO FLAT CASING
ROUGH OPENING
FRAME SIZE
DAYLIGHT OPENING

44 58*(1133)
47 11/16*(1211)
42 1/8*(1070)
41 3/8*(1051)
35 7/16*(900)

48 58*(1235)
51 11/16*(1313)
46 1/8*(1172)
45 3/8*(1153)
39 7/16*(1002)

52 58*(1337)
55 11/16*(1414)
50 1/8*(1273)
49 3/8*(1254)
43 7/16*(1103)

56 58*(1438)
59 11/16*(1516)
54 1/8*(1375)
53 3/8*(1356)
47 7/16*(1205)

64 58*(1641)
67 11/16*(1719)
62 1/8*(1578)
61 3/8*(1559)
55 7/16*(1408)

42 13/32*(1077)
43 5/16*(1116)
40 3/4*(1035)
40 1/2*(1018)
32 3/8*(822)

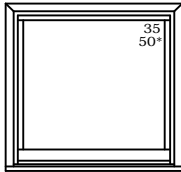

CWDP4140

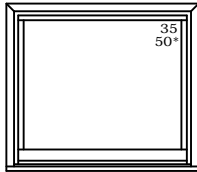

CWDP4540

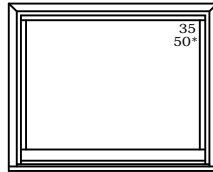

CWDP4940

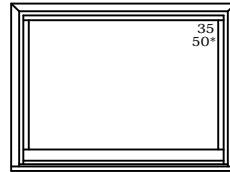

CWDP5340



CWDP6140

46 13/32*(1179)
47 1/16*(1218)
44 3/4*(1137)
44 1/2*(1118)
36 3/8*(924)

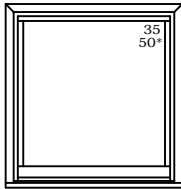

CWDP4144

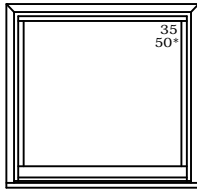

CWDP4544

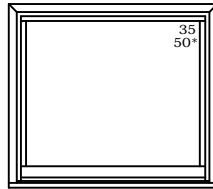

CWDP4944

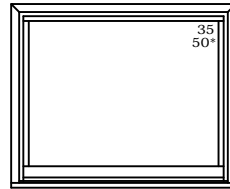

CWDP5344

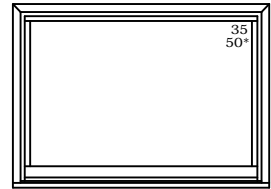

CWDP6144

50 13/32*(1280)
51 13/16*(1319)
48 3/4*(1238)
48 1/2*(1219)
40 3/8*(1026)

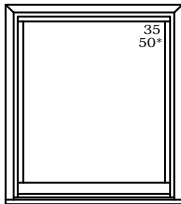

CWDP4148

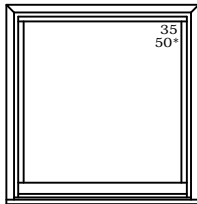

CWDP4548

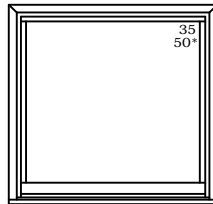

CWDP4948

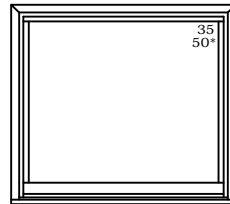

CWDP5348

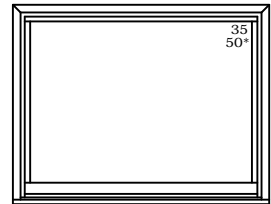

CWDP6148

54 13/32*(1382)
55 15/16*(1421)
52 3/4*(1340)
52 1/2*(1321)
44 3/8*(1127)

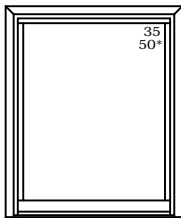

CWDP4152

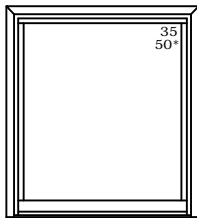

CWDP4552

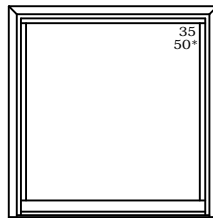

CWDP4952

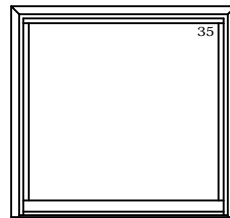

CWDP5352

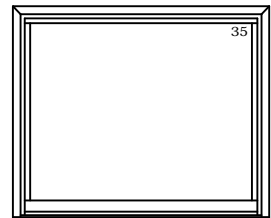

CWDP6152

58 13/32*(1484)
59 15/16*(1522)
56 3/4*(1441)
56 1/2*(1422)
48 3/8*(1228)

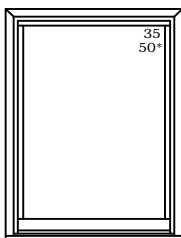

CWDP4156

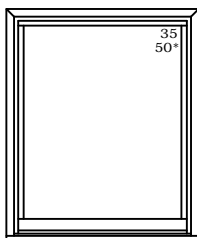

CWDP4556

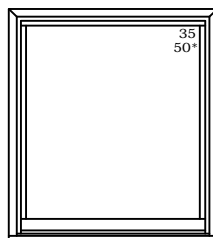

CWDP4956

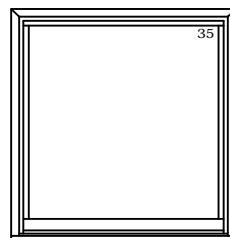

CWDP5356

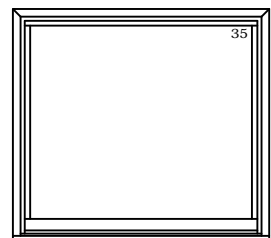

CWDP6156

62 13/32*(1586)
63 15/16*(1624)
60 3/4*(1543)
60 1/2*(1524)
52 3/8*(1330)

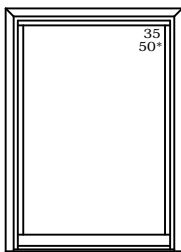

CWDP4160

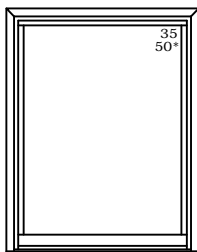

CWDP4560

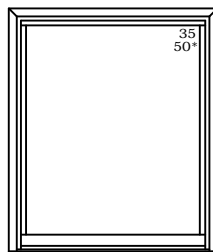

CWDP4960

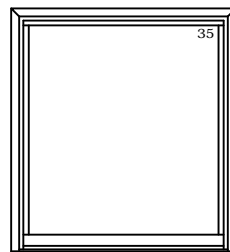

CWDP5360

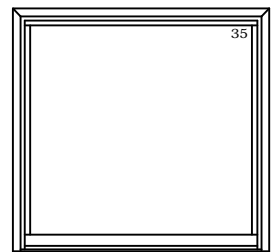

CWDP6160

ELEVATION SYMBOL LEGEND:

- M.O. = MASORNY OPENING
- VALUES IN () ARE IN MILLIMETER CONVERSIONS
- T BASIC UNIT IS NOT AVAILABLE WITH TRI-PANE GLASS.
- ## NUMBER INDICATES DESIGN PRESSURE (DP) RATING WITH STANDARD GLASS.
- ### NUMBER INDICATES HIGHER DP RATING, TALLER SILL STOP AND IMPACT GLAZING.

Note: Elevations shown DO NOT have exterior trim. Subtract 1/2"(12.7) from M.O.(Masonry Opening) for Unit Sizes. Masonry openings above include Sill Nose, see Trim Options page for Sill Nose specifications. For other Trim Options refer to the Unit Sizing, Rough Opening & Masonry Openings page.

PICTURE UNITS
ELEVATIONS

MO BRICKMOLD
MO FLAT CASING
ROUGH OPENING
FRAME SIZE
DAYLIGHT OPENING

44 58"(1133)
47 11/16"(1211)
42 1/8"(1070)
41 3/8"(1051)
35 7/16"(900)

48 58"(1235)
51 11/16"(1313)
46 1/8"(1172)
45 3/8"(1153)
39 7/16"(1002)

52 58"(1337)
55 11/16"(1414)
50 1/8"(1273)
49 3/8"(1254)
43 7/16"(1103)

56 58"(1438)
59 11/16"(1516)
54 1/8"(1375)
53 3/8"(1356)
47 7/16"(1205)

64 58"(1641)
67 11/16"(1719)
62 1/8"(1578)
61 3/8"(1559)
55 7/16"(1408)

66 13/32"(1687)
67 15/16"(1726)
64 3/4"(1645)
63 1/2"(1623)
56 3/8"(1432)

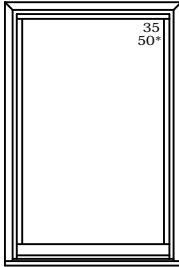

CWDP4164

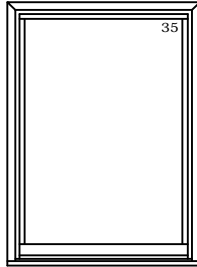

CWDP4564

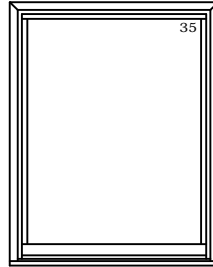

CWDP4964

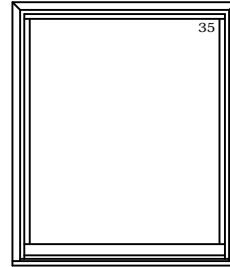

CWDP5364

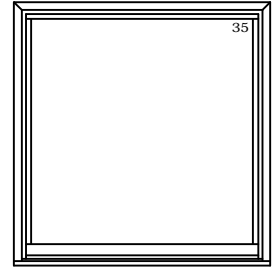

CWDP6164

70 13/32"(1788)
71 15/16"(1827)
68 3/4"(1746)
68 1/2"(1724)
60 3/8"(1534)

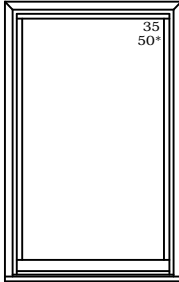

CWDP4168

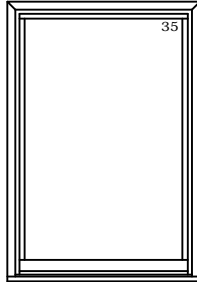

CWDP4568

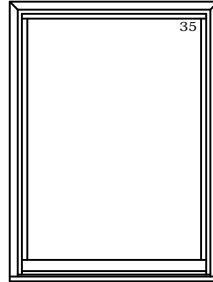

CWDP4968

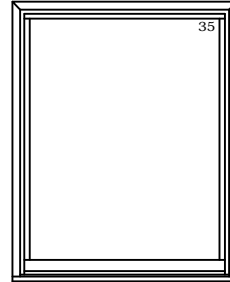

CWDP5368

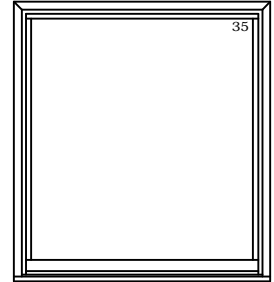

CWDP6168

74 13/32"(1890)
75 15/16"(1929)
72 3/4"(1848)
72 1/2"(1826)
64 3/8"(1635)

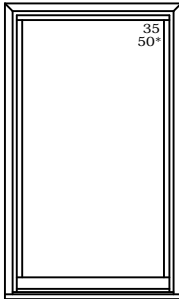

CWDP4172

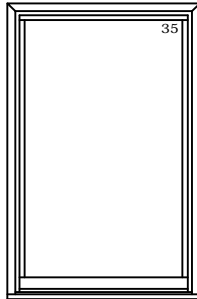

CWDP4572

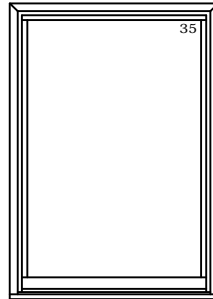

CWDP4972

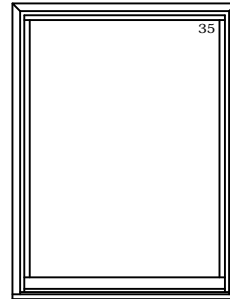

CWDP5372

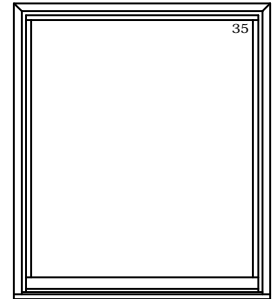

CWDP6172

ELEVATION SYMBOL LEGEND:

- M.O. = MASORNY OPENING
- VALUES IN () ARE IN MILLIMETER CONVERSIONS
- T BASIC UNIT IS NOT AVAILABLE WITH TRI-PANE GLASS.
- ## NUMBER INDICATES DESIGN PRESSURE (DP) RATING WITH STANDARD GLASS.
- ### NUMBER INDICATES HIGHER DP RATING, TALLER SILL STOP AND IMPACT GLAZING.

Note: Elevations shown DO NOT have exterior trim. Subtract 1/2"(12.7) from M.O.(Masonry Opening) for Unit Sizes. Masonry openings above include Sill Nose, see Trim Options page for Sill Nose specifications. For other Trim Options refer to the Unit Sizing, Rough Opening & Masonry Openings page.

PICTURE UNITS
ELEVATIONS

MO BRICKMOLD
MO FLAT CASING
ROUGH OPENING
FRAME SIZE
DAYLIGHT OPENING

44 58"(1133)
47 11/16"(1211)
42 1/8"(1070)
41 3/8"(1051)
35 7/16"(900)

48 58"(1235)
51 11/16"(1313)
46 1/8"(1172)
45 3/8"(1153)
39 7/16"(1002)

52 58"(1337)
55 11/16"(1414)
50 1/8"(1273)
49 3/8"(1254)
43 7/16"(1103)

56 58"(1438)
59 11/16"(1516)
54 1/8"(1375)
53 3/8"(1356)
47 7/16"(1205)

64 58"(1641)
67 11/16"(1719)
62 1/8"(1578)
61 3/8"(1559)
55 7/16"(1408)

78 13/32"(1984)
79 15/16"(2030)
76 3/4"(1949)
76"(1930)
66 3/8"(1737)

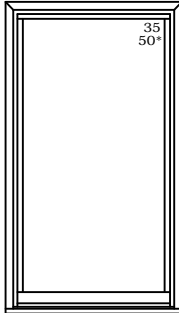

CWDP4176

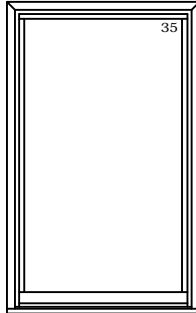

CWDP4576

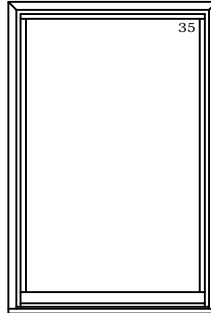

CWDP4976

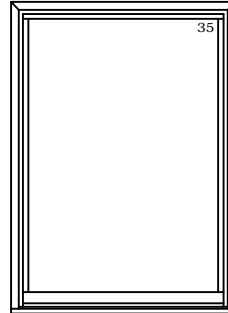

CWDP5376

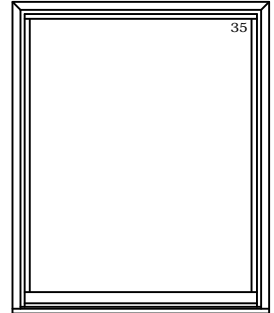

CWDP6176

82 13/32"(2053)
83 15/16"(2132)
80 3/4"(2051)
80"(2032)
72 11/16"(1838)

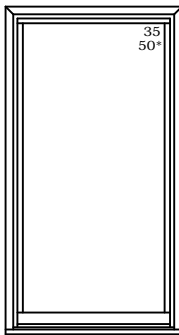

CWDP4180

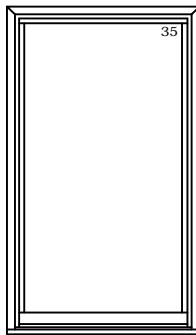

CWDP4580

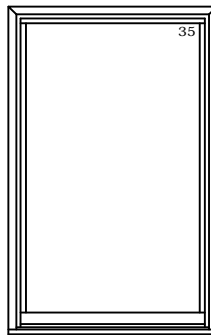

CWDP4980

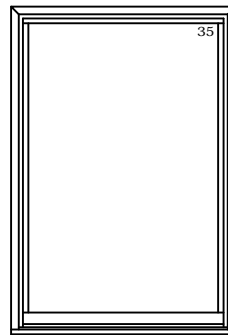

CWDP5380

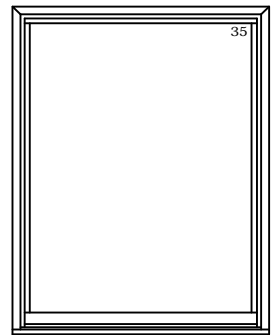

CWDP6180

80 13/32"(2286)
81 15/16"(2335)
86 3/4"(2254)
86"(2235)
80 3/8"(2242)

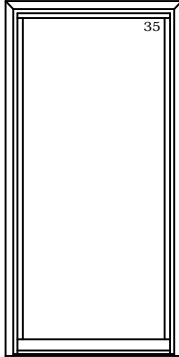

CWDP4188

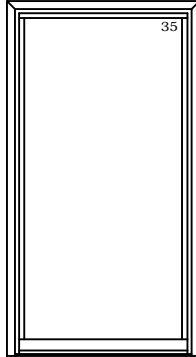

CWDP4588

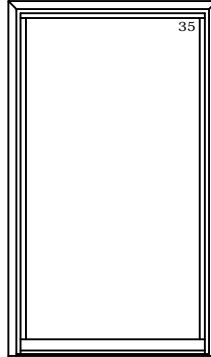

CWDP4988

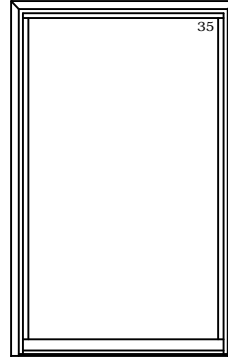

CWDP5388

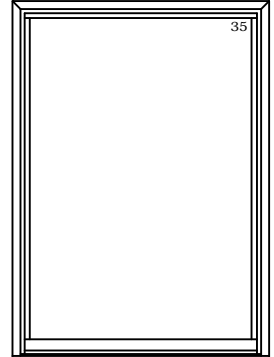

CWDP6188

ELEVATION SYMBOL LEGEND:

- M.O. = MASONRY OPENING
- VALUES IN () ARE IN MILLIMETER CONVERSIONS
- T BASIC UNIT IS NOT AVAILABLE WITH TRI-PANE GLASS.
- ## NUMBER INDICATES DESIGN PRESSURE (DP) RATING WITH STANDARD GLASS.
- ##* NUMBER INDICATES HIGHER DP RATING, TALLER SILL STOP AND IMPACT GLAZING.

Note: Elevations shown DO NOT have exterior trim. Subtract 1/2"(12.7) from M.O.(Masonry Opening) for Unit Sizes. Masonry openings above include Sill Nose, see Trim Options page for Sill Nose specifications. For other Trim Options refer to the Unit Sizing, Rough Opening & Masonry Openings page.

PICTURE UNITS
ELEVATIONS

MO BRICKMOLD
MO FLAT CASING
ROUGH OPENING
FRAME SIZE
DAYLIGHT OPENING

44 58*(1133)
47 11/16*(1211)
42 1/8*(1070)
41 3/8*(1051)
35 7/16*(900)

48 58*(1235)
51 11/16*(1313)
46 1/8*(1172)
45 3/8*(1153)
39 7/16*(1002)

52 58*(1337)
55 11/16*(1414)
50 1/8*(1273)
49 3/8*(1254)
43 7/16*(1103)

56 58*(1438)
59 11/16*(1516)
54 1/8*(1375)
53 3/8*(1356)
47 7/16*(1205)

64 58*(1641)
67 11/16*(1719)
62 1/8*(1578)
61 3/8*(1559)
55 7/16*(1408)

94 13/32*(2388)
95 15/16*(2437)
92 3/4*(2356)
92*(2337)
84 3/8*(2143)

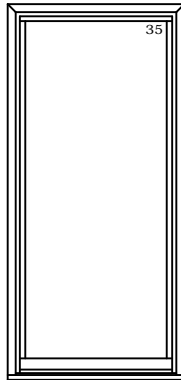

CWDP4192

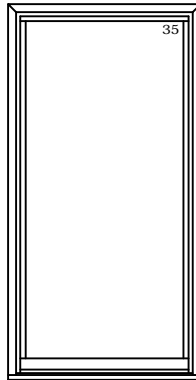

CWDP4592

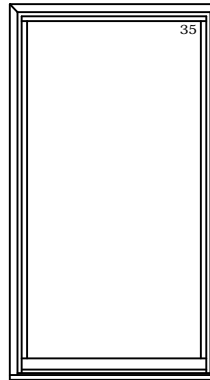

CWDP4992

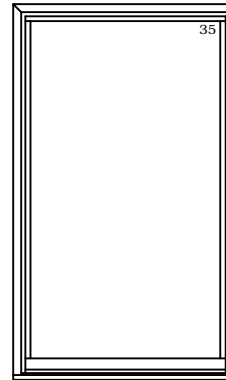

CWDP5392

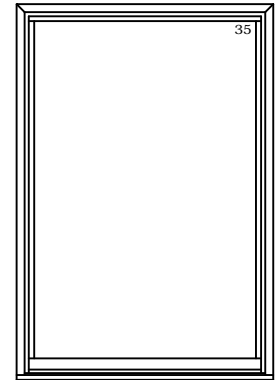

CWDP6192

98 13/32*(2500)
99 15/16*(2538)
96 3/4*(2457)
96*(2438)
88 3/8*(2245)

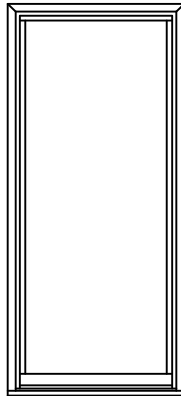

CWDP4196

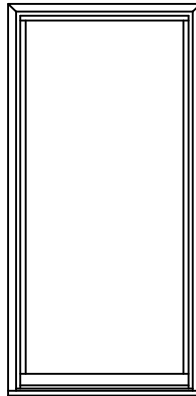

CWDP4596

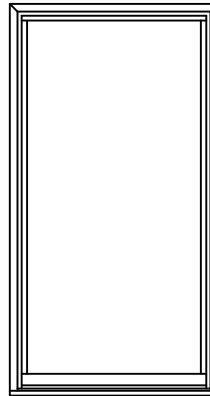

CWDP4996

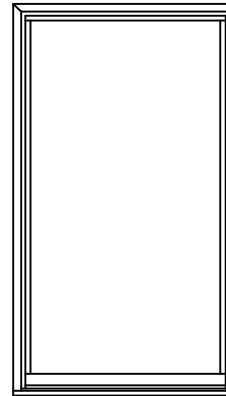

CWDP5396

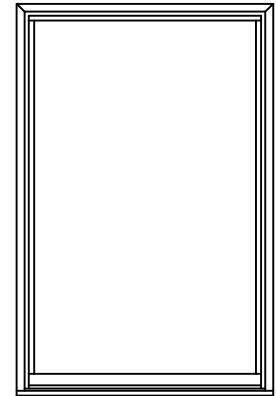

CWDP6196

ELEVATION SYMBOL LEGEND:

- M.O. = MASORNY OPENING
- VALUES IN () ARE IN MILLIMETER CONVERSIONS
- T BASIC UNIT IS NOT AVAILABLE WITH TRI-PANE GLASS.
- ## NUMBER INDICATES DESIGN PRESSURE (DP) RATING WITH STANDARD GLASS.
- ##* NUMBER INDICATES HIGHER DP RATING, TALLER SILL STOP AND IMPACT GLAZING.

Note: Elevations shown DO NOT have exterior trim. Subtract 1/2"(12.7) from M.O.(Masonry Opening) for Unit Sizes. Masonry openings above include Sill Nose, see Trim Options page for Sill Nose specifications. For other Trim Options refer to the Unit Sizing, Rough Opening & Masonry Openings page.

PICTURE UNITS
ELEVATIONS

MO BRICKMOLD
MO FLAT CASING
ROUGH OPENING
FRAME SIZE
DAYLIGHT OPENING

72 5/8"(1845)
75 11/16"(1922)
70 1/8"(1781)
69 3/8"(1762)
63 7/16"(1611)

80 5/8"(2048)
83 11/16"(2126)
78 1/8"(1984)
77 3/8"(1965)
71 7/16"(1815)

42 13/32"(1077)
43 15/16"(1116)
40 3/4"(1035)
40"(1016)
32 3/8"(822)

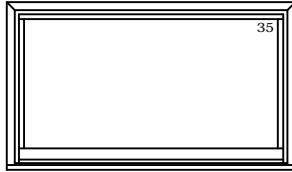

CWDP6940

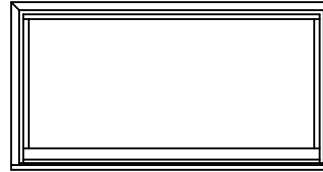

CWDP7740

46 13/32"(1179)
47 15/16"(1218)
44 3/4"(1137)
44"(1118)
36 3/8"(924)

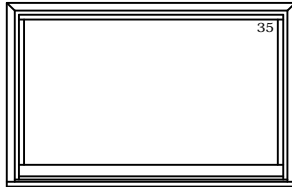

CWDP6944

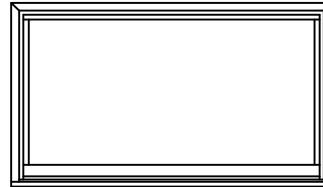

CWDP7744

50 13/32"(1280)
51 15/16"(1319)
48 3/4"(1238)
48"(1219)
40 3/8"(1026)

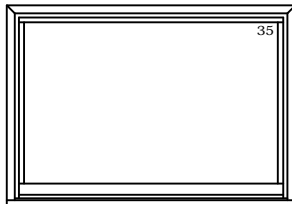

CWDP6948

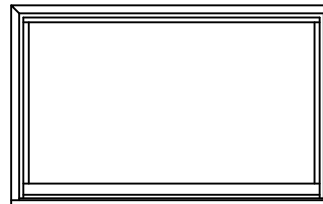

CWDP7748

54 13/32"(1382)
55 15/16"(1421)
52 3/4"(1340)
52"(1321)
44 3/8"(1127)

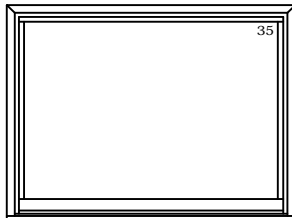

CWDP6952

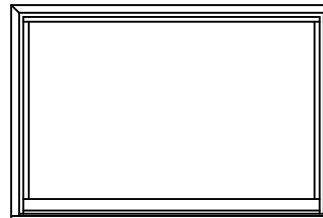

CWDP7752

58 13/32"(1484)
59 15/16"(1522)
56 3/4"(1441)
56"(1422)
48 3/8"(1229)

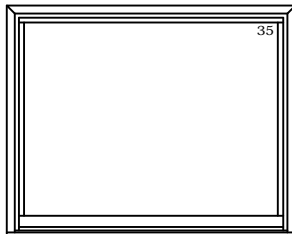

CWDP6956

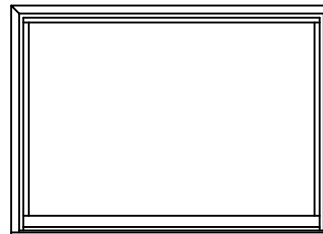

CWDP7756

62 13/32"(1585)
63 15/16"(1624)
60 3/4"(1543)
60"(1524)
52 3/8"(1330)

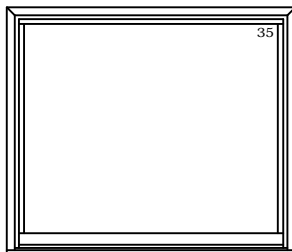

CWDP6960

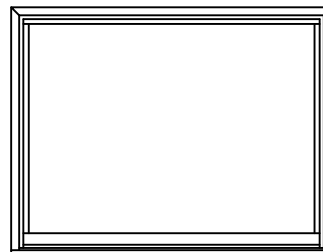

CWDP7760

ELEVATION SYMBOL LEGEND:

- M.O. = MASORNY OPENING
- VALUES IN () ARE IN MILLIMETER CONVERSIONS
- T BASIC UNIT IS NOT AVAILBLE WITH TRI-PANE GLASS.
- ## NUMBER INDICATES DESIGN PRESSURE (DP) RATING WITH STANDARD GLASS.
- ##* NUMBER INDICATES HIGHER DP RATING, TALLER SILL STOP AND IMPACT GLAZING.

Note: Elevations shown DO NOT have exterior trim. Subtract 1/2"(12.7) from M.O.(Masonry Opening) for Unit Sizes. Masonry openings above include Sill Nose, see Trim Options page for Sill Nose specifications. For other Trim Options refer to the Unit Sizing, Rough Opening & Masonry Openings page.

PICTURE UNITS
ELEVATIONS

MO BRICKMOLD
MO FLAT CASING
ROUGH OPENING
FRAME SIZE
DAYLIGHT OPENING

72 5/8"(1845)
75 11/16"(1922)
70 1/8"(1781)
69 3/8"(1762)
63 7/16"(1611)

80 5/8"(2048)
83 11/16"(2126)
78 1/8"(1984)
77 3/8"(1965)
71 7/16"(1815)

66 13/32"(1687)
67 15/16"(1726)
64 3/4"(1645)
64"(1626)
56 3/8"(1432)

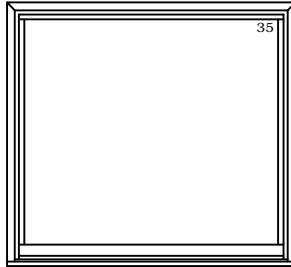

CWDP6964

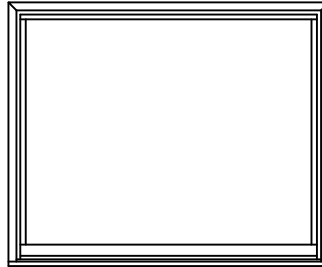

CWDP7764

70 13/32"(1788)
71 15/16"(1827)
68 3/4"(1746)
68"(1727)
60 3/8"(1534)

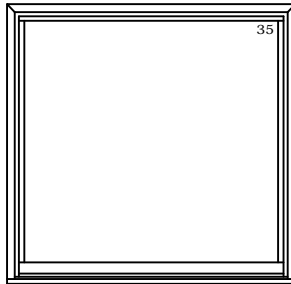

CWDP6968

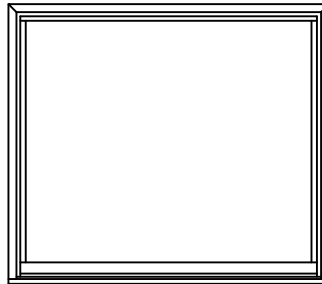

CWDP7768

74 13/32"(1890)
75 15/16"(1929)
72 3/4"(1848)
72"(1829)
64 3/8"(1635)

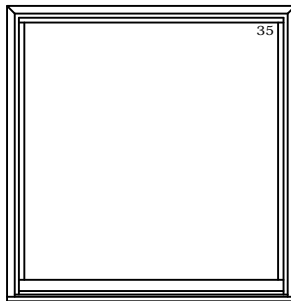

CWDP6972

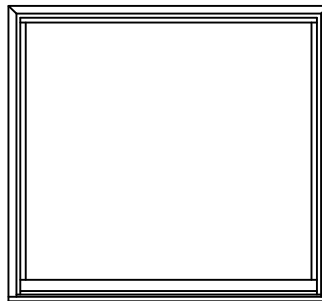

CWDP7772

ELEVATION SYMBOL LEGEND:

- M.O. = MASORNY OPENING
- VALUES IN () ARE IN MILLIMETER CONVERSIONS
- T BASIC UNIT IS NOT AVAILABLE WITH TRI-PANE GLASS.
- ## NUMBER INDICATES DESIGN PRESSURE (DP) RATING WITH STANDARD GLASS.
- ##* NUMBER INDICATES HIGHER DP RATING, TALLER SILL STOP AND IMPACT GLAZING.

Note: Elevations shown DO NOT have exterior trim. Subtract 1/2"(12.7) from M.O.(Masonry Opening) for Unit Sizes. Masonry openings above include Sill Nose, see Trim Options page for Sill Nose specifications. For other Trim Options refer to the Unit Sizing, Rough Opening & Masonry Openings page.

PICTURE UNITS
ELEVATIONS

MO BRICKMOLD
MO FLAT CASING
ROUGH OPENING
FRAME SIZE
DAYLIGHT OPENING

72 58"(1845)
75 11/16"(1922)
70 1/8"(1781)
69 3/8"(1762)
63 7/16"(1611)

80 58"(2048)
83 11/16"(2126)
78 1/8"(1984)
77 3/8"(1965)
71 7/16"(1815)

78 13/32"(1994)
79 15/16"(2030)
76 3/4"(1949)
76"(1930)
68 3/8"(1737)

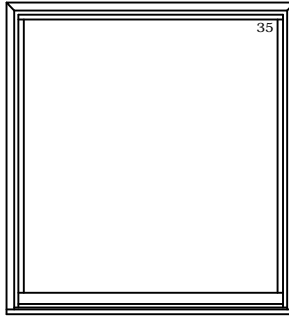

CWDP6976

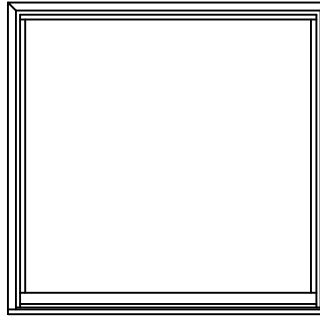

CWDP7776

82 13/32"(2053)
83 15/16"(2132)
80 3/4"(2051)
80"(2032)
72 11/16"(1838)

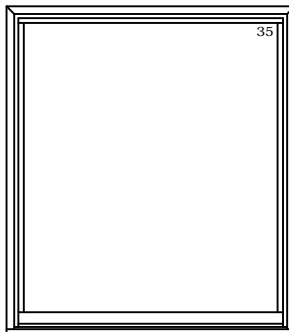

CWDP6980

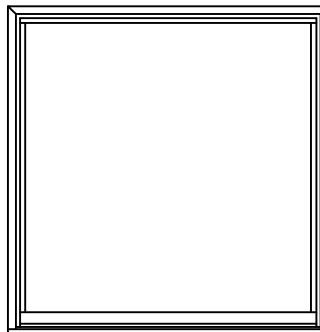

CWDP7780

80 13/32"(2296)
91 15/16"(2335)
88 3/4"(2254)
88"(2235)
80 3/8"(2042)

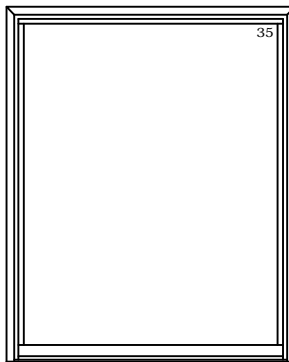

CWDP6988

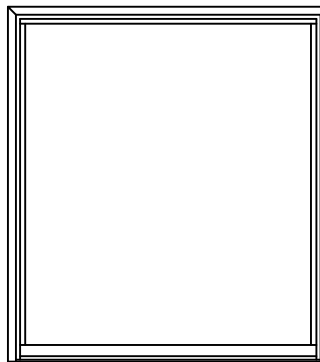

CWDP7788

ELEVATION SYMBOL LEGEND:

- M.O. = MASORNY OPENING
- VALUES IN () ARE IN MILLIMETER CONVERSIONS
- T' BASIC UNIT IS NOT AVAILABLE WITH TRI-PANE GLASS.
- ## NUMBER INDICATES DESIGN PRESSURE (DP) RATING WITH STANDARD GLASS.
- ##* NUMBER INDICATES HIGHER DP RATING, TALLER SILL STOP AND IMPACT GLAZING.

Note: Elevations shown DO NOT have exterior trim. Subtract 1/2"(12.7) from M.O.(Masonry Opening) for Unit Sizes. Masonry openings above include Sill Nose, see Trim Options page for Sill Nose specifications. For other Trim Options refer to the Unit Sizing, Rough Opening & Masonry Openings page.

PICTURE UNITS
ELEVATIONS

MO BRICKMOLD
MO FLAT CASING
ROUGH OPENING
FRAME SIZE
DAYLIGHT OPENING

72 58"(1845)
75 11/16"(1922)
70 1/8"(1781)
69 3/8"(1762)
63 7/16"(1611)

80 58"(2048)
83 11/16"(2126)
78 1/8"(1984)
77 3/8"(1965)
71 7/16"(1815)

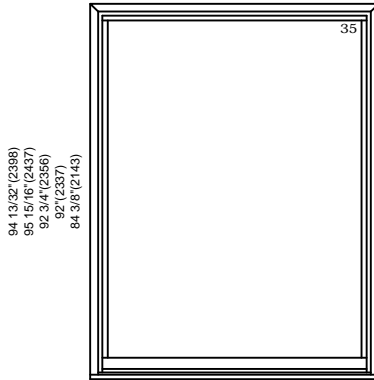

CWDP6992

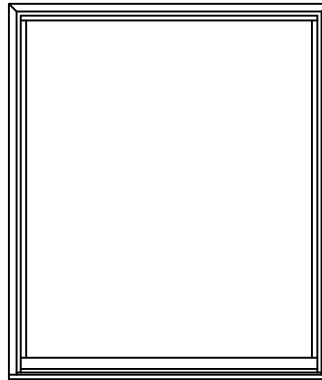

CWDP7792

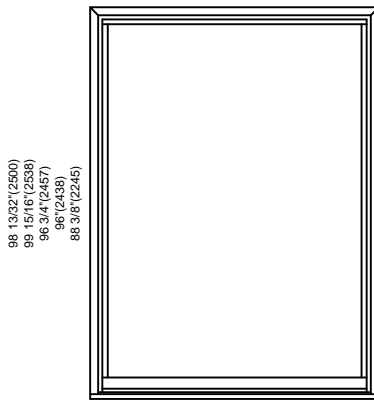

CWDP6996

ELEVATION SYMBOL LEGEND:

- M.O. = MASORNY OPENING
- VALUES IN () ARE IN MILLIMETER CONVERSIONS
- T BASIC UNIT IS NOT AVAILABLE WITH TRI-PANE GLASS.
- ## NUMBER INDICATES DESIGN PRESSURE (DP) RATING WITH STANDARD GLASS.
- ##* NUMBER INDICATES HIGHER DP RATING, TALLER SILL STOP AND IMPACT GLAZING.

Note: Elevations shown DO NOT have exterior trim. Subtract 1/2"(12.7) from M.O.(Masonry Opening) for Unit Sizes. Masonry openings above include Sill Nose, see Trim Options page for Sill Nose specifications. For other Trim Options refer to the Unit Sizing, Rough Opening & Masonry Openings page.

2 WIDE UNITS
ELEVATIONS

	46"(1168)	54"(1372)	62"(1575)	66"(1676)	70"(1778)	74"(1880)	78"(1981)
MO BRICKMOLD	49 1/16"(1246)	57 1/16"(1449)	64 1/16"(1627)	68 1/16"(1729)	72 1/16"(1830)	76 1/16"(1932)	80 1/16"(2034)
MO FLAT CASING	43 1/2"(1105)	51 1/2"(1308)	59 1/2"(1511)	63 1/2"(1613)	67 1/2"(1715)	71 1/2"(1816)	75 1/2"(1918)
ROUGH OPENING	42 3/4"(1086)	50 3/4"(1289)	58 3/4"(1492)	62 3/4"(1594)	66 3/4"(1695)	70 3/4"(1797)	74 3/4"(1899)
FRAME SIZE							
DAYLIGHT OPENING	15 7/16"[2](392)[2]	19 7/16"[2](494)[2]	23 7/16"[2](595)[2]	25 7/16"[2](646)[2]	27 7/16"[2](697)[2]	29 7/16"[2](748)[2]	31 7/16"[2](799)[2]

34 13/32"(874) 35 15/16"(913) 33 3/4"(832) 33 3/4"(832) 11 1/8"(283)							
38 13/32"(976) 39 15/16"(1014) 38 3/4"(933) 36 9/14" 13 1/8"(333)							
42 13/32"(1077) 43 15/16"(1115) 40 3/4"(1035) 40 3/4"(1035) 15 1/8"(384)							
46 13/32"(1179) 47 15/16"(1216) 44 3/4"(1137) 44 1/4"(1118) 17 1/8"(435)							
50 13/32"(1280) 51 15/16"(1318) 48 3/4"(1238) 48 1/2"(1219) 19 1/8"(486)							
54 13/32"(1382) 55 15/16"(1421) 52 3/4"(1340) 52 1/2"(1321) 21 1/8"(537)							
58 13/32"(1484) 59 15/16"(1522) 56 3/4"(1441) 56 1/2"(1422) 23 1/8"(587)							
62 13/32"(1585) 63 15/16"(1624) 60 3/4"(1543) 60 1/2"(1524) 25 1/8"(638)							
66 13/32"(1687) 67 15/16"(1726) 64 3/4"(1645) 64 1/2"(1626) 27 1/8"(689)							

ELEVATION SYMBOL LEGEND:

- M.O. = MASORNY OPENING
- VALUES IN () ARE IN MILLIMETER CONVERSIONS
- VALUES IN [] ARE NUMBER OF DAYLIGHT OPENINGS PER UNIT
- E UNIT MEETS EGRESS REQUIREMENT FOR IRC CODE. STATE AND LOCAL EGRESS CODES MAY DIFFER. ALWAYS REFER TO LOCAL BUILDING CODES FOR COMPLETE REQUIREMENTS. CHECK WITH LOCAL OFFICIALS TO ENSURE COMPLIANCE BEFORE INSTALLING THE UNIT.
- E1 BASIC UNIT CLEAR OPENING EXCEEDS 20" IN WIDTH, 24" IN HEIGHT & A MINIMUM OF 5.0 SQ. FT., FOR FIRST FLOOR EGRESS.
- T BASIC UNIT IS NOT AVAILABLE WITH TRI-PANE GLASS.
- ## NUMBER INDICATES DESIGN PRESSURE (DP) RATING WITH STANDARD GLASS.
- ### NUMBER INDICATES HIGHER DP RATING, TALLER SILL STOP AND IMPACT GLAZING.

Note: Elevations shown DO NOT have exterior trim. Subtract 1/2"(12.7) from M.O.(Masonry Opening) for Unit Sizes. Masonry openings above include Sill Nose, see Trim Options page for Sill Nose specifications. For other Trim Options refer to the Unit Sizing, Rough Opening & Masonry Openings page.

2 WIDE UNITS
ELEVATIONS

	46"(1168)	54"(1372)	62"(1575)	66"(1676)	70"(1778)	74"(1880)	78"(1981)
MO BRICKMOLD							
MO FLAT CASING	49 1/16"(1246)	57 1/16"(1449)	64 1/16"(1627)	68 1/16"(1729)	72 1/16"(1830)	76 1/16"(1932)	80 1/16"(2034)
ROUGH OPENING	43 1/2"(1105)	51 1/2"(1308)	59 1/2"(1511)	63 1/2"(1613)	67 1/2"(1715)	71 1/2"(1816)	75 1/2"(1918)
FRAME SIZE	42 3/4"(1086)	50 3/4"(1289)	58 3/4"(1492)	62 3/4"(1594)	66 3/4"(1695)	70 3/4"(1797)	74 3/4"(1899)
DAYLIGHT OPENING	15 7/16"[2](392)[2]	19 7/16"[2](494)[2]	23 7/16"[2](595)[2]	25 7/16"[2](646)[2]	27 7/16"[2](697)[2]	29 7/16"[2](748)[2]	31 7/16"[2](799)[2]
70 13/32"(1788)							
71 15/16"(1827)							
68 3/4"(1746)							
66"(1727)							
29 1/8"(740)							
74 13/32"(1890)							
75 15/16"(1929)							
72 3/4"(1848)							
72"(1829)							
31 1/8"(791)							
78 13/32"(1984)							
79 15/16"(1990)							
76 3/4"(1949)							
76"(1930)							
33 1/8"(841)							
82 13/32"(2093)							
83 15/16"(2132)							
80 3/4"(2051)							
80"(2032)							
35 1/8"(892)							
90 13/32"(2296)							
91 15/16"(2335)							
88 3/4"(2254)							
88"(2235)							
39 1/8"(994)							







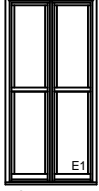

ELEVATION SYMBOL LEGEND:

- M.O. = MASORNY OPENING
- VALUES IN () ARE IN MILLIMETER CONVERSIONS
- VALUES IN [] ARE NUMBER OF DAYLIGHT OPENINGS PER UNIT
- E UNIT MEETS EGRESS REQUIREMENT FOR IRC CODE. STATE AND LOCAL EGRESS CODES MAY DIFFER. ALWAYS REFER TO LOCAL BUILDING CODES FOR COMPLETE REQUIREMENTS. CHECK WITH LOCAL OFFICIALS TO ENSURE COMPLIANCE BEFORE INSTALLING THE UNIT.
- E1 BASIC UNIT CLEAR OPENING EXCEEDS 20" IN WIDTH, 24" IN HEIGHT & A MINIMUM OF 5.0 SQ. FT., FOR FIRST FLOOR EGRESS.
- T BASIC UNIT IS NOT AVAILABLE WITH TRI-PANE GLASS.
- ## NUMBER INDICATES DESIGN PRESSURE (DP) RATING WITH STANDARD GLASS.
- ##* NUMBER INDICATES HIGHER DP RATING, TALLER SILL STOP AND IMPACT GLAZING.

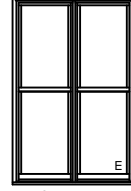
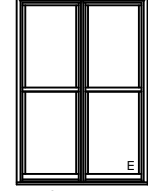
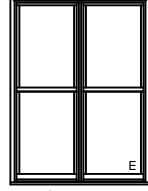
Note: Elevations shown DO NOT have exterior trim. Subtract 1/2"(12.7) from M.O. (Masonry Opening) for Unit Sizes. Masonry openings above include Sill Nose, see Trim Options page for Sill Nose specifications. For other Trim Options refer to the Unit Sizing, Rough Opening & Masonry Openings page.

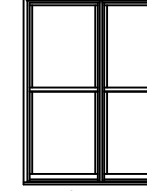
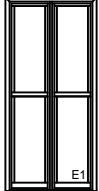
2 WIDE UNITS
ELEVATIONS

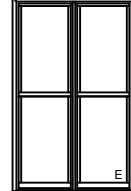
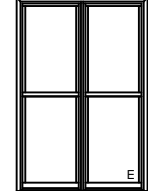
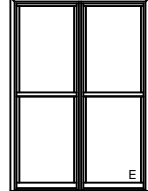
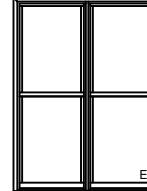
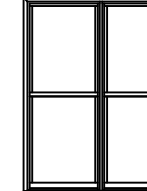
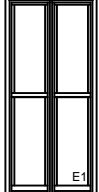
MO BRICKMOLD	46"(1168)	54"(1372)	62"(1575)	66"(1676)	70"(1778)	74"(1880)	78"(1981)
MO FLAT CASING	49 1/16"(1246)	57 1/16"(1449)	64 1/16"(1627)	68 1/16"(1729)	72 1/16"(1830)	76 1/16"(1932)	80 1/16"(2034)
ROUGH OPENING	43 1/2"(1105)	51 1/2"(1308)	59 1/2"(1511)	63 1/2"(1613)	67 1/2"(1715)	71 1/2"(1816)	75 1/2"(1918)
FRAME SIZE	42 3/4"(1086)	50 3/4"(1289)	58 3/4"(1492)	62 3/4"(1594)	66 3/4"(1695)	70 3/4"(1797)	74 3/4"(1899)
DAYLIGHT OPENING	15 7/16"2 (392) 2	19 7/16"2 (494) 2	23 7/16"2 (595) 2	25 7/16"2 (646) 2	27 7/16"2 (697) 2	29 7/16"2 (748) 2	31 7/16"2 (799) 2

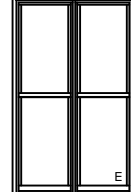
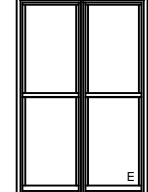
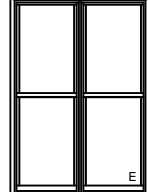
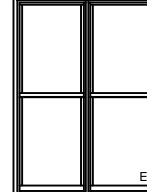
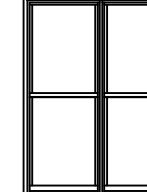
<p>94 13/32"(2398) 95 15/16"(2437) 92 3/4"(2356) 92"(2337) 41 1/8"(1045)</p>  <p>CWD2192-2</p>	 <p>CWD2592-2</p>	 <p>CWD2992-2</p>	 <p>CWD3192-2</p>	 <p>CWD3392-2</p>	 <p>CWD3592-2</p>	 <p>CWD3792-2</p>
<p>98 13/32"(2500) 99 15/16"(2539) 96 3/4"(2457) 96"(2438) 43 1/8"(1095)</p>  <p>CWD2196-2</p>	 <p>CWD2596-2</p>	 <p>CWD2996-2</p>	 <p>CWD3196-2</p>	 <p>CWD3396-2</p>	 <p>CWD3596-2</p>	 <p>CWD3796-2</p>
<p>100 13/32"(2560) 101 15/16"(2599) 98 3/4"(2517) 98"(2498) 44 1/8"(1146)</p>  <p>CWD2198-2</p>	 <p>CWD2598-2</p>	 <p>CWD2998-2</p>	 <p>CWD3198-2</p>	 <p>CWD3398-2</p>	 <p>CWD3598-2</p>	 <p>CWD3798-2</p>

ELEVATION SYMBOL LEGEND:
M.O. = MASONRY OPENING
VALUES IN () ARE IN MILLIMETER CONVERSIONS
VALUES IN [] ARE NUMBER OF DAYLIGHT OPENINGS PER UNIT
E UNIT MEETS EGRESS REQUIREMENT FOR IRC CODE. STATE AND LOCAL EGRESS CODES MAY DIFFER. ALWAYS REFER TO LOCAL BUILDING CODES FOR COMPLETE REQUIREMENTS. CHECK WITH LOCAL OFFICIALS TO ENSURE COMPLIANCE BEFORE INSTALLING THE UNIT.
E1 BASIC UNIT CLEAR OPENING EXCEEDS 20" IN WIDTH, 24" IN HEIGHT & A MINIMUM OF 5.0 SQ. FT., FOR FIRST FLOOR EGRESS.
T BASIC UNIT IS NOT AVAILABLE WITH TRI-PANE GLASS.
NUMBER INDICATES DESIGN PRESSURE (DP) RATING WITH STANDARD GLASS.
NUMBER INDICATES HIGHER DP RATING, TALLER SILL STOP AND IMPACT GLAZING.

Note: Elevations shown DO NOT have exterior trim. Subtract 1/2"(12.7) from M.O.(Masonry Opening) for Unit Sizes. Masonry openings above include Sill Nose, see Trim Options page for Sill Nose specifications. For other Trim Options refer to the Unit Sizing, Rough Opening & Masonry Openings page.

2 WIDE UNITS
ELEVATIONS

MO BRICKMOLD
MO FLAT CASING
ROUGH OPENING
FRAME SIZE
DAYLIGHT OPENING

86"(2184)
88 1/16"(2237)
83 1/2"(2121)
82 3/4"(2102)
35 7/16"[2](900)[2]

94"(2388)
96 1/16"(2440)
91 1/2"(2324)
90 3/4"(2305)
39 7/16"[2](1002)[2]

102"(2591)
104 1/16"(2643)
99 1/2"(2527)
98 3/4"(2508)
43 7/16"[2](1103)[2]

34 13/32"(874)
35 15/16"(913)
32 3/4"(832)
32"(813)
11 1/8"(283)

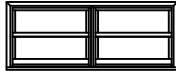

CWD4132-2

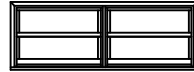

CWD4532-2

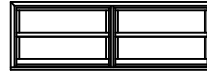

CWD4932-2

38 13/32"(976)
39 15/16"(1014)
36 3/4"(933)
36"(914)
13 1/8"(333)



CWD4136-2



CWD4536-2



CWD4936-2

42 13/32"(1077)
43 15/16"(1116)
40 3/4"(1035)
40"(1016)
15 1/8"(384)



CWD4140-2



CWD4540-2



CWD4940-2

46 13/32"(1179)
47 15/16"(1218)
44 3/4"(1137)
44"(1118)
17 1/8"(435)



CWD4144-2



CWD4544-2



CWD4944-2

50 13/32"(1280)
51 15/16"(1319)
48 3/4"(1238)
48"(1219)
19 1/8"(486)



CWD4148-2



CWD4548-2



CWD4948-2

54 13/32"(1382)
55 15/16"(1421)
52 3/4"(1340)
52"(1321)
21 1/8"(537)



CWD4152-2



CWD4552-2



CWD4952-2

58 13/32"(1484)
59 15/16"(1522)
56 3/4"(1441)
56"(1422)
23 1/8"(587)

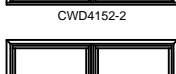

CWD4156-2

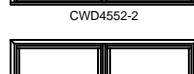

CWD4556-2



CWD4956-2

62 13/32"(1585)
63 15/16"(1624)
60 3/4"(1543)
60"(1524)
25 1/8"(638)

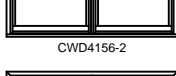

CWD4160-2

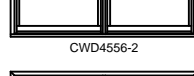

CWD4560-2

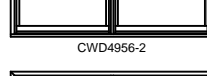

CWD4960-2

66 13/32"(1687)
67 15/16"(1726)
64 3/4"(1645)
64"(1626)
27 1/8"(689)



CWD4164-2



CWD4564-2



CWD4964-2

70 13/32"(1788)
71 15/16"(1827)
68 3/4"(1746)
68"(1727)
29 1/8"(740)



CWD4168-2



CWD4568-2



CWD4968-2

ELEVATION SYMBOL LEGEND:

- M.O. = MASONRY OPENING
- VALUES IN () ARE IN MILLIMETER CONVERSIONS
- VALUES IN [] ARE NUMBER OF DAYLIGHT OPENINGS PER UNIT
- E UNIT MEETS EGRESS REQUIREMENT FOR IRC CODE. STATE AND LOCAL EGRESS CODES MAY DIFFER. ALWAYS REFER TO LOCAL BUILDING CODES FOR COMPLETE REQUIREMENTS. CHECK WITH LOCAL OFFICIALS TO ENSURE COMPLIANCE BEFORE INSTALLING THE UNIT.
- E1 BASIC UNIT CLEAR OPENING EXCEEDS 20" IN WIDTH, 24" IN HEIGHT & A MINIMUM OF 5.0 SQ. FT., FOR FIRST FLOOR EGRESS.
- T BASIC UNIT IS NOT AVAILABLE WITH TRI-PANE GLASS.
- ## NUMBER INDICATES DESIGN PRESSURE (DP) RATING WITH STANDARD GLASS.
- ##* NUMBER INDICATES HIGHER DP RATING, TALLER SILL STOP AND IMPACT GLAZING.

Note: Elevations shown DO NOT have exterior trim. Subtract 1/2"(12.7) from M.O.(Masonry Opening) for Unit Sizes. Masonry openings above include Sill Nose, see Trim Options page for Sill Nose specifications. For other Trim Options refer to the Unit Sizing, Rough Opening & Masonry Openings page.

2 WIDE UNITS
ELEVATIONS

MO BRICKMOLD
MO FLAT CASING
ROUGH OPENING
FRAME SIZE
DAYLIGHT OPENING

86*(2184)
88 1/16*(2237)
83 1/2*(2121)
82 3/4*(2102)
35 7/16*[2](900)[2]

94*(2388)
96 1/16*(2440)
91 1/2*(2324)
90 3/4*(2305)
39 7/16*[2](1002)[2]

102*(2591)
104 1/16*(2643)
99 1/2*(2527)
98 3/4*(2508)
43 7/16*[2](1103)[2]

74 13/32*(1890)
75 15/16*(1929)
72 3/4*(1848)
72*(1828)
31 1/8*(791)

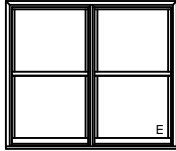

CWD4172-2

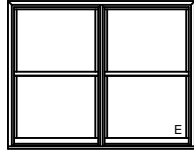

CWD4572-2

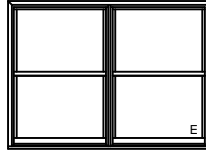

CWD4972-2

78 13/32*(1994)
79 15/16*(2030)
76 3/4*(1949)
76*(1930)
33 1/8*(841)

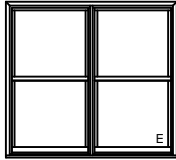

CWD4176-2

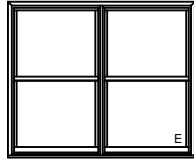

CWD4576-2

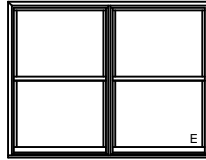

CWD4976-2

82 13/32*(2093)
83 15/16*(2132)
80 3/4*(2051)
80*(2032)
35 1/8*(892)

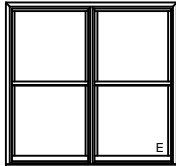

CWD4180-2

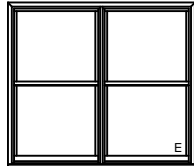

CWD4580-2

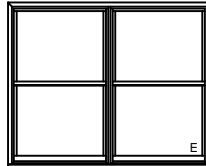

CWD4980-2

90 13/32*(2286)
91 15/16*(2335)
88 3/4*(2254)
88*(2235)
39 1/8*(994)

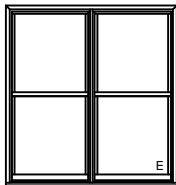

CWD4188-2

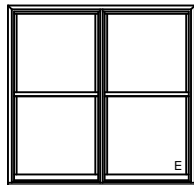

CWD4588-2

94 13/32*(2389)
95 15/16*(2437)
92 3/4*(2356)
92*(2337)
41 1/8*(1045)

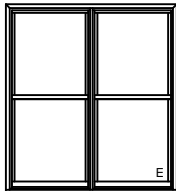

CWD4192-2

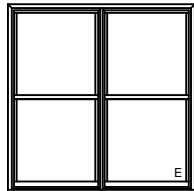

CWD4592-2

98 13/32*(2500)
99 15/16*(2538)
96 3/4*(2457)
96*(2438)
43 7/8*(1095)

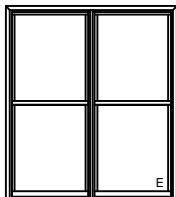

CWD4196-2

ELEVATION SYMBOL LEGEND:

- M.O. = MASORNY OPENING
- VALUES IN () ARE IN MILLIMETER CONVERSIONS
- VALUES IN [] ARE NUMBER OF DAYLIGHT OPENINGS PER UNIT
- E UNIT MEETS EGRESS REQUIREMENT FOR IRC CODE. STATE AND LOCAL EGRESS CODES MAY DIFFER. ALWAYS REFER TO LOCAL BUILDING CODES FOR COMPLETE REQUIREMENTS. CHECK WITH LOCAL OFFICIALS TO ENSURE COMPLIANCE BEFORE INSTALLING THE UNIT.
- E1 BASIC UNIT CLEAR OPENING EXCEEDS 20" IN WIDTH, 24" IN HEIGHT & A MINIMUM OF 5.0 SQ. FT., FOR FIRST FLOOR EGRESS.
- T BASIC UNIT IS NOT AVAILABLE WITH TRI-PANE GLASS.
- ## NUMBER INDICATES DESIGN PRESSURE (DP) RATING WITH STANDARD GLASS.
- ##* NUMBER INDICATES HIGHER DP RATING, TALLER SILL STOP AND IMPACT GLAZING.

Note: Elevations shown DO NOT have exterior trim. Subtract 1/2"(12.7) from M.O.(Masonry Opening) for Unit Sizes. Masonry openings above include Sill Nose, see Trim Options page for Sill Nose specifications. For other Trim Options refer to the Unit Sizing, Rough Opening & Masonry Openings page.

3 WIDE UNITS
ELEVATIONS

MO BRICKMOLD MO FLAT CASING ROUGH OPENING FRAME SIZE DAYLIGHT OPENING	67 3/8"(1711) 70 7/16"(1789) 64 7/8"(1648) 64 1/8"(1629) 15 7/16"[3](392)[3]	79 3/8"(2016) 82 7/16"(2094) 76 7/8"(1946) 76 1/8"(1934) 19 7/16"[3](494)[3]	91 3/8"(2321) 94 7/16"(2399) 88 7/8"(2257) 88 1/8"(2238) 23 7/16"[3](595)[3]	97 3/8"(2473) 100 7/16"(2551) 94 7/8"(2410) 94 1/8"(2391) 25 7/16"[3](646)[3]	103 3/8"(2626) 106 7/16"(2704) 100 7/8"(2556) 100 1/8"(2543) 27 7/16"[3](697)[3]
34 13/32"(874) 35 15/16"(913) 32 3/4"(832) 32 3/4"(832) 11 1/8"(283)					
38 13/32"(976) 39 15/16"(1014) 36 3/4"(933) 36 3/4"(934) 13 1/8"(333)					
42 13/32"(1077) 43 15/16"(1115) 40 3/4"(1035) 40 3/4"(1036) 15 1/8"(384)					
46 13/32"(1179) 47 15/16"(1218) 44 3/4"(1137) 44 1/4"(1118) 17 1/8"(435)					
50 13/32"(1280) 51 15/16"(1319) 48 3/4"(1238) 48 1/4"(1219) 19 1/8"(486)					
54 13/32"(1382) 55 15/16"(1421) 52 3/4"(1340) 52 1/4"(1321) 21 1/8"(537)					
58 13/32"(1484) 59 15/16"(1522) 56 3/4"(1441) 56 1/4"(1422) 23 1/8"(587)					
62 13/32"(1585) 63 15/16"(1624) 60 3/4"(1543) 60 1/4"(1524) 25 1/8"(638)					
66 13/32"(1687) 67 15/16"(1726) 64 3/4"(1645) 64 1/4"(1626) 27 1/8"(688)					
70 13/32"(1788) 71 15/16"(1827) 68 3/4"(1746) 68 1/4"(1727) 29 1/8"(740)					

ELEVATION SYMBOL LEGEND:

- M.O. = MASORNY OPENING
- VALUES IN () ARE IN MILLIMETER CONVERSIONS
- VALUES IN [] ARE NUMBER OF DAYLIGHT OPENINGS PER UNIT
- E UNIT MEETS EGRESS REQUIREMENT FOR IRC CODE. STATE AND LOCAL EGRESS CODES MAY DIFFER. ALWAYS REFER TO LOCAL BUILDING CODES FOR COMPLETE REQUIREMENTS. CHECK WITH LOCAL OFFICIALS TO ENSURE COMPLIANCE BEFORE INSTALLING THE UNIT.
- E1 BASIC UNIT CLEAR OPENING EXCEEDS 20" IN WIDTH, 24" IN HEIGHT & A MINIMUM OF 5.0 SQ. FT., FOR FIRST FLOOR EGRESS.
- T BASIC UNIT IS NOT AVAILABLE WITH TRI-PANE GLASS.
- ## NUMBER INDICATES DESIGN PRESSURE (DP) RATING WITH STANDARD GLASS.
- ### NUMBER INDICATES HIGHER DP RATING, TALLER SILL STOP AND IMPACT GLAZING.

Note: Elevations shown DO NOT have exterior trim. Subtract 1/2"(12.7) from M.O.(Masonry Opening) for Unit Sizes. Masonry openings above include Sill Nose, see Trim Options page for Sill Nose specifications. For other Trim Options refer to the Unit Sizing, Rough Opening & Masonry Openings page.

3 WIDE UNITS
ELEVATIONS

MO BRICKMOLD
MO FLAT CASING
ROUGH OPENING
FRAME SIZE
DAYLIGHT OPENING

67 3/8"(1711)
70 7/16"(1789)
64 7/8"(1648)
64 1/8"(1629)
15 7/16"[3](392)[3]

79 3/8"(2016)
82 7/16"(2094)
76 7/8"(1946)
76 1/8"(1934)
19 7/16"[3](494)[3]

91 3/8"(2321)
94 7/16"(2399)
88 7/8"(2257)
88 1/8"(2238)
23 7/16"[3](695)[3]

97 3/8"(2473)
100 7/16"(2551)
94 7/8"(2410)
94 1/8"(2391)
25 7/16"[3](646)[3]

103 3/8"(2626)
106 7/16"(2704)
100 7/8"(2556)
100 1/8"(2543)
27 7/16"[3](697)[3]

74 13/32"(1890)
75 15/16"(1929)
72 3/4"(1848)
72"(1829)
31 1/8"(791)

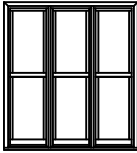

CWD2172-3

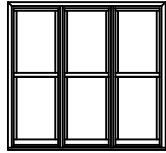

CWD2572-3

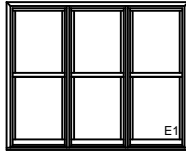

CWD2972-3

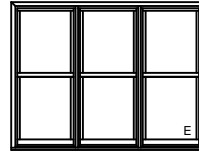

CWD3172-3

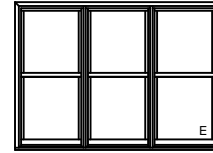

CWD3372-3

78 13/32"(1994)
79 15/16"(2030)
76 3/4"(1949)
76"(1930)
33 1/8"(841)

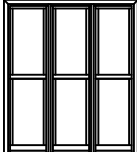

CWD2176-3

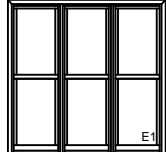

CWD2576-3



CWD2976-3

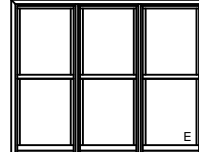

CWD3176-3

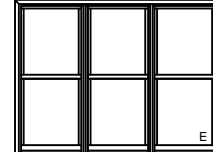

CWD3376-3

82 13/32"(2093)
83 15/16"(2132)
80 3/4"(2051)
80"(2032)
35 1/8"(892)

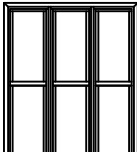

CWD2180-3

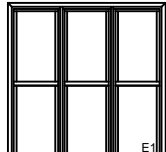

CWD2580-3

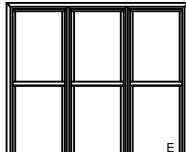

CWD2980-3

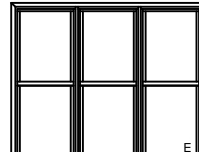

CWD3180-3

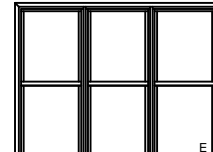

CWD3380-3

90 13/32"(2296)
91 15/16"(2335)
88 3/4"(2254)
88"(2235)
39 1/8"(994)

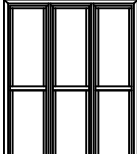

CWD2188-3

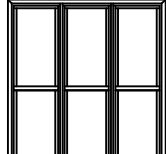

CWD2588-3

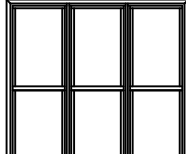

CWD2988-3

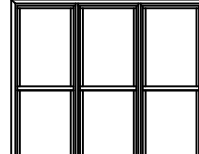

CWD3188-3



CWD3388-3

94 13/32"(2398)
95 15/16"(2437)
92 3/4"(2356)
92"(2337)
41 1/8"(1045)

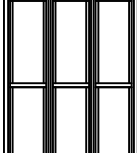

CWD2192-3

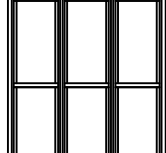

CWD2592-3

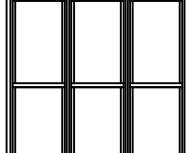

CWD2992-3

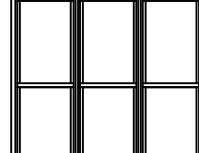

CWD3192-3

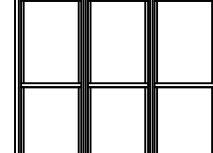

CWD3392-3

98 13/32"(2500)
99 15/16"(2538)
96 3/4"(2457)
96"(2438)
43 1/8"(1095)

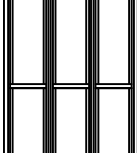

CWD2196-3

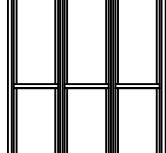

CWD2596-3

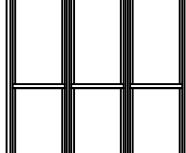

CWD2996-3

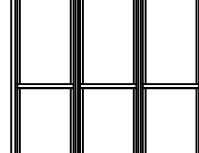

CWD3196-3

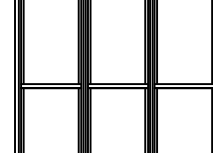

CWD3396-3

100 13/32"(2650)
101 15/16"(2689)
98 3/4"(2608)
98"(2489)
44 1/8"(1146)



CWD2198-3

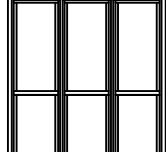

CWD2598-3



CWD2998-3



CWD3198-3



CWD3398-3

ELEVATION SYMBOL LEGEND:

M.O. = MASORNY OPENING
VALUES IN () ARE IN MILLIMETER CONVERSIONS
VALUES IN [] ARE NUMBER OF DAYLIGHT OPENINGS PER UNIT
E UNIT MEETS EGRESS REQUIREMENT FOR IRC CODE. STATE AND LOCAL EGRESS CODES MAY DIFFER. ALWAYS REFER TO LOCAL BUILDING CODES FOR COMPLETE REQUIREMENTS. CHECK WITH LOCAL OFFICIALS TO ENSURE COMPLIANCE BEFORE INSTALLING THE UNIT.
E1 BASIC UNIT CLEAR OPENING EXCEEDS 20" IN WIDTH, 24" IN HEIGHT & A MINIMUM OF 5.0 SQ. FT., FOR FIRST FLOOR EGRESS.
T BASIC UNIT IS NOT AVAILABLE WITH TRI-PANE GLASS.
NUMBER INDICATES DESIGN PRESSURE (DP) RATING WITH STANDARD GLASS.
NUMBER INDICATES HIGHER DP RATING, TALLER SILL STOP AND IMPACT GLAZING.
Note: Elevations shown DO NOT have exterior trim. Subtract 1/2"(12.7) from M.O.(Masonry Opening) for Unit Sizes. Masonry openings above include Sill Nose, see Trim Options page for Sill Nose specifications. For other Trim Options refer to the Unit Sizing, Rough Opening & Masonry Openings page.

3 WIDE UNITS
ELEVATIONS

MO BRICKMOLD
MO FLAT CASING
ROUGH OPENING
FRAME SIZE
DAYLIGHT OPENING

109 3/8"(2778)
112 7/16"(2856)
106 7/8"(2715)
106 1/8"(2696)
29 7/16"[3](748)[3]

115 3/8"(2931)
118 7/16"(3008)
112 7/8"(2867)
112 1/8"(2848)
31 7/16"[3](799)[3]

127 3/8"(3235)
130 7/16"(3313)
124 7/8"(3172)
124 1/8"(3153)
35 7/16"[3](900)[3]

139 3/8"(3540)
142 7/16"(3618)
136 7/8"(3477)
136 1/8"(3458)
39 7/16"[3](1002)[3]

34 13/32"(674)
35 15/16"(913)
32 3/4"(832)
32"(813)
11 1/8"(283)

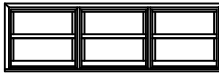

CWD3532-3

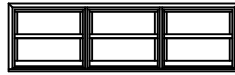

CWD3732-3

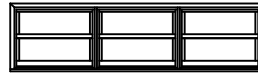

CWD4132-3

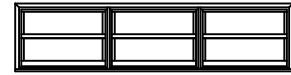

CWD4532-3

38 13/32"(976)
39 15/16"(1014)
36 3/4"(933)
36"(914)
13 1/8"(333)



CWD3536-3



CWD3736-3



CWD4136-3



CWD4536-3

42 13/32"(1077)
43 15/16"(1116)
40 3/4"(1035)
40"(1016)
15 1/8"(384)



CWD3540-3



CWD3740-3



CWD4140-3



CWD4540-3

46 13/32"(1179)
47 15/16"(1218)
44 3/4"(1137)
44"(1118)
17 1/8"(435)



CWD3544-3



CWD3744-3



CWD4144-3



CWD4544-3

50 13/32"(1280)
51 15/16"(1319)
48 3/4"(1238)
48"(1219)
19 1/8"(486)



CWD3548-3



CWD3748-3



CWD4148-3



CWD4548-3

54 13/32"(1382)
55 15/16"(1421)
52 3/4"(1340)
52"(1321)
21 1/8"(537)



CWD3552-3



CWD3752-3



CWD4152-3



CWD4552-3

58 13/32"(1484)
59 15/16"(1522)
56 3/4"(1441)
56"(1422)
23 1/8"(587)



CWD3556-3



CWD3756-3

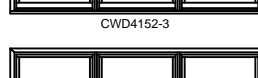

CWD4156-3

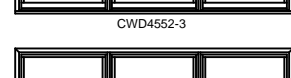

CWD4556-3

62 13/32"(1585)
63 15/16"(1624)
60 3/4"(1543)
60"(1524)
25 1/8"(638)



CWD3560-3



CWD3760-3



CWD4160-3



CWD4560-3

66 13/32"(1687)
67 15/16"(1726)
64 3/4"(1645)
64"(1626)
27 1/8"(689)



CWD3564-3



CWD3764-3



CWD4164-3



CWD4564-3

70 13/32"(1788)
71 15/16"(1827)
68 3/4"(1746)
68"(1727)
29 1/8"(740)

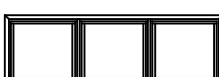

CWD3568-3

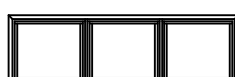

CWD3768-3



CWD4168-3



CWD4568-3

ELEVATION SYMBOL LEGEND:

- M.O. = MASORNY OPENING
- VALUES IN () ARE IN MILLIMETER CONVERSIONS
- VALUES IN [] ARE NUMBER OF DAYLIGHT OPENINGS PER UNIT
- E UNIT MEETS EGRESS REQUIREMENT FOR IRC CODE. STATE AND LOCAL EGRESS CODES MAY DIFFER. ALWAYS REFER TO LOCAL BUILDING CODES FOR COMPLETE REQUIREMENTS. CHECK WITH LOCAL OFFICIALS TO ENSURE COMPLIANCE BEFORE INSTALLING THE UNIT.
- E1 BASIC UNIT CLEAR OPENING EXCEEDS 20" IN WIDTH, 24" IN HEIGHT & A MINIMUM OF 5.0 SQ. FT., FOR FIRST FLOOR EGRESS.
- T BASIC UNIT IS NOT AVAILABLE WITH TRI-PANE GLASS.
- ## NUMBER INDICATES DESIGN PRESSURE (DP) RATING WITH STANDARD GLASS.
- ##* NUMBER INDICATES HIGHER DP RATING, TALLER SILL STOP AND IMPACT GLAZING.

Note: Elevations shown DO NOT have exterior trim. Subtract 1/2"(12.7) from M.O.(Masonry Opening) for Unit Sizes. Masonry openings above include Sill Nose, see Trim Options page for Sill Nose specifications. For other Trim Options refer to the Unit Sizing, Rough Opening & Masonry Openings page.

3 WIDE UNITS
ELEVATIONS

MO BRICKMOLD
MO FLAT CASING
ROUGH OPENING
FRAME SIZE
DAYLIGHT OPENING

109 3/8"(2778)
112 7/16"(2856)
106 7/8"(2715)
106 1/8"(2696)
29 7/16"[3](748)[3]

115 3/8"(2931)
118 7/16"(3008)
112 7/8"(2867)
112 1/8"(2848)
31 7/16"[3](799)[3]

127 3/8"(3235)
130 7/16"(3313)
124 7/8"(3172)
124 1/8"(3153)
35 7/16"[3](900)[3]

139 3/8"(3540)
142 7/16"(3618)
136 7/8"(3477)
136 1/8"(3458)
39 7/16"[3](1002)[3]

<p>74 13/32"(1890) 75 15/16"(1929) 72 3/4"(1948) 72"(1829) 31 1/8"(791)</p>				
<p>78 13/32"(1944) 79 15/16"(2030) 76 3/4"(1949) 76"(1930) 33 1/8"(841)</p>				
<p>82 13/32"(2093) 83 15/16"(2132) 80 3/4"(2051) 80"(2032) 35 1/8"(892)</p>				
<p>90 13/32"(2286) 91 15/16"(2335) 88 3/4"(2254) 88"(2235) 39 1/8"(994)</p>				
<p>94 13/32"(2398) 95 15/16"(2437) 92 3/4"(2356) 92"(2337) 41 1/8"(1045)</p>				
<p>98 13/32"(2500) 99 15/16"(2538) 96 3/4"(2457) 96"(2438) 43 1/8"(1095)</p>				
<p>100 13/32"(2550) 101 15/16"(2589) 98 3/4"(2508) 98"(2489) 44 1/8"(1146)</p>				

ELEVATION SYMBOL LEGEND:

M.O. = MASONRY OPENING
VALUES IN () ARE IN MILLIMETER CONVERSIONS
VALUES IN [] ARE NUMBER OF DAYLIGHT OPENINGS PER UNIT
E UNIT MEETS EGRESS REQUIREMENT FOR IRC CODE. STATE AND LOCAL EGRESS CODES MAY DIFFER. ALWAYS REFER TO LOCAL BUILDING CODES FOR COMPLETE REQUIREMENTS. CHECK WITH LOCAL OFFICIALS TO ENSURE COMPLIANCE BEFORE INSTALLING THE UNIT.
E1 BASIC UNIT CLEAR OPENING EXCEEDS 20" IN WIDTH, 24" IN HEIGHT & A MINIMUM OF 5.0 SQ. FT., FOR FIRST FLOOR EGRESS.
T BASIC UNIT IS NOT AVAILABLE WITH TRI-PANE GLASS.
NUMBER INDICATES DESIGN PRESSURE (DP) RATING WITH STANDARD GLASS.
NUMBER INDICATES HIGHER DP RATING, TALLER SILL STOP AND IMPACT GLAZING.
Note: Elevations shown DO NOT have exterior trim. Subtract 1/2"(12.7) from M.O.(Masonry Opening) for Unit Sizes. Masonry openings above include Sill Nose, see Trim Options page for Sill Nose specifications. For other Trim Options refer to the Unit Sizing, Rough Opening & Masonry Openings page.

TRANSOM UNITS
ELEVATIONS

MO BRICKMOLD	24 5/8"(625)	28 5/8"(727)	32 5/8"(829)	34 5/8"(879)	36 5/8"(930)	38 5/8"(981)	40 5/8"(1032)
MO FLAT CASING	27 11/16"(703)	31 11/16"(805)	35 11/16"(906)	37 11/16"(957)	39 11/16"(1008)	41 11/16"(1059)	43 11/16"(1110)
ROUGH OPENING	22 1/8"(562)	26 1/8"(664)	30 1/8"(765)	32 1/8"(816)	34 1/8"(867)	36 1/8"(918)	38 1/8"(968)
FRAME SIZE	21 3/8"(543)	25 3/8"(645)	29 3/8"(746)	31 3/8"(797)	33 3/8"(848)	35 3/8"(899)	37 3/8"(949)
DAYLIGHT OPENING	15 7/16"(392)	19 7/16"(494)	23 7/16"(595)	25 7/16"(646)	27 7/16"(697)	29 7/16"(748)	31 7/16"(798)
14 13/32"(368) 15 15/16"(406) 12 3/4"(324) 12 1/2"(309) 5 5/8"(143)							
16 13/32"(417) 17 15/16"(456) 14 3/4"(375) 14 1/4"(360) 7 5/8"(194)							
18 13/32"(468) 19 15/16"(506) 16 3/4"(425) 16 1/4"(410) 9 5/8"(244)							
20 13/32"(519) 21 15/16"(557) 18 3/4"(476) 18 1/4"(461) 11 5/8"(295)							
22 13/32"(569) 23 15/16"(608) 20 3/4"(527) 20 1/4"(512) 13 5/8"(346)							
26 13/32"(671) 27 15/16"(710) 24 3/4"(629) 24 1/4"(614) 17 5/8"(448)							
32 13/32"(823) 33 15/16"(862) 30 3/4"(781) 30 1/4"(766) 23 5/8"(600)							
38 13/32"(976) 39 15/16"(1014) 36 3/4"(933) 36 1/4"(918) 29 5/8"(752)							
44 13/32"(1128) 45 15/16"(1167) 42 3/4"(1086) 42 1/4"(1071) 35 5/8"(905)							
50 13/32"(1280) 51 15/16"(1319) 48 3/4"(1238) 48 1/4"(1223) 41 5/8"(1057)							

ELEVATION SYMBOL LEGEND:

M.O. = MASORNY OPENING
 VALUES IN () ARE IN MILLIMETER CONVERSIONS
 ## NUMBER INDICATES DESIGN PRESSURE (DP) RATING WITH STANDARD GLAZING.
 ### NUMBER INDICATES HIGHER DP RATING WITH IMPACT GLAZING.
 Note: Elevations shown DO NOT have exterior trim. Subtract 1/2"(12.7) from M.O.(Masonry Opening) for Unit Sizes. Masonry openings above include Sill Nose, see Trim Options page for Sill Nose specifications. For other Trim Options refer to the Unit Sizing, Rough Opening & Masonry Openings page.

TRANSOM UNITS
ELEVATIONS

44 5/8"(113) 47 11/16"(1211) 42 1/8"(1070) 41 3/8"(1051) 35 7/16"(900)	48 5/8"(1235) 51 11/16"(1313) 46 1/8"(1172) 45 3/8"(1153) 39 7/16"(1002)	52 5/8"(1337) 55 11/16"(1414) 50 1/8"(1273) 49 3/8"(1254) 43 7/16"(1103)	56 5/8"(1438) 59 11/16"(1516) 54 1/8"(1375) 53 3/8"(1356) 47 7/16"(1205)	64 5/8"(1641) 67 11/16"(1719) 62 1/8"(1578) 61 3/8"(1559) 55 7/16"(1408)
14 13/32"(368) 17 15/16"(466) 12 3/4"(324) 12"(305) 5 5/8"(143)				
16 13/32"(417) 17 15/16"(466) 14 3/4"(375) 14"(366) 7 5/8"(194)				
18 13/32"(468) 19 15/16"(506) 16 3/4"(425) 16"(406) 9 5/8"(244)				
20 13/32"(518) 21 15/16"(557) 18 3/4"(476) 18"(457) 11 5/8"(295)				
22 13/32"(569) 23 15/16"(608) 20 3/4"(527) 20"(508) 13 5/8"(346)				
26 13/32"(671) 27 15/16"(710) 24 3/4"(629) 24"(610) 17 5/8"(448)				
32 13/32"(823) 33 15/16"(862) 30 3/4"(781) 30"(762) 23 5/8"(600)				
38 13/32"(976) 39 15/16"(1014) 36 3/4"(933) 36"(914) 29 5/8"(752)				
44 13/32"(1128) 45 15/16"(1167) 42 3/4"(1086) 42"(1067) 35 5/8"(905)				
50 13/32"(1280) 51 15/16"(1319) 48 3/4"(1238) 48"(1219) 41 5/8"(1057)				
CWDT4112	CWDT4512	CWDT4912	CWDT5312	CWDT6112
CWDT4114	CWDT4514	CWDT4914	CWDT5314	CWDT6114
CWDT4116	CWDT4516	CWDT4916	CWDT5316	CWDT6116
CWDT4118	CWDT4518	CWDT4918	CWDT5318	CWDT6118
CWDT4120	CWDT4520	CWDT4920	CWDT5320	CWDT6120
CWDT4124	CWDT4524	CWDT4924	CWDT5324	CWDT6124
CWDT4130	CWDT4530	CWDT4930	CWDT5330	CWDT6130
CWDT4136	CWDT4536	CWDT4936	CWDT5336	CWDT6136
CWDT4142	CWDT4542	CWDT4942	CWDT5342	CWDT6142
CWDT4148	CWDT4548	CWDT4948	CWDT5348	CWDT6148

ELEVATION SYMBOL LEGEND:

- M.O. = MASORNY OPENING
- VALUES IN () ARE IN MILLIMETER CONVERSIONS
- ## NUMBER INDICATES DESIGN PRESSURE (DP) RATING WITH STANDARD GLAZING.
- ### NUMBER INDICATES HIGHER DP RATING WITH IMPACT GLAZING.

Note: Elevations shown DO NOT have exterior trim. Subtract 1/2"(12.7) from M.O.(Masonry Opening) for Unit Sizes. Masonry openings above include Sill Nose, see Trim Options page for Sill Nose specifications. For other Trim Options refer to the Unit Sizing, Rough Opening & Masonry Openings page.

TRANSOM UNITS
ELEVATIONS

MO BRICKMOLD
MO FLAT CASING
ROUGH OPENING
FRAME SIZE
DAYLIGHT OPENING

72 5/8"(1845)
75 11/16"(1922)
70 1/8"(1781)
69 3/8"(1762)
63 7/16"(1611)

80 5/8"(2048)
83 11/16"(2126)
78 1/8"(1984)
77 3/8"(1965)
71 7/16"(1814)

14 13/32"(966)
15 15/16"(406)
12 3/4"(324)
12"(306)
5 5/8"(143)



CWDT6912



CWDT7712

16 13/32"(417)
17 15/16"(466)
14 3/4"(375)
14"(358)
7 5/8"(194)



CWDT6914



CWDT7714

18 13/32"(488)
19 15/16"(506)
16 3/4"(425)
16"(406)
9 5/8"(244)



CWDT6916



CWDT7716

20 13/32"(518)
21 15/16"(557)
18 3/4"(476)
18"(457)
11 5/8"(295)

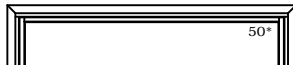

CWDT6918



CWDT7716

22 13/32"(569)
23 15/16"(608)
20 3/4"(527)
20"(508)
13 5/8"(346)

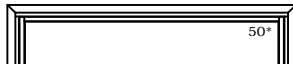

CWDT6920

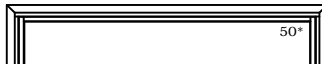

CWDT7720

26 13/32"(671)
27 15/16"(710)
24 3/4"(629)
24"(610)
17 5/8"(448)



CWDT6924



CWDT7724

32 13/32"(823)
33 15/16"(862)
30 3/4"(781)
30"(762)
23 5/8"(600)



CWDT6930



CWDT7730

38 13/32"(976)
39 15/16"(1014)
36 3/4"(933)
36"(914)
29 5/8"(752)

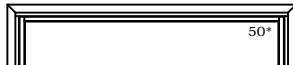

CWDT6936

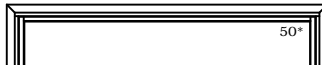

CWDT7736

44 13/32"(1128)
45 15/16"(1167)
42 3/4"(1088)
42"(1067)
35 5/8"(905)



CWDT6942



CWDT7742

50 13/32"(1280)
51 15/16"(1319)
48 3/4"(1238)
48"(1219)
41 5/8"(1057)



CWDT6948







CWDT7748

ELEVATION SYMBOL LEGEND:

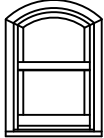
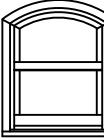
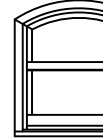
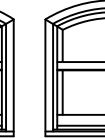
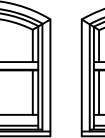
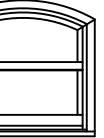
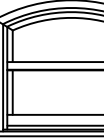
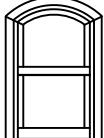
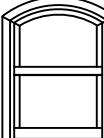
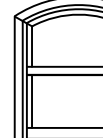
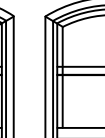
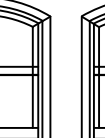
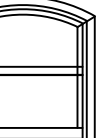
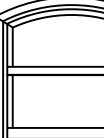
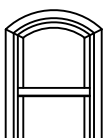
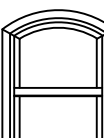
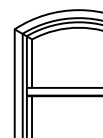
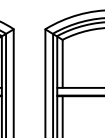
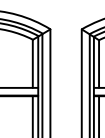
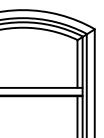
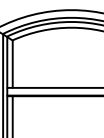
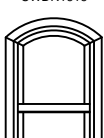
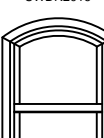
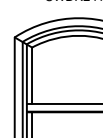
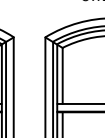
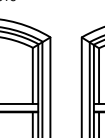
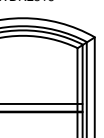
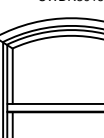
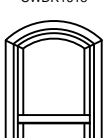
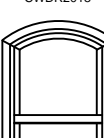
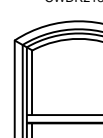
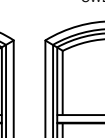
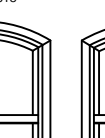
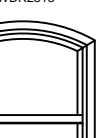
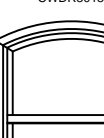
M.O. = MASORNY OPENING
VALUES IN () ARE IN MILLIMETER CONVERSIONS
NUMBER INDICATES DESIGN PRESSURE (DP) RATING WITH STANDARD GLAZING.
NUMBER INDICATES HIGHER DP RATING WITH IMPACT GLAZING.
Note: Elevations shown DO NOT have exterior trim. Subtract 1/2"(12.7) from M.O.(Masonry Opening) for Unit Sizes. Masonry openings above include Sill Nose, see Trim Options page for Sill Nose specifications. For other Trim Options refer to the Unit Sizing, Rough Opening & Masonry Openings page.

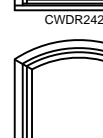
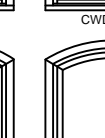
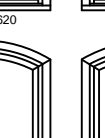
SECTOR TOP UNITS
ELEVATIONS

	24 1/2"(622)	28 1/2"(724)	32 1/2"(826)	34 1/2"(876)	36 1/2"(927)	38 1/2"(978)	40 1/2"(1029)
MO BRICKMOLD	27 9/16"(700)	31 9/16"(802)	35 9/16"(903)	37 9/16"(954)	39 9/16"(1005)	41 9/16"(1056)	43 9/16"(1106)
MO FLAT CASING	22"(589)	26"(660)	30"(762)	32"(813)	34"(864)	36"(914)	38"(965)
ROUGH OPENING	21 1/4"(540)	25 1/4"(641)	29 1/4"(743)	31 1/4"(794)	33 1/4"(845)	35 1/4"(895)	37 1/4"(946)
FRAME SIZE	15 5/16"(389)	19 5/16"(491)	23 5/16"(592)	25 5/16"(643)	27 5/16"(694)	29 5/16"(744)	31 5/16"(795)
DAYLIGHT OPENING							
	34 27/32"(885)						
	36 3/8"(924)						
	33 3/16"(853)						
	32 11/16"(834)						
	11 5/32"(283)						
							
	CWDR1612	CWDR2012	CWDR2412	CWDR2612	CWDR2812	CWDR3012	CWDR3212
	38 27/32"(987)						
	40 3/8"(1026)						
	37 3/16"(935)						
	36 1/8"(926)						
	13 5/32"(334)						
							
	CWDR1614	CWDR2014	CWDR2414	CWDR2614	CWDR2814	CWDR3014	CWDR3214
	42 27/32"(1085)						
	44 3/8"(1127)						
	41 3/16"(1036)						
	40 1/8"(1027)						
	15 5/32"(385)						
							
	CWDR1616	CWDR2016	CWDR2416	CWDR2616	CWDR2816	CWDR3016	CWDR3216
	46 27/32"(1190)						
	48 3/8"(1229)						
	45 3/16"(1141)						
	44 1/8"(1132)						
	17 5/32"(436)						
							
	CWDR1618	CWDR2018	CWDR2418	CWDR2618	CWDR2818	CWDR3018	CWDR3218
	50 27/32"(1291)						
	52 3/8"(1330)						
	49 3/16"(1240)						
	48 1/8"(1231)						
	19 5/32"(487)						
							
	CWDR1620	CWDR2020	CWDR2420	CWDR2620	CWDR2820	CWDR3020	CWDR3220
	54 27/32"(1393)						
	56 3/8"(1432)						
	53 3/16"(1342)						
	52 1/8"(1332)						
	21 5/32"(537)						
							
	CWDR1622	CWDR2022	CWDR2422	CWDR2622	CWDR2822	CWDR3022	CWDR3222

ELEVATION SYMBOL LEGEND:

- M.O. = MASONRY OPENING
- VALUES IN () ARE IN MILLIMETER CONVERSIONS
- E UNIT MEETS EGRESS REQUIREMENT FOR IRC CODE. STATE AND LOCAL EGRESS CODES MAY DIFFER. ALWAYS REFER TO LOCAL BUILDING CODES FOR COMPLETE REQUIREMENTS. CHECK WITH LOCAL OFFICIALS TO ENSURE COMPLIANCE BEFORE INSTALLING THE UNIT.
- E1 BASIC UNIT CLEAR OPENING EXCEEDS 20" IN WIDTH, 24" IN HEIGHT & A MINIMUM OF 5.0 SQ. FT., FOR FIRST FLOOR EGRESS.
- T BASIC UNIT IS NOT AVAILABLE WITH TRI-PANE GLASS.
- ## NUMBER INDICATES DESIGN PRESSURE (DP) RATING WITH STANDARD GLASS.
- ### NUMBER INDICATES HIGHER DP RATING, TALLER SILL STOP AND IMPACT GLAZING.

Note: Elevations shown DO NOT have exterior trim. Subtract 1/2"(12.7) from M.O.(Masonry Opening) for Unit Sizes. Masonry openings above include Sill Nose, see Trim Options page for Sill Nose specifications. For other Trim Options refer to the Unit Sizing, Rough Opening & Masonry Openings page.

SECTOR TOP UNITS
ELEVATIONS

	24 1/2"(622)	28 1/2"(724)	32 1/2"(826)	34 1/2"(876)	36 1/2"(927)	38 1/2"(978)	40 1/2"(1029)
MO BRICKMOLD	27 9/16"(700)	31 9/16"(802)	35 9/16"(903)	37 9/16"(954)	39 9/16"(1005)	41 9/16"(1056)	43 9/16"(1106)
MO FLAT CASING	22"(589)	26"(660)	30"(762)	32"(813)	34"(864)	36"(914)	38"(965)
ROUGH OPENING	21 1/4"(540)	25 1/4"(641)	29 1/4"(743)	31 1/4"(794)	33 1/4"(845)	35 1/4"(895)	37 1/4"(946)
FRAME SIZE	15 5/16"(389)	19 5/16"(491)	23 5/16"(592)	25 5/16"(643)	27 5/16"(694)	29 5/16"(744)	31 5/16"(795)
DAYLIGHT OPENING							
68 27/32"(1485)							
60 3/8"(1534)							
57 3/16"(1645)							
56 7/16"(1434)							
27"(684)							
23 5/32"(588)							
62 27/32"(1696)							
64 3/8"(1635)							
61 3/16"(1340)							
60 7/16"(1535)							
25"(635)							
15 5/32"(639)							
66 27/32"(1696)							
66 3/8"(1737)							
65 3/16"(1949)							
64 7/16"(1637)							
27"(686)							
27 5/32"(690)							
70 27/32"(1799)							
72 3/8"(1838)							
69 3/16"(1949)							
68 7/16"(1738)							
28"(737)							
29 5/32"(741)							

ELEVATION SYMBOL LEGEND:

- M.O. = MASORNY OPENING
- VALUES IN () ARE IN MILLIMETER CONVERSIONS
- E UNIT MEETS EGRESS REQUIREMENT FOR IRC CODE. STATE AND LOCAL EGRESS CODES MAY DIFFER. ALWAYS REFER TO LOCAL BUILDING CODES FOR COMPLETE REQUIREMENTS. CHECK WITH LOCAL OFFICIALS TO ENSURE COMPLIANCE BEFORE INSTALLING THE UNIT.
- E1 BASIC UNIT CLEAR OPENING EXCEEDS 20" IN WIDTH, 24" IN HEIGHT & A MINIMUM OF 5.0 SQ. FT., FOR FIRST FLOOR EGRESS.
- T BASIC UNIT IS NOT AVAILABLE WITH TRI-PANE GLASS.
- ## NUMBER INDICATES DESIGN PRESSURE (DP) RATING WITH STANDARD GLASS.
- ##* NUMBER INDICATES HIGHER DP RATING, TALLER SILL STOP AND IMPACT GLAZING.

Note: Elevations shown DO NOT have exterior trim. Subtract 1/2"(12.7) from M.O.(Masonry Opening) for Unit Sizes. Masonry openings above include Sill Nose, see Trim Options page for Sill Nose specifications. For other Trim Options refer to the Unit Sizing, Rough Opening & Masonry Openings page.

SECTOR TOP UNITS
ELEVATIONS

	24 1/2"(622)	28 1/2"(724)	32 1/2"(826)	34 1/2"(876)	36 1/2"(927)	38 1/2"(978)	40 1/2"(1029)
MO BRICKMOLD	27 9/16"(700)	31 9/16"(802)	35 9/16"(903)	37 9/16"(954)	39 9/16"(1005)	41 9/16"(1056)	43 9/16"(1106)
MO FLAT CASING	22"(559)	26"(660)	30"(762)	32"(813)	34"(864)	36"(914)	38"(965)
ROUGH OPENING	21 1/4"(540)	25 1/4"(641)	29 1/4"(743)	31 1/4"(794)	33 1/4"(845)	35 1/4"(895)	37 1/4"(946)
FRAME SIZE	15 5/16"(389)	19 5/16"(491)	23 5/16"(592)	25 5/16"(643)	27 5/16"(694)	29 5/16"(744)	31 5/16"(795)
DAYLIGHT OPENING							
	CWDR1632	CWDR2032	CWDR2432	CWDR2632	CWDR2832	CWDR3032	CWDR3232
74 27/32"(1901)							
76 3/8"(1940)							
73 3/16"(1948)							
72 7/16"(1840)							
31"(787)							
31 5/32"(791)							
	CWDR1634	CWDR2034	CWDR2434	CWDR2634	CWDR2834	CWDR3034	CWDR3234
78 27/32"(2003)							
80 3/8"(2042)							
77 3/16"(1949)							
76 7/16"(1842)							
33"(838)							
33 5/32"(842)							
	CWDR1636	CWDR2036	CWDR2436	CWDR2636	CWDR2836	CWDR3036	CWDR3236
82 27/32"(2104)							
84 3/8"(2143)							
81 3/16"(1945)							
80 7/16"(2043)							
35"(889)							
35 5/32"(893)							
	CWDR1640	CWDR2040	CWDR2440	CWDR2640	CWDR2840	CWDR3040	CWDR3240
90 27/32"(2307)							
92 3/8"(2346)							
89 3/16"(1949)							
88 7/16"(2246)							
39"(991)							
39 5/32"(995)							

ELEVATION SYMBOL LEGEND:

M.O. = MASORNY OPENING
 VALUES IN () ARE IN MILLIMETER CONVERSIONS
 E UNIT MEETS EGRESS REQUIREMENT FOR IRC CODE. STATE AND LOCAL EGRESS CODES MAY DIFFER. ALWAYS REFER TO LOCAL BUILDING CODES FOR COMPLETE REQUIREMENTS. CHECK WITH LOCAL OFFICIALS TO ENSURE COMPLIANCE BEFORE INSTALLING THE UNIT.
 E1 BASIC UNIT CLEAR OPENING EXCEEDS 20" IN WIDTH, 24" IN HEIGHT & A MINIMUM OF 5.0 SQ. FT., FOR FIRST FLOOR EGRESS.
 T BASIC UNIT IS NOT AVAILABLE WITH TRI-PANE GLASS.
 ## NUMBER INDICATES DESIGN PRESSURE (DP) RATING WITH STANDARD GLASS.
 ##* NUMBER INDICATES HIGHER DP RATING, TALLER SILL STOP AND IMPACT GLAZING.
 Note: Elevations shown DO NOT have exterior trim. Subtract 1/2"(12.7) from M.O.(Masonry Opening) for Unit Sizes. Masonry openings above include Sill Nose, see Trim Options page for Sill Nose specifications. For other Trim Options refer to the Unit Sizing, Rough Opening & Masonry Openings page.

SECTOR TOP UNITS
ELEVATIONS

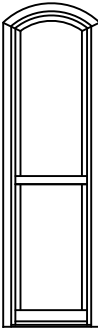
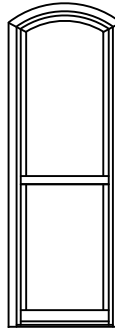
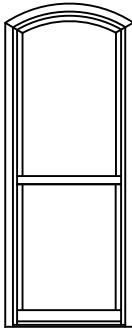
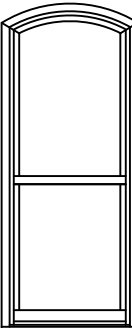
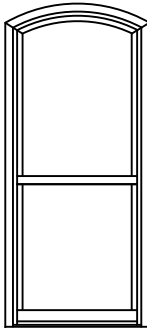
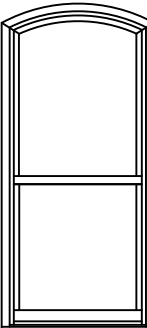
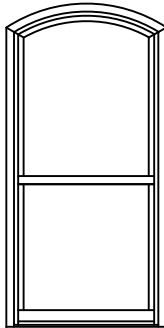
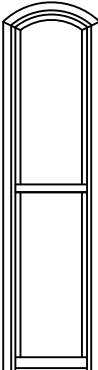
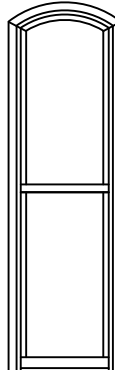
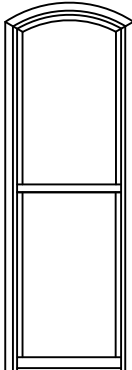
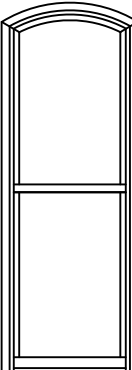
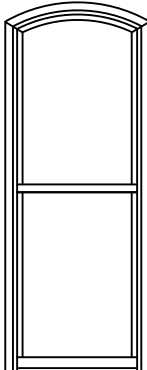
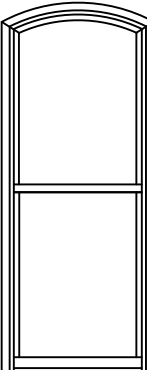
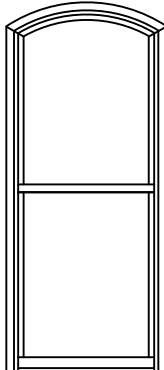
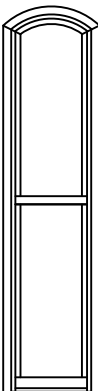
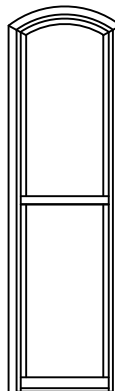
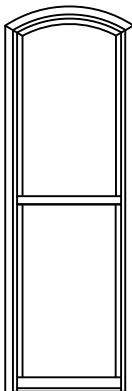
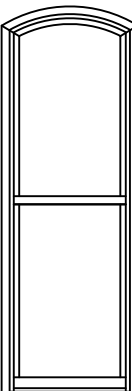
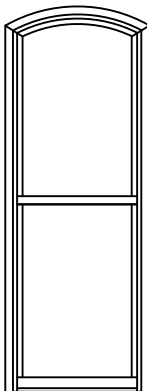
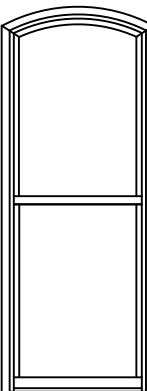
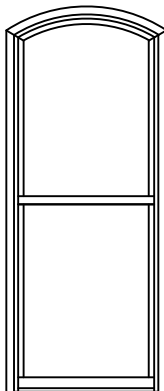
MO BRICKMOLD MO FLAT CASING ROUGH OPENING FRAME SIZE DAYLIGHT OPENING	24 1/2"(622) 27 9/16"(700) 22"(589) 21 1/4"(540) 15 5/16"(389)	28 1/2"(724) 31 9/16"(802) 26"(660) 25 1/4"(641) 19 5/16"(491)	32 1/2"(826) 35 9/16"(903) 30"(762) 29 1/4"(743) 23 5/16"(592)	34 1/2"(876) 37 9/16"(954) 32"(813) 31 1/4"(794) 25 5/16"(643)	36 1/2"(927) 39 9/16"(1005) 34"(864) 33 1/4"(845) 27 5/16"(694)	38 1/2"(978) 41 9/16"(1056) 36"(914) 35 1/4"(895) 29 5/16"(744)	40 1/2"(1029) 43 9/16"(1106) 38"(965) 37 1/4"(946) 31 5/16"(795)
82 27/32"(2104) 84 3/8"(2143) 81 3/16"(1949) 80 7/16"(2043) 38 3/4"(984) 31 7/16"(799)							
	CWDR1640/32	CWDR2040/32	CWDR2440/32	CWDR2640/32	CWDR2840/32	CWDR3040/32	CWDR3240/32
94 27/32"(2409) 96 3/8"(2448) 93 3/16"(1949) 92 7/16"(2348) 41"(1041) 41 5/32"(1045)							
	CWDR1692	CWDR2042	CWDR2442	CWDR2642	CWDR2842	CWDR3042	CWDR3242
98 27/32"(2511) 100 3/8"(2550) 97 3/16"(1949) 96 7/16"(2450) 43 1/8"(1092) 43 5/32"(1096)							
	CWDR1644	CWDR2044	CWDR2444	CWDR2644	CWDR2844	CWDR3044	CWDR3244

ELEVATION SYMBOL LEGEND:

- M.O. = MASORNY OPENING
- VALUES IN () ARE IN MILLIMETER CONVERSIONS
- E. UNIT MEETS EGRESS REQUIREMENT FOR IRC CODE. STATE AND LOCAL EGRESS CODES MAY DIFFER. ALWAYS REFER TO LOCAL BUILDING CODES FOR COMPLETE REQUIREMENTS. CHECK WITH LOCAL OFFICIALS TO ENSURE COMPLIANCE BEFORE INSTALLING THE UNIT.
- E1 BASIC UNIT CLEAR OPENING EXCEEDS 20" IN WIDTH, 24" IN HEIGHT & A MINIMUM OF 5.0 SQ. FT., FOR FIRST FLOOR EGRESS.
- T BASIC UNIT IS NOT AVAILABLE WITH TRI-PANE GLASS.
- ## NUMBER INDICATES DESIGN PRESSURE (DP) RATING WITH STANDARD GLASS.
- ##* NUMBER INDICATES HIGHER DP RATING, TALLER SILL STOP AND IMPACT GLAZING.

Note: Elevations shown DO NOT have exterior trim. Subtract 1/2"(12.7) from M.O.(Masonry Opening) for Unit Sizes. Masonry openings above include Sill Nose, see Trim Options page for Sill Nose specifications. For other Trim Options refer to the Unit Sizing, Rough Opening & Masonry Openings page.

SECTOR TOP UNITS
ELEVATIONS

MO BRICKMOLD
MO FLAT CASING
ROUGH OPENING
FRAME SIZE
DAYLIGHT OPENING

44 1/2"(1130)
47 9/16"(1208)
42"(1067)
41 1/4"(1048)
35 5/16"(897)

48 1/2"(1232)
51 9/16"(1310)
46"(1168)
45 1/4"(1149)
39 5/16"(999)

52 1/2"(1334)
55 9/16"(1411)
50"(1270)
49 1/4"(1251)
43 5/16"(1100)

34 27/32"(885)
36 3/8"(924)
33 3/16"(933)
32 7/16"(824)
11 1/2"(279)
11 5/32"(283)

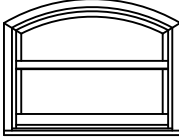

CWDR3612



CWDR4012

38 27/32"(987)
40 3/8"(1026)
37 3/16"(1035)
36 7/16"(926)
13"(330)
13 5/32"(334)

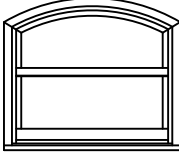

CWDR3614

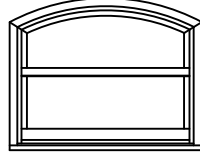

CWDR4014

42 27/32"(1088)
44 3/8"(1127)
41 3/16"(1238)
40 7/16"(1027)
15"(381)
15 5/32"(385)

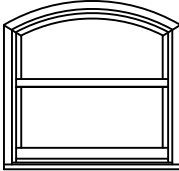

CWDR3616

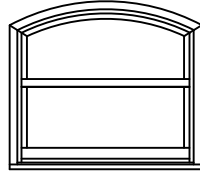

CWDR4016

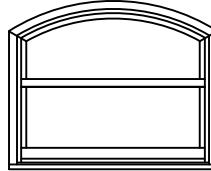

CWDR4416

46 27/32"(1190)
48 3/8"(1229)
45 3/16"(1441)
44 7/16"(1129)
17"(432)
17 5/32"(436)

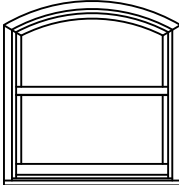

CWDR3618

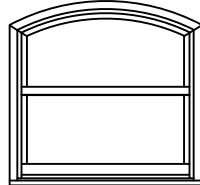

CWDR4018

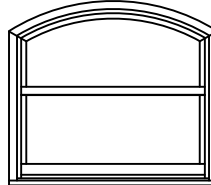

CWDR4418

50 27/32"(1291)
52 3/8"(1330)
49 3/16"(1340)
48 7/16"(1230)
19"(483)
19 5/32"(487)

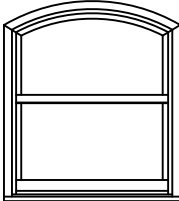

CWDR3620

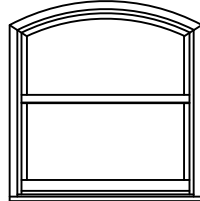

CWDR4020

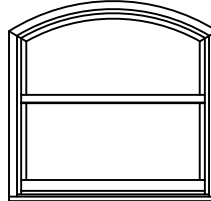

CWDR4420

54 27/32"(1393)
56 3/8"(1432)
53 3/16"(1746)
52 7/16"(1332)
21"(533)
21 5/32"(537)

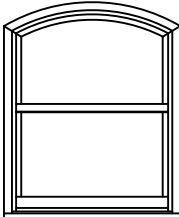

CWDR3622

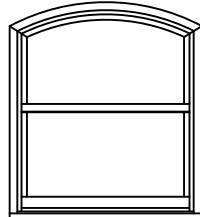

CWDR4022

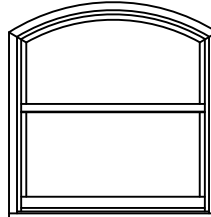

CWDR4422

ELEVATION SYMBOL LEGEND:

- M.O. = MASORNY OPENING
- VALUES IN () ARE IN MILLIMETER CONVERSIONS
- E UNIT MEETS EGRESS REQUIREMENT FOR IRC CODE. STATE AND LOCAL EGRESS CODES MAY DIFFER. ALWAYS REFER TO LOCAL BUILDING CODES FOR COMPLETE REQUIREMENTS. CHECK WITH LOCAL OFFICIALS TO ENSURE COMPLIANCE BEFORE INSTALLING THE UNIT.
- E1 BASIC UNIT CLEAR OPENING EXCEEDS 20" IN WIDTH, 24" IN HEIGHT & A MINIMUM OF 5.0 SQ. FT., FOR FIRST FLOOR EGRESS.
- T BASIC UNIT IS NOT AVAILABLE WITH TRI-PANE GLASS.
- ## NUMBER INDICATES DESIGN PRESSURE (DP) RATING WITH STANDARD GLASS.
- ### NUMBER INDICATES HIGHER DP RATING, TALLER SILL STOP AND IMPACT GLAZING.

Note: Elevations shown DO NOT have exterior trim. Subtract 1/2"(12.7) from M.O.(Masonry Opening) for Unit Sizes. Masonry openings above include Sill Nose, see Trim Options page for Sill Nose specifications. For other Trim Options refer to the Unit Sizing, Rough Opening & Masonry Openings page.

SECTOR TOP UNITS
ELEVATIONS

MO BRICKMOLD
MO FLAT CASING
ROUGH OPENING
FRAME SIZE
DAYLIGHT OPENING

44 1/2"(1130)
47 9/16"(1208)
42"(1067)
41 1/4"(1048)
35 5/16"(897)

48 1/2"(1232)
51 9/16"(1310)
46"(1168)
45 1/4"(1149)
39 5/16"(999)

52 1/2"(1334)
55 9/16"(1411)
50"(1270)
49 1/4"(1251)
43 5/16"(1100)

68 27/32"(1495)
60 3/8"(1534)
57 3/16"(1445)
56 7/16"(1434)
23"(584)
23 5/32"(588)

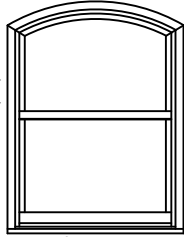

CWDR3624

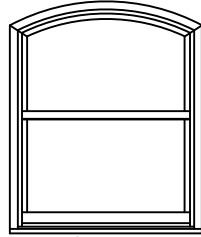

CWDR4024

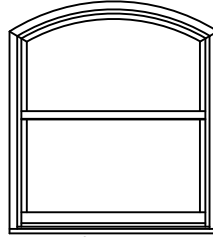

CWDR4424

62 27/32"(1596)
64 3/8"(1635)
61 3/16"(1540)
60 7/16"(1535)
25"(635)
15 5/32"(639)

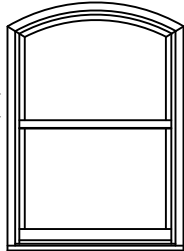

CWDR3626

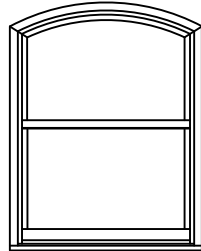

CWDR4026

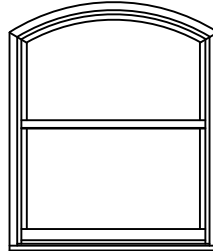

CWDR4426

66 27/32"(1698)
68 3/8"(1737)
65 3/16"(1640)
64 7/16"(1637)
27"(686)
27 5/32"(690)

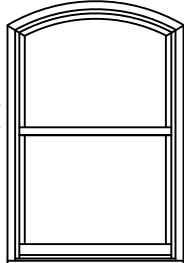

CWDR3628

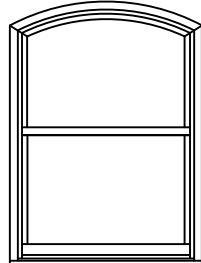

CWDR4028

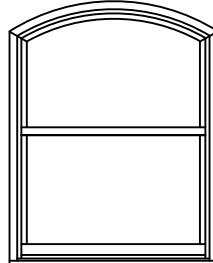

CWDR4428

70 27/32"(1799)
72 3/8"(1838)
69 3/16"(1740)
68 7/16"(1738)
29"(737)
29 5/32"(741)

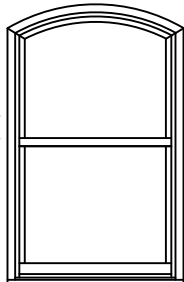

CWDR3630

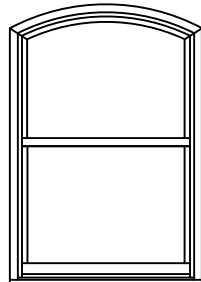

CWDR4030

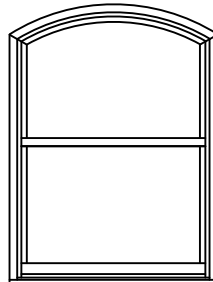

CWDR4430

ELEVATION SYMBOL LEGEND:

- M.O. = MASORNY OPENING
- VALUES IN () ARE IN MILLIMETER CONVERSIONS
- E UNIT MEETS EGRESS REQUIREMENT FOR IRC CODE. STATE AND LOCAL EGRESS CODES MAY DIFFER. ALWAYS REFER TO LOCAL BUILDING CODES FOR COMPLETE REQUIREMENTS. CHECK WITH LOCAL OFFICIALS TO ENSURE COMPLIANCE BEFORE INSTALLING THE UNIT.
- E1 BASIC UNIT CLEAR OPENING EXCEEDS 20" IN WIDTH, 24" IN HEIGHT & A MINIMUM OF 5.0 SQ. FT., FOR FIRST FLOOR EGRESS.
- T BASIC UNIT IS NOT AVAILABLE WITH TRI-PANE GLASS.
- ## NUMBER INDICATES DESIGN PRESSURE (DP) RATING WITH STANDARD GLASS.
- ##* NUMBER INDICATES HIGHER DP RATING, TALLER SILL STOP AND IMPACT GLAZING.

Note: Elevations shown DO NOT have exterior trim. Subtract 1/2"(12.7) from M.O.(Masonry Opening) for Unit Sizes. Masonry openings above include Sill Nose, see Trim Options page for Sill Nose specifications. For other Trim Options refer to the Unit Sizing, Rough Opening & Masonry Openings page.

SECTOR TOP UNITS
ELEVATIONS

MO BRICKMOLD
MO FLAT CASING
ROUGH OPENING
FRAME SIZE
DAYLIGHT OPENING

44 1/2"(1130)
47 9/16"(1208)
42"(1067)
41 1/4"(1048)
35 5/16"(897)

48 1/2"(1232)
51 9/16"(1310)
46"(1168)
45 1/4"(1149)
39 5/16"(999)

52 1/2"(1334)
55 9/16"(1411)
50"(1270)
49 1/4"(1251)
43 5/16"(1100)

74 27/32"(1901)
76 3/8"(1940)
73 3/16"(1849)
72 7/16"(1840)
51"(787)
31 5/32"(791)

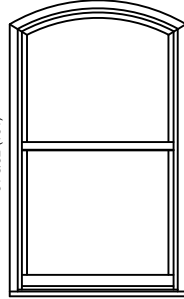

CWDR3632

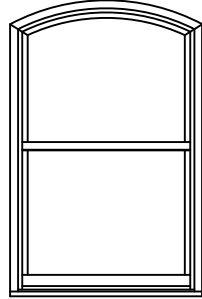

CWDR4032

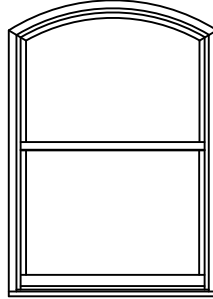

CWDR4432

80 27/32"(2007)
82 3/8"(2046)
80 3/16"(1949)
88 7/16"(2246)
39"(981)
39 5/32"(995)

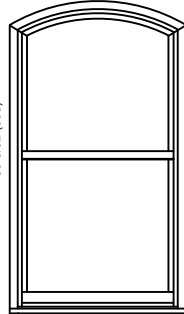

CWDR3634

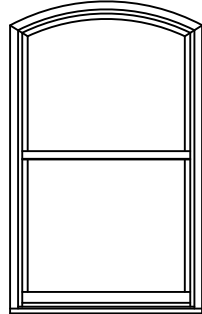

CWDR4034

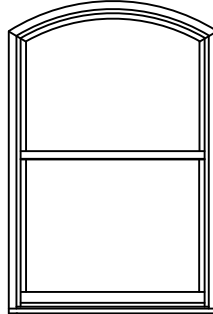

CWDR4434

82 27/32"(2104)
84 3/8"(2143)
81 3/16"(2045)
80 7/16"(2043)
35"(889)
35 5/32"(893)

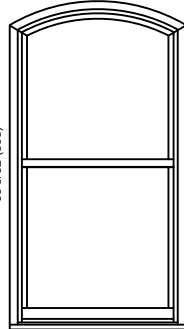

CWDR3636

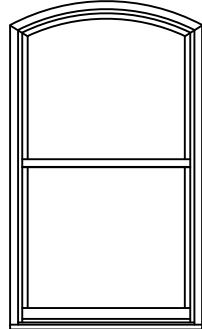

CWDR4036

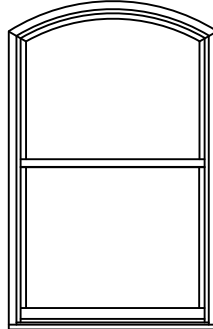

CWDR4436

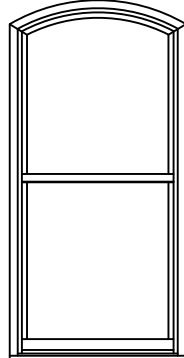

CWDR3640

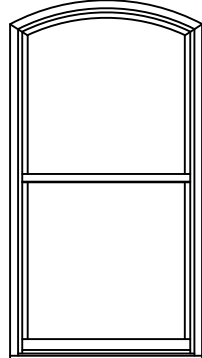

CWDR4040

ELEVATION SYMBOL LEGEND:

- M.O. = MASORNY OPENING
- VALUES IN () ARE IN MILLIMETER CONVERSIONS
- E UNIT MEETS EGRESS REQUIREMENT FOR IRC CODE. STATE AND LOCAL EGRESS CODES MAY DIFFER. ALWAYS REFER TO LOCAL BUILDING CODES FOR COMPLETE REQUIREMENTS. CHECK WITH LOCAL OFFICIALS TO ENSURE COMPLIANCE BEFORE INSTALLING THE UNIT.
- E1: BASIC UNIT CLEAR OPENING EXCEEDS 20" IN WIDTH, 24" IN HEIGHT & A MINIMUM OF 5.0 SQ. FT., FOR FIRST FLOOR EGRESS.
- T: BASIC UNIT IS NOT AVAILABLE WITH TRI-PANE GLASS.
- ## NUMBER INDICATES DESIGN PRESSURE (DP) RATING WITH STANDARD GLASS.
- ### NUMBER INDICATES HIGHER DP RATING, TALLER SILL STOP AND IMPACT GLAZING.

Note: Elevations shown DO NOT have exterior trim. Subtract 1/2"(12.7) from M.O.(Masonry Opening) for Unit Sizes. Masonry openings above include Sill Nose, see Trim Options page for Sill Nose specifications. For other Trim Options refer to the Unit Sizing, Rough Opening & Masonry Openings page.

SECTOR TOP COTTAGE UNITS
ELEVATIONS

MO BRICKMOLD	24 1/2"(622)	28 1/2"(724)	32 1/2"(826)	34 1/2"(876)	36 1/2"(927)	38 1/2"(978)	40 1/2"(1029)
MO FLAT CASING	27 9/16"(700)	31 9/16"(802)	35 9/16"(903)	37 9/16"(954)	39 9/16"(1005)	41 9/16"(1056)	43 9/16"(1106)
ROUGH OPENING	22"(589)	26"(660)	30"(762)	32"(813)	34"(864)	36"(914)	38"(965)
FRAME SIZE	21 1/4"(540)	25 1/4"(641)	29 1/4"(743)	31 1/4"(794)	33 1/4"(845)	35 1/4"(895)	37 1/4"(946)
DAYLIGHT OPENING	15 5/16"(389)	19 5/16"(491)	23 5/16"(592)	25 5/16"(643)	27 5/16"(694)	29 5/16"(744)	31 5/16"(795)

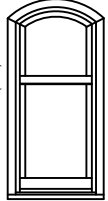
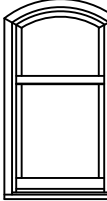
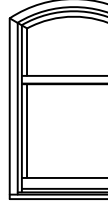
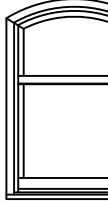
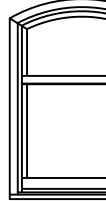
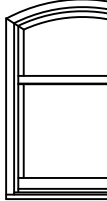
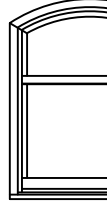
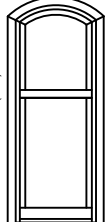
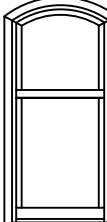
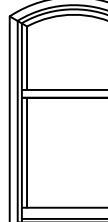
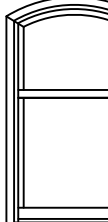
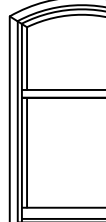
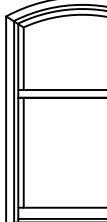
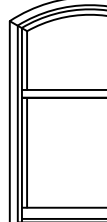
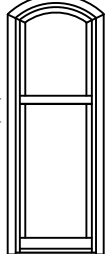
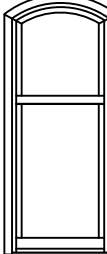
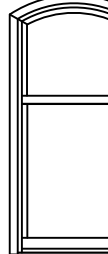
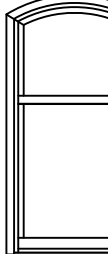
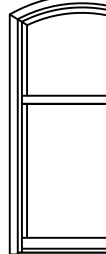
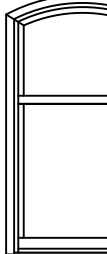
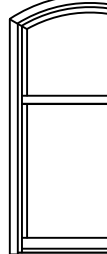
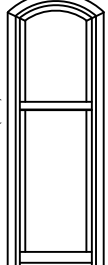
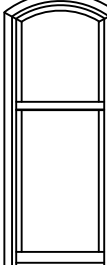
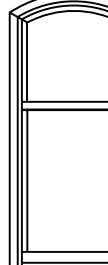
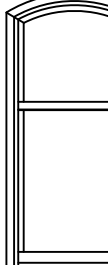
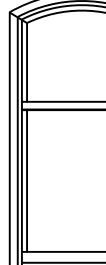
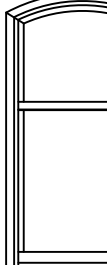
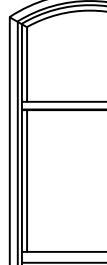
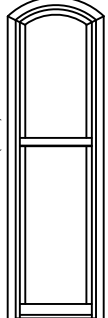
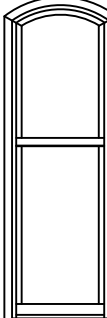
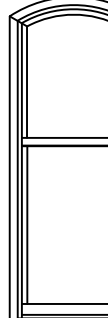
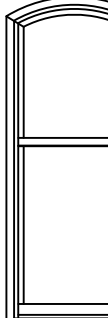
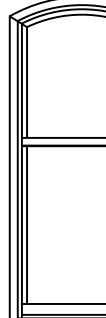
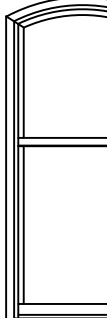
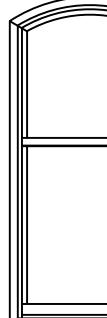
50 27/32" (1291) 52 3/8" (1330) 48 3/16" (1240) 44 3/4" (1125) 23 7/16" (585)							
	CWDR1616/24	CWDR2016/24	CWDR216/216/24	CWDR2616/24	CWDR2816/24	CWDR3016/24	CWDR3216/24
58 27/32" (1495) 60 3/8" (1534) 57 3/16" (1445) 53 3/4" (1330) 27 7/16" (687)							
	CWDR1620/28	CWDR2020/28	CWDR2420/28	CWDR2620/28	CWDR2820/28	CWDR3020/28	CWDR3220/28
66 27/32" (1699) 68 3/8" (1737) 65 3/16" (1648) 61 3/4" (1533) 33 7/16" (849)							
	CWDR1622/34	CWDR2022/34	CWDR2422/34	CWDR2622/34	CWDR2822/34	CWDR3022/34	CWDR3222/34
70 27/32" (1799) 72 3/8" (1838) 69 3/16" (1749) 65 3/4" (1634) 35 7/16" (900)							
	CWDR1624/36	CWDR2024/36	CWDR2424/36	CWDR2624/36	CWDR2824/36	CWDR3024/36	CWDR3224/36
82 27/32" (2104) 84 3/8" (2143) 81 3/16" (2054) 77 3/4" (1939) 39 7/16" (1002)							
	CWDR1632/40	CWDR2032/40	CWDR2432/40	CWDR2632/40	CWDR2832/40	CWDR3032/40	CWDR3232/40

ELEVATION SYMBOL LEGEND:
M.O. = MASONRY OPENING
VALUES IN () ARE IN MILLIMETER CONVERSIONS
E: UNIT MEETS EGRESS REQUIREMENT FOR IRC CODE. STATE AND LOCAL EGRESS CODES MAY DIFFER. ALWAYS REFER TO LOCAL BUILDING CODES FOR COMPLETE REQUIREMENTS. CHECK WITH LOCAL OFFICIALS TO ENSURE COMPLIANCE BEFORE INSTALLING THE UNIT.
E1: BASIC UNIT CLEAR OPENING EXCEEDS 20" IN WIDTH, 24" IN HEIGHT & A MINIMUM OF 5.0 SQ. FT., FOR FIRST FLOOR EGRESS.
T: BASIC UNIT IS NOT AVAILABLE WITH TRI-PANE GLASS.
##: NUMBER INDICATES DESIGN PRESSURE (DP) RATING WITH STANDARD GLASS.
###: NUMBER INDICATES HIGHER DP RATING, TALLER SILL STOP AND IMPACT GLAZING.
Note: Elevations shown DO NOT have exterior trim. Subtract 1/2"(12.7) from M.O.(Masonry Opening) for Unit Sizing. Masonry openings above include Sill Nose, see Trim Options page for Sill Nose specifications. For other Trim Options refer to the Unit Sizing, Rough Opening & Masonry Openings page.

SECTOR TOP COTTAGE UNITS
ELEVATIONS

44 1/2"(1130)
47 9/16"(1208)
42"(1067)
41 1/4"(1048)
35 5/16"(897)

48 1/2"(1232)
51 9/16"(1310)
46"(1168)
45 1/4"(1149)
39 5/16"(999)

52 1/2"(1334)
55 9/16"(1411)
50"(1270)
49 1/4"(1251)
43 5/16"(1100)

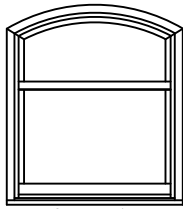

CWDR3616/24

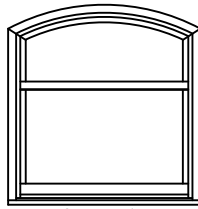

CWDR4016/24

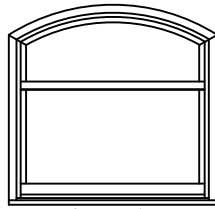

CWDR4416/24

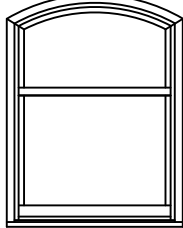

CWDR3620/28

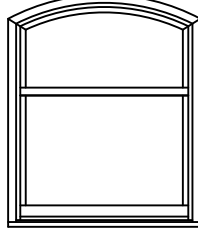

CWDR4020/28

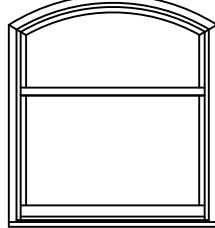

CWDR4420/28

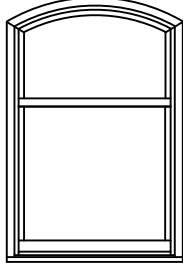

CWDR3622/34

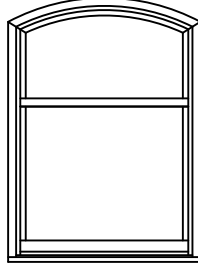

CWDR4022/34

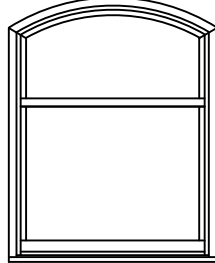

CWDR4422/34

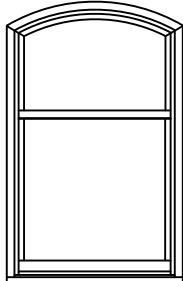

CWDR3624/36

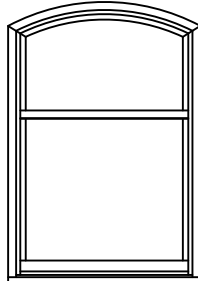

CWDR4024/36

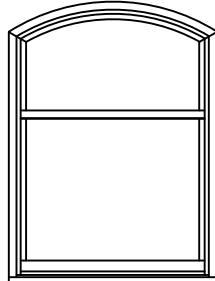

CWDR4424/36

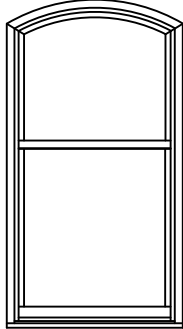

CWDR3632/40

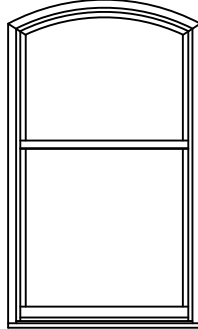









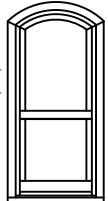
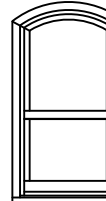
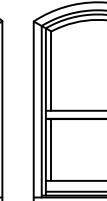
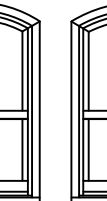
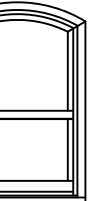
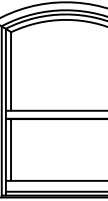
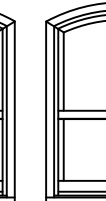
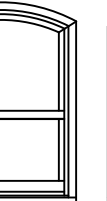
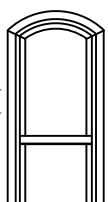
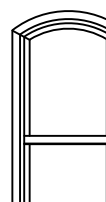
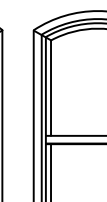
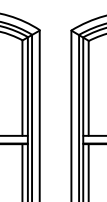
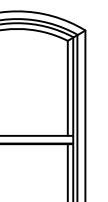
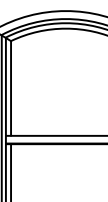
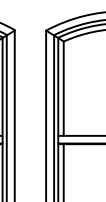

CWDR4032/40

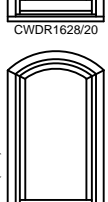
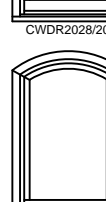
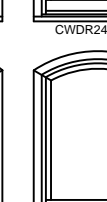
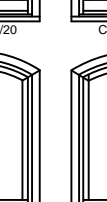
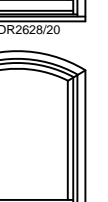
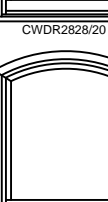
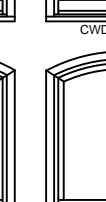
ELEVATION SYMBOL LEGEND:

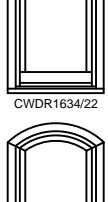
M.O. = MASORNY OPENING
 VALUES IN () ARE IN MILLIMETER CONVERSIONS
 E UNIT MEETS EGRESS REQUIREMENT FOR IRC CODE. STATE AND LOCAL EGRESS CODES MAY DIFFER. ALWAYS REFER TO LOCAL BUILDING CODES FOR COMPLETE REQUIREMENTS. CHECK WITH LOCAL OFFICIALS TO ENSURE COMPLIANCE BEFORE INSTALLING THE UNIT.
 E1: BASIC UNIT CLEAR OPENING EXCEEDS 20" IN WIDTH, 24" IN HEIGHT & A MINIMUM OF 5.0 SQ. FT., FOR FIRST FLOOR EGRESS.
 T BASIC UNIT IS NOT AVAILABLE WITH TRI-PANE GLASS.
 ## NUMBER INDICATES DESIGN PRESSURE (DP) RATING WITH STANDARD GLASS.
 ### NUMBER INDICATES HIGHER DP RATING, TALLER SILL STOP AND IMPACT GLAZING.
 Note: Elevations shown DO NOT have exterior trim. Subtract 1/2"(12.7) from M.O.(Masonry Opening) for Unit Sizes. Masonry openings above include Sill Nose, see Trim Options page for Sill Nose specifications. For other Trim Options refer to the Unit Sizing, Rough Opening & Masonry Openings page.

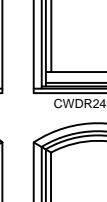
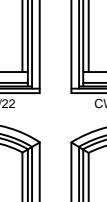
SECTOR TOP REVERSE COTTAGE UNITS
ELEVATIONS

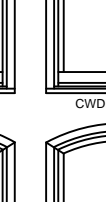
MO BRICKMOLD	24 1/2"(622)	28 1/2"(724)	32 1/2"(826)	34 1/2"(876)	36 1/2"(927)	38 1/2"(978)	40 1/2"(1029)
MO FLAT CASING	27 9/16"(700)	31 9/16"(802)	35 9/16"(903)	37 9/16"(954)	39 9/16"(1005)	41 9/16"(1056)	43 9/16"(1106)
ROUGH OPENING	22"(589)	26"(660)	30"(762)	32"(813)	34"(864)	36"(914)	38"(965)
FRAME SIZE	21 1/4"(540)	25 1/4"(641)	29 1/4"(743)	31 1/4"(794)	33 1/4"(845)	35 1/4"(895)	37 1/4"(946)
DAYLIGHT OPENING	15 5/16"(389)	19 5/16"(491)	23 5/16"(592)	25 5/16"(643)	27 5/16"(694)	29 5/16"(744)	31 5/16"(795)

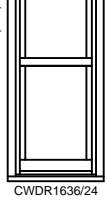
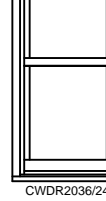
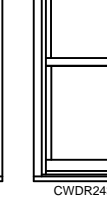
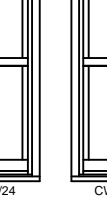
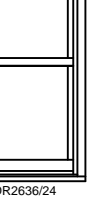
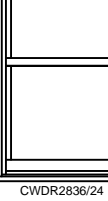
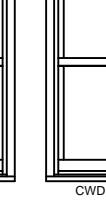
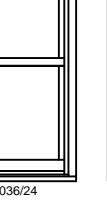
50 27/32"(1291) 52 3/8"(1330) 49 3/16"(1240) 48 1/2"(1230) 47 3/4"(1220) 15 7/16"(392)								
	CWDR1624/16	CWDR2024/16	CWDR2424/16	CWDR2624/16	CWDR2824/16	CWDR3024/16	CWDR3224/16	CWDR3224/16
58 27/32"(1495) 60 3/8"(1533) 57 3/16"(1443) 56 1/2"(1433) 55 3/4"(1423) 19 7/16"(494)								
	CWDR1628/20	CWDR2028/20	CWDR2428/20	CWDR2628/20	CWDR2828/20	CWDR3028/20	CWDR3228/20	CWDR3228/20
66 27/32"(1699) 68 3/8"(1737) 65 3/16"(1647) 64 1/2"(1637) 63 3/4"(1627) 21 7/16"(545)								
	CWDR1634/22	CWDR2034/22	CWDR2434/22	CWDR2634/22	CWDR2834/22	CWDR3034/22	CWDR3234/22	CWDR3234/22
70 27/32"(1799) 72 3/8"(1836) 69 3/16"(1746) 68 1/2"(1736) 67 3/4"(1726) 23 7/16"(595)								
	CWDR1636/24	CWDR2036/24	CWDR2436/24	CWDR2636/24	CWDR2836/24	CWDR3036/24	CWDR3236/24	CWDR3236/24
82 27/32"(2104) 84 3/8"(2143) 81 3/16"(2053) 80 1/2"(2043) 79 3/4"(2033) 31 7/16"(799)								
	CWDR1640/32	CWDR2040/32	CWDR2440/32	CWDR2640/32	CWDR2840/32	CWDR3040/32	CWDR3240/32	CWDR3240/32

ELEVATION SYMBOL LEGEND:
M.O. = MASORNY OPENING
VALUES IN () ARE IN MILLIMETER CONVERSIONS
E UNIT MEETS EGRESS REQUIREMENT FOR IRC CODE. STATE AND LOCAL EGRESS CODES MAY DIFFER. ALWAYS REFER TO LOCAL BUILDING CODES FOR COMPLETE REQUIREMENTS. CHECK WITH LOCAL OFFICIALS TO ENSURE COMPLIANCE BEFORE INSTALLING THE UNIT.
E1 BASIC UNIT CLEAR OPENING EXCEEDS 20" IN WIDTH, 24" IN HEIGHT & A MINIMUM OF 5.0 SQ. FT., FOR FIRST FLOOR EGRESS.
T BASIC UNIT IS NOT AVAILABLE WITH TRI-PANE GLASS.
NUMBER INDICATES DESIGN PRESSURE (DP) RATING WITH STANDARD GLASS.
NUMBER INDICATES HIGHER DP RATING, TALLER SILL, STOP AND IMPACT GLAZING.
Note: Elevations shown DO NOT have exterior trim. Subtract 1/2"(12.7) from M.O.(Masonry Opening) for Unit Sizes. Masonry openings above include Sill Nose, see Trim Options page for Sill Nose specifications. For other Trim Options refer to the Unit Sizing, Rough Opening & Masonry Openings page.

SECTOR TOP REVERSE COTTAGE UNITS
ELEVATIONS

	44 1/2"(1130) 47 9/16"(1208) 42"(1067) 41 1/4"(1048) 35 5/16"(897)	48 1/2"(1232) 51 9/16"(1310) 46"(1168) 45 1/4"(1149) 39 5/16"(999)	52 1/2"(1334) 55 9/16"(1411) 50"(1270) 49 1/4"(1251) 43 5/16"(1100)
50 7/32"(1291) 52 3/8"(1320) 49 3/16"(1240) 48 7/16"(1230) 22 3/4"(578) 15 7/16"(392)			
	CWD3624/16	CWD4024/16	CWD4424/16
58 7/32"(1405) 60 3/8"(1533) 57 3/16"(1645) 56 7/16"(1434) 26 3/4"(679) 19 7/16"(494)			
	CWD3628/20	CWD4028/20	CWD4428/20
66 7/32"(1689) 68 3/8"(1737) 65 3/16"(1649) 64 7/16"(1637) 32 3/4"(832) 21 7/16"(545)			
	CWD3634/22	CWD4034/22	CWD4434/22
70 7/32"(1799) 72 3/8"(1838) 69 3/16"(1740) 68 7/16"(1738) 34 3/4"(883) 23 7/16"(595)			
	CWD3636/24	CWD4036/24	CWD4436/24
82 7/32"(2104) 84 3/8"(2143) 81 3/16"(2045) 80 7/16"(2043) 38 3/4"(984) 31 7/16"(799)			
	CWD3640/32	CWD4040/32	

ELEVATION SYMBOL LEGEND:

M.O. = MASORNY OPENING
 VALUES IN () ARE IN MILLIMETER CONVERSIONS
 E: UNIT MEETS EGRESS REQUIREMENT FOR IRC CODE. STATE AND LOCAL EGRESS CODES MAY DIFFER. ALWAYS REFER TO LOCAL BUILDING CODES FOR COMPLETE REQUIREMENTS. CHECK WITH LOCAL OFFICIALS TO ENSURE COMPLIANCE BEFORE INSTALLING THE UNIT.
 E1: BASIC UNIT CLEAR OPENING EXCEEDS 20" IN WIDTH, 24" IN HEIGHT & A MINIMUM OF 5.0 SQ. FT., FOR FIRST FLOOR EGRESS.
 T: BASIC UNIT IS NOT AVAILABLE WITH TRI-PANE GLASS.
 ## NUMBER INDICATES DESIGN PRESSURE (DP) RATING WITH STANDARD GLASS.
 ##+ NUMBER INDICATES HIGHER DP RATING, TALLER SILL STOP AND IMPACT GLAZING.
 Note: Elevations shown DO NOT have exterior trim. Subtract 1/2"(12.7) from M.O.(Masonry Opening) for Unit Sizes. Masonry openings above include Sill Nose, see Trim Options page for Sill Nose specifications. For other Trim Options refer to the Unit Sizing, Rough Opening & Masonry Openings page.

COTTAGE SINGLE UNITS
ELEVATIONS

MO BRICKMOLD
MO FLAT CASING
ROUGH OPENING
FRAME SIZE
DAYLIGHT OPENING

24 5/8"(625)
27 11/16"(703)
22 1/8"(562)
21 3/8"(543)
15 7/16"(392)

28 5/8"(727)
31 11/16"(805)
26 1/8"(664)
25 3/8"(645)
19 7/16"(494)

32 5/8"(829)
35 11/16"(906)
30 1/8"(765)
29 3/8"(746)
23 7/16"(595)

34 5/8"(879)
37 11/16"(957)
32 1/8"(816)
31 3/8"(797)
25 7/16"(646)

36 5/8"(930)
39 11/16"(1008)
34 1/8"(867)
33 3/8"(848)
27 7/16"(697)

38 5/8"(981)
41 11/16"(1059)
36 1/8"(918)
35 3/8"(899)
29 7/16"(740)

40 5/8"(1032)
43 11/16"(1110)
38 1/8"(968)
37 3/8"(949)
31 7/16"(799)

50 13/32"(1280)
51 15/16"(1319)
48 3/4"(1238)
48 1/2"(1219)
14 13/16"(376)
23 7/16"(605)

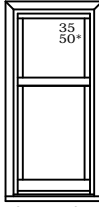

CWD2148C24

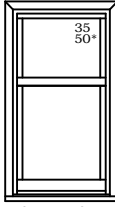

CWD2548C24

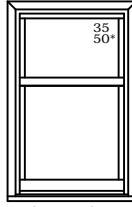

CWD2948C24

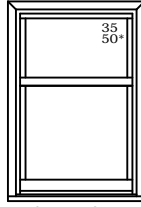

CWD3148C24

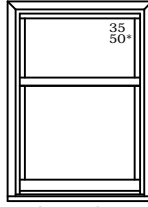

CWD3348C24

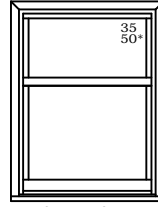

CWD3548C24

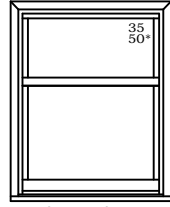

CWD3748C24

56 13/32"(1484)
59 15/16"(1522)
56 3/4"(1441)
56 1/2"(1422)
18 13/16"(478)
27 7/16"(697)

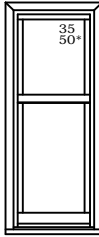

CWD2156C28

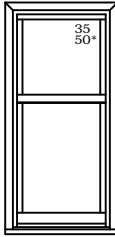

CWD2556C28

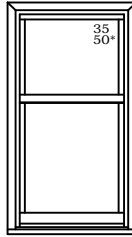

CWD2956C28

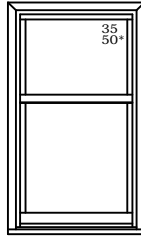

CWD3156C28

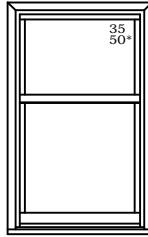

CWD3356C28

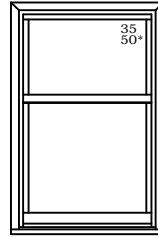

CWD3556C28

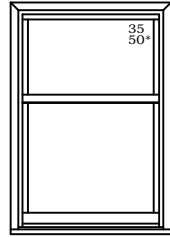

CWD3756C28

66 13/32"(1687)
67 15/16"(1726)
64 3/4"(1645)
64 1/2"(1626)
20 13/16"(529)
33 7/16"(849)

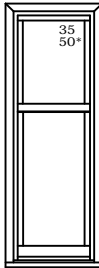

CWD2164C34

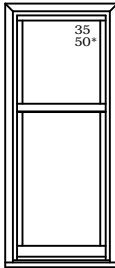

CWD2564C34

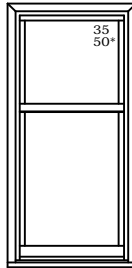

CWD2964C34

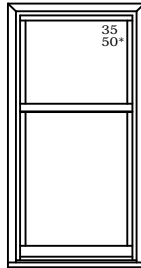

CWD3164C34

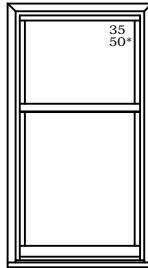

CWD3364C34

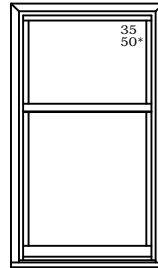

CWD3564C34

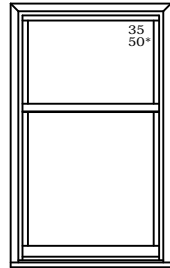

CWD3764C34

70 13/32"(1788)
71 15/16"(1827)
68 3/4"(1746)
68 1/2"(1727)
22 13/16"(579)
35 7/16"(900)

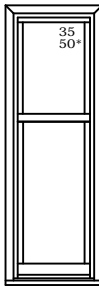

CWD2168C36

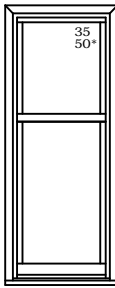

CWD2568C36

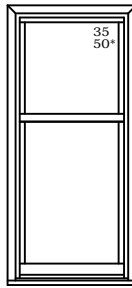

CWD2968C36

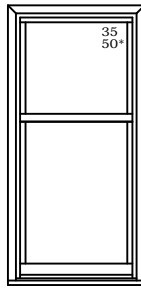

CWD3168C36

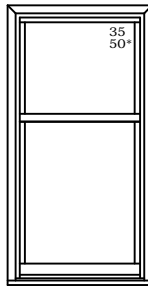

CWD3368C36

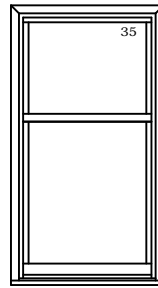

CWD3568C36

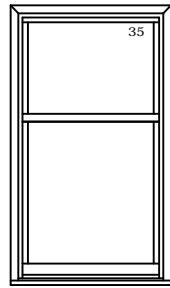

CWD3768C36

82 13/32"(2093)
83 15/16"(2132)
80 3/4"(2051)
80 1/2"(2032)
30 13/16"(783)
39 7/16"(1002)

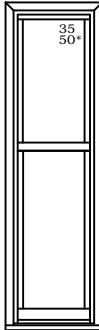

CWD2180C40

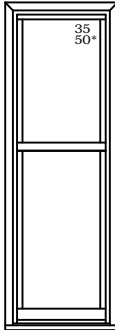

CWD2580C40

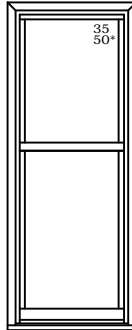

CWD2980C40

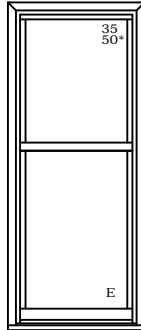

CWD3180C40

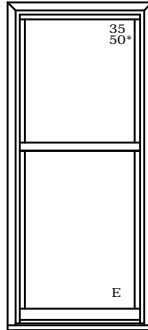

CWD3380C40

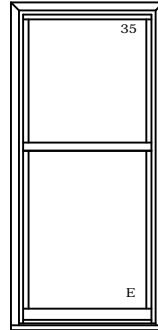

CWD3580C40

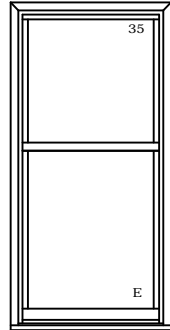

CWD3780C40

ELEVATION SYMBOL LEGEND:

M.O. = MASORNY OPENING
VALUES IN () ARE IN MILLIMETER CONVERSIONS
E UNIT MEETS EGRESS REQUIREMENT FOR IRC CODE. STATE AND LOCAL EGRESS CODES MAY DIFFER. ALWAYS REFER TO LOCAL BUILDING CODES FOR COMPLETE REQUIREMENTS. CHECK WITH LOCAL OFFICIALS TO ENSURE COMPLIANCE BEFORE INSTALLING THE UNIT.
E1 BASIC UNIT CLEAR OPENING EXCEEDS 20" IN WIDTH, 24" IN HEIGHT & A MINIMUM OF 5.0 SQ. FT., FOR FIRST FLOOR EGRESS.
T BASIC UNIT IS NOT AVAILABLE WITH TRI-PANE GLASS.
NUMBER INDICATES DESIGN PRESSURE (DP) RATING WITH STANDARD GLASS.
NUMBER INDICATES HIGHER DP RATING, TALLER SILL STOP AND IMPACT GLAZING.
Note: Elevations shown DO NOT have exterior trim. Subtract 1/2"(12.7) from M.O.(Masonry Opening) for Unit Sizes. Masonry openings above include Sill Nose, see Trim Options page for Sill Nose specifications. For other Trim Options refer to the Unit Sizing, Rough Opening & Masonry Openings page.

COTTAGE SINGLE UNITS
ELEVATIONS

MO BRICKMOLD
MO FLAT CASING
ROUGH OPENING
FRAME SIZE
DAYLIGHT OPENING

44 5/8"(1133)
47 11/16"(1211)
42 1/8"(1070)
41 3/8"(1051)
35 7/16"(900)

48 5/8"(1235)
51 11/16"(1313)
46 1/8"(1172)
45 3/8"(1153)
39 7/16"(1002)

50 13/32"(1280)
51 15/16"(1319)
48 3/4"(1238)
48"(1219)
14 13/16"(376)
23 7/16"(595)

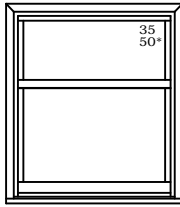

CWD4148C24

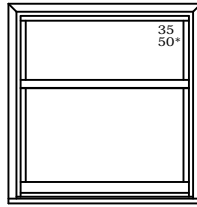

CWD4548C24

58 13/32"(1484)
59 15/16"(1522)
56 3/4"(1441)
56"(1422)
18 13/16"(478)
27 7/16"(697)

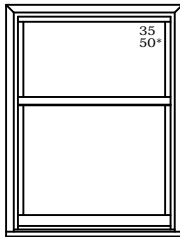

CWD4156C28

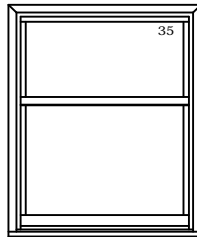

CWD4556C28

66 13/32"(1687)
67 15/16"(1726)
64 3/4"(1645)
64"(1626)
20 13/16"(529)
33 7/16"(849)

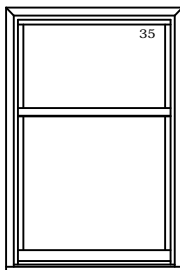

CWD4164C34

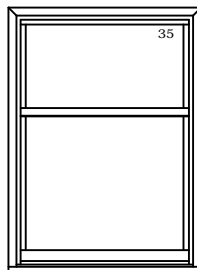

CWD4564C34

70 13/32"(1788)
71 15/16"(1827)
68 3/4"(1746)
68"(1727)
22 13/16"(579)
35 7/16"(900)

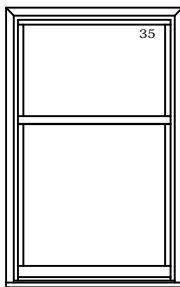

CWD4168C36

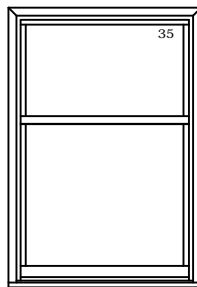

CWD4568C36

ELEVATION SYMBOL LEGEND:

- M.O. = MASORNY OPENING
- VALUES IN () ARE IN MILLIMETER CONVERSIONS
- E UNIT MEETS EGRESS REQUIREMENT FOR IRC CODE. STATE AND LOCAL EGRESS CODES MAY DIFFER. ALWAYS REFER TO LOCAL BUILDING CODES FOR COMPLETE REQUIREMENTS. CHECK WITH LOCAL OFFICIALS TO ENSURE COMPLIANCE BEFORE INSTALLING THE UNIT.
- E| BASIC UNIT CLEAR OPENING EXCEEDS 20" IN WIDTH, 24" IN HEIGHT & A MINIMUM OF 5.0 SQ. FT., FOR FIRST FLOOR EGRESS.
- T BASIC UNIT IS NOT AVAILABLE WITH TRI-PANE GLASS.
- ## NUMBER INDICATES DESIGN PRESSURE (DP) RATING WITH STANDARD GLASS.
- ### NUMBER INDICATES HIGHER DP RATING, TALLER SILL STOP AND IMPACT GLAZING.

Note: Elevations shown DO NOT have exterior trim. Subtract 1/2"(12.7) from M.O.(Masonry Opening) for Unit Sizes. Masonry openings above include Sill Nose, see Trim Options page for Sill Nose specifications. For other Trim Options refer to the Unit Sizing, Rough Opening & Masonry Openings page.

COTTAGE 2 WIDE UNITS
ELEVATIONS

	46"(1168)	54"(1372)	62"(1575)	66"(1676)	70"(1778)	74"(1880)	78"(1981)
MO BRICKMOLD	49 1/16"(1246)	57 1/16"(1449)	64 1/16"(1627)	68 1/16"(1729)	72 1/16"(1830)	76 1/16"(1932)	80 1/16"(2034)
MO FLAT CASING	43 1/2"(1105)	51 1/2"(1283)	59 1/2"(1511)	63 1/2"(1613)	67 1/2"(1715)	71 1/2"(1816)	75 1/2"(1918)
ROUGH OPENING	42 3/4"(1086)	50 3/4"(1289)	58 3/4"(1492)	62 3/4"(1594)	66 3/4"(1695)	70 3/4"(1797)	74 3/4"(1899)
FRAME SIZE	15 7/16"[2](392)[2]	19 7/16"[2](494)[2]	23 7/16"[2](595)[2]	25 7/16"[2](646)[2]	27 7/16"[2](697)[2]	29 7/16"[2](740)[2]	31 7/16"[2](799)[2]
DAYLIGHT OPENING							
	50 13/32"(1280) 51 15/16"(1319) 48 3/4"(1238) 48"(1219) 14 13/16"(376) 23 7/16"(595)						
	CWD2148C24-2	CWD2548C24-2	CWD2948C24-2	CWD3148C24-2	CWD3348C24-2	CWD3548C24-2	CWD3748C24-2
	58 13/32"(1484) 59 15/16"(1522) 56 3/4"(1441) 56"(1422) 18 13/16"(478) 27 7/16"(697)						
	CWD2156C28-2	CWD2556C28-2	CWD2956C28-2	CWD3156C28-2	CWD3356C28-2	CWD3556C28-2	CWD3756C28-2
	66 13/32"(1687) 67 15/16"(1726) 64 3/4"(1645) 64"(1626) 20 13/16"(529) 33 7/16"(849)						
	CWD2164C34-2	CWD2564C34-2	CWD2964C34-2	CWD3164C34-2	CWD3364C34-2	CWD3564C34-2	CWD3764C34-2
	70 13/32"(1789) 71 15/16"(1827) 68 3/4"(1746) 68"(1727) 22 13/16"(579) 35 7/16"(900)						
	CWD2168C36-2	CWD2568C36-2	CWD2968C36-2	CWD3168C36-2	CWD3368C36-2	CWD3568C36-2	CWD3768C36-2
	82 13/32"(2093) 83 15/16"(2132) 80 3/4"(2051) 80"(2032) 30 13/16"(783) 39 7/16"(1002)						
	CWD2180C40-2	CWD2580C40-2	CWD2980C40-2	CWD3180C40-2	CWD3380C40-2	CWD3580C40-2	CWD3780C40-2



ELEVATION SYMBOL LEGEND:

- M.O. = MASORNY OPENING
- VALUES IN () ARE IN MILLIMETER CONVERSIONS
- VALUES IN [] ARE NUMBER OF DAYLIGHT OPENINGS PER UNIT
- E UNIT MEETS EGRESS REQUIREMENT FOR IRC CODE. STATE AND LOCAL EGRESS CODES MAY DIFFER. ALWAYS REFER TO LOCAL BUILDING CODES FOR COMPLETE REQUIREMENTS. CHECK WITH LOCAL OFFICIALS TO ENSURE COMPLIANCE BEFORE INSTALLING THE UNIT.
- E1 BASIC UNIT CLEAR OPENING EXCEEDS 20" IN WIDTH, 24" IN HEIGHT & A MINIMUM OF 5.0 SQ. FT., FOR FIRST FLOOR EGRESS.
- T BASIC UNIT IS NOT AVAILABLE WITH TRI-PANE GLASS.
- ## NUMBER INDICATES DESIGN PRESSURE (DP) RATING WITH STANDARD GLASS.
- ### NUMBER INDICATES HIGHER DP RATING, TALLER SILL STOP AND IMPACT GLAZING.

Note: Elevations shown DO NOT have exterior trim. Subtract 1/2"(12.7) from M.O.(Masonry Opening) for Unit Sizes. Masonry openings above include Sill Nose, see Trim Options page for Sill Nose specifications. For other Trim Options refer to the Unit Sizing, Rough Opening & Masonry Openings page.

COTTAGE 2 WIDE UNITS
ELEVATIONS

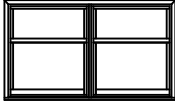
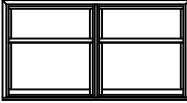
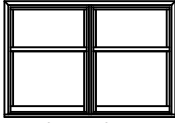
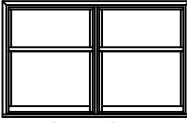
MO BRICKMOLD	86"(2184)	94"(2388)
MO FLAT CASING	88 1/16"(2237)	96 1/16"(2440)
ROUGH OPENING	83 1/2"(2121)	91 1/2"(2324)
FRAME SIZE	82 3/4"(2102)	90 3/4"(2305)
DAYLIGHT OPENING	35 7/16"[2](900)[2]	39 7/16"[2](1002)[2]

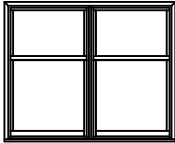
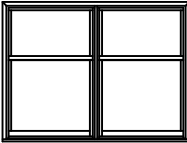
50 13/32"(1280)		
51 15/16"(1319)	CWD4148C24-2	CWD4548C24-2
48 3/4"(1238)		
48 1/2"(1219)		
14 13/16"(376)		
23 7/16"(595)		
58 13/32"(1484)		
59 15/16"(1522)	CWD4156C28-2	CWD4556C28-2
56 3/4"(1441)		
56 1/2"(1422)		
18 13/16"(478)		
27 7/16"(697)		
66 13/32"(1687)		
67 15/16"(1726)	CWD4164C34-2	CWD4564C34-2
64 3/4"(1645)		
64 1/2"(1626)		
20 13/16"(529)		
33 7/16"(849)		
70 13/32"(1788)		
71 15/16"(1827)	CWD4168C36-2	CWD4568C36-2
68 3/4"(1746)		
68 1/2"(1727)		
22 13/16"(579)		
35 7/16"(900)		

ELEVATION SYMBOL LEGEND:

- M.O. = MASORNY OPENING
- VALUES IN () ARE IN MILLIMETER CONVERSIONS
- VALUES IN [] ARE NUMBER OF DAYLIGHT OPENINGS PER UNIT
- E UNIT MEETS EGRESS REQUIREMENT FOR IRC CODE. STATE AND LOCAL EGRESS CODES MAY DIFFER. ALWAYS REFER TO LOCAL BUILDING CODES FOR COMPLETE REQUIREMENTS. CHECK WITH LOCAL OFFICIALS TO ENSURE COMPLIANCE BEFORE INSTALLING THE UNIT.
- E1 BASIC UNIT CLEAR OPENING EXCEEDS 20" IN WIDTH, 24" IN HEIGHT & A MINIMUM OF 5.0 SQ. FT., FOR FIRST FLOOR EGRESS.
- T BASIC UNIT IS NOT AVAILABLE WITH TRI-PANE GLASS.
- ## NUMBER INDICATES DESIGN PRESSURE (DP) RATING WITH STANDARD GLASS.
- ##* NUMBER INDICATES HIGHER DP RATING, TALLER SILL STOP AND IMPACT GLAZING.

Note: Elevations shown DO NOT have exterior trim. Subtract 1/2"(12.7) from M.O.(Masonry Opening) for Unit Sizes. Masonry openings above include Sill Nose, see Trim Options page for Sill Nose specifications. For other Trim Options refer to the Unit Sizing, Rough Opening & Masonry Openings page.

COTTAGE 3 WIDE UNITS
ELEVATIONS

MO BRICKMOLD
MO FLAT CASING
ROUGH OPENING
FRAME SIZE
DAYLIGHT OPENING

67 3/8"(1711)
70 7/16"(1789)
64 7/8"(1648)
64 1/8"(1629)
15 7/16"[3](392)[3]

79 3/8"(2016)
82 7/16"(2094)
76 7/8"(1946)
76 1/8"(1934)
19 7/16"[3](494)[3]

91 3/8"(2321)
94 7/16"(2399)
88 7/8"(2257)
88 1/8"(2238)
23 7/16"[3](595)[3]

97 3/8"(2473)
100 7/16"(2551)
94 7/8"(2410)
94 1/8"(2391)
25 7/16"[3](646)[3]

103 3/8"(2626)
106 7/16"(2704)
100 7/8"(2556)
100 1/8"(2543)
27 7/16"[3](697)[3]

50 13/32"(1280)
51 15/16"(1318)
48 3/4"(1238)
48"(1219)
14 13/16"(376)
23 7/16"(595)



CWD2148C24-3



CWD2548C24-3

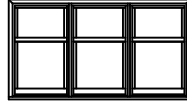

CWD2948C24-3

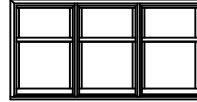

CWD3148C24-3



CWD3348C24-3

58 13/32"(1484)
59 15/16"(1522)
56 3/4"(1441)
56"(1422)
18 13/16"(478)
27 7/16"(697)

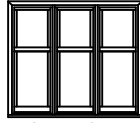

CWD2156C28-3

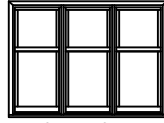

CWD2556C28-3

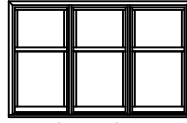

CWD2956C28-3

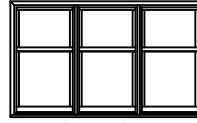

CWD3156C28-3

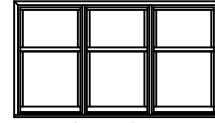

CWD3356C28-3

66 13/32"(1687)
67 15/16"(1726)
64 3/4"(1645)
64"(1626)
20 13/16"(529)
33 7/16"(849)

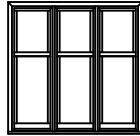

CWD2164C34-3

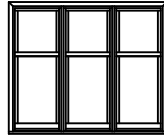

CWD2564C34-3

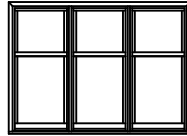

CWD2964C34-3

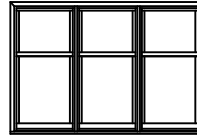

CWD3164C34-3

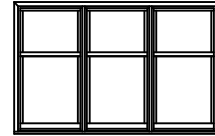

CWD3364C34-3

70 13/32"(1788)
71 15/16"(1827)
68 3/4"(1746)
68"(1727)
22 13/16"(579)
35 7/16"(900)

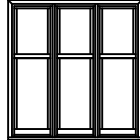

CWD2168C36-3

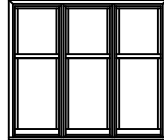

CWD2568C36-3

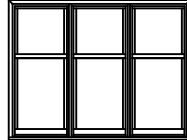

CWD2968C36-3

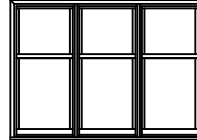

CWD3168C36-3

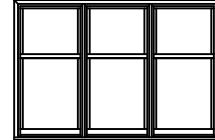

CWD3368C36-3

82 13/32"(2083)
83 15/16"(2132)
80 3/4"(2051)
80"(2032)
30 13/16"(783)
39 7/16"(1002)

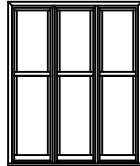

CWD2180C40-3

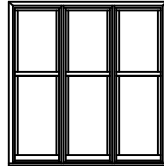

CWD2580C40-3

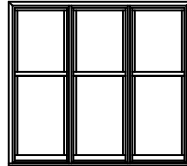

CWD2980C40-3

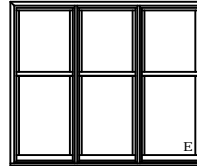

CWD3180C40-3

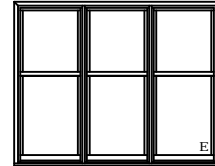

CWD3380C40-3

ELEVATION SYMBOL LEGEND:

- M.O. = MASORNY OPENING
- VALUES IN () ARE IN MILLIMETER CONVERSIONS
- VALUES IN [] ARE NUMBER OF DAYLIGHT OPENINGS PER UNIT
- E UNIT MEETS EGRESS REQUIREMENT FOR IRC CODE. STATE AND LOCAL EGRESS CODES MAY DIFFER. ALWAYS REFER TO LOCAL BUILDING CODES FOR COMPLETE REQUIREMENTS. CHECK WITH LOCAL OFFICIALS TO ENSURE COMPLIANCE BEFORE INSTALLING THE UNIT.
- E1 BASIC UNIT CLEAR OPENING EXCEEDS 20" IN WIDTH, 24" IN HEIGHT & A MINIMUM OF 5.0 SQ. FT., FOR FIRST FLOOR EGRESS.
- T BASIC UNIT IS NOT AVAILABLE WITH TRI-PANE GLASS.
- ## NUMBER INDICATES DESIGN PRESSURE (DP) RATING WITH STANDARD GLASS.
- ##* NUMBER INDICATES HIGHER DP RATING, TALLER SILL STOP AND IMPACT GLAZING.

Note: Elevations shown DO NOT have exterior trim. Subtract 1/2"(12.7) from M.O.(Masonry Opening) for Unit Sizes. Masonry openings above include Sill Nose, see Trim Options page for Sill Nose specifications. For other Trim Options refer to the Unit Sizing, Rough Opening & Masonry Openings page.

COTTAGE 3 WIDE UNITS
ELEVATIONS

MO BRICKMOLD
MO FLAT CASING
ROUGH OPENING
FRAME SIZE
DAYLIGHT OPENING

109 3/8"(2778)
112 7/16"(2856)
106 7/8"(2715)
106 1/8"(2696)
29 7/16"[3](748)[3]

115 3/8"(2931)
118 7/16"(3008)
112 7/8"(2867)
112 1/8"(2848)
31 7/16"[3](799)[3]

127 3/8"(3235)
130 7/16"(3313)
124 7/8"(3172)
124 1/8"(3153)
35 7/16"[3](900)[3]

139 3/8"(3540)
142 7/16"(3618)
136 7/8"(3477)
136 1/8"(3458)
39 7/16"[3](1002)[3]

50 13/32"(1280)
51 15/16"(1319)
48 3/4"(1238)
14 13/16"(376)
23 7/16"(595)

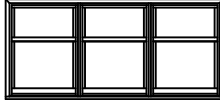

CWD3548C24-3

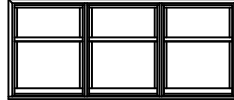

CWD3748C24-3

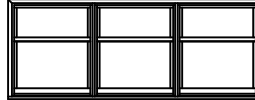

CWD4148C24-3

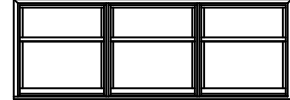

CWD4548C24-3

58 13/32"(1484)
59 15/16"(1522)
56 3/4"(1441)
56"(1422)
18 13/16"(478)
27 7/16"(697)

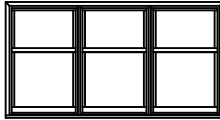

CWD3556C28-3

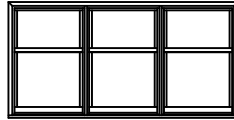

CWD3756C28-3

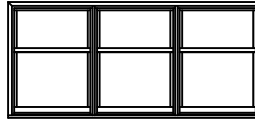

CWD4156C28-3

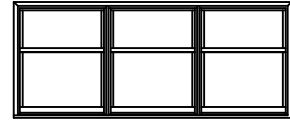

CWD4556C28-3

66 13/32"(1687)
67 15/16"(1726)
64 3/4"(1645)
64"(1626)
20 13/16"(529)
33 7/16"(849)

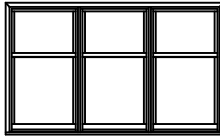

CWD3564C64-3

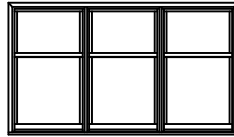

CWD3764C64-3

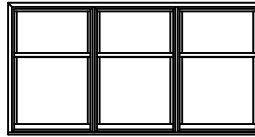

CWD4164C64-3

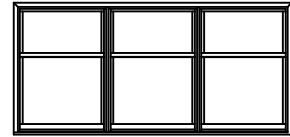

CWD4564C64-3

70 13/32"(1788)
71 15/16"(1827)
68 3/4"(1746)
68"(1727)
22 13/16"(579)
35 7/16"(900)

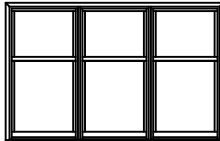

CWD3568C36-3

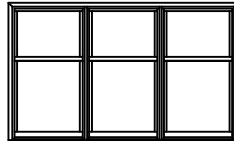

CWD3768C36-3

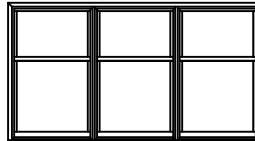

CWD4168C36-3

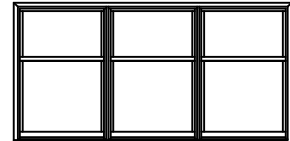

CWD4568C36-3

82 13/32"(2093)
83 15/16"(2132)
80 3/4"(2051)
80"(2032)
30 13/16"(783)
39 7/16"(1002)

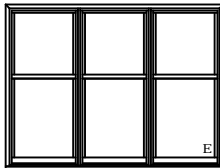

CWD3580C40-3

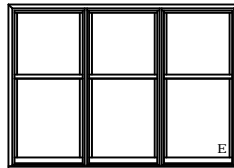

CWD3780C40-3

ELEVATION SYMBOL LEGEND:

- M.O. = MASORNY OPENING
- VALUES IN () ARE IN MILLIMETER CONVERSIONS
- VALUES IN [] ARE NUMBER OF DAYLIGHT OPENINGS PER UNIT
- E UNIT MEETS EGRESS REQUIREMENT FOR IRC CODE, STATE AND LOCAL EGRESS CODES MAY DIFFER. ALWAYS REFER TO LOCAL BUILDING CODES FOR COMPLETE REQUIREMENTS. CHECK WITH LOCAL OFFICIALS TO ENSURE COMPLIANCE BEFORE INSTALLING THE UNIT.
- E1 BASIC UNIT CLEAR OPENING EXCEEDS 20" IN WIDTH, 24" IN HEIGHT & A MINIMUM OF 5.0 SQ. FT., FOR FIRST FLOOR EGRESS.
- T BASIC UNIT IS NOT AVAILABLE WITH TRI-PANE GLASS.
- # NUMBER INDICATES DESIGN PRESSURE (DP) RATING WITH STANDARD GLASS.
- ## NUMBER INDICATES HIGHER DP RATING, TALLER SILL STOP AND IMPACT GLAZING.

Note: Elevations shown DO NOT have exterior trim. Subtract 1/2"(12.7) from M.O.(Masonry Opening) for Unit Sizes. Masonry openings above include Sill Nose, see Trim Options page for Sill Nose specifications. For other Trim Options refer to the Unit Sizing, Rough Opening & Masonry Openings page.

REVERSE COTTAGE SINGLE UNITS
ELEVATIONS

MO BRICKMOLD	24 5/8"(625)	28 5/8"(727)	32 5/8"(829)	34 5/8"(879)	36 5/8"(930)	38 5/8"(981)	40 5/8"(1032)
MO FLAT CASING	27 11/16"(703)	31 11/16"(805)	35 11/16"(906)	37 11/16"(957)	39 11/16"(1008)	41 11/16"(1059)	43 11/16"(1110)
ROUGH OPENING	22 1/8"(562)	26 1/8"(664)	30 1/8"(765)	32 1/8"(816)	34 1/8"(867)	36 1/8"(918)	38 1/8"(968)
FRAME SIZE	21 3/8"(543)	25 3/8"(645)	29 3/8"(746)	31 3/8"(797)	33 3/8"(848)	35 3/8"(899)	37 3/8"(949)
DAYLIGHT OPENING	15 7/16"(392)	19 7/16"(494)	23 7/16"(595)	25 7/16"(646)	27 7/16"(697)	29 7/16"(748)	31 7/16"(799)
50 13/32"(1280) 51 15/16"(1318) 48 3/4"(1236) 47 1/2"(1213) 22 13/16"(579) 15 7/16"(392)							
58 13/32"(1484) 59 15/16"(1522) 56 3/4"(1441) 55 1/2"(1418) 26 13/16"(681) 19 7/16"(494)							
66 13/32"(1687) 67 15/16"(1726) 64 3/4"(1645) 63 1/2"(1622) 30 13/16"(783) 21 7/16"(545)							
70 13/32"(1788) 71 15/16"(1827) 68 3/4"(1746) 67 1/2"(1723) 34 13/16"(884) 23 7/16"(595)							
82 13/32"(2093) 83 15/16"(2132) 80 3/4"(2051) 79 1/2"(2028) 38 13/16"(986) 31 7/16"(800)							

ELEVATION SYMBOL LEGEND:

M.O. = MASONRY OPENING
 VALUES IN () ARE IN MILLIMETER CONVERSIONS
 E. UNIT MEETS EGRESS REQUIREMENT FOR IRC CODE. STATE AND LOCAL EGRESS CODES MAY DIFFER. ALWAYS REFER TO LOCAL BUILDING CODES FOR COMPLETE REQUIREMENTS. CHECK WITH LOCAL OFFICIALS TO ENSURE COMPLIANCE BEFORE INSTALLING THE UNIT.
 E1. BASIC UNIT CLEAR OPENING EXCEEDS 20" IN WIDTH, 24" IN HEIGHT & A MINIMUM OF 5.0 SQ. FT., FOR FIRST FLOOR EGRESS.
 T. BASIC UNIT IS NOT AVAILABLE WITH TRI-PANE GLASS.
 ##. NUMBER INDICATES DESIGN PRESSURE (DP) RATING WITH STANDARD GLASS.
 ###. NUMBER INDICATES HIGHER DP RATING, TALLER SILL STOP AND IMPACT GLAZING.
 Note: Elevations shown DO NOT have exterior trim. Subtract 1/2"(12.7) from M.O.(Masonry Opening) for Unit Sizes. Masonry openings above include Sill Nose, see Trim Options page for Sill Nose specifications. For other Trim Options refer to the Unit Sizing, Rough Opening & Masonry Openings page.

REVERSE COTTAGE SINGLE UNITS
ELEVATIONS

MO BRICKMOLD
MO FLAT CASING
ROUGH OPENING
FRAME SIZE
DAYLIGHT OPENING

44 5/8"(1133)
47 11/16"(1211)
42 1/8"(1070)
41 3/8"(1051)
35 7/16"(900)

48 5/8"(1235)
51 11/16"(1313)
46 1/8"(1172)
45 3/8"(1153)
39 7/16"(1002)

50 13/32"(1280)
51 15/16"(1319)
48 3/4"(1238)
48"(1219)
22 13/16"(579)
15 7/16"(392)

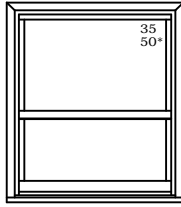

CWD4148R16

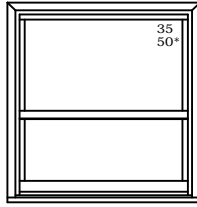

CWD4548R16

58 13/32"(1484)
59 15/16"(1522)
56 3/4"(1441)
56"(1422)
26 13/16"(681)
19 7/16"(494)

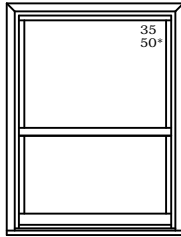

CWD4156R20

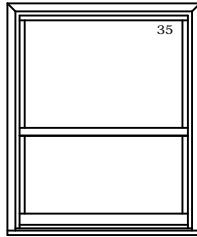

CWD4556R20

66 13/32"(1687)
67 15/16"(1726)
64 3/4"(1645)
64"(1626)
30 13/16"(783)
21 7/16"(545)

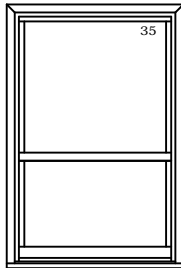

CWD4164R22

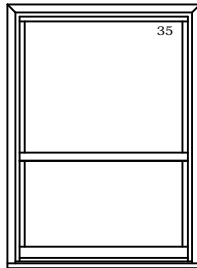

CWD4564R22

70 13/32"(1788)
71 15/16"(1827)
68 3/4"(1746)
68"(1727)
34 13/16"(884)
23 7/16"(595)

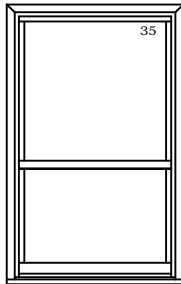

CWD4168R24

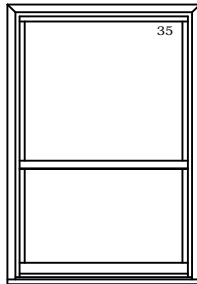

CWD4568R24

ELEVATION SYMBOL LEGEND:

- M.O. = MASORNY OPENING
- VALUES IN () ARE IN MILLIMETER CONVERSIONS
- E UNIT MEETS EGRESS REQUIREMENT FOR IRC CODE. STATE AND LOCAL EGRESS CODES MAY DIFFER. ALWAYS REFER TO LOCAL BUILDING CODES FOR COMPLETE REQUIREMENTS. CHECK WITH LOCAL OFFICIALS TO ENSURE COMPLIANCE BEFORE INSTALLING THE UNIT.
- E1 BASIC UNIT CLEAR OPENING EXCEEDS 20" IN WIDTH, 24" IN HEIGHT & A MINIMUM OF 5.0 SQ. FT., FOR FIRST FLOOR EGRESS.
- T BASIC UNIT IS NOT AVAILABLE WITH TRI-PANE GLASS.
- ## NUMBER INDICATES DESIGN PRESSURE (DP) RATING WITH STANDARD GLASS.
- ##* NUMBER INDICATES HIGHER DP RATING, TALLER SILL STOP AND IMPACT GLAZING.

Note: Elevations shown DO NOT have exterior trim. Subtract 1/2"(12.7) from M.O.(Masonry Opening) for Unit Sizes. Masonry openings above include Sill Nose, see Trim Options page for Sill Nose specifications. For other Trim Options refer to the Unit Sizing, Rough Opening & Masonry Openings page.

REVERSE COTTAGE 2 WIDE UNITS
ELEVATIONS

MO BRICKMOLD	46"(1168)	54"(1372)	62"(1575)	66"(1676)	70"(1778)	74"(1880)	78"(1981)
MO FLAT CASING	49 1/16"(1246)	57 1/16"(1449)	64 1/16"(1627)	68 1/16"(1729)	72 1/16"(1830)	76 1/16"(1932)	80 1/16"(2034)
ROUGH OPENING	43 1/2"(1105)	51 1/2"(1283)	59 1/2"(1511)	63 1/2"(1613)	67 1/2"(1715)	71 1/2"(1816)	75 1/2"(1918)
FRAME SIZE	42 3/4"(1086)	50 3/4"(1289)	58 3/4"(1492)	62 3/4"(1594)	66 3/4"(1695)	70 3/4"(1797)	74 3/4"(1899)
DAYLIGHT OPENING	15 7/16"[2](392)[2]	19 7/16"[2](494)[2]	23 7/16"[2](595)[2]	25 7/16"[2](646)[2]	27 7/16"[2](697)[2]	29 7/16"[2](740)[2]	31 7/16"[2](799)[2]

50 13/32"(1280) 51 15/16"(1319) 48 3/4"(1238) 48 1/2"(1219) 22 13/16"(579) 15 7/16"(392)							
CWD2148R16-2	CWD2548R16-2	CWD2948R16-2	CWD3148R16-2	CWD3348R16-2	CWD3548R16-2	CWD3748R16-2	
58 13/32"(1484) 59 15/16"(1522) 56 3/4"(1441) 56 1/2"(1422) 26 13/16"(681) 19 7/16"(494)							
CWD2156R20-2	CWD2556R20-2	CWD2956R20-2	CWD3156R20-2	CWD3356R20-2	CWD3556R20-2	CWD3756R20-2	
66 13/32"(1687) 67 15/16"(1726) 64 3/4"(1645) 64 1/2"(1626) 32 13/16"(833) 21 7/16"(645)							
CWD2164R22-2	CWD2564R22-2	CWD2964R22-2	CWD3164R22-2	CWD3364R22-2	CWD3564R22-2	CWD3764R22-2	
70 13/32"(1788) 71 15/16"(1827) 68 3/4"(1746) 68 1/2"(1727) 34 13/16"(864) 23 7/16"(695)							
CWD2168R24-2	CWD2568R24-2	CWD2968R24-2	CWD3168R24-2	CWD3368R24-2	CWD3568R24-2	CWD3768R24-2	
82 13/32"(2093) 83 15/16"(2132) 80 3/4"(2051) 80 1/2"(2032) 38 13/16"(966) 31 7/16"(799)							
CWD2180R32-2	CWD2580R32-2	CWD2980R32-2	CWD3180R32-2	CWD3380R32-2	CWD3580R32-2	CWD3780R32-2	

ELEVATION SYMBOL LEGEND:

- M.O. = MASORNY OPENING
- VALUES IN () ARE IN MILLIMETER CONVERSIONS
- VALUES IN [] ARE NUMBER OF DAYLIGHT OPENINGS PER UNIT
- E UNIT MEETS EGRESS REQUIREMENT FOR IRC CODE. STATE AND LOCAL EGRESS CODES MAY DIFFER. ALWAYS REFER TO LOCAL BUILDING CODES FOR COMPLETE REQUIREMENTS. CHECK WITH LOCAL OFFICIALS TO ENSURE COMPLIANCE BEFORE INSTALLING THE UNIT.
- E1 BASIC UNIT CLEAR OPENING EXCEEDS 20" IN WIDTH, 24" IN HEIGHT & A MINIMUM OF 5.0 SQ. FT., FOR FIRST FLOOR EGRESS.
- T BASIC UNIT IS NOT AVAILABLE WITH TRI-PANE GLASS.
- ## NUMBER INDICATES DESIGN PRESSURE (DP) RATING WITH STANDARD GLASS.
- ##* NUMBER INDICATES HIGHER DP RATING, TALLER SILL STOP AND IMPACT GLAZING.

Note: Elevations shown DO NOT have exterior trim. Subtract 1/2"(12.7) from M.O.(Masonry Opening) for Unit Sizes. Masonry openings above include Sill Nose, see Trim Options page for Sill Nose specifications. For other Trim Options refer to the Unit Sizing, Rough Opening & Masonry Openings page.

REVERSE COTTAGE 2 WIDE UNITS
ELEVATIONS

MO BRICKMOLD	86"(2184)	94"(2388)
MO FLAT CASING	88 1/16"(2237)	96 1/16"(2440)
ROUGH OPENING	83 1/2"(2121)	91 1/2"(2324)
FRAME SIZE	82 3/4"(2102)	90 3/4"(2305)
DAYLIGHT OPENING	35 7/16"[2](900)[2]	39 7/16"[2](1002)[2]

50 13/32"(1280)
51 15/16"(1319)
48 3/4"(1238)
48 1/2"(1219)
22 13/16"(579)
15 7/16"(392)

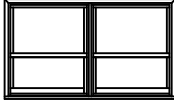

CWD4148R16-2

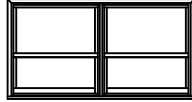

CWD4548R16-2

58 13/32"(1484)
59 15/16"(1522)
56 3/4"(1441)
56 1/2"(1422)
26 13/16"(681)
19 7/16"(494)

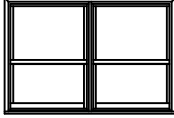

CWD4156R20-2

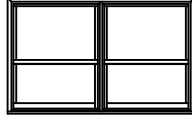

CWD4556R20-2

66 13/32"(1687)
67 15/16"(1726)
64 3/4"(1645)
64 1/2"(1626)
32 13/16"(833)
21 7/16"(545)

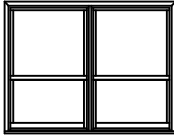

CWD4164R22-2

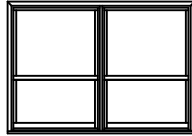

CWD4564R22-2

70 13/32"(1788)
71 15/16"(1827)
68 3/4"(1746)
68 1/2"(1727)
34 13/16"(884)
23 7/16"(595)

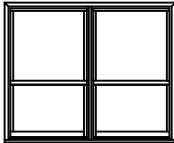

CWD4168R24-2

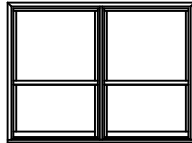

CWD4568R24-2

ELEVATION SYMBOL LEGEND:

- M.O. = MASORNY OPENING
- VALUES IN () ARE IN MILLIMETER CONVERSIONS
- VALUES IN [] ARE NUMBER OF DAYLIGHT OPENINGS PER UNIT
- E UNIT MEETS EGRESS REQUIREMENT FOR IRC CODE. STATE AND LOCAL EGRESS CODES MAY DIFFER. ALWAYS REFER TO LOCAL BUILDING CODES FOR COMPLETE REQUIREMENTS. CHECK WITH LOCAL OFFICIALS TO ENSURE COMPLIANCE BEFORE INSTALLING THE UNIT.
- E1 BASIC UNIT CLEAR OPENING EXCEEDS 20" IN WIDTH, 24" IN HEIGHT & A MINIMUM OF 5.0 SQ. FT., FOR FIRST FLOOR EGRESS.
- T BASIC UNIT IS NOT AVAILABLE WITH TRI-PANE GLASS.
- ## NUMBER INDICATES DESIGN PRESSURE (DP) RATING WITH STANDARD GLASS.
- ### NUMBER INDICATES HIGHER DP RATING, TALLER SILL STOP AND IMPACT GLAZING.

Note: Elevations shown DO NOT have exterior trim. Subtract 1/2"(12.7) from M.O.(Masonry Opening) for Unit Sizes. Masonry openings above include Sill Nose, see Trim Options page for Sill Nose specifications. For other Trim Options refer to the Unit Sizing, Rough Opening & Masonry Openings page.

REVERSE COTTAGE 3 WIDE UNITS
ELEVATIONS

MO BRICKMOLD	67 3/8"(1711)	79 3/8"(2016)	91 3/8"(2321)	97 3/8"(2473)	103 3/8"(2626)
MO FLAT CASING	70 7/16"(1789)	82 7/16"(2094)	94 7/16"(2399)	100 7/16"(2551)	106 7/16"(2704)
ROUGH OPENING	64 7/8"(1648)	76 7/8"(1946)	88 7/8"(2257)	94 7/8"(2410)	100 7/8"(2556)
FRAME SIZE	64 1/8"(1629)	76 1/8"(1934)	88 1/8"(2238)	94 1/8"(2391)	100 1/8"(2543)
DAYLIGHT OPENING	15 7/16"[3](392)[3]	19 7/16"[3](494)[3]	23 7/16"[3](595)[3]	25 7/16"[3](646)[3]	27 7/16"[3](697)[3]
50 13/32"(1280) 51 15/16"(1319) 48 3/4"(1238) 48"(1219) 48"(1219) 22 13/16"(579) 15 7/16"(392)					
58 13/32"(1484) 59 15/16"(1522) 56 3/4"(1441) 56"(1422) 26 13/16"(681) 19 7/16"(494)					
66 13/32"(1687) 67 15/16"(1726) 64 3/4"(1645) 64"(1626) 32 13/16"(833) 21 7/16"(545)					
70 13/32"(1788) 71 15/16"(1827) 68 3/4"(1746) 68"(1727) 34 13/16"(884) 23 7/16"(595)					
82 13/32"(2093) 83 15/16"(2132) 80 3/4"(2051) 80"(2032) 38 13/16"(986) 31 7/16"(799)					

ELEVATION SYMBOL LEGEND:
M.O. = MASORNY OPENING
VALUES IN () ARE IN MILLIMETER CONVERSIONS
VALUES IN [] ARE NUMBER OF DAYLIGHT OPENINGS PER UNIT
E UNIT MEETS EGRESS REQUIREMENT FOR IRC CODE. STATE AND LOCAL EGRESS CODES MAY DIFFER. ALWAYS REFER TO LOCAL BUILDING CODES FOR COMPLETE REQUIREMENTS. CHECK WITH LOCAL OFFICIALS TO ENSURE COMPLIANCE BEFORE INSTALLING THE UNIT.
E1 BASIC UNIT CLEAR OPENING EXCEEDS 20" IN WIDTH, 24" IN HEIGHT & A MINIMUM OF 5.0 SQ. FT., FOR FIRST FLOOR EGRESS.
T BASIC UNIT IS NOT AVAILABLE WITH TRI-PANE GLASS.
NUMBER INDICATES DESIGN PRESSURE (DP) RATING WITH STANDARD GLASS.
NUMBER INDICATES HIGHER DP RATING, TALLER SILL STOP AND IMPACT GLAZING.

Note: Elevations shown DO NOT have exterior trim. Subtract 1/2"(12.7) from M.O.(Masonry Opening) for Unit Sizes. Masonry openings above include Sill Nose, see Trim Options page for Sill Nose specifications. For other Trim Options refer to the Unit Sizing, Rough Opening & Masonry Openings page.

REVERSE COTTAGE 3 WIDE UNITS
ELEVATIONS

MO BRICKMOLD
MO FLAT CASING
ROUGH OPENING
FRAME SIZE
DAYLIGHT OPENING

109 3/8"(2778)
112 7/16"(2856)
106 7/8"(2715)
106 1/8"(2696)
29 7/16"[3](748)[3]

115 3/8"(2931)
118 7/16"(3008)
112 7/8"(2867)
112 1/8"(2848)
31 7/16"[3](799)[3]

127 3/8"(3235)
130 7/16"(3313)
124 7/8"(3172)
124 1/8"(3153)
35 7/16"[3](900)[3]

139 3/8"(3540)
142 7/16"(3618)
136 7/8"(3477)
136 1/8"(3458)
39 7/16"[3](1002)[3]

50 13/32"(1260)
51 15/16"(1319)
48 3/4"(1238)
48 1/2"(1219)
22 13/16"(579)
15 7/16"(392)

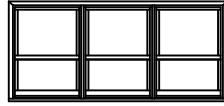

CWD3548R16-3



CWD3748R16-3

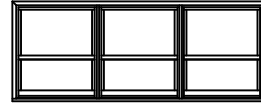

CWD4148R16-3

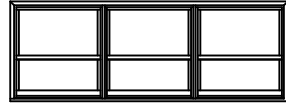

CWD4548R16-3

58 13/32"(1484)
59 15/16"(1522)
56 3/4"(1441)
56 1/4"(1423)
26 13/16"(681)
19 7/16"(494)

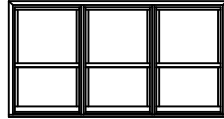

CWD3556R20-3

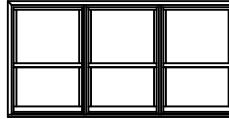

CWD3756R20-3

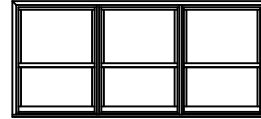

CWD4156R20-3

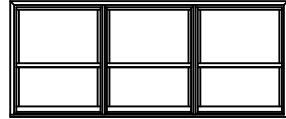

CWD4556R20-3

66 13/32"(1587)
67 15/16"(1626)
64 3/4"(1645)
64 1/2"(1619)
32 13/16"(833)
21 7/16"(545)

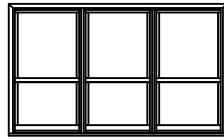

CWD3564R22-3

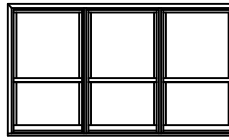

CWD3764R22-3

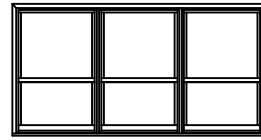

CWD4164R22-3

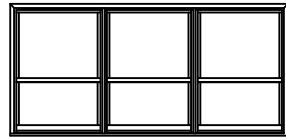

CWD4564R22-3

70 13/32"(1758)
71 15/16"(1827)
68 3/4"(1746)
68 1/2"(1727)
34 13/16"(884)
23 7/16"(595)

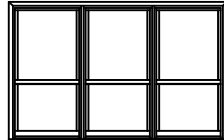

CWD3568R24-3

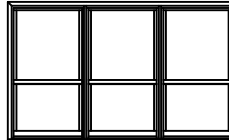

CWD3768R24-3

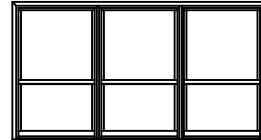

CWD4168R24-3

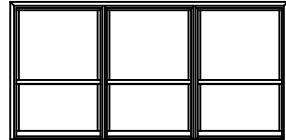

CWD4568R24-3

82 13/32"(2093)
83 15/16"(2132)
80 3/4"(2051)
80 1/2"(2032)
38 13/16"(986)
31 7/16"(799)

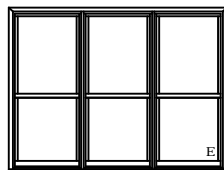

CWD3580R32-3

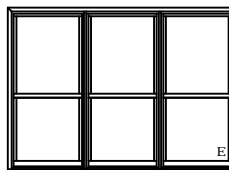

CWD3780R32-3

ELEVATION SYMBOL LEGEND:

- M.O. = MASORNY OPENING
- VALUES IN () ARE IN MILLIMETER CONVERSIONS
- VALUES IN [] ARE NUMBER OF DAYLIGHT OPENINGS PER UNIT
- E UNIT MEETS EGRESS REQUIREMENT FOR IRC CODE. STATE AND LOCAL EGRESS CODES MAY DIFFER. ALWAYS REFER TO LOCAL BUILDING CODES FOR COMPLETE REQUIREMENTS. CHECK WITH LOCAL OFFICIALS TO ENSURE COMPLIANCE BEFORE INSTALLING THE UNIT.
- E1 BASIC UNIT CLEAR OPENING EXCEEDS 20" IN WIDTH, 24" IN HEIGHT & A MINIMUM OF 5.0 SQ. FT., FOR FIRST FLOOR EGRESS.
- T BASIC UNIT IS NOT AVAILABLE WITH TRI-PANE GLASS.
- ## NUMBER INDICATES DESIGN PRESSURE (DP) RATING WITH STANDARD GLASS.
- ### NUMBER INDICATES HIGHER DP RATING, TALLER SILL STOP AND IMPACT GLAZING.

Note: Elevations shown DO NOT have exterior trim. Subtract 1/2"(12.7) from M.O.(Masonry Opening) for Unit Sizes. Masonry openings above include Sill Nose, see Trim Options page for Sill Nose specifications. For other Trim Options refer to the Unit Sizing, Rough Opening & Masonry Openings page.

30° BAY WINDOW W/ 21" FLANKERS
ELEVATIONS

	66 3/16"(1681)	86 3/16"(2189)	94 3/16"(2392)	98 3/16"(2494)	106 3/16"(2697)
MO BRICKMOLD	66 3/16"(1681)	86 3/16"(2189)	94 3/16"(2392)	98 3/16"(2494)	106 3/16"(2697)
MO FLAT CASING	69 1/4"(1759)	89 1/4"(2267)	97 1/4"(2470)	101 1/4"(2572)	109 1/4"(2775)
ROUGH OPENING	63 11/16"(1618)	83 11/16"(2126)	91 11/16"(2329)	95 11/16"(2430)	103 11/16"(2634)
FRAME SIZE	62 15/16"(1599)	82 15/16"(2107)	90 15/16"(2310)	94 15/16"(2411)	102 15/16"(2613)
DAYLIGHT OPENING	15 7/16"(392)[2] 16 7/16"(418)	15 7/16"(392)[2] 35 7/16"(900)	15 7/16"(392)[2] 43 7/16"(1103)	15 7/16"(392)[2] 47 7/16"(1205)	15 7/16"(392)[2] 55 7/16"(1408)
45 7/16"(1154) 47 1/16"(1194) 43 13/16"(1113) 43 1/16"(1094) 15 1/8"(384)[2] 32 3/8"(822)					
53 7/16"(1357) 55 1/16"(1397) 51 13/16"(1316) 51 1/16"(1297) 19 1/8"(486)[2] 40 3/8"(1026)					
61 7/16"(1560) 63 1/16"(1600) 59 13/16"(1519) 59 1/16"(1500) 23 1/8"(597)[2] 48 3/8"(1229)					
69 7/16"(1764) 71 1/8"(1803) 67 13/16"(1722) 67 1/16"(1703) 27 1/8"(689)[2] 56 3/8"(1432)					
73 7/16"(1865) 75 1/16"(1905) 71 13/16"(1824) 71 1/16"(1805) 29 1/16"(740)[2] 60 3/8"(1534)					

ELEVATION SYMBOL LEGEND:

- M.O. = MASONRY OPENING
- VALUES IN () ARE IN MILLIMETER CONVERSIONS
- VALUES IN [] ARE NUMBER OF DAYLIGHT OPENINGS PER UNIT
- E UNIT MEETS EGRESS REQUIREMENT FOR IRC CODE. STATE AND LOCAL EGRESS CODES MAY DIFFER. ALWAYS REFER TO LOCAL BUILDING CODES FOR COMPLETE REQUIREMENTS. CHECK WITH LOCAL OFFICIALS TO ENSURE COMPLIANCE BEFORE INSTALLING THE UNIT.
- E1 BASIC UNIT CLEAR OPENING EXCEEDS 20" IN WIDTH, 24" IN HEIGHT & A MINIMUM OF 5.0 SQ. FT., FOR FIRST FLOOR EGRESS.
- T BASIC UNIT IS NOT AVAILABLE WITH TRI-PANE GLASS.
- ## NUMBER INDICATES DESIGN PRESSURE (DP) RATING WITH STANDARD GLASS.
- ##* NUMBER INDICATES HIGHER DP RATING, TALLER SILL STOP AND IMPACT GLAZING.

Note: Elevations shown DO NOT have exterior trim. Subtract 1/2"(12.7) from M.O.(Masonry Opening) for Unit Sizes. Masonry openings above include Sill Nose, see Trim Options page for Sill Nose specifications. For other Trim Options refer to the Unit Sizing, Rough Opening & Masonry Openings page.

30° BAY WINDOW W/ 21" FLANKERS
ELEVATIONS

MO BRICKMOLD	114 3/16"(2900)
MO FLAT CASING	117 1/4"(2978)
ROUGH OPENING	111 11/16"(2837)
FRAME SIZE	110 15/16"(2818)
DAYLIGHT OPENING	15 7/16"(392) [2]
	63 7/16"(1611)



CWD3Y6940-21



CWD3Y6948-21



CWD3Y6956-21



CWD3Y6964-21



CWD3Y6968-21

ELEVATION SYMBOL LEGEND:

- M.O. = MASORNY OPENING
- VALUES IN () ARE IN MILLIMETER CONVERSIONS
- VALUES IN [] ARE NUMBER OF DAYLIGHT OPENINGS PER UNIT
- E UNIT MEETS EGRESS REQUIREMENT FOR IRC CODE. STATE AND LOCAL EGRESS CODES MAY DIFFER. ALWAYS REFER TO LOCAL BUILDING CODES FOR COMPLETE REQUIREMENTS. CHECK WITH LOCAL OFFICIALS TO ENSURE COMPLIANCE BEFORE INSTALLING THE UNIT.
- E1 BASIC UNIT CLEAR OPENING EXCEEDS 20" IN WIDTH, 24" IN HEIGHT & A MINIMUM OF 5.0 SQ. FT., FOR FIRST FLOOR EGRESS.
- T BASIC UNIT IS NOT AVAILABLE WITH TRI-PANE GLASS.
- ## NUMBER INDICATES DESIGN PRESSURE (DP) RATING WITH STANDARD GLASS.
- ##* NUMBER INDICATES HIGHER DP RATING, TALLER SILL STOP AND IMPACT GLAZING.

Note: Elevations shown DO NOT have exterior trim. Subtract 1/2"(12.7) from M.O.(Masonry Opening) for Unit Sizes. Masonry openings above include Sill Nose, see Trim Options page for Sill Nose specifications. For other Trim Options refer to the Unit Sizing, Rough Opening & Masonry Openings page.

30° BAY WINDOW W/ 25" FLANKERS
ELEVATIONS

MASONRY OPENING	77 1/8"(1959)	93 1/8"(2365)	101 1/8"(2569)	105 1/8"(2670)	113 1/8"(2873)
MASONRY OPENING	80 3/16"(2037)	96 3/16"(2443)	104 3/16"(2646)	108 3/16"(2748)	116 3/16"(2951)
ROUGH OPENING	74 5/8"(1895)	90 5/8"(2301)	98 5/8"(2505)	102 5/8"(2607)	110 5/8"(2810)
FRAME SIZE	73 7/8"(1876)	89 7/8"(2283)	97 7/8"(2486)	101 7/8"(2588)	109 7/8"(2791)
DAYLIGHT OPENING	19 7/16"(494)[2]	19 7/16"(494)[2]	19 7/16"(494)[2]	19 7/16"(494)[2]	19 7/16"(494)[2]
	16 7/16"(418)	35 7/16"(900)	43 7/16"(1103)	47 7/16"(1205)	55 7/16"(1408)
45 7/16"(1154) 47 1/16" 43 13/16"(1113) 43 1/16"(1094) 15 1/8"(384)[2] 32 3/8"(822)					
	CWD3Y2540-25	CWD3Y4140-25	CWD3Y4940-25	CWD3Y5340-25	CWD3Y6140-25
53 7/16"(1357) 55 1/16"(1397) 51 13/16"(1316) 51 1/16"(1297) 19 1/8"(486)[2] 40 3/8"(1026)					
	CWD3Y2548-25	CWD3Y4148-25	CWD3Y4948-25	CWD3Y5348-25	CWD3Y6148-25
61 7/16"(1560) 63 1/16" 59 13/16"(1519) 59 1/16"(1500) 23 1/8"(587)[2] 48 3/8"(1225)					
	CWD3Y2556-25	CWD3Y4156-25	CWD3Y4956-25	CWD3Y5356-25	CWD3Y6156-25
69 7/16"(1764) 71 1/16" 67 13/16"(1722) 67 1/16"(1703) 27 1/8"(689)[2] 56 3/8"(1432)					
	CWD3Y2564-25	CWD3Y4164-25	CWD3Y4964-25	CWD3Y5364-25	CWD3Y6164-25
73 7/16"(1865) 75 1/16" 71 13/16"(1824) 71 1/16"(1805) 29 1/16"(740)[2] 60 3/8"(1534)					
	CWD3Y2568-25	CWD3Y4168-25	CWD3Y4968-25	CWD3Y5368-25	CWD3Y6168-25

ELEVATION SYMBOL LEGEND:

- M.O. = MASONRY OPENING
- VALUES IN () ARE IN MILLIMETER CONVERSIONS
- VALUES IN [] ARE NUMBER OF DAYLIGHT OPENINGS PER UNIT
- E UNIT MEETS EGRESS REQUIREMENT FOR IRC CODE. STATE AND LOCAL EGRESS CODES MAY DIFFER. ALWAYS REFER TO LOCAL BUILDING CODES FOR COMPLETE REQUIREMENTS. CHECK WITH LOCAL OFFICIALS TO ENSURE COMPLIANCE BEFORE INSTALLING THE UNIT.
- E1 BASIC UNIT CLEAR OPENING EXCEEDS 20" IN WIDTH, 24" IN HEIGHT & A MINIMUM OF 5.0 SQ. FT., FOR FIRST FLOOR EGRESS.
- T BASIC UNIT IS NOT AVAILABLE WITH TRI-PANE GLASS.
- ## NUMBER INDICATES DESIGN PRESSURE (DP) RATING WITH STANDARD GLASS.
- ##* NUMBER INDICATES HIGHER DP RATING, TALLER SILL STOP AND IMPACT GLAZING.

Note: Elevations shown DO NOT have exterior trim. Subtract 1/2"(12.7) from M.O. (Masonry Opening) for Unit Sizes. Masonry openings above include Sill Nose, see Trim Options page for Sill Nose specifications. For other Trim Options refer to the Unit Sizing, Rough Opening & Masonry Openings page.

30° BAY WINDOW W/ 25" FLANKERS
ELEVATIONS

MO BRICKMOLD	121 1/8"(3077)
MO FLAT CASING	124 3/16"(3154)
ROUGH OPENING	118 5/8"(3013)
FRAME SIZE	117 7/8"(2994)
DAYLIGHT OPENING	19 7/16"(494)[2] 63 7/16"(1611)

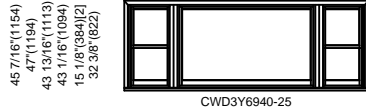

CWD3Y6940-25



CWD3Y6948-25



CWD3Y6956-25

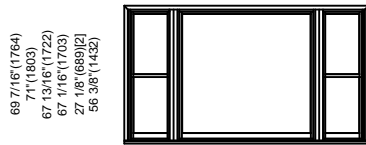

CWD3Y6964-25

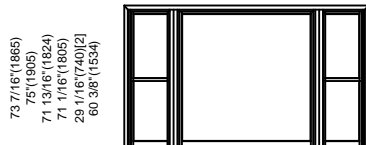

CWD3Y6968-25

ELEVATION SYMBOL LEGEND:

- M.O. = MASORY OPENING
- VALUES IN () ARE IN MILLIMETER CONVERSIONS
- VALUES IN [] ARE NUMBER OF DAYLIGHT OPENINGS PER UNIT
- E UNIT MEETS EGRESS REQUIREMENT FOR IRC CODE. STATE AND LOCAL EGRESS CODES MAY DIFFER. ALWAYS REFER TO LOCAL BUILDING CODES FOR COMPLETE REQUIREMENTS. CHECK WITH LOCAL OFFICIALS TO ENSURE COMPLIANCE BEFORE INSTALLING THE UNIT.
- E1 BASIC UNIT CLEAR OPENING EXCEEDS 20" IN WIDTH, 24" IN HEIGHT & A MINIMUM OF 5.0 SQ. FT., FOR FIRST FLOOR EGRESS.
- T BASIC UNIT IS NOT AVAILABLE WITH TRI-PANE GLASS.
- # NUMBER INDICATES DESIGN PRESSURE (DP) RATING WITH STANDARD GLASS.
- ##* NUMBER INDICATES HIGHER DP RATING, TALLER SILL STOP AND IMPACT GLAZING.

Note: Elevations shown DO NOT have exterior trim. Subtract 1/2"(12.7) from M.O.(Masonry Opening) for Unit Sizes. Masonry openings above include Sill Nose, see Trim Options page for Sill Nose specifications. For other Trim Options refer to the Unit Sizing, Rough Opening & Masonry Openings page.

30° BAY WINDOW W/ 29" FLANKERS
ELEVATIONS

MO BRICKMOLD
MO FLAT CASING
ROUGH OPENING
FRAME SIZE
DAYLIGHT OPENING

88 1/16"(2237)
91 1/8"(2315)
85 9/16"(2173)
84 13/16"(2154)
23 7/16"(595)[2]
24 7/16"(621)

100 1/16"(2542)
103 1/8"(2619)
97 9/16"(2478)
96 13/16"(2459)
23 7/16"(595)[2]
35 7/16"(900)

108 1/16"(2745)
111 1/8"(2823)
105 9/16"(2681)
104 13/16"(2662)
23 7/16"(595)[2]
43 7/16"(1103)

112 1/16"(2846)
115 1/8"(2924)
109 9/16"(2783)
108 13/16"(2764)
23 7/16"(595)[2]
47 7/16"(1205)

45 7/16"(1154)
47 1/16"(1194)
43 13/16"(1113)
43 1/16"(1094)
15 1/8"(384)[2]
32 3/8"(822)

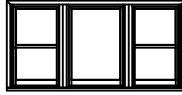

CWD3Y2940-29

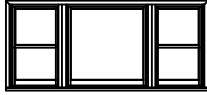

CWD3Y4140-29

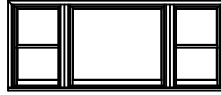

CWD3Y4940-29

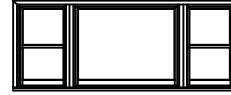

CWD3Y5340-29

53 7/16"(1357)
55 1/16"(1397)
51 13/16"(1316)
51 1/16"(1297)
19 1/8"(486)[2]
40 3/8"(1026)

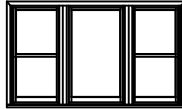

CWD3Y2948-29

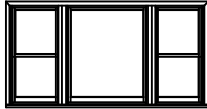

CWD3Y4148-29

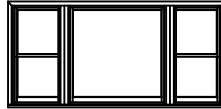

CWD3Y4948-29

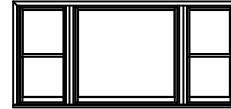

CWD3Y5348-29

61 7/16"(1560)
63 1/16"(1600)
59 13/16"(1519)
59 1/16"(1500)
23 1/8"(587)[2]
48 3/8"(1229)

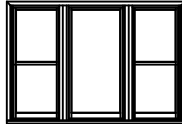

CWD3Y2956-29

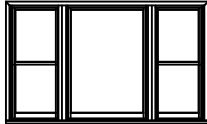

CWD3Y4156-29

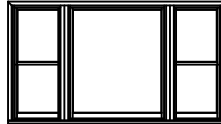

CWD3Y4956-29

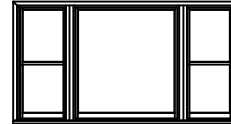

CWD3Y5356-29

69 7/16"(1764)
71 1/16"(1803)
67 13/16"(1722)
67 1/16"(1703)
27 1/8"(689)[2]
56 3/8"(1432)

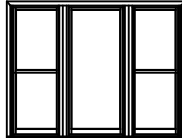

CWD3Y2964-29

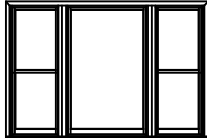

CWD3Y4164-29

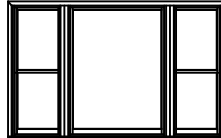

CWD3Y4964-29

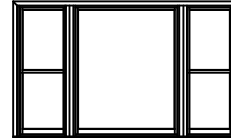

CWD3Y5364-29

73 7/16"(1865)
75 1/16"(1905)
71 13/16"(1824)
71 1/16"(1805)
29 1/16"(740)[2]
60 3/8"(1534)



CWD3Y2968-29



CWD3Y4168-29

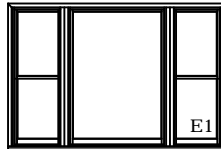

CWD3Y4968-29

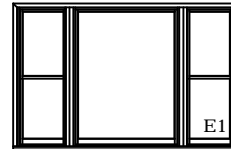

CWD3Y5368-29

ELEVATION SYMBOL LEGEND:

- M.O. = MASORNY OPENING
- VALUES IN () ARE IN MILLIMETER CONVERSIONS
- VALUES IN [] ARE NUMBER OF DAYLIGHT OPENINGS PER UNIT
- E UNIT MEETS EGRESS REQUIREMENT FOR IRC CODE. STATE AND LOCAL EGRESS CODES MAY DIFFER. ALWAYS REFER TO LOCAL BUILDING CODES FOR COMPLETE REQUIREMENTS. CHECK WITH LOCAL OFFICIALS TO ENSURE COMPLIANCE BEFORE INSTALLING THE UNIT.
- E1 BASIC UNIT CLEAR OPENING EXCEEDS 20" IN WIDTH, 24" IN HEIGHT & A MINIMUM OF 5.0 SQ. FT., FOR FIRST FLOOR EGRESS.
- T BASIC UNIT IS NOT AVAILABLE WITH TRI-PANE GLASS.
- ## NUMBER INDICATES DESIGN PRESSURE (DP) RATING WITH STANDARD GLASS.
- ##* NUMBER INDICATES HIGHER DP RATING, TALLER SILL STOP AND IMPACT GLAZING.

Note: Elevations shown DO NOT have exterior trim. Subtract 1/2"(12.7) from M.O.(Masonry Opening) for Unit Sizes. Masonry openings above include Sill Nose, see Trim Options page for Sill Nose specifications. For other Trim Options refer to the Unit Sizing, Rough Opening & Masonry Openings page.

30° BAY WINDOW W/ 29" FLANKERS
ELEVATIONS

MO BRICKMOLD
MO FLAT CASING
ROUGH OPENING
FRAME SIZE
DAYLIGHT OPENING

120 1/16"(3050)
123 1/8"(3127)
117 9/16"(2986)
116 13/16"(2967)
23 7/16"(595)[2]
55 7/16"(1408)

128 1/16"(3253)
131 1/8"(3331)
125 9/16"(3189)
124 13/16"(3170)
23 7/16"(595)[2]
63 7/16"(1611)

45 7/16"(1154)
47"(1194)
43 13/16"(1113)
43 1/16"(1094)
15 1/8"(384)[2]
32 3/8"(822)



CWD3Y6140-29



CWD3Y6940-29

53 7/16"(1357)
55"(1397)
51 13/16"(1316)
51 1/16"(1297)
19 1/8"(486)[2]
40 3/8"(1026)

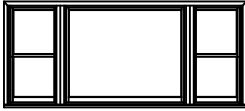

CWD3Y6148-29



CWD3Y6948-29

61 7/16"(1560)
63"(1600)
59 13/16"(1519)
59 1/16"(1500)
23 1/8"(587)[2]
48 3/8"(1229)

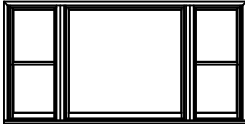

CWD3Y6156-29

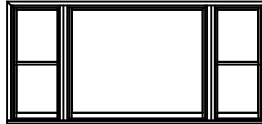

CWD3Y6956-29

69 7/16"(1764)
71"(1803)
67 13/16"(1722)
67 1/16"(1703)
27 1/8"(689)[2]
56 3/8"(1432)

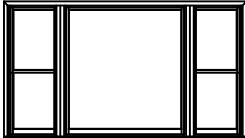

CWD3Y6164-29



CWD3Y6964-29

73 7/16"(1865)
75"(1905)
71 13/16"(1824)
71 1/16"(1805)
29 1/16"(740)[2]
60 3/8"(1534)

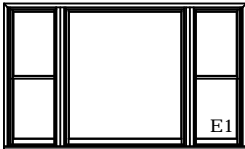

CWD3Y6168-29

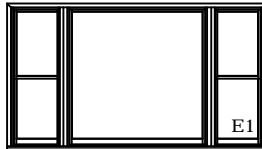

CWD3Y6968-29

ELEVATION SYMBOL LEGEND:

- M.O. = MASORNY OPENING
- VALUES IN () ARE IN MILLIMETER CONVERSIONS
- VALUES IN [] ARE NUMBER OF DAYLIGHT OPENINGS PER UNIT
- E UNIT MEETS EGRESS REQUIREMENT FOR IRC CODE. STATE AND LOCAL EGRESS CODES MAY DIFFER. ALWAYS REFER TO LOCAL BUILDING CODES FOR COMPLETE REQUIREMENTS. CHECK WITH LOCAL OFFICIALS TO ENSURE COMPLIANCE BEFORE INSTALLING THE UNIT.
- E1 BASIC UNIT CLEAR OPENING EXCEEDS 20" IN WIDTH, 24" IN HEIGHT & A MINIMUM OF 5.0 SQ. FT., FOR FIRST FLOOR EGRESS.
- T BASIC UNIT IS NOT AVAILABLE WITH TRI-PANE GLASS.
- ## NUMBER INDICATES DESIGN PRESSURE (DP) RATING WITH STANDARD GLASS.
- ##* NUMBER INDICATES HIGHER DP RATING, TALLER SILL STOP AND IMPACT GLAZING.

Note: Elevations shown DO NOT have exterior trim. Subtract 1/2"(12.7) from M.O.(Masonry Opening) for Unit Sizes. Masonry openings above include Sill Nose, see Trim Options page for Sill Nose specifications. For other Trim Options refer to the Unit Sizing, Rough Opening & Masonry Openings page.

45° BAY WINDOW W/ 21" FLANKERS
ELEVATIONS

MO BRICKMOLD
MO FLAT CASING
ROUGH OPENING
FRAME SIZE
DAYLIGHT OPENING

60 1/16"(1526)
63 1/8"(1603)
57 9/16"(1462)
56 13/16"(1443)
15 7/16"(392)[2]
16 7/16"(418)

80 1/16"(2034)
83 1/8"(2111)
77 9/16"(1970)
76 13/16"(1951)
15 7/16"(392)[2]
35 7/16"(900)

88 1/16"(2237)
91 1/8"(2315)
85 9/16"(2173)
84 13/16"(2154)
15 7/16"(392)[2]
43 7/16"(1103)

92 1/16"(2338)
95 1/8"(2416)
89 9/16"(2275)
88 13/16"(2256)
15 7/16"(392)[2]
47 7/16"(1205)

100 1/16"(2542)
103 1/8"(2619)
97 9/16"(2478)
96 13/16"(2459)
15 7/16"(392)[2]
55 7/16"(1408)

45 7/16"(1154)
47 1/16"(1194)
43 13/16"(1113)
43 1/8"(1084)
15 1/8"(384)[2]
32 3/8"(822)



CWD4Y2140-21

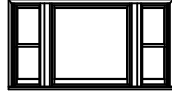

CWD4Y4140-21

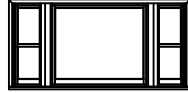

CWD4Y4940-21



CWD4Y5340-21



CWD4Y6140-21

53 7/16"(1357)
55 (1397)
51 13/16"(1316)
51 1/16"(1297)
19 1/8"(486)[2]
40 3/8"(1026)



CWD4Y2148-21

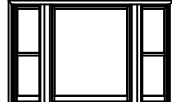

CWD4Y4148-21

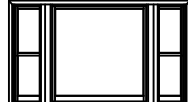

CWD4Y4948-21



CWD4Y5348-21



CWD4Y6148-21

61 7/16"(1560)
63 (1600)
59 13/16"(1519)
59 1/16"(1500)
23 1/8"(587)[2]
48 3/8"(1229)



CWD4Y2156-21

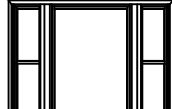

CWD4Y4156-21

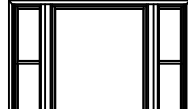

CWD4Y4956-21



CWD4Y5356-21

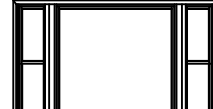

CWD4Y6156-21

69 7/16"(1764)
71 (1803)
67 13/16"(1722)
67 1/16"(1703)
27 1/8"(689)[2]
56 3/8"(1432)



CWD4Y2164-21

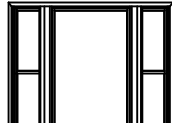

CWD4Y4164-21

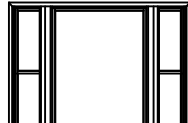

CWD4Y4964-21

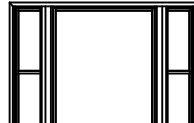

CWD4Y5364-21



CWD4Y6164-21

73 7/16"(1865)
75 (1905)
71 13/16"(1824)
71 1/16"(1806)
29 1/16"(740)[2]
60 3/8"(1534)



CWD4Y2168-21

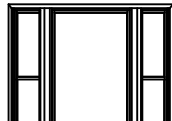

CWD4Y4168-21

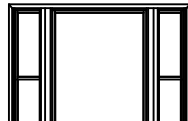

CWD4Y4968-21

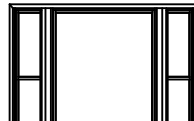

CWD4Y5368-21

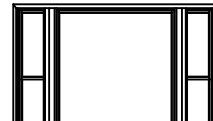

CWD4Y6168-21

ELEVATION SYMBOL LEGEND:

- M.O. = MASONRY OPENING
- VALUES IN () ARE IN MILLIMETER CONVERSIONS
- VALUES IN [] ARE NUMBER OF DAYLIGHT OPENINGS PER UNIT
- E UNIT MEETS EGRESS REQUIREMENT FOR IRC CODE. STATE AND LOCAL EGRESS CODES MAY DIFFER. ALWAYS REFER TO LOCAL BUILDING CODES FOR COMPLETE REQUIREMENTS. CHECK WITH LOCAL OFFICIALS TO ENSURE COMPLIANCE BEFORE INSTALLING THE UNIT.
- E1 BASIC UNIT CLEAR OPENING EXCEEDS 20" IN WIDTH, 24" IN HEIGHT & A MINIMUM OF 5.0 SQ. FT., FOR FIRST FLOOR EGRESS.
- T BASIC UNIT IS NOT AVAILABLE WITH TRI-PANE GLASS.
- ## NUMBER INDICATES DESIGN PRESSURE (DP) RATING WITH STANDARD GLASS.
- ##* NUMBER INDICATES HIGHER DP RATING, TALLER SILL STOP AND IMPACT GLAZING.

Note: Elevations shown DO NOT have exterior trim. Subtract 1/2"(12.7) from M.O.(Masonry Opening) for Unit Sizes. Masonry openings above include Sill Nose, see Trim Options page for Sill Nose specifications. For other Trim Options refer to the Unit Sizing, Rough Opening & Masonry Openings page.

45° BAY WINDOW W/ 21" FLANKERS
ELEVATIONS

MO BRICKMOLD	108 1/16"(2745)
MO FLAT CASING	111 1/8"(2823)
ROUGH OPENING	105 9/16"(2681)
FRAME SIZE	104 13/16"(2662)
DAYLIGHT OPENING	15 7/16"(392)[2]
	63 7/16"(1611)

45 7/16"(1154)
47"(1194)
43 13/16"(1113)
43 1/16"(1094)
15 1/8"(384)[2]
32 3/8"(822)



CWD4Y6940-21

53 7/16"(1357)
55"(1397)
51 13/16"(1316)
51 1/16"(1297)
19 1/8"(486)[2]
40 3/8"(1026)



CWD4Y6948-21

61 7/16"(1560)
63"(1600)
59 13/16"(1519)
59 1/16"(1500)
23 1/8"(587)[2]
48 3/8"(1229)

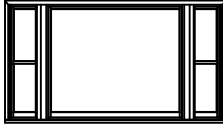

CWD4Y6956-21

69 7/16"(1764)
71"(1803)
67 13/16"(1722)
67 1/16"(1703)
27 1/8"(689)[2]
56 3/8"(1432)

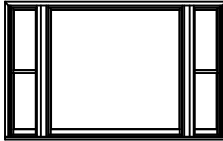

CWD4Y6964-21

73 7/16"(1865)
75"(1905)
71 13/16"(1824)
71 1/16"(1805)
29 1/16"(740)[2]
60 3/8"(1534)

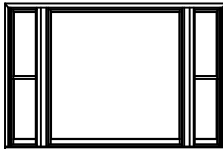

CWD4Y6968-21

ELEVATION SYMBOL LEGEND:

- M.O. = MASORNY OPENING
- VALUES IN () ARE IN MILLIMETER CONVERSIONS
- VALUES IN [] ARE NUMBER OF DAYLIGHT OPENINGS PER UNIT
- E UNIT MEETS EGRESS REQUIREMENT FOR IRC CODE, STATE AND LOCAL EGRESS CODES MAY DIFFER. ALWAYS REFER TO LOCAL BUILDING CODES FOR COMPLETE REQUIREMENTS. CHECK WITH LOCAL OFFICIALS TO ENSURE COMPLIANCE BEFORE INSTALLING THE UNIT.
- E1 BASIC UNIT CLEAR OPENING EXCEEDS 20" IN WIDTH, 24" IN HEIGHT & A MINIMUM OF 5.0 SQ. FT., FOR FIRST FLOOR EGRESS.
- T BASIC UNIT IS NOT AVAILABLE WITH TRI-PANE GLASS.
- ## NUMBER INDICATES DESIGN PRESSURE (DP) RATING WITH STANDARD GLASS.
- ##* NUMBER INDICATES HIGHER DP RATING, TALLER SILL STOP AND IMPACT GLAZING.

Note: Elevations shown DO NOT have exterior trim. Subtract 1/2"(12.7) from M.O.(Masonry Opening) for Unit Sizes. Masonry openings above include Sill Nose, see Trim Options page for Sill Nose specifications. For other Trim Options refer to the Unit Sizing, Rough Opening & Masonry Openings page.

45° BAY WINDOW W/ 25" FLANKERS
ELEVATIONS

MO BRICKMOLD
MO FLAT CASING
ROUGH OPENING
FRAME SIZE
DAYLIGHT OPENING

69 3/4"(1772)
72 13/16"(1849)
67 1/4"(1708)
66 1/2"(1689)
19 7/16"(494)[2]
20 7/16"(519)

85 3/4"(2178)
88 13/16"(2256)
83 1/4"(2115)
82 1/2"(2063)
19 7/16"(494)[2]
35 7/16"(900)

93 3/4"(2381)
96 13/16"(2459)
91 1/4"(2318)
90 1/2"(2299)
19 7/16"(494)[2]
43 7/16"(1103)

97 3/4"(2483)
100 13/16"(2561)
95 1/4"(2419)
94 1/2"(2400)
19 7/16"(494)[2]
47 7/16"(1205)

105 3/4"(2686)
108 13/16"(2764)
103 1/4"(2623)
102 1/2"(2604)
19 7/16"(494)[2]
55 7/16"(1408)

45 7/16"(1154)
47 1/4"(1194)
43 13/16"(1133)
43 1/8"(1084)
45 1/8"(1098)
32 3/8"(822)



CWD4Y2540-25

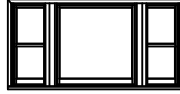

CWD4Y4140-25

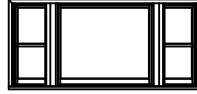

CWD4Y4940-25

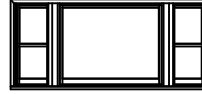

CWD4Y5340-25



CWD4Y6140-25

53 7/16"(1357)
55 1/8"(1397)
51 1/8"(1297)
51 1/8"(1297)
48 3/8"(1236)
40 3/8"(1026)



CWD4Y2548-25

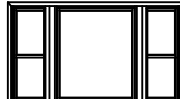

CWD4Y4148-25

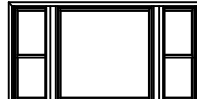

CWD4Y4948-25



CWD4Y5348-25



CWD4Y6148-25

61 7/16"(1560)
63 1/8"(1600)
59 1/8"(1500)
59 1/8"(1500)
28 1/8"(699)
48 3/8"(1228)

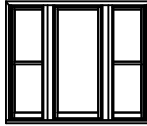

CWD4Y2556-25

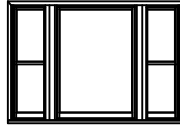

CWD4Y4156-25

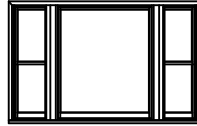

CWD4Y4956-25

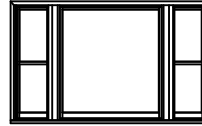

CWD4Y5356-25

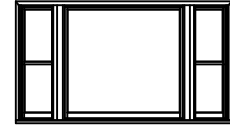

CWD4Y6156-25

69 7/16"(1764)
71 1/8"(1804)
67 1/8"(1704)
67 1/8"(1704)
27 1/8"(699)
56 3/8"(1432)

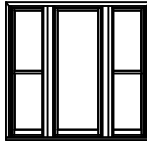

CWD4Y2564-25

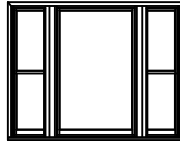

CWD4Y4164-25

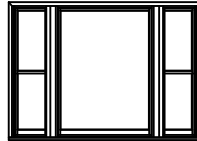

CWD4Y4964-25

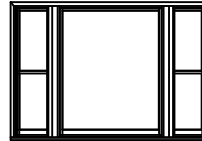

CWD4Y5364-25

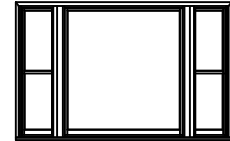

CWD4Y6164-25

73 7/16"(1868)
75 1/8"(1908)
71 1/8"(1808)
71 1/8"(1808)
29 1/8"(739)
60 3/8"(1534)

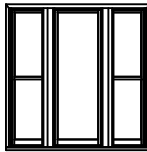

CWD4Y2568-25

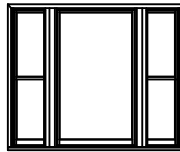

CWD4Y4168-25

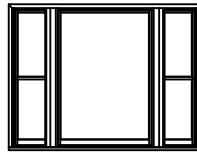

CWD4Y4968-25

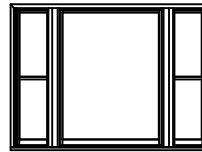

CWD4Y5368-25

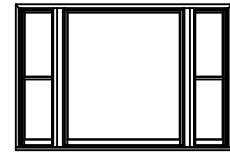

CWD4Y6168-25

ELEVATION SYMBOL LEGEND:

- M.O. = MASORNY OPENING
- VALUES IN () ARE IN MILLIMETER CONVERSIONS
- VALUES IN [] ARE NUMBER OF DAYLIGHT OPENINGS PER UNIT
- E UNIT MEETS EGRESS REQUIREMENT FOR IRC CODE. STATE AND LOCAL EGRESS CODES MAY DIFFER. ALWAYS REFER TO LOCAL BUILDING CODES FOR COMPLETE REQUIREMENTS. CHECK WITH LOCAL OFFICIALS TO ENSURE COMPLIANCE BEFORE INSTALLING THE UNIT.
- E1 BASIC UNIT CLEAR OPENING EXCEEDS 20" IN WIDTH, 24" IN HEIGHT & A MINIMUM OF 5.0 SQ. FT., FOR FIRST FLOOR EGRESS.
- T BASIC UNIT IS NOT AVAILABLE WITH TRI-PANE GLASS.
- # NUMBER INDICATES DESIGN PRESSURE (DP) RATING WITH STANDARD GLASS.
- ## NUMBER INDICATES HIGHER DP RATING, TALLER SILL STOP AND IMPACT GLAZING.

Note: Elevations shown DO NOT have exterior trim. Subtract 1/2"(12.7) from M.O.(Masonry Opening) for Unit Sizes. Masonry openings above include Sill Nose, see Trim Options page for Sill Nose specifications. For other Trim Options refer to the Unit Sizing, Rough Opening & Masonry Openings page.

45° BAY WINDOW W/ 25" FLANKERS
ELEVATIONS

MO BRICKMOLD	113 3/4"(2889)
MO FLAT CASING	116 13/16"(2967)
ROUGH OPENING	111 1/4"(2856)
FRAME SIZE	110 1/2"(2807)
DAYLIGHT OPENING	19 7/16"(494)[2]
	63 7/16"(1611)

45 7/16"(1154)
47"(1194)
43 13/16"(1113)
43 1/16"(1094)
15 1/8"(384)[2]
32 3/8"(822)



CWD4Y6940-25

53 7/16"(1357)
55"(1397)
51 13/16"(1316)
51 1/16"(1297)
19 1/8"(486)[2]
40 3/8"(1026)



CWD4Y6948-25

61 7/16"(1560)
63"(1600)
59 13/16"(1519)
59 1/16"(1500)
23 1/8"(587)[2]
48 3/8"(1229)

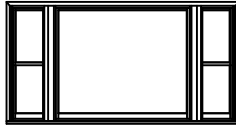

CWD4Y6956-25

69 7/16"(1764)
71"(1803)
67 13/16"(1722)
67 1/16"(1703)
27 1/8"(689)[2]
56 3/8"(1432)

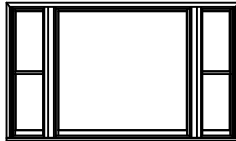

CWD4Y6964-25

73 7/16"(1865)
75"(1905)
71 13/16"(1824)
71 1/16"(1805)
29 1/16"(740)[2]
60 3/8"(1534)

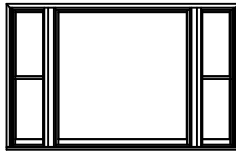

CWD4Y6968-25

ELEVATION SYMBOL LEGEND:

- M.O. = MASORNY OPENING
- VALUES IN () ARE IN MILLIMETER CONVERSIONS
- VALUES IN [] ARE NUMBER OF DAYLIGHT OPENINGS PER UNIT
- E UNIT MEETS EGRESS REQUIREMENT FOR IRC CODE. STATE AND LOCAL EGRESS CODES MAY DIFFER. ALWAYS REFER TO LOCAL BUILDING CODES FOR COMPLETE REQUIREMENTS. CHECK WITH LOCAL OFFICIALS TO ENSURE COMPLIANCE BEFORE INSTALLING THE UNIT.
- E1 BASIC UNIT CLEAR OPENING EXCEEDS 20" IN WIDTH, 24" IN HEIGHT & A MINIMUM OF 5.0 SQ. FT., FOR FIRST FLOOR EGRESS.
- T BASIC UNIT IS NOT AVAILABLE WITH TRI-PANE GLASS.
- ## NUMBER INDICATES DESIGN PRESSURE (DP) RATING WITH STANDARD GLASS.
- ##* NUMBER INDICATES HIGHER DP RATING, TALLER SILL STOP AND IMPACT GLAZING.

Note: Elevations shown DO NOT have exterior trim. Subtract 1/2"(12.7) from M.O.(Masonry Opening) for Unit Sizes. Masonry openings above include Sill Nose, see Trim Options page for Sill Nose specifications. For other Trim Options refer to the Unit Sizing, Rough Opening & Masonry Openings page.

45° BAY WINDOW W/ 29" FLANKERS
ELEVATIONS

MO BRICKMOLD
MO FLAT CASING
ROUGH OPENING
FRAME SIZE
DAYLIGHT OPENING

79 3/8"(2016)
82 7/16"(2094)
77 7/8"(1978)
76 1/8"(1934)
23 7/16"(595)[2]
24 7/16"(621)

91 3/8"(2321)
94 7/16"(2399)
89 7/8"(2283)
88 1/8"(2238)
23 7/16"(595)[2]
35 7/16"(900)

99 3/8"(2524)
102 7/16"(2602)
97 7/8"(2486)
96 1/8"(2442)
23 7/16"(595)[2]
43 7/16"(1103)

103 3/8"(2626)
106 7/16"(2704)
101 7/8"(2588)
100 1/8"(2543)
23 7/16"(595)[2]
47 7/16"(1205)

45 7/16"(1154)
47"(1194)
43 13/16"(1113)
43 1/16"(1094)
15 1/8"(384)[2]
32 3/8"(822)



CWD4Y2940-29

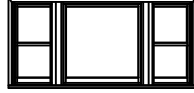

CWD4Y4140-29

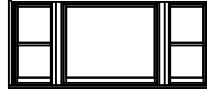

CWD4Y4940-29

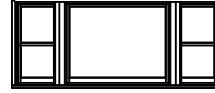

CWD4Y5340-29

53 7/16"(1357)
55"(1397)
51 13/16"(1316)
51 1/16"(1297)
19 1/8"(486)[2]
40 3/8"(1026)

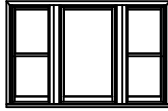

CWD4Y2948-29

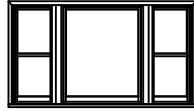

CWD4Y4148-29

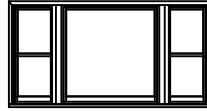

CWD4Y4948-29

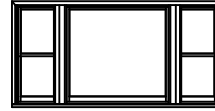

CWD4Y5348-29

61 7/16"(1560)
63"(1600)
59 13/16"(1519)
59 1/16"(1500)
23 1/8"(587)[2]
48 3/8"(1229)

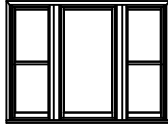

CWD4Y2956-29

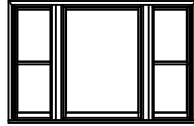

CWD4Y4156-29

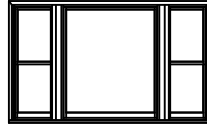

CWD4Y4956-29

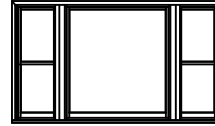

CWD4Y5356-29

69 7/16"(1764)
71"(1803)
67 13/16"(1722)
67 1/16"(1703)
27 1/8"(689)[2]
56 3/8"(1432)

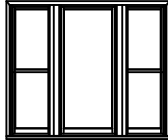

CWD4Y2964-29

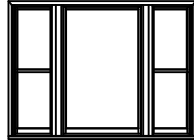

CWD4Y4164-29

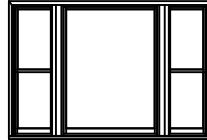

CWD4Y4964-29

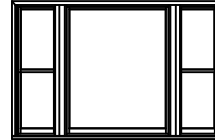

CWD4Y5364-29

73 7/16"(1865)
75"(1905)
71 13/16"(1824)
71 1/16"(1805)
29 1/16"(740)[2]
60 3/8"(1534)

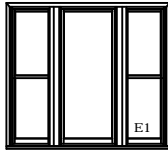

CWD4Y2968-29



CWD4Y4168-29

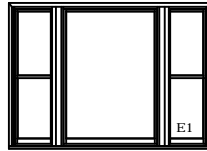

CWD4Y4968-29

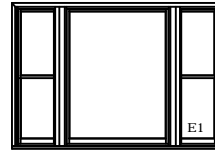

CWD4Y5368-29

ELEVATION SYMBOL LEGEND:

- M.O. = MASORNY OPENING
- VALUES IN () ARE IN MILLIMETER CONVERSIONS
- VALUES IN [] ARE NUMBER OF DAYLIGHT OPENINGS PER UNIT
- E UNIT MEETS EGRESS REQUIREMENT FOR IRC CODE. STATE AND LOCAL EGRESS CODES MAY DIFFER. ALWAYS REFER TO LOCAL BUILDING CODES FOR COMPLETE REQUIREMENTS. CHECK WITH LOCAL OFFICIALS TO ENSURE COMPLIANCE BEFORE INSTALLING THE UNIT.
- E1 BASIC UNIT CLEAR OPENING EXCEEDS 20" IN WIDTH, 24" IN HEIGHT & A MINIMUM OF 5.0 SQ. FT., FOR FIRST FLOOR EGRESS.
- T BASIC UNIT IS NOT AVAILABLE WITH TRI-PANE GLASS.
- ## NUMBER INDICATES DESIGN PRESSURE (DP) RATING WITH STANDARD GLASS.
- ##* NUMBER INDICATES HIGHER DP RATING, TALLER SILL STOP AND IMPACT GLAZING.

Note: Elevations shown DO NOT have exterior trim. Subtract 1/2"(12.7) from M.O.(Masonry Opening) for Unit Sizes. Masonry openings above include Sill Nose, see Trim Options page for Sill Nose specifications. For other Trim Options refer to the Unit Sizing, Rough Opening & Masonry Openings page.

45° BAY WINDOW W/ 29" FLANKERS
ELEVATIONS

MO BRICKMOLD
MO FLAT CASING
ROUGH OPENING
FRAME SIZE
DAYLIGHT OPENING

111 3/8"(2829)
114 7/16"(2907)
109 7/8"(2791)
108 1/8"(2746)
23 7/16"(595)[2]
55 7/16"(1408)

119 3/8"(3032)
122 7/16"(3109)
117 7/8"(2994)
116 1/8"(2950)
23 7/16"(595)[2]
63 7/16"(1611)

45 7/16"(1154)
47"(1194)
43 13/16"(1113)
43 1/16"(1094)
15 1/8"(384)[2]
32 3/8"(822)



CWD4Y6140-29



CWD4Y6940-29

53 7/16"(1357)
55"(1397)
51 13/16"(1316)
51 1/16"(1297)
19 1/8"(486)[2]
40 3/8"(1026)



CWD4Y6148-29



CWD4Y6948-29

61 7/16"(1560)
63"(1600)
59 13/16"(1519)
59 1/16"(1500)
23 1/8"(587)[2]
48 3/8"(1229)

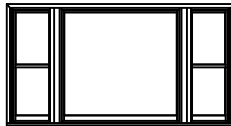

CWD4Y6156-29

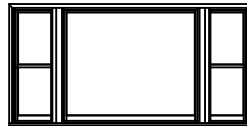

CWD4Y6956-29

69 7/16"(1764)
71"(1803)
67 13/16"(1722)
67 1/16"(1703)
27 1/8"(689)[2]
56 3/8"(1432)

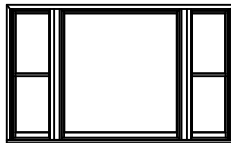

CWD4Y6164-29

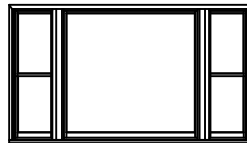

CWD4Y6964-29

73 7/16"(1865)
75"(1905)
71 13/16"(1824)
71 1/16"(1805)
29 1/16"(740)[2]
60 3/8"(1534)

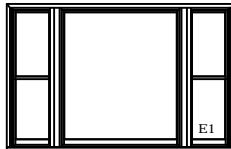

CWD4Y6168-29

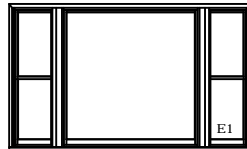

CWD4Y6968-29

ELEVATION SYMBOL LEGEND:

- M.O. = MASORNY OPENING
- VALUES IN () ARE IN MILLIMETER CONVERSIONS
- VALUES IN [] ARE NUMBER OF DAYLIGHT OPENINGS PER UNIT
- E UNIT MEETS EGRESS REQUIREMENT FOR IRC CODE. STATE AND LOCAL EGRESS CODES MAY DIFFER. ALWAYS REFER TO LOCAL BUILDING CODES FOR COMPLETE REQUIREMENTS. CHECK WITH LOCAL OFFICIALS TO ENSURE COMPLIANCE BEFORE INSTALLING THE UNIT.
- E1 BASIC UNIT CLEAR OPENING EXCEEDS 20" IN WIDTH, 24" IN HEIGHT & A MINIMUM OF 5.0 SQ. FT., FOR FIRST FLOOR EGRESS.
- T BASIC UNIT IS NOT AVAILABLE WITH TRI-PANE GLASS.
- ## NUMBER INDICATES DESIGN PRESSURE (DP) RATING WITH STANDARD GLASS.
- ##* NUMBER INDICATES HIGHER DP RATING, TALLER SILL STOP AND IMPACT GLAZING.

Note: Elevations shown DO NOT have exterior trim. Subtract 1/2"(12.7) from M.O.(Masonry Opening) for Unit Sizes. Masonry openings above include Sill Nose, see Trim Options page for Sill Nose specifications. For other Trim Options refer to the Unit Sizing, Rough Opening & Masonry Openings page.

EXPOSED TILT LATCH
VERTICAL SECTION

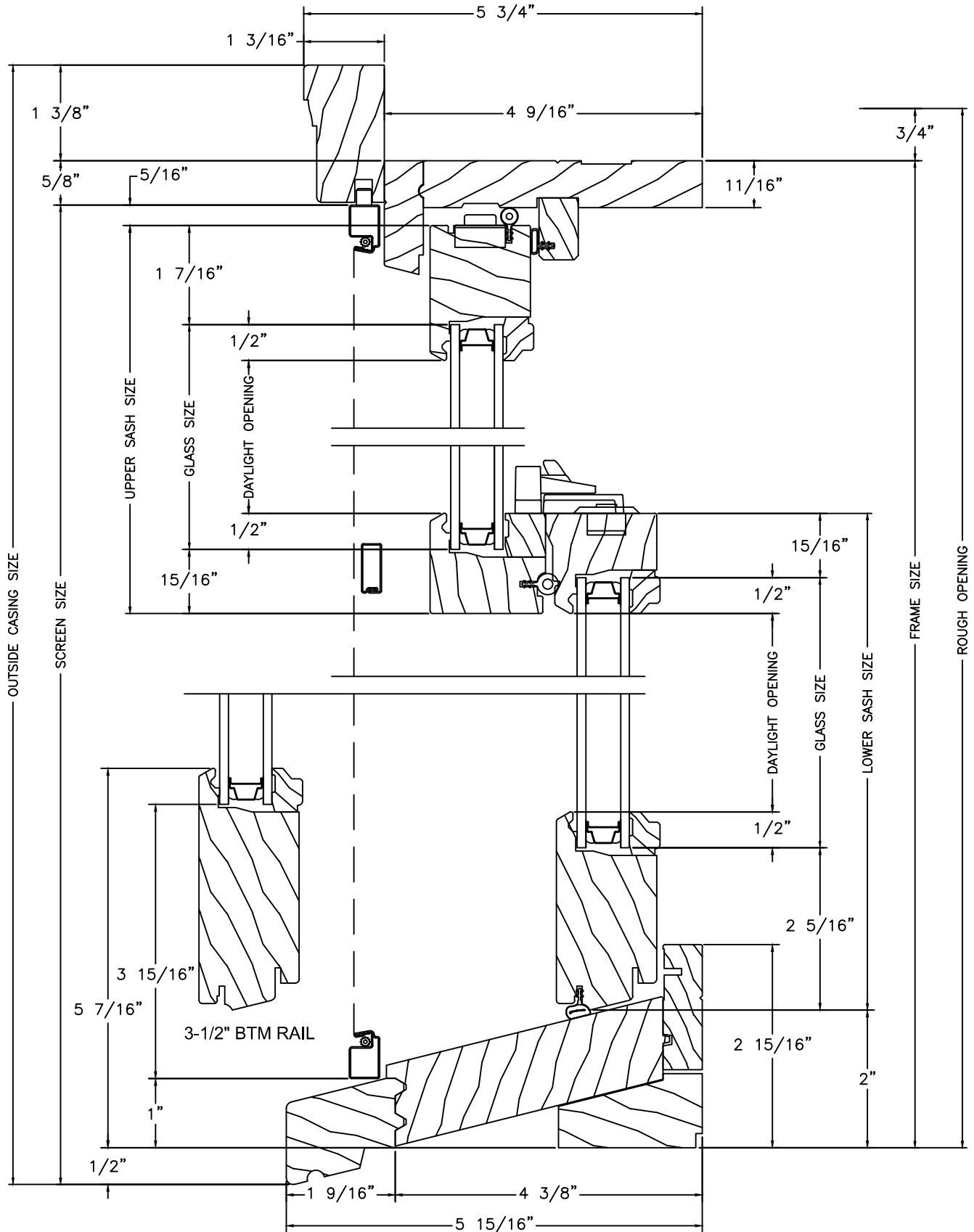

CONCEALED TILT LATCH
VERTICAL SECTION

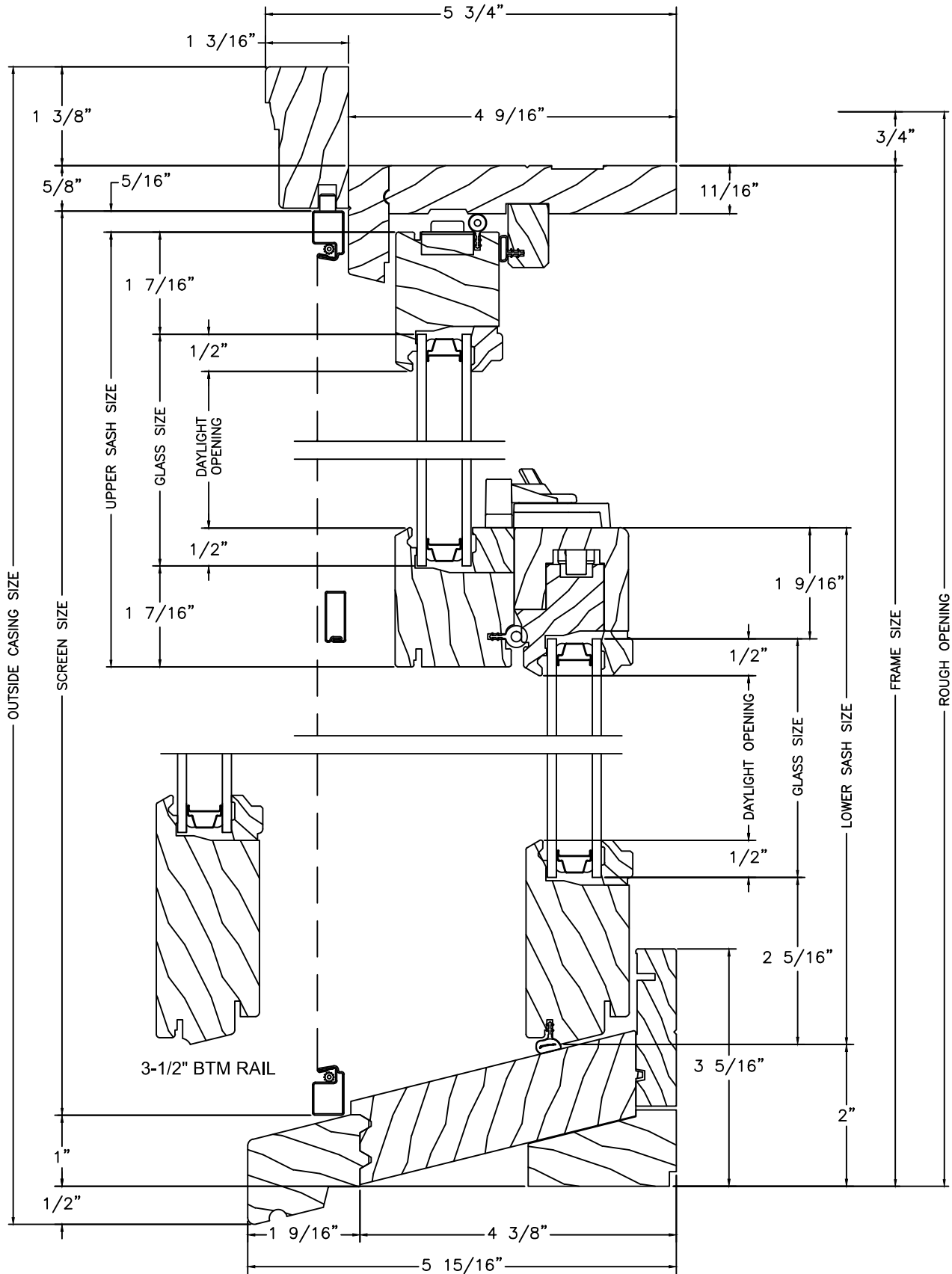

HORIZONTAL SECTION

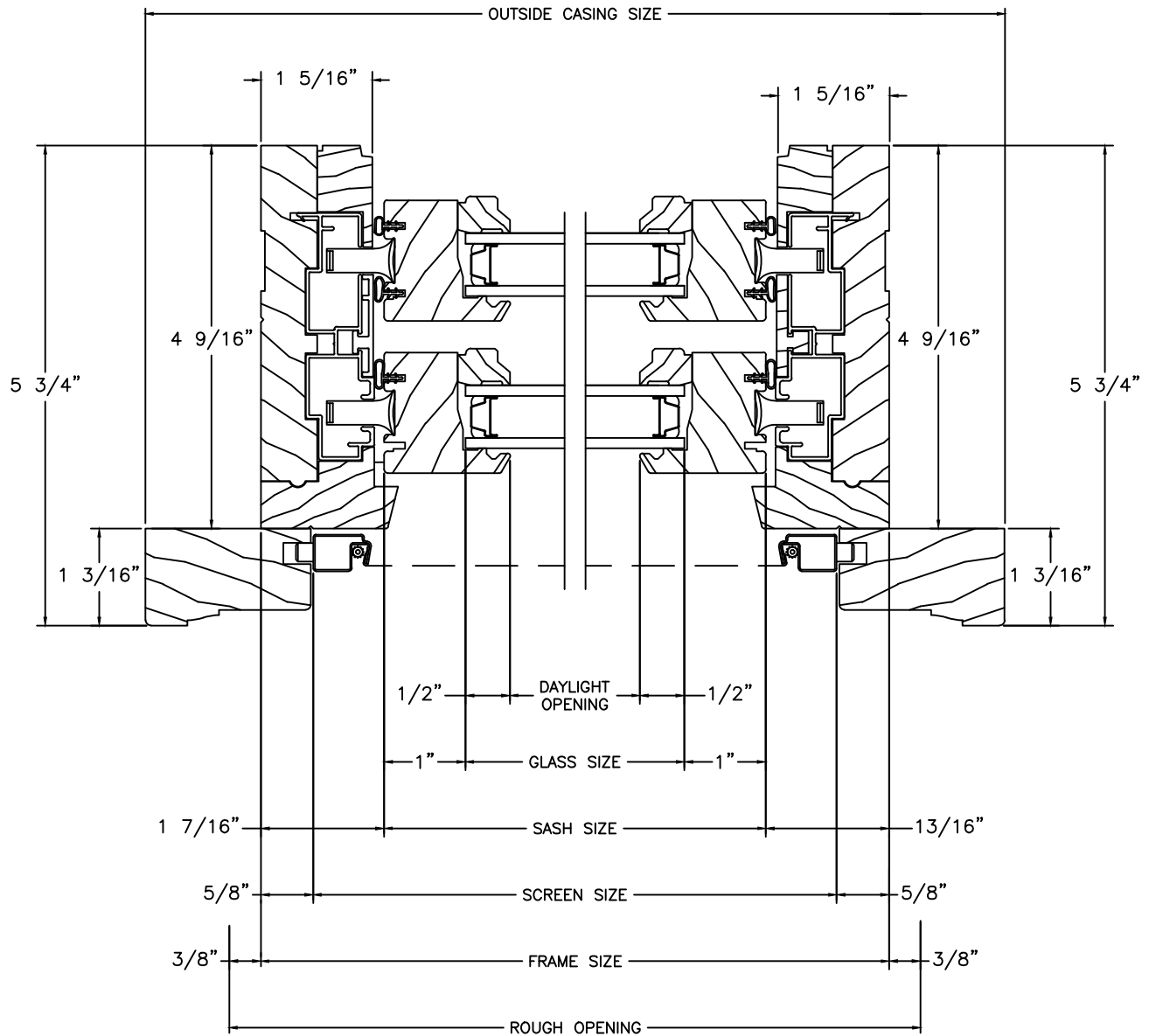

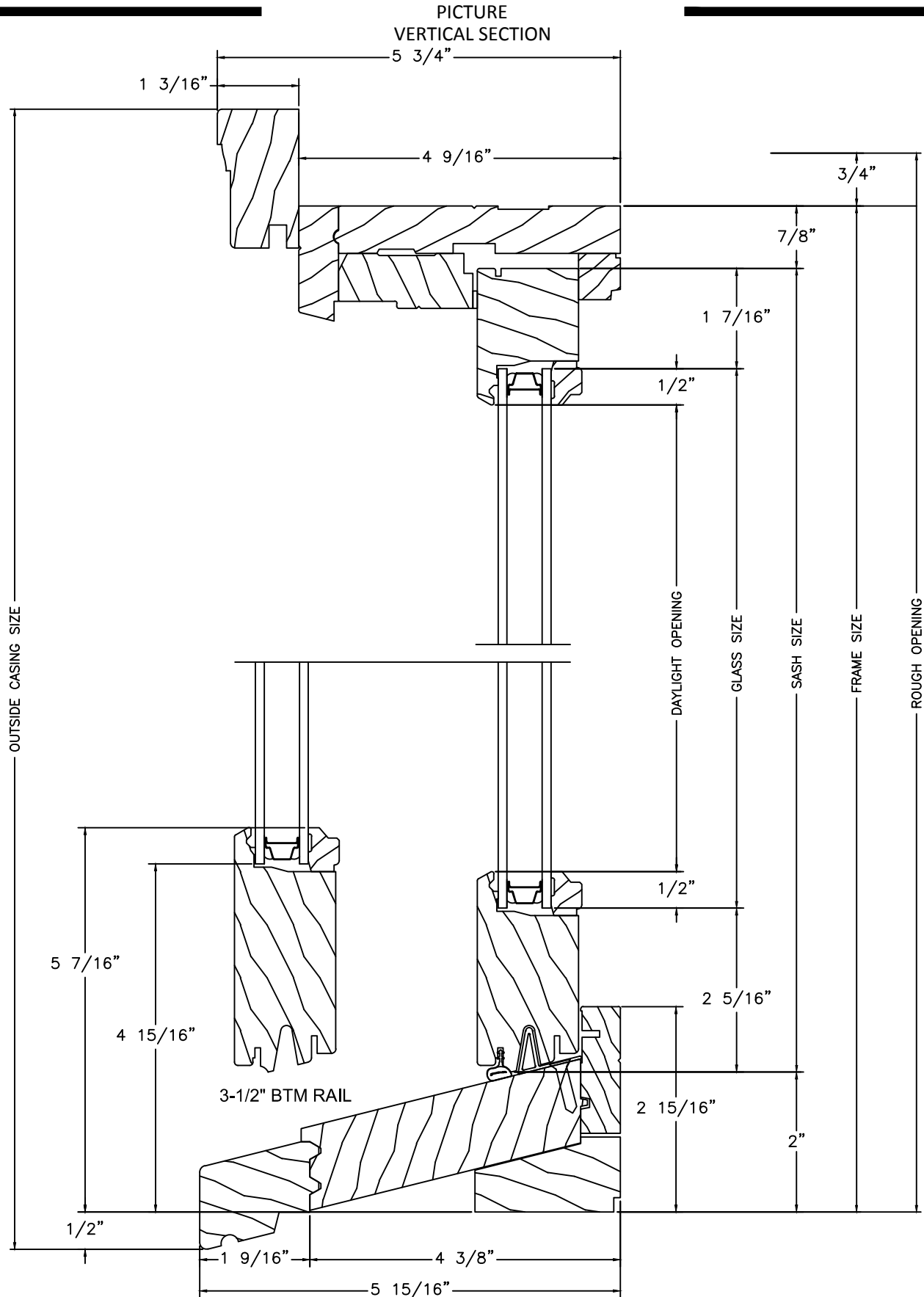

PICTURE
HORIZONTAL SECTION

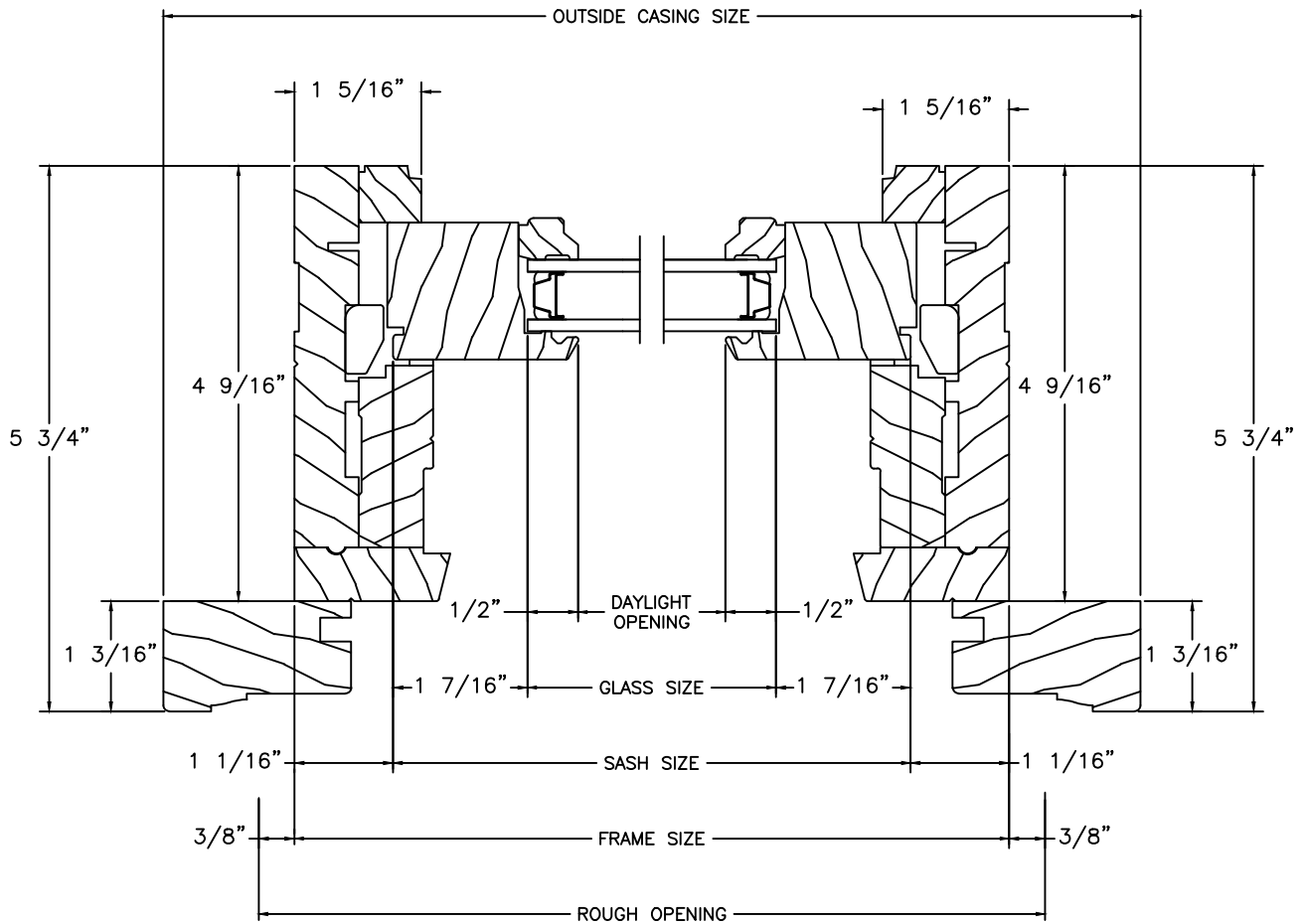

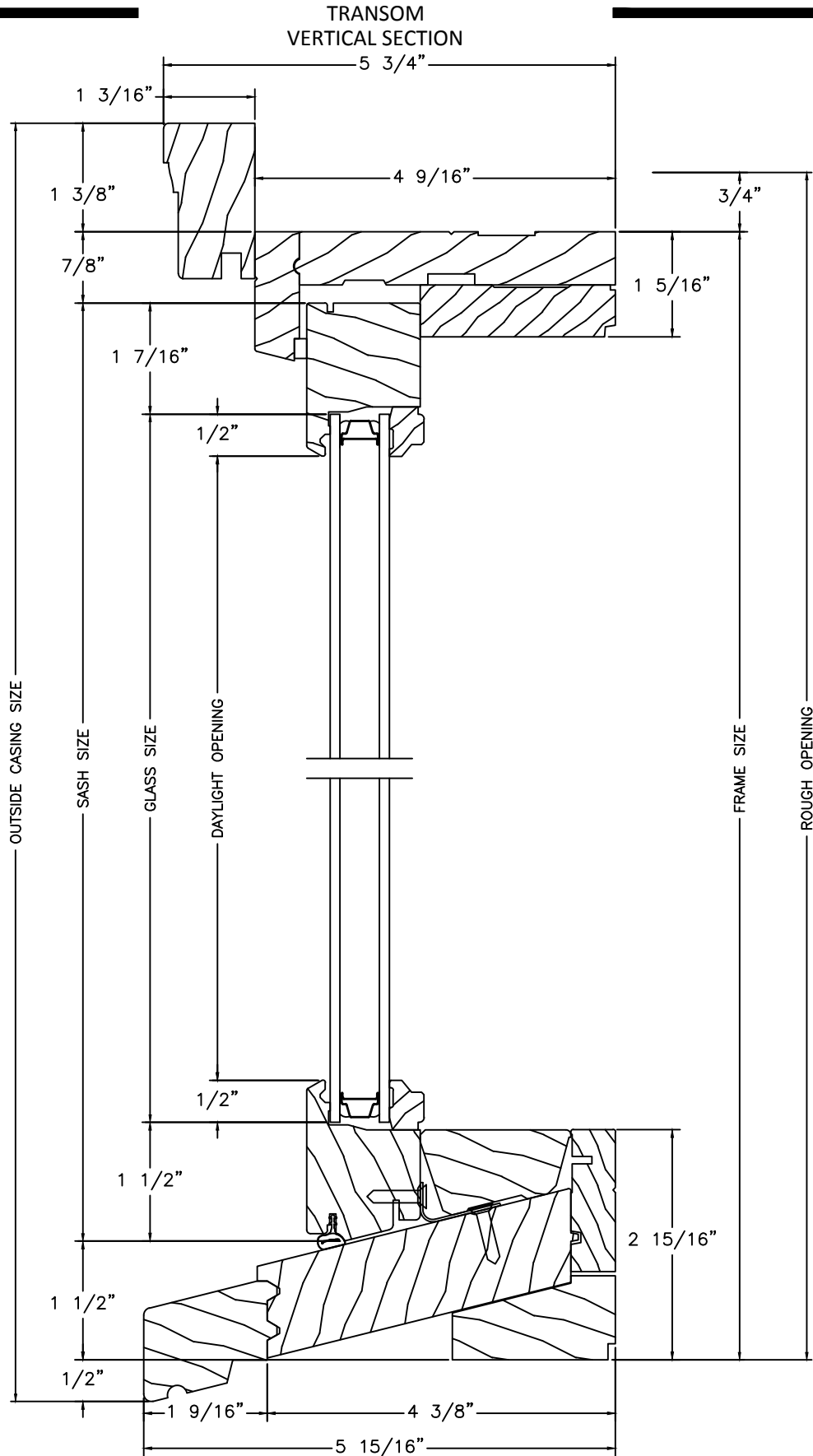

TRANSOM
HORIZONTAL SECTION

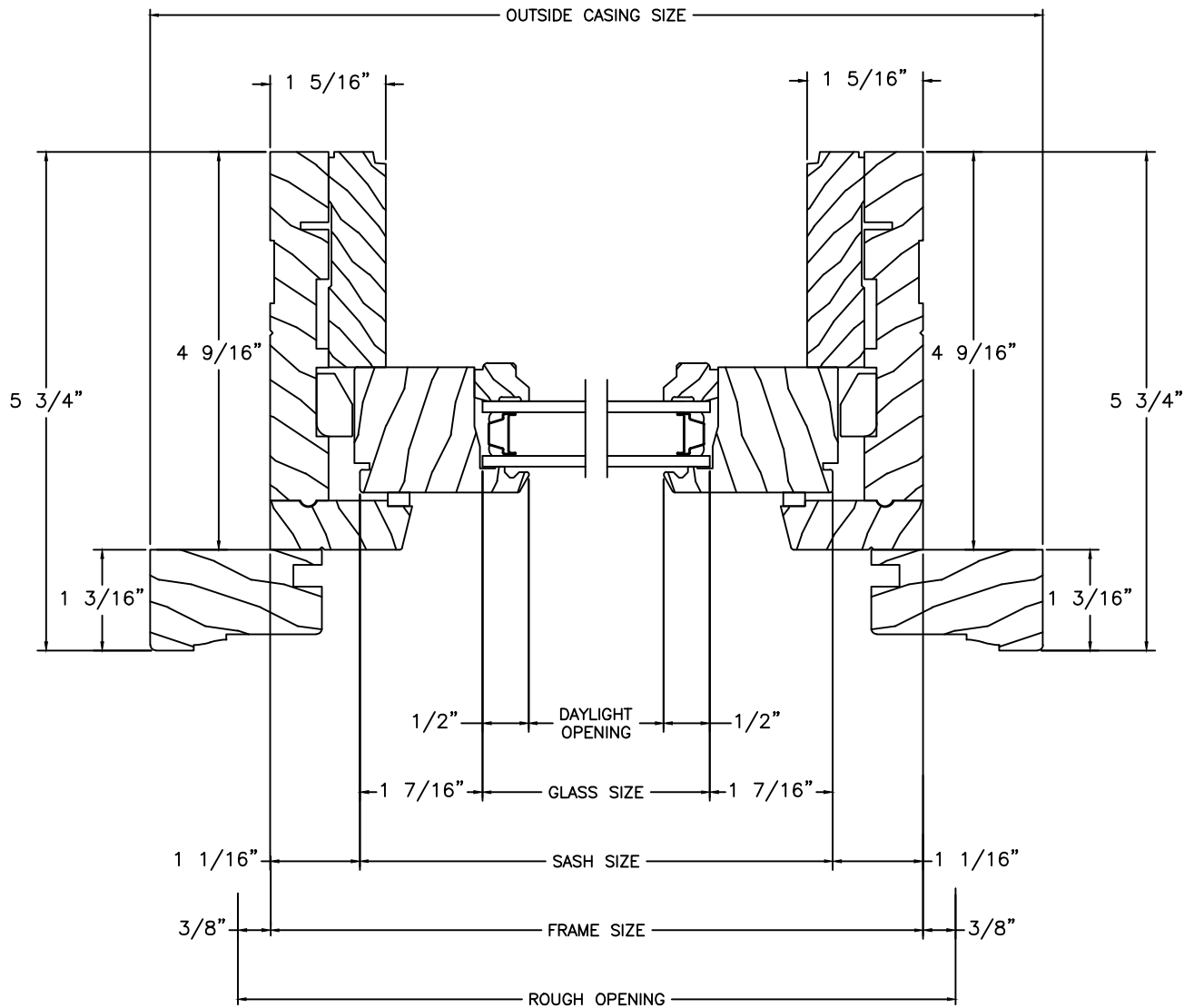

RADIUS TOP EXPOSED TILT LATCH
VERTICAL SECTION

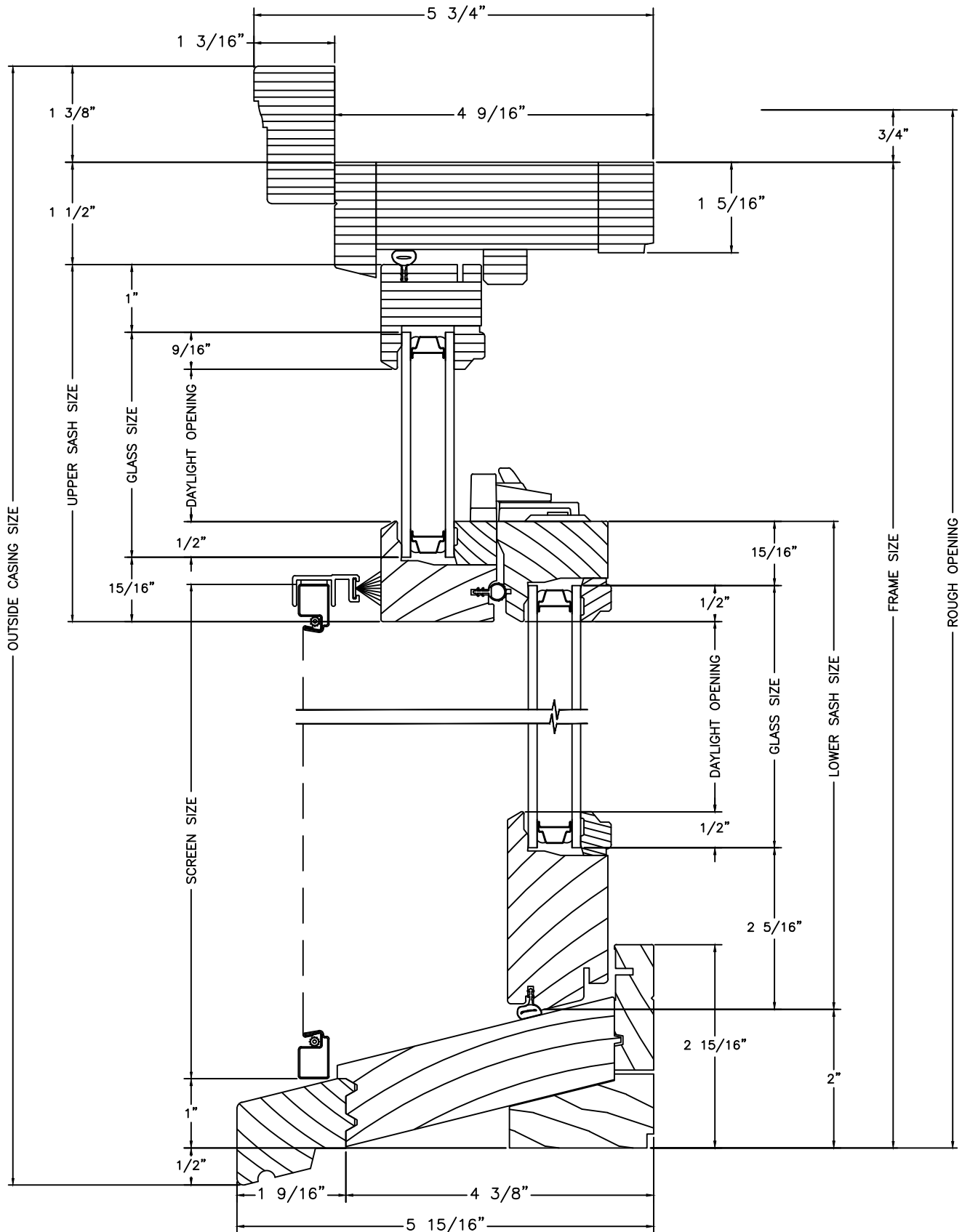

SINGLE HUNG WZ3 IMPACT
VERTICAL SECTION

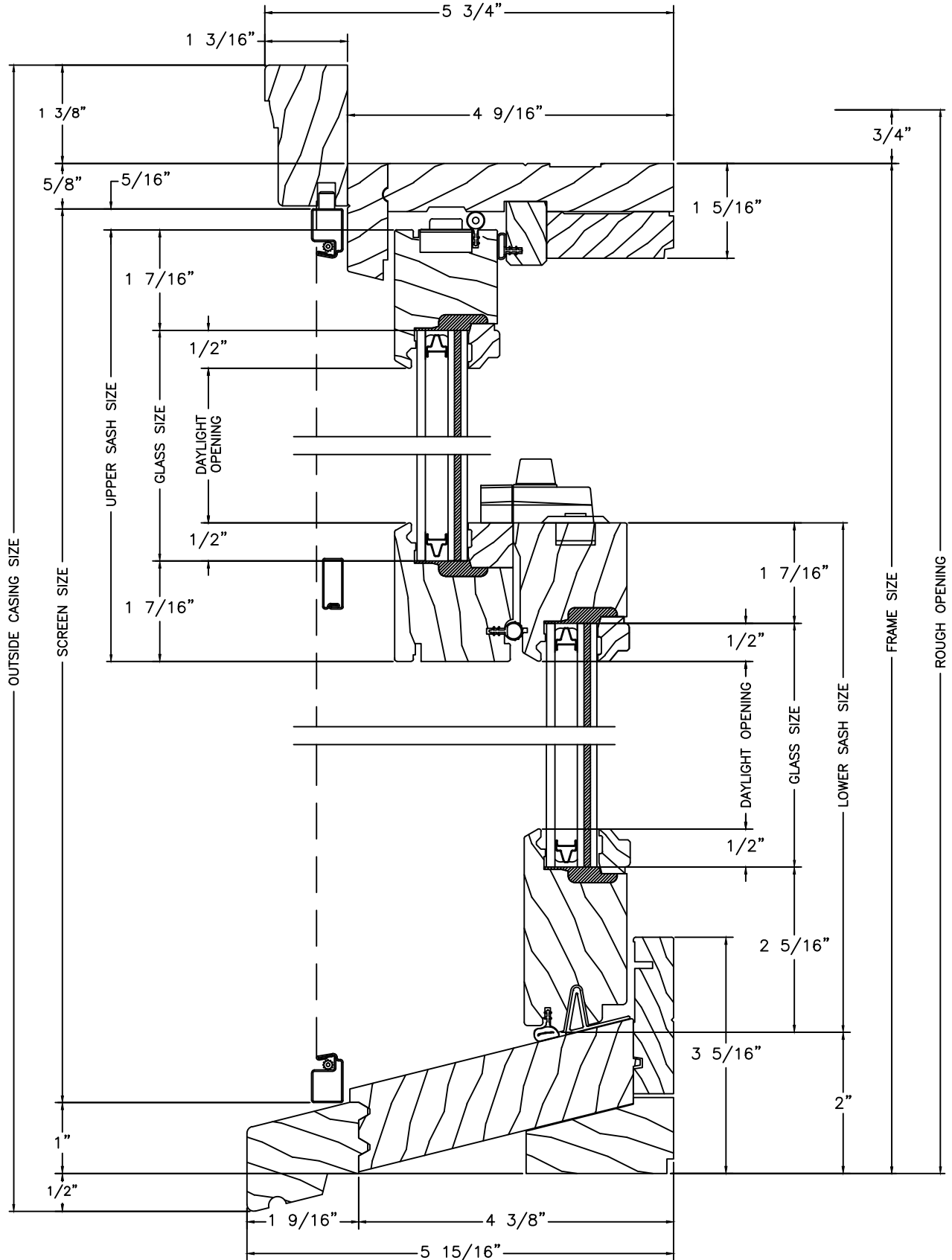

SINGLE HUNG WZ3 IMPACT
HORIZONTAL SECTION

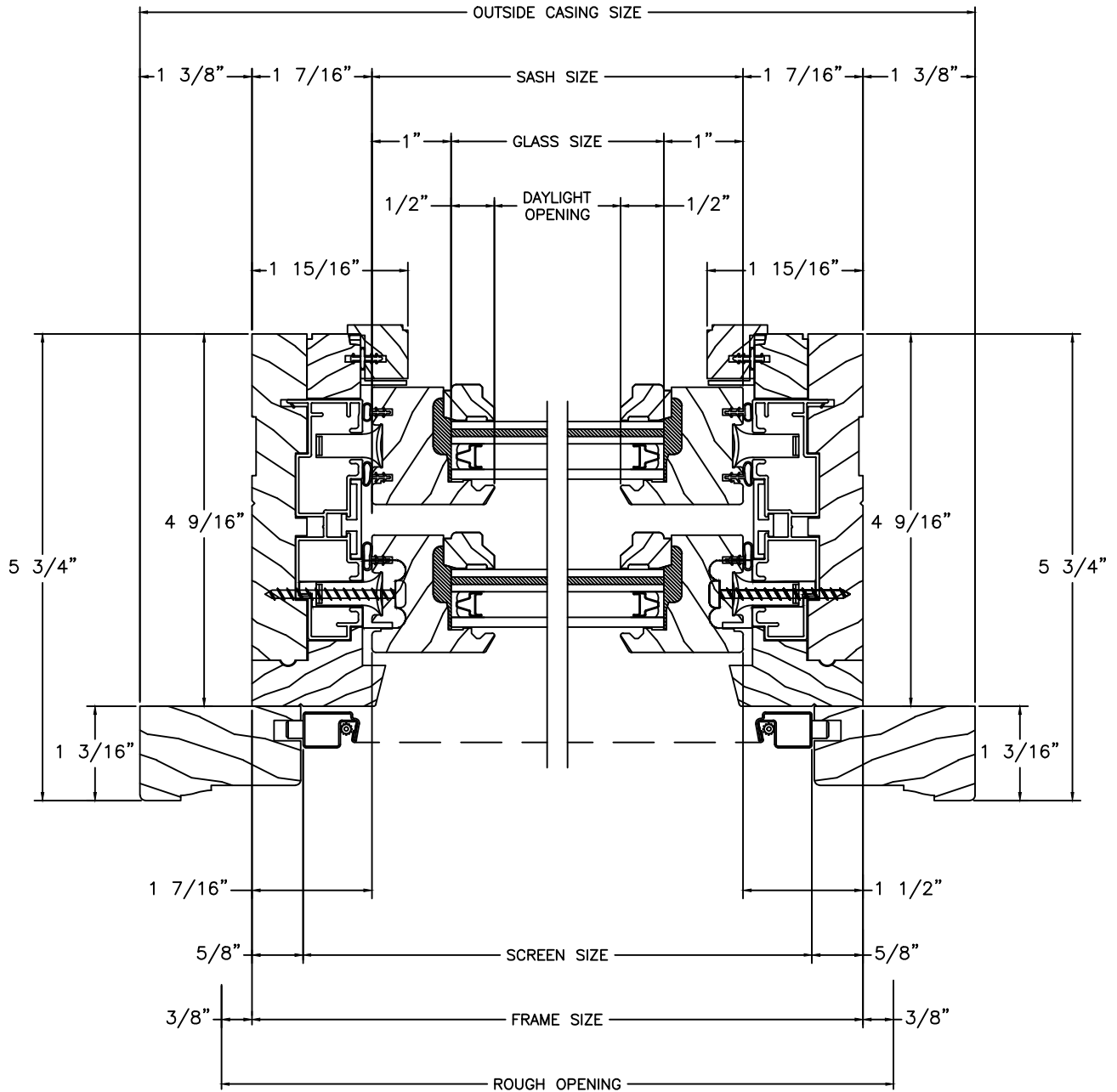

BAY
VERTICAL SECTION

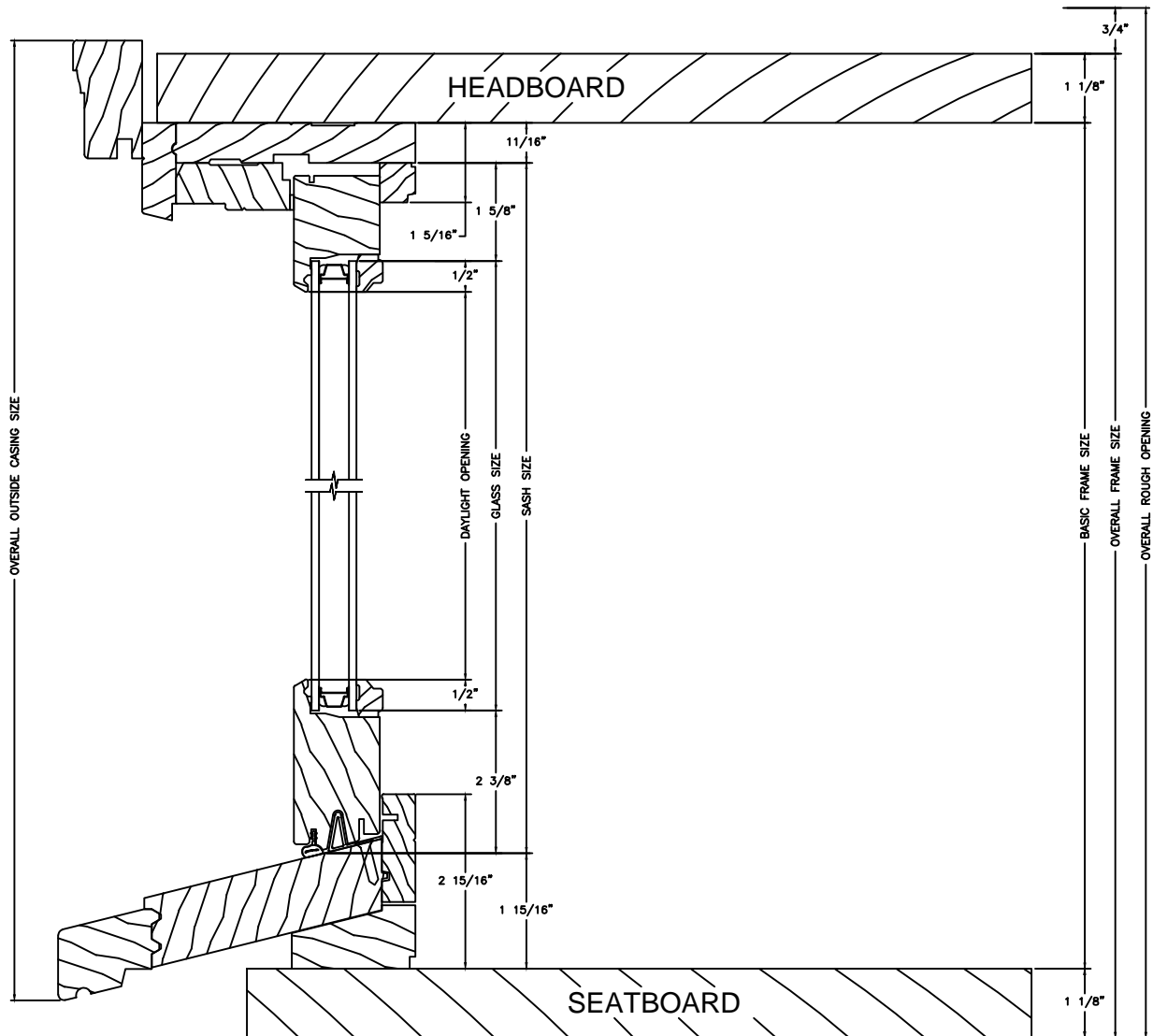

BAY - NO TRIM
VERTICAL SECTION

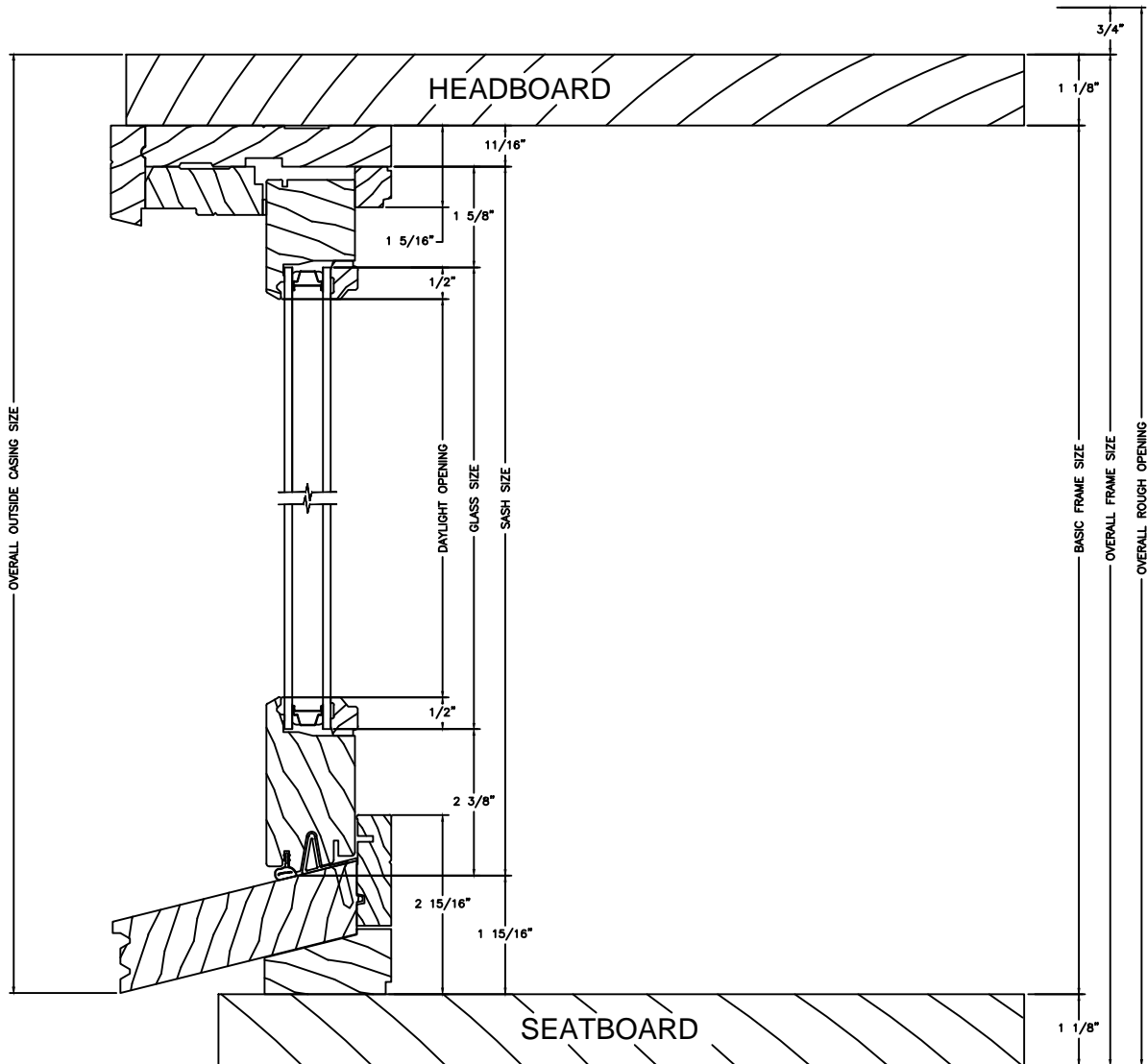

30 BAY
HORIZONTAL SECTION

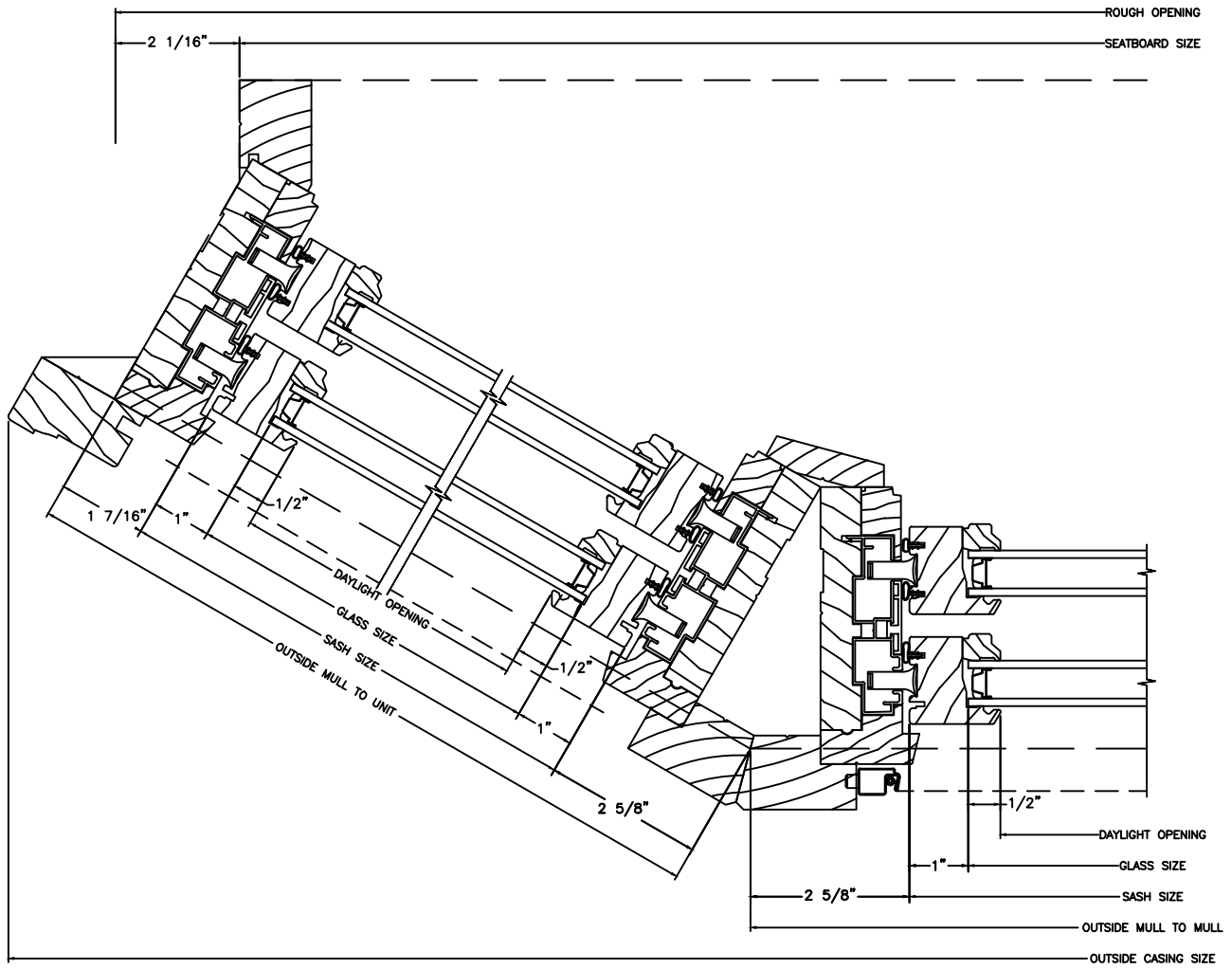

Horizontal Section

45 BAY
HORIZONTAL SECTION

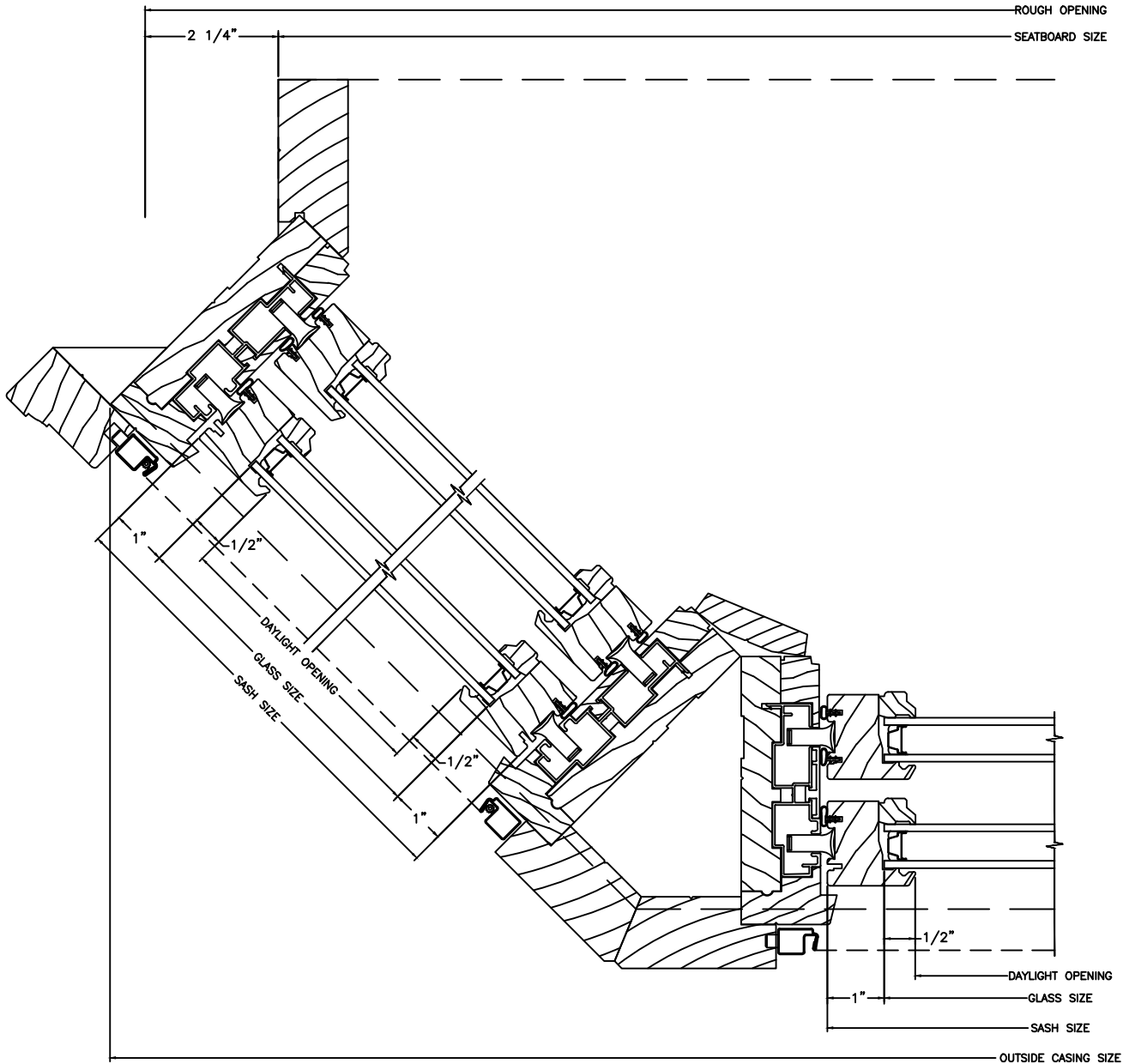

Horizontal Section