TABLE OF CONTENTS

Specifications	4-2
Quick Spec Guide	4-4
Elevations/Sizes: 1/4" & 1/8" Scale	4-6
Casement	4-9
Casement Picture	4-14
Casement Sector Top	4-23
Extended Half Round	4-25
Extended Quarter Round	4-28
Glazing Options	4-30
Trim Options	4-39
Grille & SDL Patterns	4-41
Unit Sizing, Rough Openings & Masonry Openings	4-42
Section Details: 6" Scale	4-44

PRODUCT SPECIFICATIONS**EXTERIOR FINISH**

The standard exterior is factory-applied latex primer with an option for unfinished (stain grade) natural pine exterior available.

AURALAST® WOOD

AuraLast® wood is fundamentally different from wood treated in traditional millwork preservation processes in that it uses a proprietary vacuum/pressure process to provide protection throughout the wood parts used to make windows and doors. AuraLast® wood is distinguished from wood using traditional preservation methods by its unique ability to achieve greater penetration of the active ingredients into the wood parts, with a minimum treatment penetration of 92%.

INTERIOR FINISH

Interior surfaces are unfinished clear pine ready for on-site finishing. Optional prefinished pine interiors include four acrylic colors (Moderate White, Extra White, Natural Choice, Pure White), five stains (Wheat, Cherry, Fruitwood, Cordovan, Cider) and a clear lacquer topcoat. Primed interior is also available.

FRAME

Frame is assembled from select kiln-dried pine AuraLast® wood on all exterior parts. Standard jamb width is 4-9/16".

SASH

2-3/32" thick select kiln-dried pine AuraLast® wood. Corner joints are mortised-and-tenoned, with the glass mounted into the sash using a silicone-glazing compound on the exterior and acrylic sealant on the interior, then secured with interior applied profiled wood stops. To accommodate the new nesting crank hardware, the height of the bottom rail has been increased to 2-3/32".

GLAZING

Insulating glass is constructed from two panes of glass, utilizing a continuous roll formed stainless steel spacer with dual seal sealant. The glass is mounted into the sash using a silicone-glazing compound and secured with interior applied profiled wood stops. All insulating glass units comply with the performance requirements of IGCC in accordance with either ASTM E774 or E2190.

GLAZING OPTIONS

Insulating glass available in Low-E with Argon, Low-E, Low-E 366, Clear, Neat Glass, Seedy Reamy, tinted, reflective, or obscure, tempered or other specialty glass as specified. Preserve® film is a 0.003" thick polyethylene film with a low tack acrylic adhesive applied to the glass for protection during shipping and installation. Installations at 4,000 foot elevations and higher require a capillary tube to equalize environmental stress (otherwise known as High Altitude glazing). High Altitude glazing does not allow the use of Argon as listed under glazing options.

WEATHER-STRIPPING

Engineered system combines foam lined bulb seal compressed between the interior of the sash and the frame in a continuous plane on all four sides with a secondary bulb seal compressed between the edge of the sash and the frame.

HARDWARE

Operating sash are mounted to the frame with corrosion resistant steel hinges. The operating hardware consists of hardened steel worm gears and dual action heavy gauge steel operating arms. The sash is secured with concealed type locking hardware. The interior operator cover, nesting crank handle, and locking handle standard finish options are White, Chestnut Bronze, and Desert Sand, with optional finishes in plated Polished Brass, Antique Brass, Polished Chrome, Brushed Chrome, Oil-Rubbed Bronze, Satin Nickel, and Powder Coat Black.

INTERIOR INSECT SCREENS

Charcoal fiberglass screen cloth (18x16 mesh) set in painted roll formed aluminum frame fitted to the inside of the window with all necessary hardware, in White, Chestnut Bronze or Desert Sand finishes. Wood veneer wrapped screen frames and Phantom screens are available in Ponderosa Pine. Insect screens are intended to allow air and light in and to keep insects out. They are not intended to keep anyone or anything from falling through an open window. For safety screens or other security devices contact your local building supply retailer.

GRILLES

SDL (Simulated Divided Lites) - extruded aluminum muntins permanently applied to the exterior of the insulating glass unit (not available on textured glass) in 5/8", 7/8", 1-1/8", or 1-3/8" widths. Profiles are bead stop in all widths, and a putty profile in 5/8", 7/8", and 1-1/8" widths only. 1" Copper SDL is also available. SDL is standard with a light bronze internal shadow bar to give a true divided lite appearance. As an option, SDL may be ordered with a silver shadow bar. Clear wood interior muntin bars match the exterior muntin width and are permanently bonded to the interior of the glass. Also available is a 2-5/16" SDL bar, which simulates a double-hung checkrail.

PDL (Precise Divided Lites) - Wood or extruded aluminum muntins permanently applied to the exterior of the insulating unit (not available on textured glass) in 3/4" and 1-1/2" widths without a shadow bar. Clear wood interior muntin bars match the exterior muntin width and are permanently bonded to the interior of the glass.

Full-Surround Removable Wood Grilles - Rectangular, unfinished interior clear pine wood grilles in 7/8", 1-1/8", and 1-3/8" are available in patterns selected by the owner.

GBG (Grilles between the Glass) - 5/8" (15.9mm) flat and 23/32" or 1" contour mounted between the glass panes suspended within the air cavity.

EXTERIOR TRIM

Brickmould standard with optional 3-1/2", 4-1/2", 5-1/2" flat trim, 3-1/2" Adams and 1 x 4 Backband trim. Optional mull covers to accommodate 1" (spread only), 2", 3-1/2" and 6" spread and stud pocket mull.

EXTENSION JAMBS

Extensions are applied to the interior on all four sides of the frame in wall depths up to 9-1/8" for 4/4 and up to 13-11/16" for 5/4, factory applied.

PRODUCT SPECIFICATIONS

INSTALLATION

Installation per JELD-WEN Installation Method for Wood Windows.
See www.jeld-wen.com/resources for instructions.

PERFORMANCE

NFRC Certified - (rated and labeled in accordance with NFRC 100 and 200 procedures)

ANSI/AAMA/NWDA/101/I.S.2-97
AMMA/WDMA/CSA 101/I.S.2/A440-05
WDMA Hallmark Certified

See www.jeld-wen.com for architectural and performance information.

QUICK SPEC GUIDE

SPECIFICATION	STANDARD FEATURES	OPTIONAL FEATURES <i>Some options may require additional lead times. Consult your JELD-WEN Sales Representative.</i>
EXTERIOR FINISH	<ul style="list-style-type: none"> • Primed 	<ul style="list-style-type: none"> • Natural • Vertical Grain Douglas Fir • Mahogany
		<p>Sash Only:</p> <ul style="list-style-type: none"> • Bright Copper* <i>*Copper is only available when ordered with a clad sash</i> • Speckled Patina Copper • Hand Rubbed Patina Copper (sash only)
EXTERIOR TRIM	<ul style="list-style-type: none"> • Brickmould & Subsill 	<ul style="list-style-type: none"> • Adams Casing • 3-1/2" Flat Casing • 4-1/2" Flat Casing • 5-1/2" Flat Casing • Extended Sill Nose • 1x4 Backband
INTERIOR WOOD	<ul style="list-style-type: none"> • Western Pine 	<ul style="list-style-type: none"> • Vertical Grain Douglas Fir • Mahogany
INTERIOR FINISH	<ul style="list-style-type: none"> • Natural 	<ul style="list-style-type: none"> • Priming Available Pre-finished Interior Options are: <ul style="list-style-type: none"> • Paint - Pure White, Extra White, Natural Choice, Moderate White • Stain - Wheat, Fruitwood, Cherry, Cordovan, Cider • Clear Lacquer
SIZE	<ul style="list-style-type: none"> • Width: 18, 20, 24, 28, 30, 32, 36 • Height: 18, 20, 24, 30, 32, 36, 40, 42, 48, 54, 56, 60, 64, 66, 72, 78, 84 	<ul style="list-style-type: none"> • Any Width: 16 to 36 • Any Height: 16 to 84
GLAZING	<ul style="list-style-type: none"> • Low-E Insulating Glass (with Argon) • Low-E 366 • Preserve® Protective Film 	<ul style="list-style-type: none"> • Clear • Obscure • Reflective • Tints: Bronze, Gray, Green • Glue Chip • Safety Laminate in Clear, Bronze or Gray • Rain • Neat Glass • Seedy Reamy • Narrow Reed • Sandblasted • Tempered • Impact Resistant
		<ul style="list-style-type: none"> • High Altitude (Breather Tube, no Argon)
GRILLES		<p>SDL Bead Profile:</p> <ul style="list-style-type: none"> • 5/8", 7/8", 1-1/8", 1-3/8", 2-5/16" with Light Bronze Shadow Bar • 5/8", 7/8", 1-1/8", 1-3/8", 2-5/16" with Silver Shadow Bar <p>SDL Putty Profile:</p> <ul style="list-style-type: none"> • 5/8", 7/8" and 1-1/8" with Light Bronze Shadow Bar • 5/8", 7/8" and 1-1/8" with Silver Shadow Bar <ul style="list-style-type: none"> • 1" Copper SDL <p>PDL:</p> <ul style="list-style-type: none"> • 3/4" or 1-1/2" Precise Divided Lite <p>GBG (Grilles between the Glass):</p> <ul style="list-style-type: none"> • 5/8" Flat, 23/32" Contour, 1" Contour <p>Full-Surround:</p> <ul style="list-style-type: none"> • 7/8", 1-1/8", 1-3/8"

Continued on next page

QUICK SPEC GUIDE

SPECIFICATION	STANDARD FEATURES	OPTIONAL FEATURES <i>Some options may require additional lead times. Consult your JELD-WEN Sales Representative.</i>
HARDWARE	<ul style="list-style-type: none"> • Nesting Handle • Concealed Locking System 	<ul style="list-style-type: none"> • Round Knob
HARDWARE COLOR	<ul style="list-style-type: none"> • White • Chestnut Bronze • Desert Sand 	<ul style="list-style-type: none"> <li style="width: 50%;">• Polished Brass <li style="width: 50%;">• Brushed Chrome <li style="width: 50%;">• Antique Brass <li style="width: 50%;">• Oil-Rubbed Bronze <li style="width: 50%;">• Polished Chrome
JAMB	<ul style="list-style-type: none"> • Applied, 5/4 • 4-9/16" 	<ul style="list-style-type: none"> • Up to 9-1/8" 4/4 • Up to 13-11/16" 5/4
INSECT SCREENS	<ul style="list-style-type: none"> • Fiberglass 	<ul style="list-style-type: none"> • Phantom Screen and wood veneer wrapped screens available in Pine, Vertical Grain, Knotty Alder, and Mahogany
SCREEN FRAME COLOR	<ul style="list-style-type: none"> • White • Chestnut Bronze • Desert Sand 	Wood Veneer (Interior) <ul style="list-style-type: none"> • Ponderosa Pine • Vertical Grain Douglas Fir • Mahogany • Knotty Alder

GENERAL INFORMATION
CASEMENT

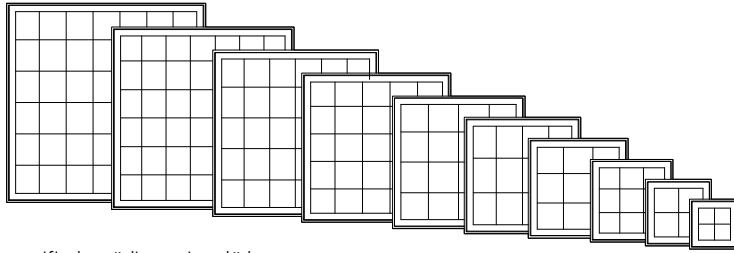

DIMENSIONAL WINDOWS

Wood Epic casement windows may be specified as "dimensional" by adjusting the desired rough opening width or height in 1/4" increments from standard.

Wood Epic casement windows are available with left or right hand operation, or stationary (non-venting). Operating mechanism includes corrosion resistant steel hinges and dual arm roto-type operator with hardened steel gears and operating arms. Sash locks are concealed unison type with an exposed locking lever and escutcheon plate. There are several interior hardware finish options. Refer to the Specifications for finish options.

MULTIPLE ASSEMBLIES

Wood Epic casement windows may be mullied above, below, or beside other wood casement windows, or other wood window products. Factory assembled mulls are limited in height (100"), width (150"), and a total area of 75 square feet.

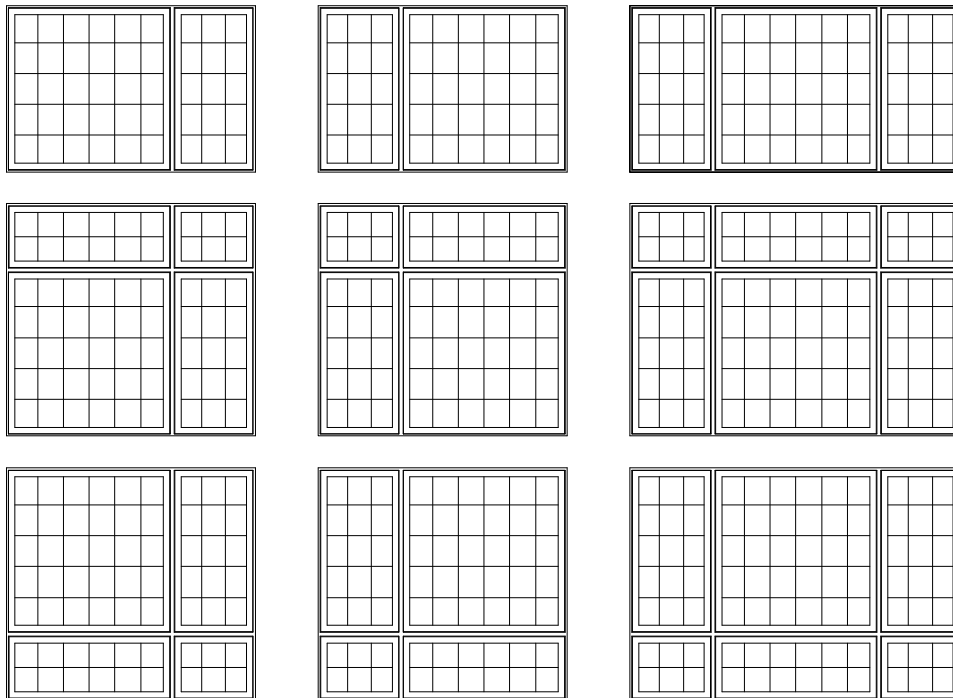

**HANDING & OPERATION
CASEMENT**

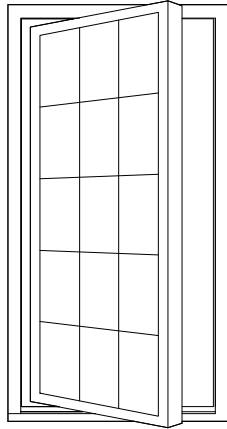

**LEFT
HAND**

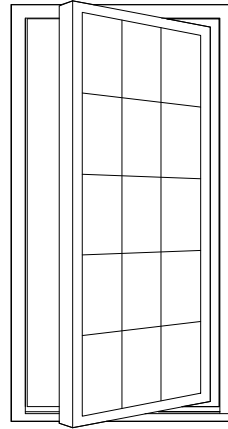

**RIGHT
HAND**

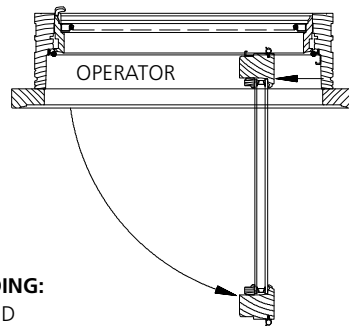
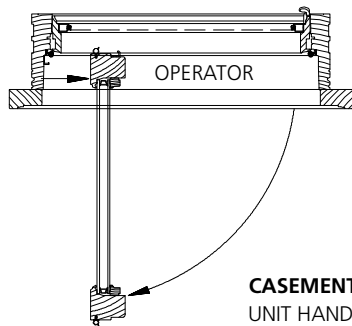

CASEMENT UNIT HANDING:
UNIT HANDING IS DEFINED
(FROM THE EXTERIOR) AS THE
DIRECTION THE SASH OPENS.

ELEVATION NOTES
CASEMENT

ELEVATION DRAWINGS UTILIZE A LIMITED NUMBER OF PROJECTED LINES TO PRODUCE A RUDIMENTARY DRAWING INTENDED TO BE USED IN A SMALL GRAPHICAL SCALE. ELEVATIONS ARE VIEWED PERPENDICULAR FROM THE EXTERIOR OF THE STRUCTURE. IF MORE DIMENSIONS ARE NEEDED, USE THE SECTION DRAWINGS FOR MORE COMPLETE DEPICTIONS.

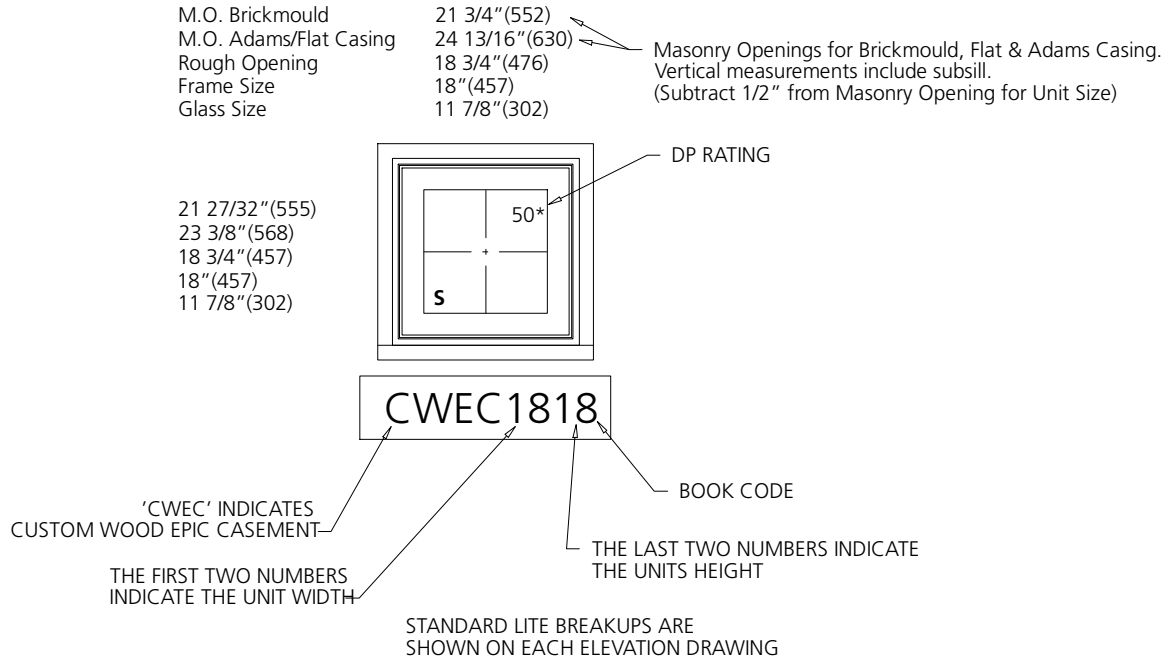

GENERAL CASEMENT NOTES

- WOOD EPIC CASEMENT (WEC) UNITS ARE AVAILABLE AS OPERATING OR FIXED UNITS.
- 'WCEP' IN A BOOK CODE DENOTES THE UNIT IS A WOOD EPIC CASEMENT PICTURE (FIXED) UNIT.
- UNIT ELEVATIONS ARE SHOWN WITH BRICKMOULD AND SUBSILL.
- ELEVATION DRAWINGS SHOW STANDARD LIGHT CUTS FOR 7/8" [22] OR 1 1/8" [29] GRILLE BARS OR SIMULATED DIVIDED LITE.
- OPERATING UNITS ARE AVAILABLE AS LEFT OR RIGHT HAND OPERATION.
- DIMENSIONAL VALUES IN () ARE MILLIMETER CONVERSIONS.

ELEVATION SYMBOL LEGEND:

- E** UNIT MEETS EGRESS REQUIREMENTS FOR IRC CODE. STATE AND LOCAL EGRESS CODES MAY DIFFER. ALWAYS REFER TO LOCAL BUILDING CODES FOR COMPLETE REQUIREMENTS. CHECK WITH LOCAL OFFICIALS TO ENSURE COMPLIANCE BEFORE INSTALLING THE UNIT.
- S** STATIONARY UNIT.
- ##*** NUMBER INDICATES DESIGN PRESSURE (DP) RATING WITH STANDARD GLAZING. OPERATING UNITS UTILIZE THE R65 LOCKING SYSTEM FOR DP RATINGS.

1-WIDE UNITS

M.O. BRICKMOUND	21 3/4" (552)	23 3/4" (603)	27 3/4" (705)	31 3/4" (806)	33 3/4" (857)	35 3/4" (908)	39 3/4" (1010)
M.O. ADAMS/FLAT CASING	24 13/16" (630)	26 13/16" (681)	30 13/16" (783)	34 13/16" (884)	36 13/16" (935)	38 13/16" (986)	42 13/16" (1087)
ROUGH OPENING	18 3/4" (476)	20 3/4" (527)	24 3/4" (629)	28 3/4" (730)	30 3/4" (781)	32 3/4" (832)	36 3/4" (933)
FRAME SIZE	18" (457)	20" (508)	24" (610)	28" (711)	30" (762)	32" (813)	36" (914)
DAYLIGHT OPENING	11 7/8" (302)	13 7/8" (352)	17 7/8" (454)	21 7/8" (556)	23 7/8" (607)	25 7/8" (657)	29 7/8" (759)
17 27/32" (453) 19 3/8" (492) 14 3/4" (375) 14" (356) 7 7/8" (200)							
21 27/32" (555) 23 3/8" (568) 18 3/4" (476) 18" (457) 11 7/8" (302)							
23 27/32" (606) 25 3/8" (645) 20 3/4" (527) 20" (508) 13 7/8" (352)							
27 27/32" (707) 29 3/8" (746) 24 3/4" (629) 24" (610) 17 7/8" (454)							
33 27/32" (860) 35 3/8" (899) 30 3/4" (781) 30" (762) 23 7/8" (607)							
35 27/32" (910) 37 3/8" (949) 32 3/4" (832) 32" (813) 25 7/8" (657)							
39 27/32" (1012) 41 3/8" (1051) 36 3/4" (933) 36" (914) 29 7/8" (759)							
43 27/32" (1114) 45 3/8" (1153) 40 3/4" (1035) 40" (1016) 33 7/8" (860)							
45 27/32" (1164) 47 3/8" (1203) 42 3/4" (1086) 42" (1067) 35 7/8" (911)							

ELEVATION SYMBOL LEGEND:

M.O. = MASONRY OPENING

VALUES IN () ARE IN MILLIMETER CONVERSIONS.

##* NUMBER INDICATES DESIGN PRESSURE (DP) RATING WITH STANDARD GLAZING.

E UNIT MEETS EGRESS REQUIREMENTS FOR IRC CODE. STATE AND LOCAL EGRESS CODES MAY DIFFER. ALWAYS REFER TO LOCAL BUILDING CODES FOR COMPLETE REQUIREMENTS. CHECK WITH LOCAL OFFICIALS TO ENSURE COMPLIANCE BEFORE INSTALLING THE UNIT.

S STATIONARY UNIT.

Note: Elevations shown DO NOT have exterior trim. Subtract 3/4" (19) from M.O. (Masonry Opening) for Unit Sizes. Masonry Openings above include Sill Nose, see Trim Options page for Sill Nose specifications. For other Trim Options refer to the Unit Sizing, Rough Opening & Masonry Openings page.

SCALE: 1/4" = 1'

1-WIDE UNITS

M.O. BRICKMOULD
M.O. ADAMS/FLAT CASING
ROUGH OPENING
FRAME SIZE
DAYLIGHT OPENING

21 3/4" (552) 24 13/16" (630) 18 3/4" (476) 18" (457) 11 7/8" (302)	23 3/4" (603) 26 13/16" (681) 20 3/4" (527) 20" (508) 13 7/8" (352)	27 3/4" (705) 30 13/16" (783) 24 3/4" (629) 24" (610) 17 7/8" (454)	31 3/4" (806) 34 13/16" (884) 28 3/4" (730) 28" (711) 21 7/8" (556)	33 3/4" (857) 36 13/16" (935) 30 3/4" (781) 30" (762) 23 7/8" (607)	35 3/4" (908) 38 13/16" (986) 32 3/4" (832) 32" (813) 25 7/8" (657)	39 3/4" (1010) 42 13/16" (1087) 36 3/4" (933) 36" (914) 29 7/8" (759)
51 27/32" (1317) 53 3/8" (1356) 48 3/4" (1238) 48" (1219) 41 7/8" (1064)						
CWEC1848	CWEC2048	CWEC2448	CWEC2848	CWEC3048	CWEC3248	CWEC3648
57 27/32" (1469) 59 3/8" (1508) 54 3/4" (1391) 54" (1372) 47 7/8" (1216)						
CWEC1854	CWEC2054	CWEC2454	CWEC2854	CWEC3054	CWEC3254	CWEC3654
59 27/32" (1520) 61 3/8" (1559) 56 3/4" (1441) 56" (1422) 49 7/8" (1267)						
CWEC1856	CWEC2056	CWEC2456	CWEC2856	CWEC3056	CWEC3256	CWEC3656
63 27/32" (1622) 65 3/8" (1660) 60 3/4" (1543) 60" (1524) 53 7/8" (1368)						
CWEC1860	CWEC2060	CWEC2460	CWEC2860	CWEC3060	CWEC3260	CWEC3660
67 27/32" (1723) 69 3/8" (1762) 64 3/4" (1645) 64" (1626) 57 7/8" (1470)						
CWEC1864	CWEC2064	CWEC2464	CWEC2864	CWEC3064	CWEC3264	CWEC3664

ELEVATION SYMBOL LEGEND:

M.O. = MASONRY OPENING
VALUES IN () ARE IN MILLIMETER CONVERSIONS.

##* NUMBER INDICATES DESIGN PRESSURE (DP) RATING WITH STANDARD GLAZING.

E UNIT MEETS EGRESS REQUIREMENTS FOR IRC CODE. STATE AND LOCAL EGRESS CODES MAY DIFFER. ALWAYS REFER TO LOCAL BUILDING CODES FOR COMPLETE REQUIREMENTS. CHECK WITH LOCAL OFFICIALS TO ENSURE COMPLIANCE BEFORE INSTALLING THE UNIT.

Note: Elevations shown DO NOT have exterior trim. Subtract 3/4" (19) from M.O. (Masonry Opening) for Unit Sizes. Masonry Openings above include Sill Nose, see Trim Options page for Sill Nose specifications. For other Trim Options refer to the Unit Sizing, Rough Opening & Masonry Openings page.

SCALE: 1/4" = 1'

1-WIDE UNITS

	M.O. BRICKMOULD	21 3/4" (552)	23 3/4" (603)	27 3/4" (705)	31 3/4" (806)	33 3/4" (857)	35 3/4" (908)	39 3/4" (1010)
	M.O. ADAMS/FLAT CASING	24 13/16" (630)	26 13/16" (681)	30 13/16" (783)	34 13/16" (884)	36 13/16" (935)	38 13/16" (986)	42 13/16" (1087)
	ROUGH OPENING	18 3/4" (476)	20 3/4" (527)	24 3/4" (629)	28 3/4" (730)	30 3/4" (781)	32 3/4" (832)	36 3/4" (933)
	FRAME SIZE	18" (457)	20" (508)	24" (610)	28" (711)	30" (762)	32" (813)	36" (914)
	DAYLIGHT OPENING	11 7/8" (302)	13 7/8" (352)	17 7/8" (454)	21 7/8" (556)	23 7/8" (607)	25 7/8" (657)	29 7/8" (759)
69 27/32" (1774) 71 3/8" (1813) 66 3/4" (1695) 66" (1676) 59 7/8" (1581)								
		CWEC1866	CWEC2066	CWEC2466	CWEC2866	CWEC3066	CWEC3266	CWEC3666
75 27/32" (1926) 77 3/8" (1965) 72 3/4" (1848) 72" (1829) 65 7/8" (1673)								
		CWEC1872	CWEC2072	CWEC2472	CWEC2872	CWEC3072	CWEC3272	CWEC3672
81 27/32" (2079) 83 3/8" (2118) 78 3/4" (2000) 78" (1981) 71 7/8" (1826)								
		CWEC1878	CWEC2078	CWEC2478	CWEC2878	CWEC3078	CWEC3278	CWEC3678
87 27/32" (2231) 89 3/8" (2270) 84 3/4" (2153) 84" (2134) 77 7/8" (1978)								
		CWEC1884	CWEC2084	CWEC2484	CWEC2884	CWEC3084	CWEC3284	CWEC3684

ELEVATION SYMBOL LEGEND:

M.O. = MASONRY OPENING

VALUES IN () ARE IN MILLIMETER CONVERSIONS.

NUMBER INDICATES DESIGN PRESSURE (DP) RATING WITH STANDARD GLAZING.

E UNIT MEETS EGRESS REQUIREMENTS FOR IRC CODE. STATE AND LOCAL EGRESS CODES MAY DIFFER. ALWAYS REFER TO LOCAL BUILDING CODES FOR COMPLETE REQUIREMENTS. CHECK WITH LOCAL OFFICIALS TO ENSURE COMPLIANCE BEFORE INSTALLING THE UNIT.

Note: Elevations shown DO NOT have exterior trim. Subtract 3/4" (19) from M.O. (Masonry Opening) for Unit Sizes. Masonry Openings above include Sill Nose, see Trim Options page for Sill Nose specifications. For other Trim Options refer to the Unit Sizing, Rough Opening & Masonry Openings page.

SCALE: 1/4" = 1'

GENERAL INFORMATION
STATIONARY CASEMENT

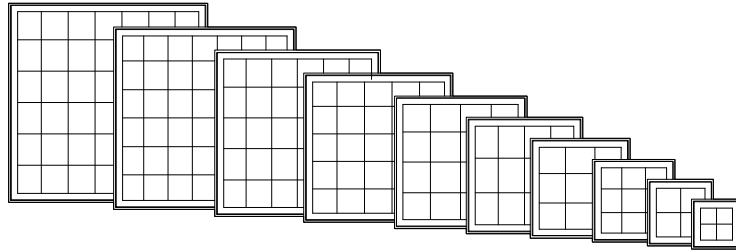

DIMENSIONAL WINDOWS

Wood Epic casement stationary windows may be specified as "dimensional" by adjusting the desired rough opening width or height in 1/4" increments from standard.

MULTIPLE ASSEMBLIES

Wood Epic casement stationary windows may be mullered above, below, or beside other wood casement windows, or other wood window products. Factory assembled mulls are limited in height (100"), width (150"), and a total area of 75 square feet.

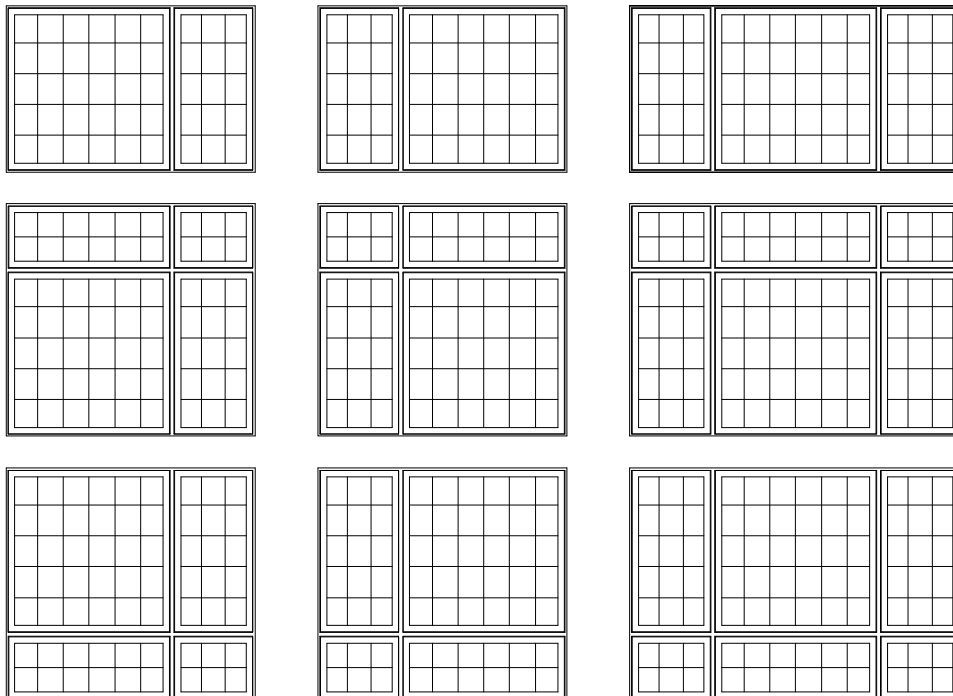

SCALE: 1/4" = 1'

ELEVATION NOTES
STATIONARY CASEMENT

ELEVATION DRAWINGS UTILIZE A LIMITED NUMBER OF PROJECTED LINES TO PRODUCE A RUDIMENTARY DRAWING INTENDED TO BE USED IN A SMALL GRAPHICAL SCALE. ELEVATIONS ARE VIEWED PERPENDICULAR FROM THE EXTERIOR OF THE STRUCTURE. IF MORE DIMENSIONS ARE NEEDED, USE THE SECTION DRAWINGS FOR MORE COMPLETE DEPICTIONS.

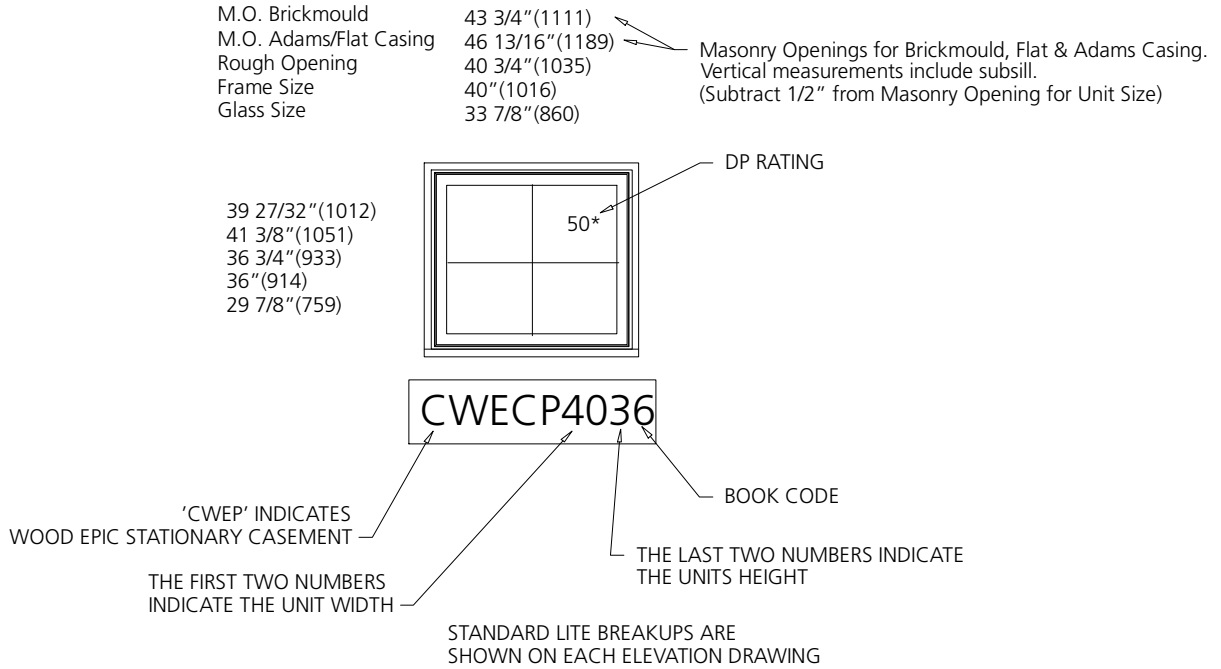

GENERAL CASEMENT NOTES

1. WOOD EPIC CASEMENT (CWEC) UNITS ARE AVAILABLE AS OPERATING OR FIXED UNITS.
2. 'CWECP' IN A BOOK CODE DENOTES THE UNIT IS A WOOD EPIC CASEMENT PICTURE (FIXED) UNIT.
3. UNIT ELEVATIONS ARE SHOWN WITH BRICKMOULD AND SUBSILL.
4. ELEVATION DRAWINGS SHOW STANDARD LIGHT CUTS FOR 7/8" [22] OR 1 1/8" [29] GRILLE BARS OR SIMULATED DIVIDED LITE.
5. OPERATING UNITS ARE AVAILABLE AS LEFT OR RIGHT HAND OPERATION.
6. DIMENSIONAL VALUES IN () ARE MILLIMETER CONVERSIONS.

ELEVATION SYMBOL LEGEND:

##* NUMBER INDICATES DESIGN PRESSURE (DP) RATING WITH STANDARD GLAZING. OPERATING UNITS UTILIZE THE R65 LOCKING SYSTEM FOR DP RATINGS.

SCALE: 1/4" = 1'

PICTURE UNITS

M.O. BRICKMOULD	43 3/4" (1111)	45 3/4" (1162)	51 3/4" (1314)	57 3/4" (1467)	59 3/4" (1518)
M.O. ADAMS/FLAT CASING	46 13/16" (1189)	48 13/16" (1240)	54 13/16" (1392)	60 13/16" (1545)	62 13/16" (1595)
ROUGH OPENING	40 3/4" (1035)	42 3/4" (1086)	48 3/4" (1238)	54 3/4" (1391)	56 3/4" (1441)
FRAME SIZE	40" (1016)	42" (1067)	48" (1219)	54" (1372)	56" (1422)
DAYLIGHT OPENING	33 7/8" (860)	35 7/8" (911)	41 7/8" (1064)	47 7/8" (1216)	49 7/8" (1267)
17 27/32" (453) 19 3/8" (492) 14 1/2" (368) 14 1/2" (368)					
21 27/32" (555) 23 3/8" (588) 18 1/2" (467) 18 1/2" (467)					
23 27/32" (606) 25 3/8" (645) 20 1/2" (517) 20 1/2" (517)					
27 27/32" (707) 29 3/8" (746) 24 1/2" (618) 24 1/2" (618)					
33 27/32" (860) 35 3/8" (899) 30 1/2" (761) 30 1/2" (761)					
35 27/32" (910) 37 3/8" (949) 32 1/2" (811) 32 1/2" (811)					
39 27/32" (1012) 41 3/8" (1051) 36 1/2" (913) 36 1/2" (913)					
43 27/32" (1114) 45 3/8" (1153) 40 1/2" (1015) 40 1/2" (1015)					
45 27/32" (1164) 47 3/8" (1203) 42 1/2" (1065) 42 1/2" (1065)					

ELEVATION SYMBOL LEGEND:
M.O. = MASONRY OPENING
 VALUES IN () ARE IN MILLIMETER CONVERSIONS.
##* NUMBER INDICATES DESIGN PRESSURE (DP) RATING WITH STANDARD GLAZING.

Note: Elevations shown DO NOT have exterior trim. Subtract 3/4" (19) from M.O. (Masonry Opening) for Unit Sizes. Masonry Openings above include Sill Nose, see Trim Options page for Sill Nose specifications. For other Trim Options refer to the Unit Sizing, Rough Opening & Masonry Openings page.

SCALE: 1/4" = 1'

PICTURE UNITS

	M.O. BRICKMOULD M.O. ADAMS/FLAT CASING ROUGH OPENING FRAME SIZE DAYLIGHT OPENING	43 3/4" (1111) 46 13/16" (1189) 40 3/4" (1035) 40" (1016) 33 7/8" (860)	45 3/4" (1162) 48 13/16" (1240) 42 3/4" (1086) 42" (1067) 35 7/8" (911)	51 3/4" (1314) 54 13/16" (1392) 48 3/4" (1238) 48" (1219) 41 7/8" (1064)	57 3/4" (1467) 60 13/16" (1545) 54 3/4" (1391) 54" (1372) 47 7/8" (1216)	59 3/4" (1518) 62 13/16" (1595) 56 3/4" (1441) 56" (1422) 49 7/8" (1267)
51 27/32" (1317) 53 3/8" (1358) 48 3/4" (1238) 49 1/4" (1249) 41 7/8" (1064)						
57 27/32" (1469) 59 3/8" (1508) 54 3/4" (1391) 54" (1372) 47 7/8" (1216)						
59 27/32" (1520) 61 3/8" (1559) 56 3/4" (1441) 57" (1422) 49 7/8" (1267)						
63 27/32" (1622) 65 3/8" (1660) 60 3/4" (1543) 60" (1524) 53 7/8" (1368)						
67 27/32" (1723) 69 3/8" (1762) 64 3/4" (1645) 64" (1626) 57 7/8" (1470)						

ELEVATION SYMBOL LEGEND:
M.O. = MASONRY OPENING
VALUES IN () ARE IN MILLIMETER CONVERSIONS.
##* NUMBER INDICATES DESIGN PRESSURE (DP) RATING WITH STANDARD GLAZING.

Note: Elevations shown DO NOT have exterior trim. Subtract 3/4" (19) from M.O. (Masonry Opening) for Unit Sizes. Masonry Openings above include Sill Nose, see Trim Options page for Sill Nose specifications. For other Trim Options refer to the Unit Sizing, Rough Opening & Masonry Openings page.

SCALE: 1/4" = 1'

PICTURE UNITS

M.O. BRICKMOULD	43 3/4"(1111)	45 3/4"(1162)	51 3/4"(1314)	57 3/4"(1467)	59 3/4"(1518)
M.O. ADAMS/FLAT CASING	46 13/16"(1189)	48 13/16"(1240)	54 13/16"(1392)	60 13/16"(1545)	62 13/16"(1595)
ROUGH OPENING	40 3/4"(1035)	42 3/4"(1086)	48 3/4"(1238)	54 3/4"(1391)	56 3/4"(1441)
FRAME SIZE	40"(1016)	42"(1067)	48"(1219)	54"(1372)	56"(1422)
DAYLIGHT OPENING	33 7/8"(860)	35 7/8"(911)	41 7/8"(1064)	47 7/8"(1216)	49 7/8"(1267)

69 2/32"(1774)
71 3/8"(1813)
66 3/4"(1695)
66"(1676)
59 7/8"(1521)

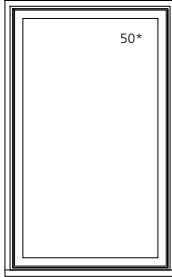

CWEC4066

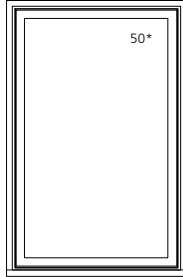

CWEC4266

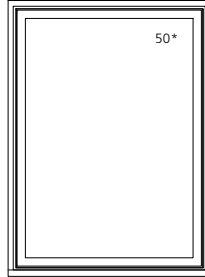

CWEC4866

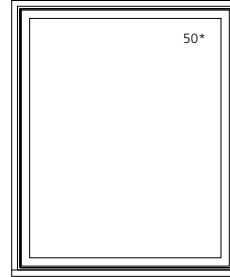

CWEC5466

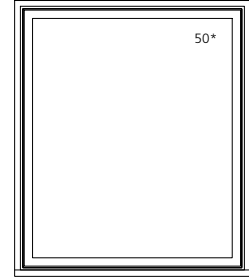

CWEC5666

75 2/32"(1926)
77 3/8"(1965)
72 3/4"(1848)
72"(1829)
65 7/8"(1673)

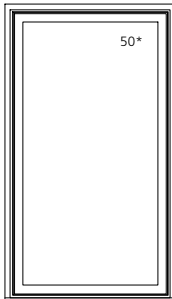

CWEC4072

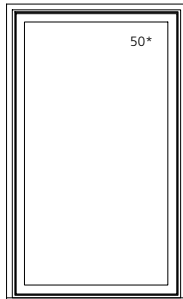

CWEC4272

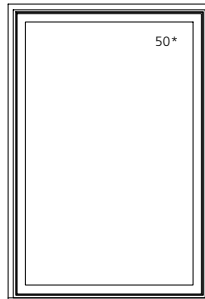

CWEC4872

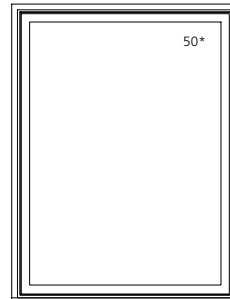

CWEC5472

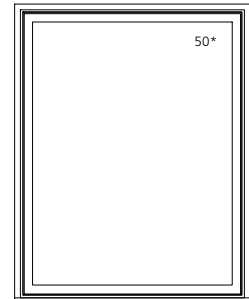

CWEC5672

81 2/32"(2079)
83 3/8"(2118)
78 3/4"(2000)
78"(1981)
71 7/8"(1826)

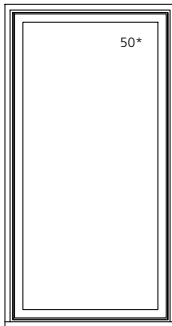

CWEC4078

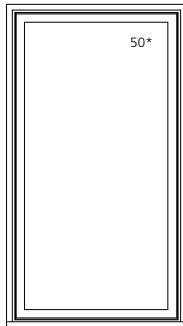

CWEC4278

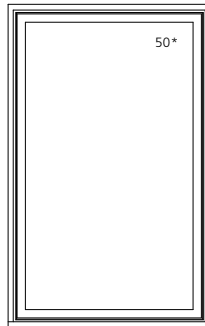

CWEC4878

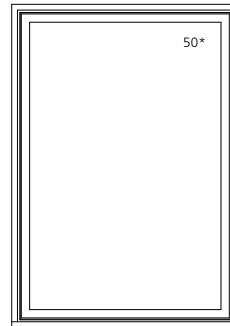

CWEC5478

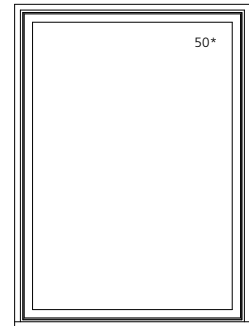

CWEC5678

87 2/32"(2231)
89 3/8"(2270)
84 3/4"(2153)
84"(2134)
77 7/8"(1978)

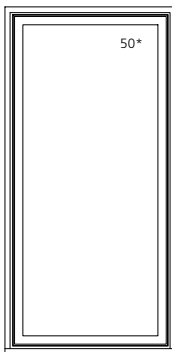

CWEC4084

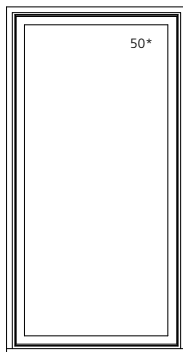

CWEC4284

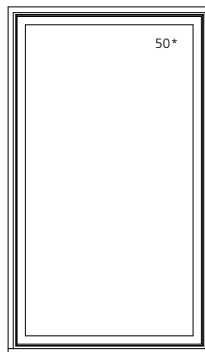

CWEC4884

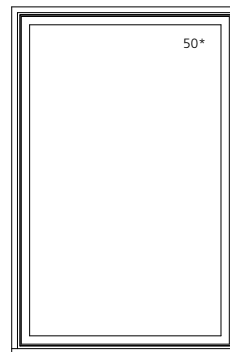

CWEC5484

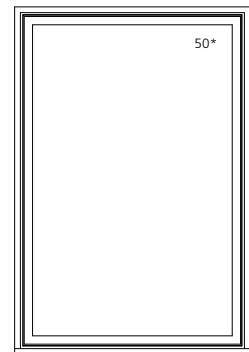

CWEC5684

ELEVATION SYMBOL LEGEND:

M.O. = MASONRY OPENING

VALUES IN () ARE IN MILLIMETER CONVERSIONS.

NUMBER INDICATES DESIGN PRESSURE (DP) RATING WITH STANDARD GLAZING.

Note: Elevations shown DO NOT have exterior trim. Subtract 3/4" (19) from M.O. (Masonry Opening) for Unit Sizes. Masonry Openings above include Sill Nose, see Trim Options page for Sill Nose specifications. For other Trim Options refer to the Unit Sizing, Rough Opening & Masonry Openings page.

SCALE: 1/4" = 1'

PICTURE UNITS

M.O. BRICKMOULD M.O. ADAMS/FLAT CASING ROUGH OPENING FRAME SIZE DAYLIGHT OPENING	63 3/4" (1619) 66 13/16" (1722) 60 3/4" (1543) 60" (1524) 53 7/8" (1368)	67 3/4" (1721) 70 13/16" (1798) 64 3/4" (1645) 64" (1626) 57 7/8" (1470)	69 3/4" (1772) 72 13/16" (1849) 66 3/4" (1695) 66" (1676) 59 7/8" (1521)	75 3/4" (1924) 78 13/16" (2001) 72 3/4" (1848) 72" (1829) 65 7/8" (1673)
17 27/32" (453) 19 3/8" (492) 14 3/4" (375) 14" (356) 7 7/8" (200)				
21 27/32" (555) 23 3/8" (588) 18 3/4" (476) 18" (457) 11 7/8" (302)				
23 27/32" (606) 25 3/8" (645) 20 3/4" (527) 20" (508) 13 7/8" (352)				
27 27/32" (707) 29 3/8" (746) 24 3/4" (629) 24" (610) 17 7/8" (454)				
33 27/32" (860) 35 3/8" (899) 30 3/4" (781) 30" (762) 23 7/8" (607)				
35 27/32" (910) 37 3/8" (949) 32 3/4" (832) 32" (813) 25 7/8" (657)				
39 27/32" (1012) 41 3/8" (1051) 36 3/4" (933) 36" (914) 29 7/8" (759)				
43 27/32" (1114) 45 3/8" (1153) 40 3/4" (1035) 40" (1016) 33 7/8" (860)				
45 27/32" (1164) 47 3/8" (1203) 42 3/4" (1086) 42" (1067) 35 7/8" (911)				

ELEVATION SYMBOL LEGEND:
M.O. = MASONRY OPENING
 VALUES IN () ARE IN MILLIMETER CONVERSIONS.
##* NUMBER INDICATES DESIGN PRESSURE (DP) RATING WITH STANDARD GLAZING.

Note: Elevations shown DO NOT have exterior trim. Subtract 3/4" (19) from M.O. (Masonry Opening) for Unit Sizes. Masonry Openings above include Sill Nose, see Trim Options page for Sill Nose specifications. For other Trim Options refer to the Unit Sizing, Rough Opening & Masonry Openings page.

SCALE: 1/4" = 1'

PICTURE UNITS

M.O. BRICKMOULD
M.O. ADAMS/FLAT CASING
ROUGH OPENING
FRAME SIZE
DAYLIGHT OPENING

63 3/4" (1619)
66 13/16" (1722)
60 3/4" (1543)
60" (1524)
53 7/8" (1368)

67 3/4" (1721)
70 13/16" (1798)
64 3/4" (1645)
64" (1626)
57 7/8" (1470)

69 3/4" (1772)
72 13/16" (1849)
66 3/4" (1695)
66" (1676)
59 7/8" (1521)

75 3/4" (1924)
78 13/16" (2001)
72 3/4" (1848)
72" (1829)
65 7/8" (1673)

51 27/32" (1317)
53 3/8" (1356)
48 3/4" (1238)
48" (1219)
41 7/8" (1064)

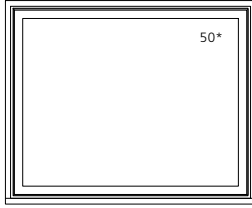

CWEC6048

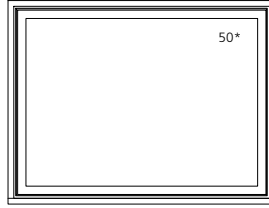

CWEC6448

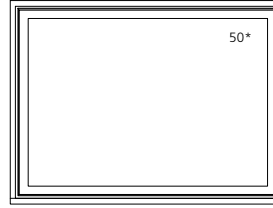

CWEC6648

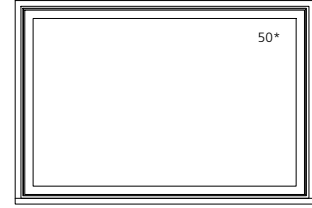

CWEC7248

57 27/32" (1469)
59 3/8" (1508)
54 3/4" (1391)
54" (1372)
47 7/8" (1216)

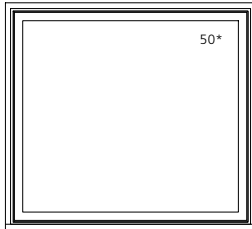

CWEC6054

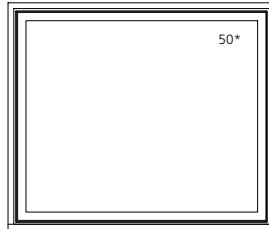

CWEC6454

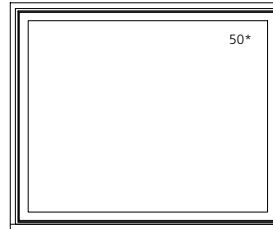

CWEC6654

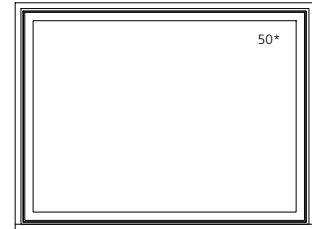

CWEC7254

59 27/32" (1520)
61 3/8" (1559)
56 3/4" (1441)
56" (1422)
49 7/8" (1267)

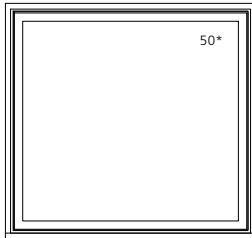

CWEC6056

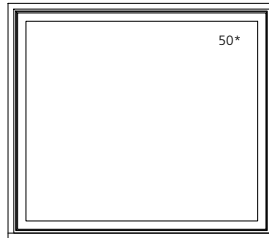

CWEC6456

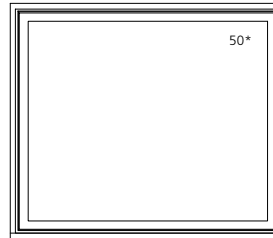

CWEC6656

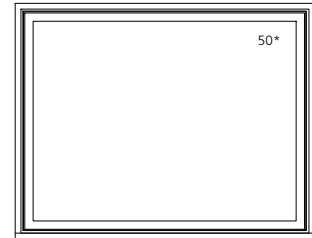

CWEC7256

63 27/32" (1622)
65 3/8" (1660)
60 3/4" (1543)
60" (1524)
53 7/8" (1368)

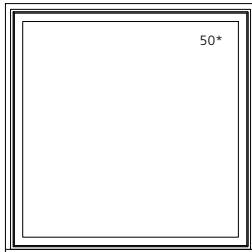

CWEC6060

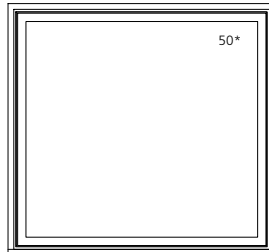

CWEC6460

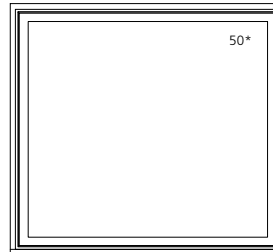

CWEC6660

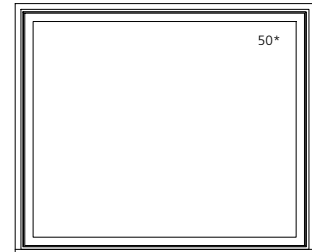

CWEC7260

67 27/32" (1723)
69 3/8" (1762)
64 3/4" (1645)
64" (1626)
57 7/8" (1470)

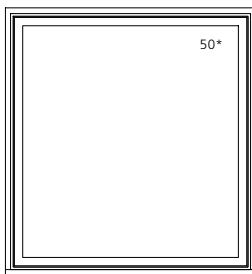

CWEC6064

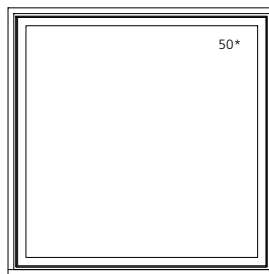

CWEC6464

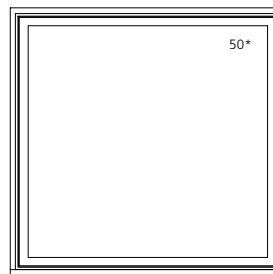

CWEC6664

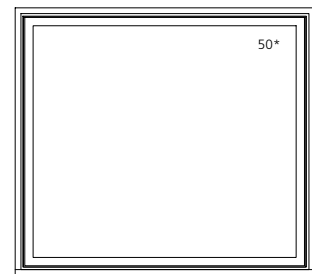

CWEC7264

ELEVATION SYMBOL LEGEND:

M.O. = MASONRY OPENING
VALUES IN () ARE IN MILLIMETER CONVERSIONS.
##* NUMBER INDICATES DESIGN PRESSURE (DP) RATING WITH STANDARD GLAZING.

Note: Elevations shown DO NOT have exterior trim. Subtract 3/4" (19) from M.O. (Masonry Opening) for Unit Sizes. Masonry Openings above include Sill Nose, see Trim Options page for Sill Nose specifications. For other Trim Options refer to the Unit Sizing, Rough Opening & Masonry Openings page.

SCALE: 1/4" = 1'

PICTURE UNITS

M.O. BRICKMOULD
M.O. ADAMS/FLAT CASING
ROUGH OPENING
FRAME SIZE
DAYLIGHT OPENING

63 3/4" (1619)
66 13/16" (1722)
60 3/4" (1543)
60" (1524)
53 7/8" (1368)

67 3/4" (1721)
70 13/16" (1798)
64 3/4" (1645)
64" (1626)
57 7/8" (1470)

69 3/4" (1772)
72 13/16" (1849)
66 3/4" (1695)
66" (1676)
59 7/8" (1521)

75 3/4" (1924)
78 13/16" (2001)
72 3/4" (1848)
72" (1829)
65 7/8" (1673)

69 27/32" (1774)
71 7/8" (1813)
66 3/4" (1695)
66" (1676)
59 7/8" (1521)

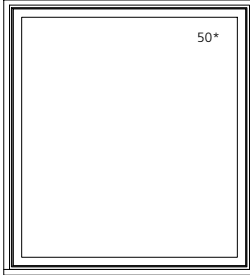

CWCEP6066

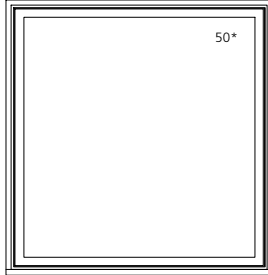

CWCEP6466

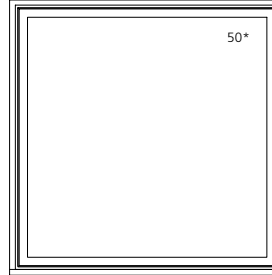

CWCEP6666

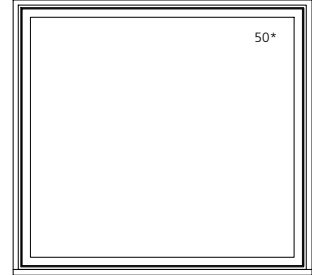

CWCEP7266

75 27/32" (1926)
77 3/8" (1955)
71 3/4" (1848)
72" (1829)
65 7/8" (1673)

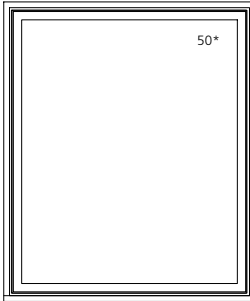

CWCEP6072

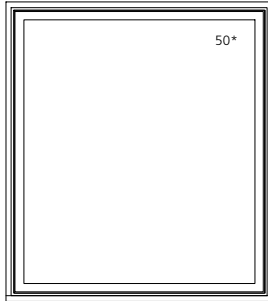

CWCEP6472

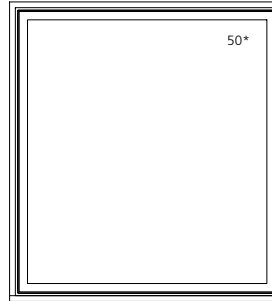

CWCEP6672

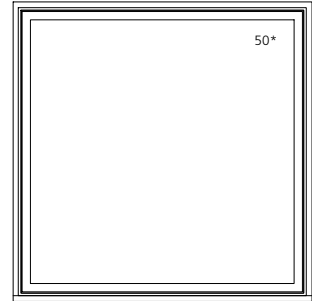

CWCEP7272

81 27/32" (2079)
83 3/8" (2118)
78 3/4" (2001)
78" (1981)
71 7/8" (1826)

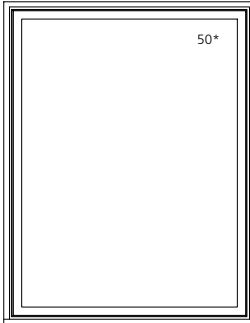

CWCEP6078

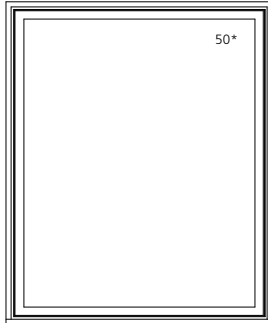

CWCEP6478

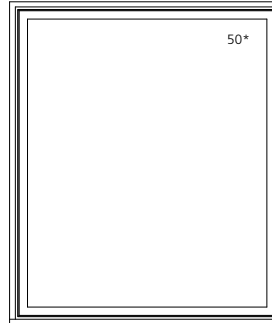

CWCEP6678

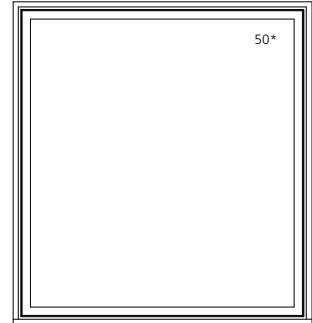

CWCEP7278

87 27/32" (2231)
89 3/8" (2270)
84 3/8" (2159)
84" (2134)
77 7/8" (1978)

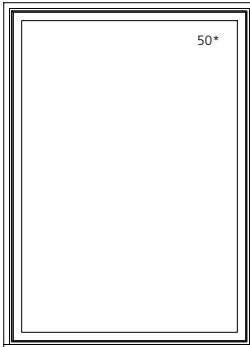

CWCEP6084

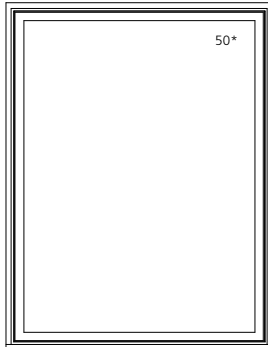

CWCEP6484

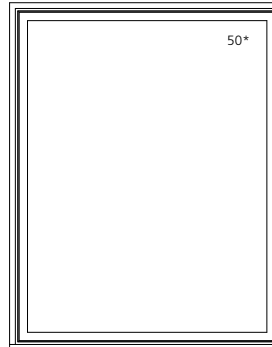

CWCEP6684

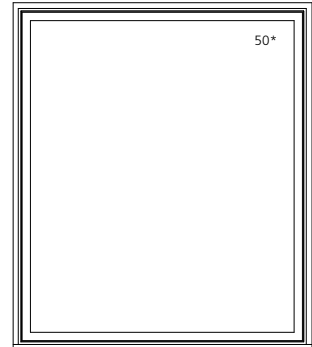

CWCEP7284

ELEVATION SYMBOL LEGEND:

M.O. = MASONRY OPENING

VALUES IN () ARE IN MILLIMETER CONVERSIONS.

##* NUMBER INDICATES DESIGN PRESSURE (DP) RATING WITH STANDARD GLAZING.

Note: Elevations shown DO NOT have exterior trim. Subtract 3/4" (19) from M.O. (Masonry Opening) for Unit Sizes. Masonry Openings above include Sill Nose, see Trim Options page for Sill Nose specifications. For other Trim Options refer to the Unit Sizing, Rough Opening & Masonry Openings page.

SCALE: 1/4" = 1'

GENERAL INFORMATION
SECTOR TOP

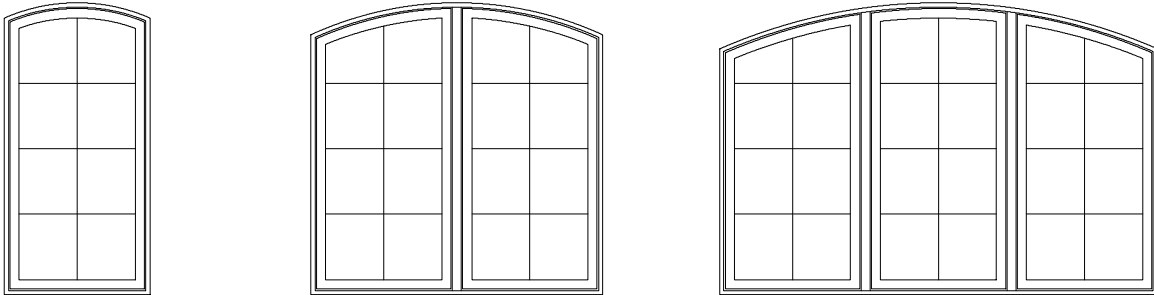

Wood Epic casement sector tops are constructed the same as EPIC primed casements, roll formed cladding on wood sash.

Wood Epic casement sector top windows are available with left or right hand operation (hinged on the springline), or stationary (non-venting). Operating mechanism includes stainless steel, corrosion resistant, butt hinges and single arm roto-type operator with hardened steel gears and operating arm. Sash locks are concealed unison type with an exposed locking lever and escutcheon plate. There are several interior hardware finish options. Refer to the Specifications for finish options.

PRIMED EPIC CASEMENT SECTOR TOPS utilize some of the same options as PRIMED EPIC CASEMENTS. Those options have not been repeated here in this sub-section.

See the PRIMED EPIC CASEMENT section for:

- Trim Options (all wood exterior trim is available as radius trim)
- Unit Sizing

SCALE: 1/4" = 1'

HANDING, OPERATION & LIMIT DEVICE
SECTOR TOP

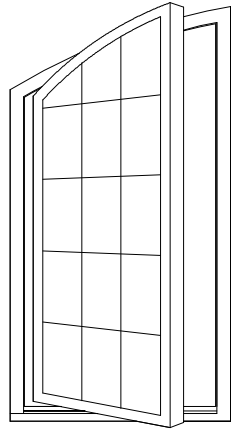

**LEFT
HAND**

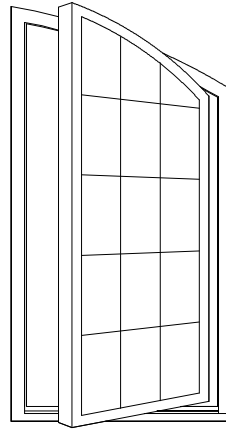

**RIGHT
HAND**

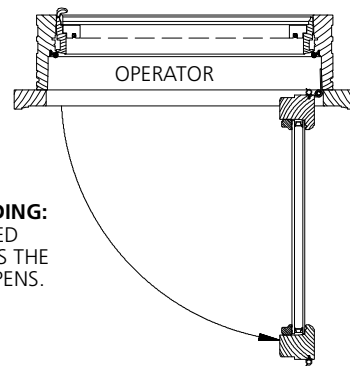
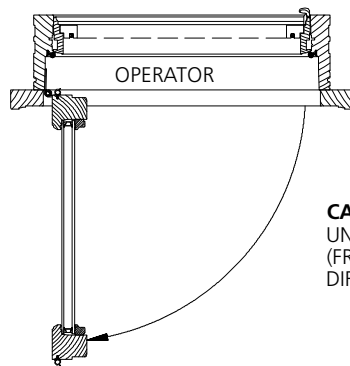

CASEMENT UNIT HANDING:
UNIT HANDING IS DEFINED
(FROM THE EXTERIOR) AS THE
DIRECTION THE SASH OPENS.

UNIT HANDING INFORMATION:

OPERATING SINGLE SECTOR UNITS - MAY BE HANDED 'LEFT' OR 'RIGHT'.

OPERATING TWIN SECTOR UNITS - THESE UNITS ARE HINGED ON THE SPRINGLINE SIDE. THE 'LEFT' SASH HAS 'LEFT' HAND OPERATION AND THE 'RIGHT' SASH HAS 'RIGHT' HAND OPERATION ONLY.

OPERATING TRIPLE SECTOR UNITS - ONLY THE FLANKING UNITS MAY BE OPERATORS WHICH ARE HINGED ON THE SPRINGLINE SIDE. THE TWO OPERATING SASH ARE HANDED THE SAME AS THE TWIN SECTOR.

ELEVATION NOTES
SECTOR TOP

ELEVATION DRAWINGS UTILIZE A LIMITED NUMBER OF PROJECTED LINES TO PRODUCE A RUDIMENTARY DRAWING INTENDED TO BE USED IN A SMALL GRAPHICAL SCALE. ELEVATIONS ARE VIEWED PERPENDICULAR FROM THE EXTERIOR OF THE STRUCTURE. IF MORE DIMENSIONS ARE NEEDED, USE THE SECTION DRAWINGS FOR MORE COMPLETE DEPICTIONS.

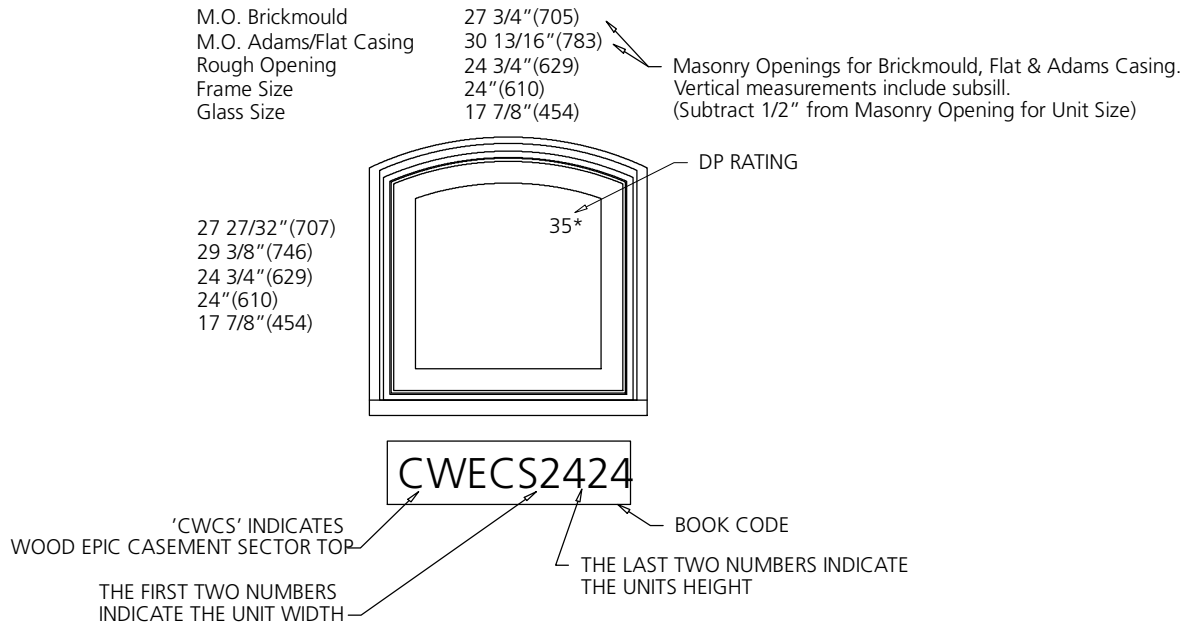

GENERAL RADIUS CASEMENT NOTES

1. UNIT ELEVATIONS ARE SHOWN WITH BRICKMOULD AND SUBSILL.
2. DIMENSIONAL VALUES IN () ARE MILLIMETER CONVERSIONS.
3. ALL SECTOR UNITS ARE AVAILABLE AS OPERATING UNITS.

ELEVATION SYMBOL LEGEND:

- ### NUMBER INDICATES DESIGN PRESSURE (DP) RATING WITH STANDARD GLAZING.
- ** BASIC UNIT REQUIRES LIMIT DEVICE ON SASH WHEN OPERATING.
- E UNIT MEETS EGRESS REQUIREMENTS FOR IRC CODE. STATE AND LOCAL EGRESS CODES MAY DIFFER. ALWAYS REFER TO LOCAL BUILDING CODES FOR COMPLETE REQUIREMENTS. CHECK WITH LOCAL OFFICIALS TO ENSURE COMPLIANCE BEFORE INSTALLING THE UNIT.
- S STATIONARY UNIT.
- LO LIMITED OPERATION.

SCALE: 1/4" = 1'

SECTOR TOP UNITS

M.O. BRICKMOULD	27 3/4" (705)	33 3/4" (857)
M.O. ADAMS/FLAT CASING	30 13/16" (783)	36 13/16" (935)
ROUGH OPENING	24 3/4" (629)	30 3/4" (781)
FRAME SIZE	24" (610)	30" (762)
DAYLIGHT OPENING	17 7/8" (454)	23 7/8" (607)
27 27/32" (707) 29 3/8" (746) 24 3/4" (629) 24" (610) 17 7/8" (454)		
33 27/32" (860) 35 3/8" (899) 30 3/4" (781) 30" (762) 23 7/8" (607)		
35 27/32" (910) 37 3/8" (949) 32 3/4" (832) 32" (813) 25 7/8" (657)		
39 27/32" (1012) 41 3/8" (1051) 36 3/4" (933) 36" (914) 29 7/8" (759)		
43 27/32" (1114) 45 3/8" (1153) 40 3/4" (1035) 40" (1016) 33 7/8" (860)		
45 27/32" (1164) 47 3/8" (1203) 42 3/4" (1086) 42" (1067) 35 7/8" (911)		
51 27/32" (1317) 53 3/8" (1356) 48 3/4" (1238) 48" (1219) 41 7/8" (1064)		

M.O. BRICKMOULD	27 3/4" (705)	33 3/4" (857)
M.O. ADAMS/FLAT CASING	30 13/16" (783)	36 13/16" (935)
ROUGH OPENING	24 3/4" (629)	30 3/4" (781)
FRAME SIZE	24" (610)	30" (762)
DAYLIGHT OPENING	17 7/8" (454)	23 7/8" (607)
57 27/32" (1469) 59 3/8" (1508) 54 3/4" (1391) 54" (1372) 47 7/8" (1216)		
59 27/32" (1520) 61 3/8" (1559) 56 3/4" (1441) 56" (1422) 49 7/8" (1267)		
63 27/32" (1622) 65 3/8" (1660) 60 3/4" (1543) 60" (1524) 53 7/8" (1368)		
67 27/32" (1723) 69 3/8" (1762) 64 3/4" (1645) 64" (1626) 57 7/8" (1470)		

ELEVATION SYMBOL LEGEND:

M.O. = MASONRY OPENING
VALUES IN () ARE IN MILLIMETER CONVERSIONS.

= NUMBER INDICATES DESIGN PRESSURE (DP) RATING WITH STANDARD GLAZING.

E UNIT MEETS EGRESS REQUIREMENTS FOR IRC CODE. STATE AND LOCAL EGRESS CODES MAY DIFFER. ALWAYS REFER TO LOCAL BUILDING CODES FOR COMPLETE REQUIREMENTS. CHECK WITH LOCAL OFFICIALS TO ENSURE COMPLIANCE BEFORE INSTALLING THE UNIT.

Note: Elevations shown DO NOT have exterior trim. Subtract 1/2" (12.7) from M.O. (Masonry Opening) for Unit Sizes. Masonry Openings above include Sill Nose, see Trim Options page for Sill Nose specifications. For other Trim Options refer to the Unit Sizing, Rough Opening & Masonry Openings page.

SCALE: 1/4" = 1'

SECTOR TOP UNITS

M.O. BRICKMOULD	27 3/4" (705)	33 3/4" (857)
M.O. ADAMS/FLAT CASING	30 13/16" (783)	36 13/16" (935)
ROUGH OPENING	24 3/4" (629)	30 3/4" (781)
FRAME SIZE	24" (610)	30" (762)
DAYLIGHT OPENING	17 7/8" (454)	23 7/8" (607)

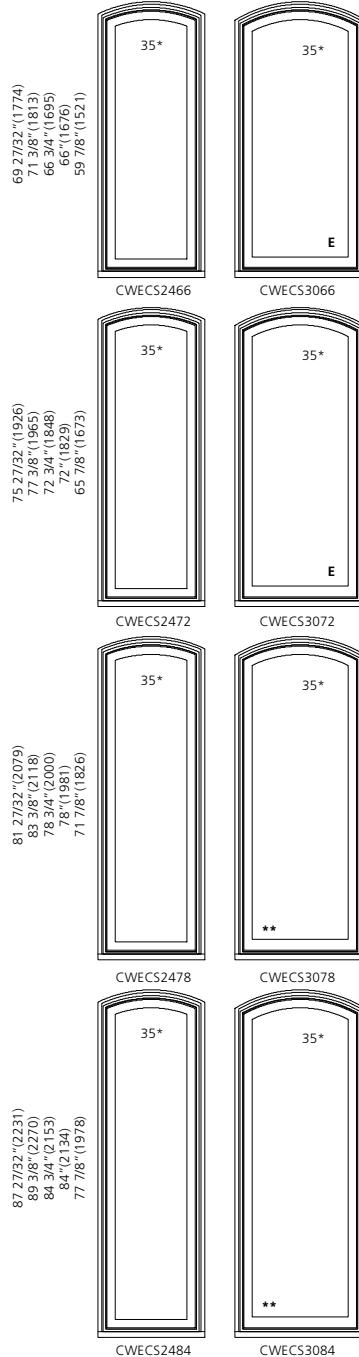

ELEVATION SYMBOL LEGEND:

M.O. = MASONRY OPENING
VALUES IN () ARE IN MILLIMETER CONVERSIONS.

NUMBER INDICATES DESIGN PRESSURE (DP) RATING WITH STANDARD GLAZING.

E UNIT MEETS EGRESS REQUIREMENTS FOR IRC CODE. STATE AND LOCAL EGRESS CODES MAY DIFFER. ALWAYS REFER TO LOCAL BUILDING CODES FOR COMPLETE REQUIREMENTS. CHECK

WITH LOCAL OFFICIALS TO ENSURE COMPLIANCE BEFORE INSTALLING THE UNIT.

****** BASIC UNIT REQUIRES LIMIT DEVICE ON SASH WHEN OPERATING.

Note: Elevations shown DO NOT have exterior trim. Subtract 1/2" (12.7) from M.O. (Masonry Opening) for Unit Sizes. Masonry Openings above include Sill Nose, see Trim Options page for Sill Nose specifications. For other Trim Options refer to the Unit Sizing, Rough Opening & Masonry Openings page.

SCALE: 1/4" = 1'

EXTENDED HALF ROUND UNITS

M.O. BRICKMOULD M.O. ADAMS/FLAT CASING ROUGH OPENING FRAME SIZE DAYLIGHT OPENING	21 3/4" (552) 24 13/16" (630) 18 3/4" (476) 18" (457) 11 7/8" (302)	23 3/4" (603) 26 13/16" (681) 20 3/4" (527) 20" (508) 13 7/8" (352)	27 3/4" (705) 30 13/16" (783) 24 3/4" (629) 24" (610) 17 7/8" (454)	31 3/4" (806) 34 13/16" (884) 28 3/4" (730) 28" (711) 21 7/8" (556)	33 3/4" (857) 36 13/16" (935) 30 3/4" (781) 30" (762) 23 7/8" (607)
27 27/32" (707) 25 3/8" (746) 24 3/4" (629) 24" (610) 17 7/8" (454)					
	CWECH1824	CWECH2024	CWECH2424		
33 27/32" (860) 35 3/8" (899) 30 3/4" (781) 30" (762) 23 7/8" (607)					
	CWECH1830	CWECH2030	CWECH2430	CWECH2830	CWECH3030
35 27/32" (910) 37 3/8" (949) 32 3/4" (832) 32" (813) 25 7/8" (657)					
	CWECH1832	CWECH2032	CWECH2432	CWECH2832	CWECH3032
39 27/32" (1012) 41 3/8" (1051) 36 3/4" (933) 36" (914) 29 7/8" (759)					
	CWECH1836	CWECH2036	CWECH2436	CWECH2836	CWECH3036
43 27/32" (1114) 45 3/8" (1153) 40 3/4" (1035) 40" (1016) 33 7/8" (860)					
	CWECH1840	CWECH2040	CWECH2440	CWECH2840	CWECH3040
45 27/32" (1164) 47 3/8" (1203) 42 3/4" (1086) 42" (1067) 35 7/8" (911)					
	CWECH1842	CWECH2042	CWECH2442	CWECH2842	CWECH3042
51 27/32" (1317) 53 3/8" (1356) 48 3/4" (1238) 48" (1219) 41 7/8" (1064)					
	CWECH1848	CWECH2048	CWECH2448	CWECH2848	CWECH3048

ELEVATION SYMBOL LEGEND:
M.O. = MASONRY OPENING
 VALUES IN () ARE IN MILLIMETER CONVERSIONS.
= NUMBER INDICATES DESIGN PRESSURE (DP) RATING WITH STANDARD GLAZING.
S = STATIONARY UNIT.

Note: Elevations shown DO NOT have exterior trim. Subtract 1/2" (12.7) from M.O. (Masonry Opening) for Unit Sizes. Masonry Openings above include Sill Nose, see Trim Options page for Sill Nose specifications. For other Trim Options refer to the Unit Sizing, Rough Opening & Masonry Openings page.

SCALE: 1/4" = 1'

EXTENDED HALF ROUND UNITS

	M.O. BRICKMOULD	21 3/4" (552)	23 3/4" (603)	27 3/4" (705)	31 3/4" (806)	33 3/4" (857)	
	M.O. ADAMS/FLAT CASING	24 13/16" (630)	26 13/16" (681)	30 13/16" (783)	34 13/16" (884)	36 13/16" (935)	
	ROUGH OPENING	18 3/4" (476)	20 3/4" (527)	24 3/4" (629)	28 3/4" (730)	30 3/4" (781)	
	FRAME SIZE	18" (457)	20" (508)	24" (610)	28" (711)	30" (762)	
	DAYLIGHT OPENING	11 7/8" (302)	13 7/8" (352)	17 7/8" (454)	21 7/8" (556)	23 7/8" (607)	
57 27/32" (1469) 59 3/8" (1508) 54 3/4" (1391) 54" (1372) 47 7/8" (1216)							
	CWECH1854	CWECH2054	CWECH2454	CWECH2854	CWECH3054		
	59 27/32" (1520) 61 3/8" (1559) 56 3/4" (1441) 56" (1422) 49 7/8" (1267)						
		CWECH1856	CWECH2056	CWECH2456	CWECH2856	CWECH3056	
		63 27/32" (1622) 65 3/8" (1660) 60 3/4" (1543) 60" (1524) 53 7/8" (1368)					
CWECH1860			CWECH2060	CWECH2460	CWECH2860	CWECH3060	
67 27/32" (1723) 69 3/8" (1762) 64 3/4" (1645) 64" (1626) 57 7/8" (1470)							
	CWECH1864		CWECH2064	CWECH2464	CWECH2864	CWECH3064	
	69 27/32" (1774) 71 3/8" (1813) 66 3/4" (1695) 66" (1676) 59 7/8" (1521)						
		CWECH1866	CWECH2066	CWECH2466	CWECH2866	CWECH3066	

ELEVATION SYMBOL LEGEND:

- M.O. = MASONRY OPENING
- VALUES IN () ARE IN MILLIMETER CONVERSIONS
- ### NUMBER INDICATES DESIGN PRESSURE (DP) RATING WITH STANDARD GLAZING.
- E UNIT MEETS EGRESS REQUIREMENTS FOR IRC CODE, STATE AND LOCAL EGRESS CODES MAY DIFFER. ALWAYS REFER TO LOCAL BUILDING CODES FOR COMPLETE REQUIREMENTS. CHECK WITH LOCAL OFFICIALS TO ENSURE COMPLIANCE BEFORE INSTALLING THE UNIT.

Note: Elevations shown DO NOT have exterior trim. Subtract 1/2" (12.7) from M.O. (Masonry Opening) for Unit Sizes. Masonry Openings above include Sill Nose, see Trim Options page for Sill Nose specifications. For other Trim Options refer to the Unit Sizing, Rough Opening & Masonry Openings page.

SCALE: 1/4" = 1'

EXTENDED HALF ROUND UNITS

M.O. BRICKMOULD	21 3/4" (552)	23 3/4" (603)	27 3/4" (705)	31 3/4" (806)	33 3/4" (857)
M.O. ADAMS/FLAT CASING	24 13/16" (630)	26 13/16" (681)	30 13/16" (783)	34 13/16" (884)	36 13/16" (935)
ROUGH OPENING	18 3/4" (476)	20 3/4" (527)	24 3/4" (629)	28 3/4" (730)	30 3/4" (781)
FRAME SIZE	18" (457)	20" (508)	24" (610)	28" (711)	30" (762)
DAYLIGHT OPENING	11 7/8" (302)	13 7/8" (352)	17 7/8" (454)	21 7/8" (556)	23 7/8" (607)

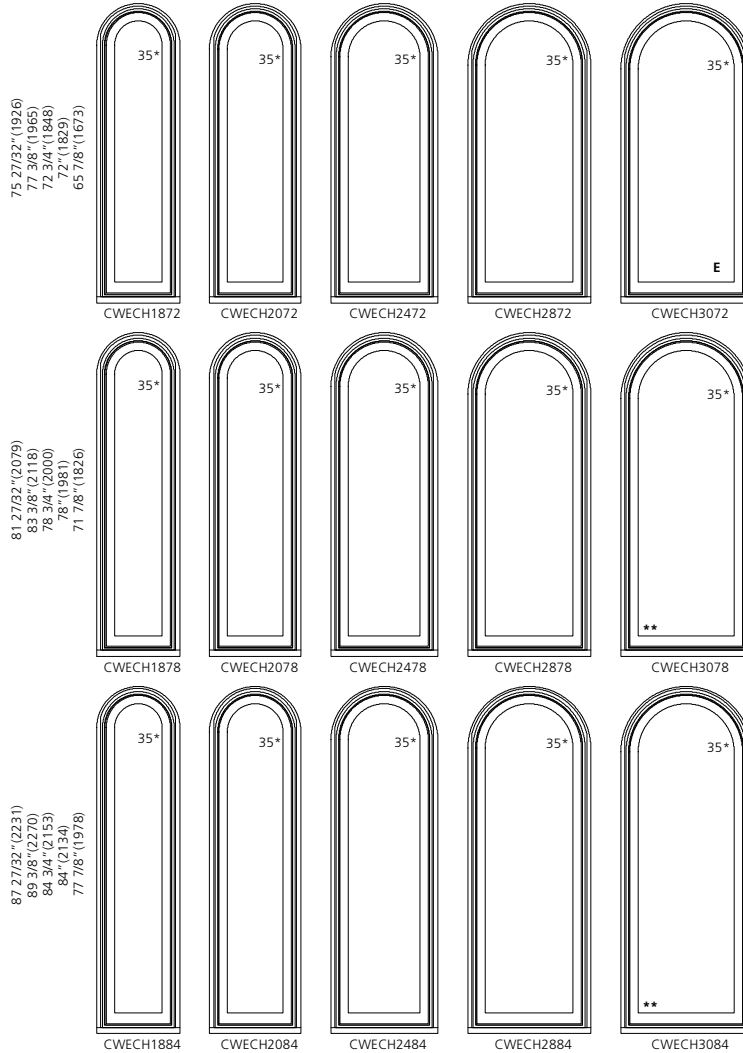

ELEVATION SYMBOL LEGEND:

- M.O.** = MASONRY OPENING
- VALUES IN () ARE IN MILLIMETER CONVERSIONS.
- ##** = NUMBER INDICATES DESIGN PRESSURE (DP) RATING WITH STANDARD GLAZING.
- E** = UNIT MEETS EGRESS REQUIREMENTS FOR IRC CODE. STATE AND LOCAL EGRESS CODES MAY DIFFER. ALWAYS REFER TO LOCAL BUILDING CODES FOR COMPLETE REQUIREMENTS. CHECK WITH LOCAL OFFICIALS TO ENSURE COMPLIANCE BEFORE INSTALLING THE UNIT.
- **** = BASIC UNIT REQUIRES LIMIT DEVICE ON SASH WHEN OPERATING.

Note: Elevations shown DO NOT have exterior trim. Subtract 1/2" (12.7) from M.O. (Masonry Opening) for Unit Sizes. Masonry Openings above include Sill Nose, see Trim Options page for Sill Nose specifications. For other Trim Options refer to the Unit Sizing, Rough Opening & Masonry Openings page.

SCALE: 1/4" = 1'

EXTENDED QUARTER ROUND UNITS

M.O. BRICKMOULD	21 3/4" (552)	23 3/4" (603)	27 3/4" (705)	31 3/4" (806)	33 3/4" (857)
M.O. ADAMS/FLAT CASING	24 13/16" (630)	26 13/16" (681)	30 13/16" (783)	34 13/16" (884)	36 13/16" (935)
ROUGH OPENING	18 3/4" (476)	20 3/4" (527)	24 3/4" (629)	28 3/4" (730)	30 3/4" (781)
FRAME SIZE	18" (457)	20" (508)	24" (610)	28" (586)	30" (762)
DAYLIGHT OPENING	11 7/8" (302)	13 7/8" (352)	17 7/8" (454)	21 7/8" (556)	23 7/8" (607)
33 27/32" (860) 35 3/8" (899) 30 3/4" (781) 30" (762) 23 7/8" (607)					
	CWECQ1830	CWECQ2030	CWECQ2430		
35 27/32" (910) 37 3/8" (949) 32 3/4" (832) 32" (813) 25 7/8" (657)					
	CWECQ1832	CWECQ2032	CWECQ2432		
39 27/32" (1012) 41 3/8" (1051) 36 3/4" (933) 36" (914) 29 7/8" (759)					
	CWECQ1836	CWECQ2036	CWECQ2436	CWECQ2836	CWECQ3036
43 27/32" (1114) 45 3/8" (1153) 40 3/4" (1035) 40" (1016) 33 7/8" (860)					
	CWECQ1840	CWECQ2040	CWECQ2440	CWECQ2840	CWECQ3040
45 27/32" (1164) 45 3/8" (1203) 42 3/4" (1086) 42" (1067) 35 7/8" (911)					
	CWECQ1842	CWECQ2042	CWECQ2442	CWECQ2842	CWECQ3042
51 27/32" (1317) 53 3/8" (1356) 48 3/4" (1238) 48" (1219) 41 7/8" (1064)					
	CWECQ1848	CWECQ2048	CWECQ2448	CWECQ2848	CWECQ3048
57 27/32" (1469) 59 3/8" (1508) 54 3/4" (1391) 54" (1372) 47 7/8" (1216)					
	CWECQ1854	CWECQ2054	CWECQ2454	CWECQ2854	CWECQ3054
59 27/32" (1520) 61 3/8" (1559) 56 3/4" (1441) 56" (1422) 49 7/8" (1267)					
	CWECQ1856	CWECQ2056	CWECQ2456	CWECQ2856	CWECQ3056
63 27/32" (1622) 65 3/8" (1660) 60 3/4" (1543) 60" (1524) 53 7/8" (1368)					
	CWECQ1860	CWECQ2060	CWECQ2460	CWECQ2860	CWECQ3060
67 27/32" (1723) 69 3/8" (1762) 64 3/4" (1645) 64" (1626) 57 7/8" (1470)					
	CWECQ1864	CWECQ2064	CWECQ2464	CWECQ2864	CWECQ3064

ELEVATION SYMBOL LEGEND:
M.O. = MASONRY OPENING
 VALUES IN () ARE IN MILLIMETER CONVERSIONS.
##* NUMBER INDICATES DESIGN PRESSURE (DP) RATING WITH STANDARD GLAZING.
S STATIONARY UNIT.

Note: Elevations shown DO NOT have exterior trim. Subtract 1/2" (12.7) from M.O. (Masonry Opening) for Unit Sizes. Masonry Openings above include Sill Nose, see Trim Options page for Sill Nose specifications. For other Trim Options refer to the Unit Sizing, Rough Opening & Masonry Openings page.

SCALE: 1/8" = 1'

EXTENDED QUARTER ROUND UNITS

M.O. BRICKMOULD	21 3/4" (552)	23 3/4" (603)	27 3/4" (705)	31 3/4" (806)	33 3/4" (857)
M.O. ADAMS/FLAT CASING	24 13/16" (630)	26 13/16" (681)	30 13/16" (783)	34 13/16" (884)	36 13/16" (935)
ROUGH OPENING	18 3/4" (476)	20 3/4" (527)	24 3/4" (629)	28 3/4" (730)	30 3/4" (781)
FRAME SIZE	18" (457)	20" (508)	24" (610)	28" (586)	30" (762)
DAYLIGHT OPENING	11 7/8" (302)	13 7/8" (352)	17 7/8" (454)	21 7/8" (556)	23 7/8" (607)

69 27/32" (1774) 71 3/8" (1813) 66 3/4" (1695) 66" (1676) 59 7/8" (1520)					
	CWECQ1866	CWECQ2066	CWECQ2466	CWECQ2866	CWECQ3066
75 27/32" (1926) 77 3/8" (1965) 72 3/4" (1848) 72" (1829) 65 7/8" (1673)					
	CWECQ1872	CWECQ2072	CWECQ2472	CWECQ2872	CWECQ3072
81 27/32" (2079) 83 3/8" (2118) 78 3/4" (2000) 78" (1981) 71 7/8" (1826)					
	CWECQ1878	CWECQ2078	CWECQ2478	CWECQ2878	CWECQ3078
87 27/32" (2231) 89 3/8" (2270) 84 3/4" (2153) 84" (2134) 77 7/8" (1978)					
	CWECQ1884	CWECQ2084	CWECQ2484	CWECQ2884	CWECQ3084

ELEVATION SYMBOL LEGEND:
M.O. = MASONRY OPENING
 VALUES IN () ARE IN MILLIMETER CONVERSIONS.
##* NUMBER INDICATES DESIGN PRESSURE (DP) RATING WITH STANDARD GLAZING.
S STATIONARY UNIT.
LO LIMITED OPERATION.

Note: Elevations shown DO NOT have exterior trim. Subtract 1/2" (12.7) from M.O. (Masonry Opening) for Unit Sizes. Masonry Openings above include Sill Nose, see Trim Options page for Sill Nose specifications. For other Trim Options refer to the Unit Sizing, Rough Opening & Masonry Openings page.

**GLAZING OPTIONS
CASEMENT**

INTERIOR GLAZED
INSULATED 3/4" [19] GLASS

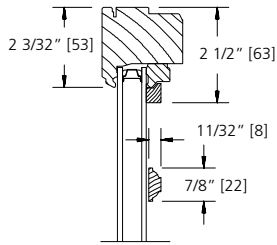

7/8" GRILLE BAR

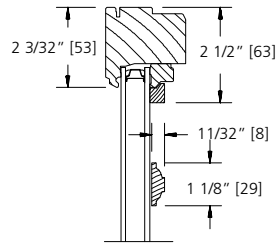

1 1/8" GRILLE BAR

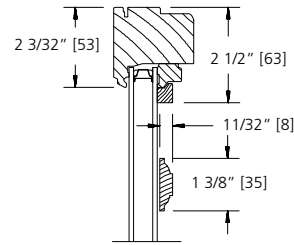

1 3/8" GRILLE BAR

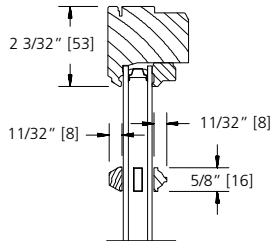

**5/8" SDL BAR
(PUTTY/BEAD)**

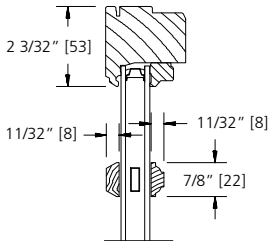

**7/8" SDL BAR
(PUTTY/BEAD)**

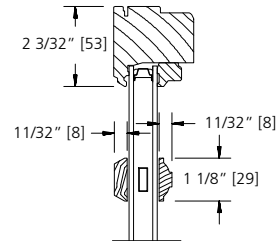

**1 1/8" SDL BAR
(PUTTY/BEAD)**

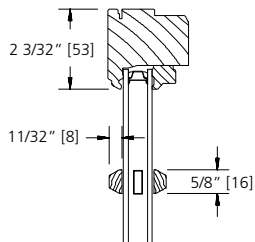

**5/8" SDL BAR
(PUTTY/PUTTY)**

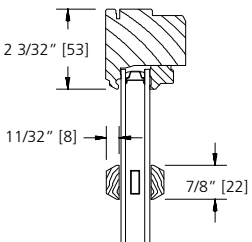

**7/8" SDL BAR
(PUTTY/PUTTY)**

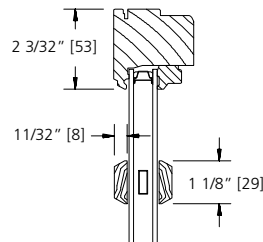

**1 1/8" SDL BAR
(PUTTY/PUTTY)**

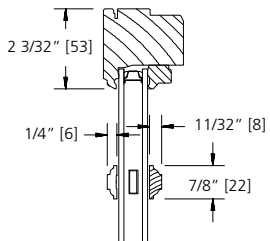

**7/8" SDL BAR
(BEAD STOP)**

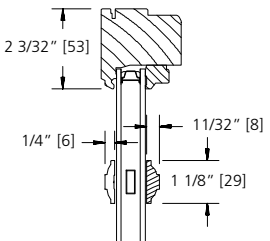

**1 1/8" SDL BAR
(BEAD STOP)**

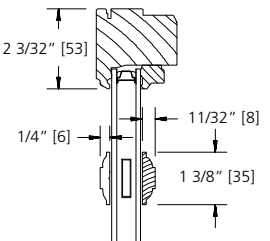

**1 3/8" SDL BAR
(BEAD STOP)**

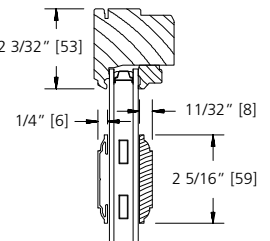

**2 5/16" SDL BAR
(BEAD STOP)**

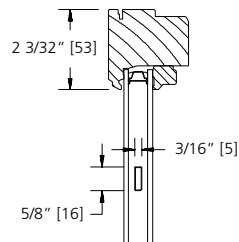

**5/8" FLAT
GBG**

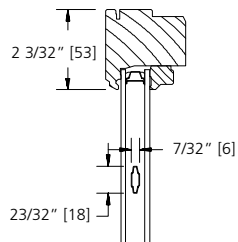

**23/32" CONTOUR
GBG**

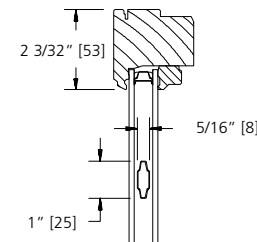

**1" CONTOUR
GBG**

SCALE: NTS

**GLAZING OPTIONS
CASEMENT**

INTERIOR GLAZED
SINGLE GLAZED 1/8" [3] GLASS

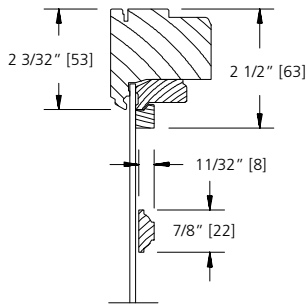

7/8" GRILLE BAR

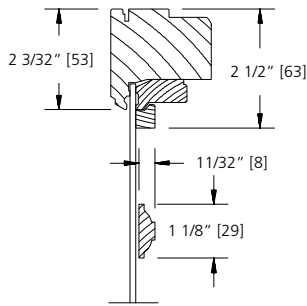

1 1/8" GRILLE BAR

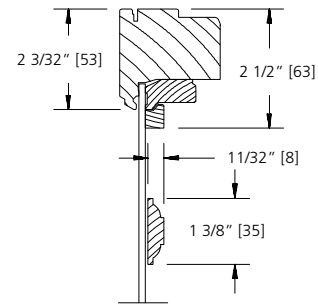

1 3/8" GRILLE BAR

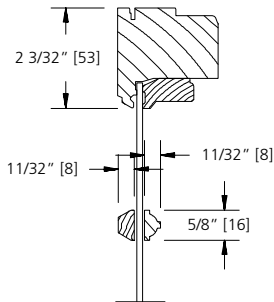

**5/8" SDL
(PUTTY/BEAD)**

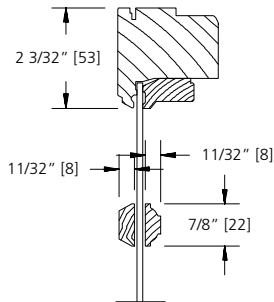

**7/8" SDL
(PUTTY/BEAD)**

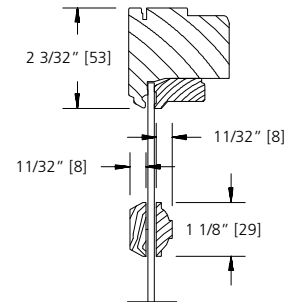

**1 1/8" SDL
(PUTTY/BEAD)**

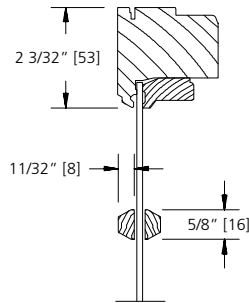

**5/8" SDL
(PUTTY/PUTTY)**

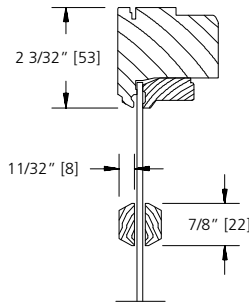

**7/8" SDL
(PUTTY/PUTTY)**

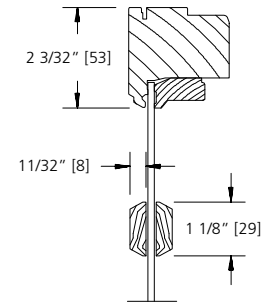

**1 1/8" SDL
(PUTTY/PUTTY)**

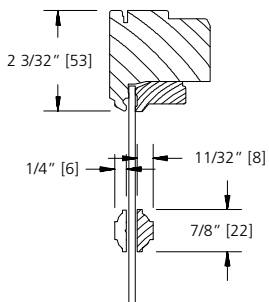

**7/8" SDL
(BEAD STOP)**

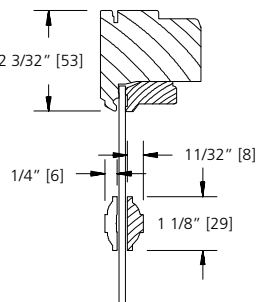

**1 1/8" SDL
(BEAD STOP)**

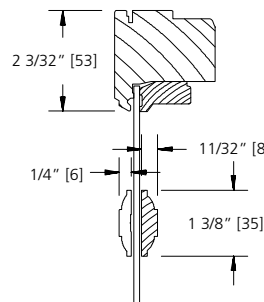

**1 3/8" SDL
(BEAD STOP)**

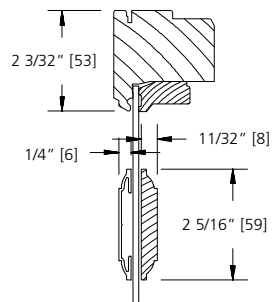

**2 5/16" SDL BAR
(BEAD STOP)**

SCALE: 3" = 1'

**GLAZING OPTIONS
CASEMENT**

**INTERIOR GLAZED
IMPACT RESISTANT GLASS**

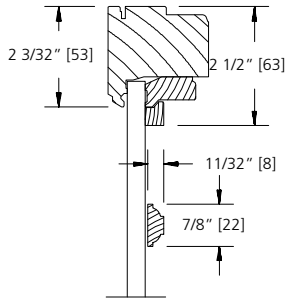

7/8" GRILLE BAR

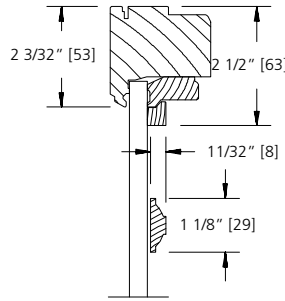

1 1/8" GRILLE BAR

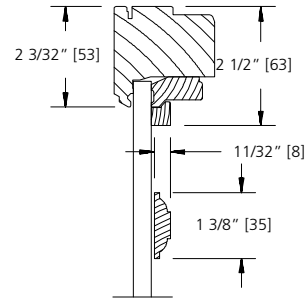

1 3/8" GRILLE BAR

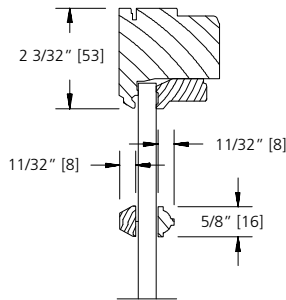

**5/8" SDL
(PUTTY/BEAD)**

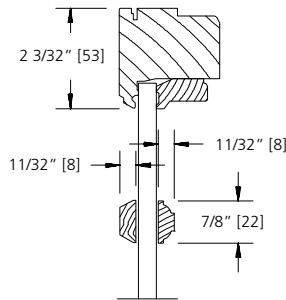

**7/8" SDL
(PUTTY/BEAD)**

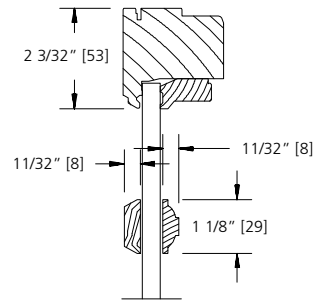

**1 1/8" SDL
(PUTTY/BEAD)**

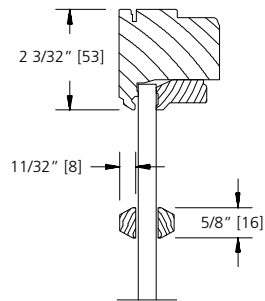

**5/8" SDL
(PUTTY/PUTTY)**

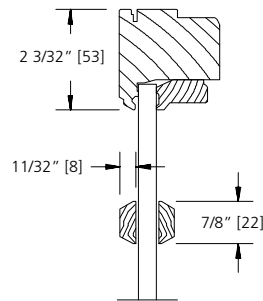

**7/8" SDL
(PUTTY/PUTTY)**

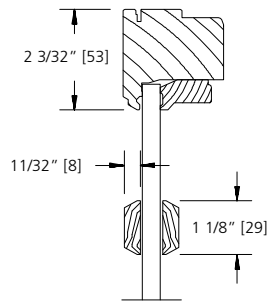

**1 1/8" SDL
(PUTTY/PUTTY)**

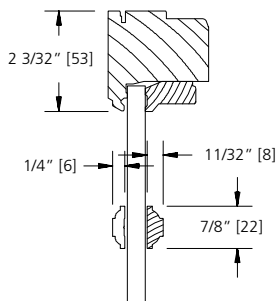

**7/8" SDL
(BEAD STOP)**

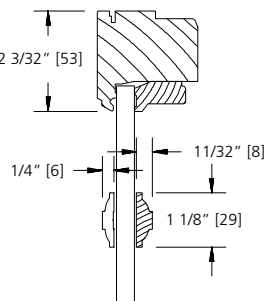

**1 1/8" SDL
(BEAD STOP)**

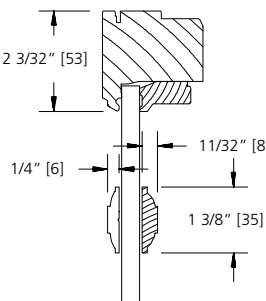

**1 3/8" SDL
(BEAD STOP)**

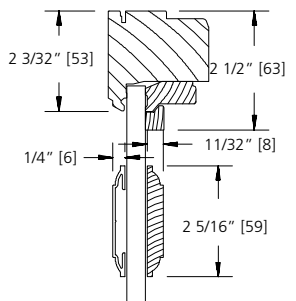

**2 5/16" SDL BAR
(BEAD STOP)**

SCALE: 3" = 1'

**GLAZING OPTIONS
STATIONARY CASEMENT**

INTERIOR GLAZED
INSULATED 3/4" [19] GLASS

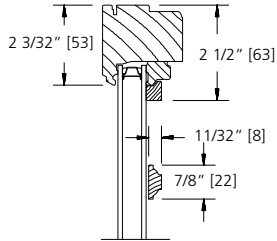

7/8" GRILLE BAR

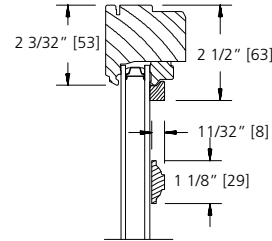

1 1/8" GRILLE BAR

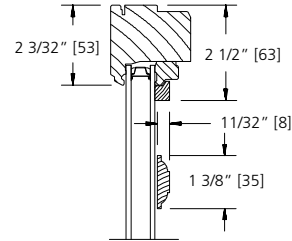

1 3/8" GRILLE BAR

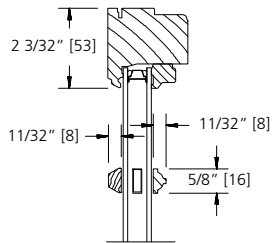

**5/8" SDL BAR
(PUTTY/BEAD)**

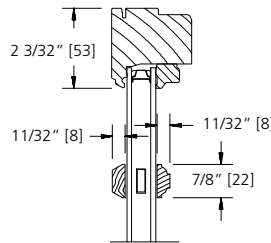

**7/8" SDL BAR
(PUTTY/BEAD)**

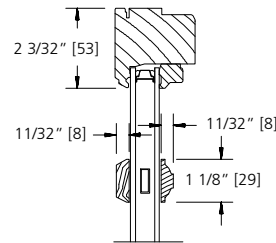

**1 1/8" SDL BAR
(PUTTY/BEAD)**

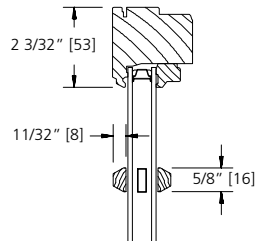

**5/8" SDL BAR
(PUTTY/PUTTY)**

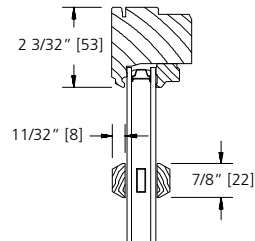

**7/8" SDL BAR
(PUTTY/PUTTY)**

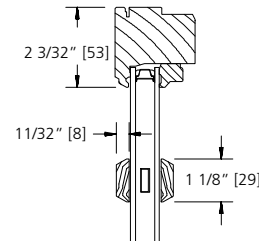

**1 1/8" SDL BAR
(PUTTY/PUTTY)**

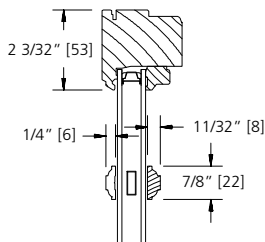

**7/8" SDL BAR
(BEAD STOP)**

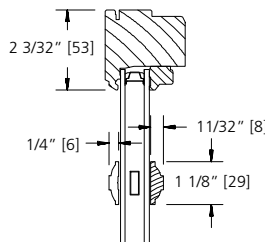

**1 1/8" SDL BAR
(BEAD STOP)**

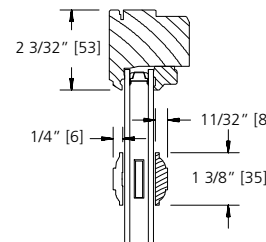

**1 3/8" SDL BAR
(BEAD STOP)**

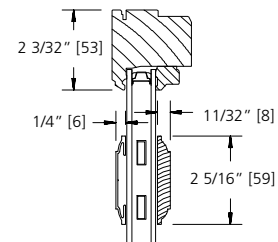

**2 5/16" SDL BAR
(BEAD STOP)**

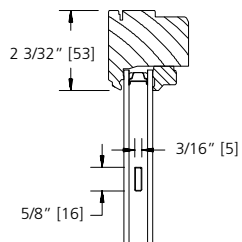

**5/8" FLAT
GBG**

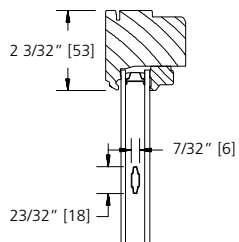

**23/32" CONTOUR
GBG**

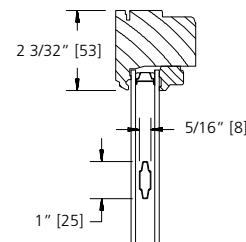

**1" CONTOUR
GBG**

SCALE: NTS

**GLAZING OPTIONS
STATIONARY CASEMENT**

INTERIOR GLAZED
SINGLE GLAZED 1/8" [3] GLASS

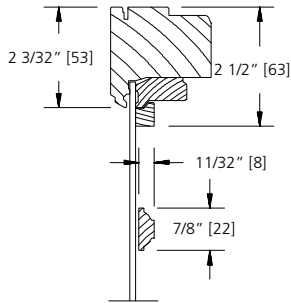

7/8" GRILLE BAR

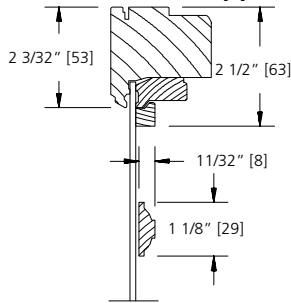

1 1/8" GRILLE BAR

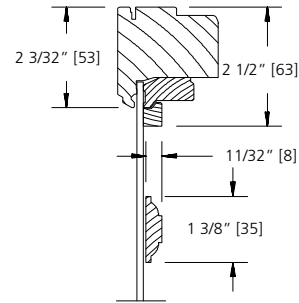

1 3/8" GRILLE BAR

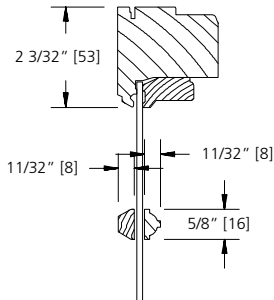

**5/8" SDL
(PUTTY/BEAD)**

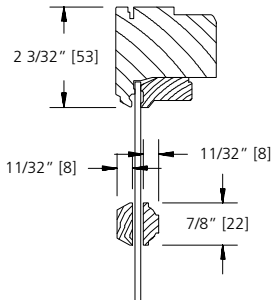

**7/8" SDL
(PUTTY/BEAD)**

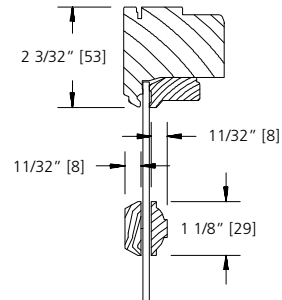

**1 1/8" SDL
(PUTTY/BEAD)**

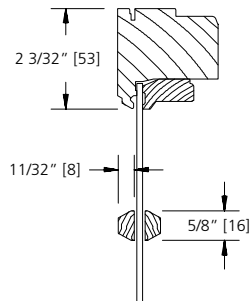

**5/8" SDL
(PUTTY/PUTTY)**

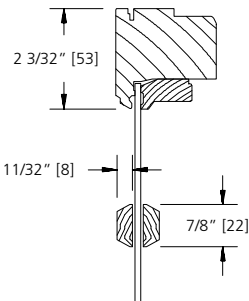

**7/8" SDL
(PUTTY/PUTTY)**

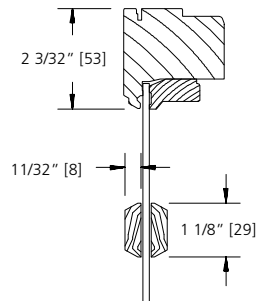

**1 1/8" SDL
(PUTTY/PUTTY)**

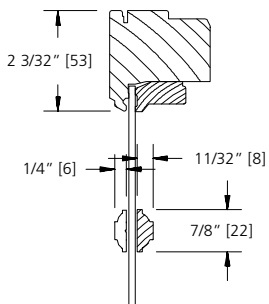

**7/8" SDL
(BEAD STOP)**

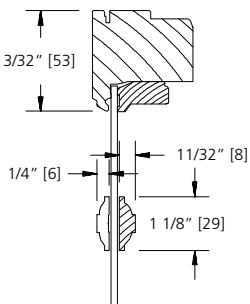

**1 1/8" SDL
(BEAD STOP)**

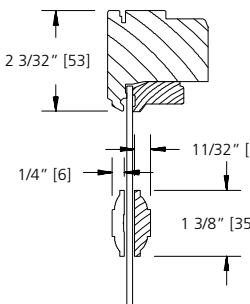

**1 3/8" SDL
(BEAD STOP)**

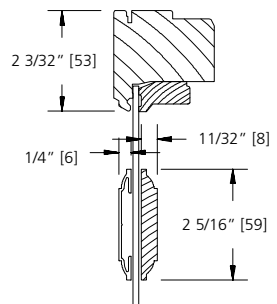

**2 5/16" SDL BAR
(BEAD STOP)**

SCALE: 3" = 1'

**GLAZING OPTIONS
STATIONARY CASEMENT**

**INTERIOR GLAZED
IMPACT RESISTANT GLASS**

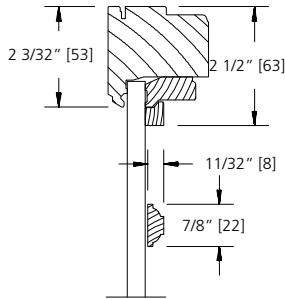

7/8" GRILLE BAR

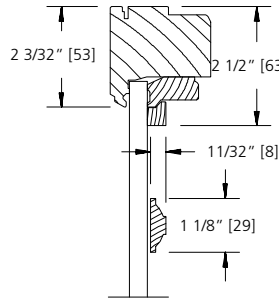

1 1/8" GRILLE BAR

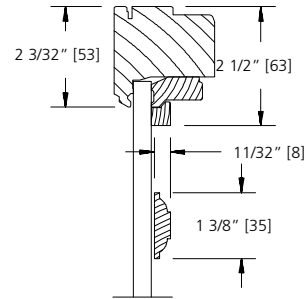

1 3/8" GRILLE BAR

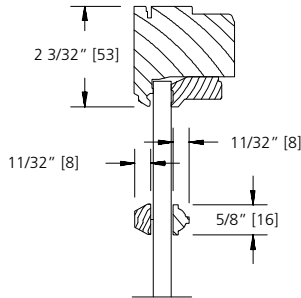

**5/8" SDL
(PUTTY/BEAD)**

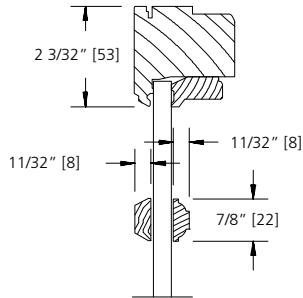

**7/8" SDL
(PUTTY/BEAD)**

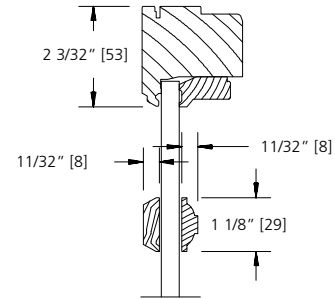

**1 1/8" SDL
(PUTTY/BEAD)**

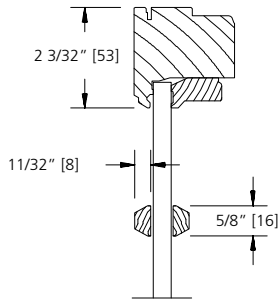

**5/8" SDL
(PUTTY/PUTTY)**

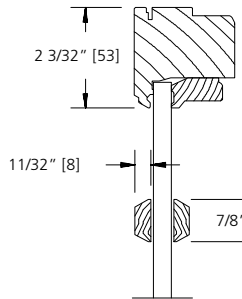

**7/8" SDL
(PUTTY/PUTTY)**

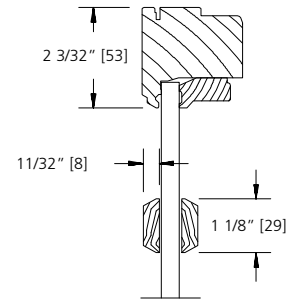

**1 1/8" SDL
(PUTTY/PUTTY)**

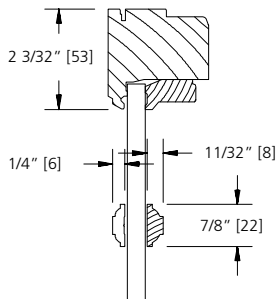

**7/8" SDL
(BEAD STOP)**

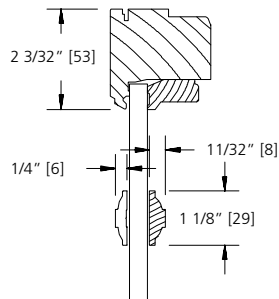

**1 1/8" SDL
(BEAD STOP)**

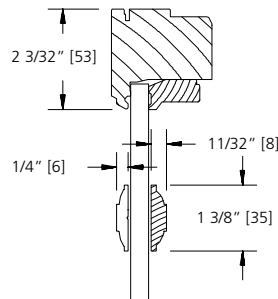

**1 3/8" SDL
(BEAD STOP)**

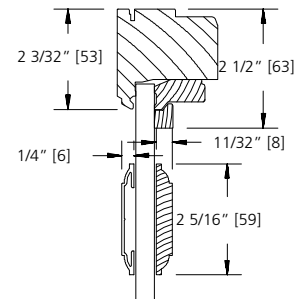

**2 5/16" SDL BAR
(BEAD STOP)**

SCALE: 3" = 1'

**GLAZING OPTIONS
SECTOR TOP CASEMENT**

INTERIOR GLAZED
INSULATED 15/16" [24] GLASS

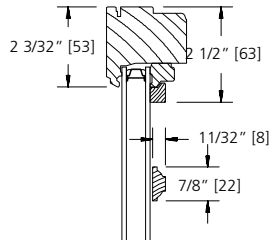

7/8" GRILLE BAR

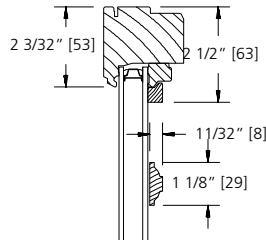

1 1/8" GRILLE BAR

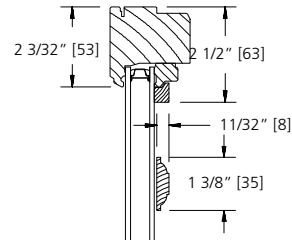

1 3/8" GRILLE BAR

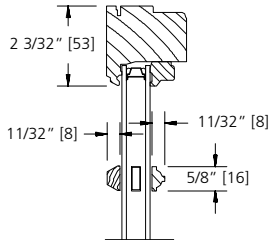

**5/8" SDL BAR
(PUTTY/BEAD)**

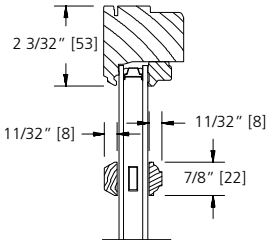

**7/8" SDL BAR
(PUTTY/BEAD)**

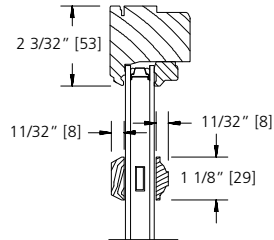

**1 1/8" SDL BAR
(PUTTY/BEAD)**

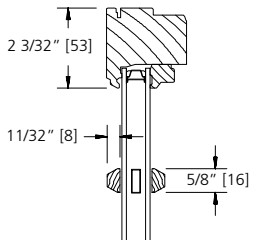

**5/8" SDL BAR
(PUTTY/PUTTY)**

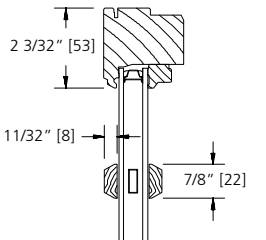

**7/8" SDL BAR
(PUTTY/PUTTY)**

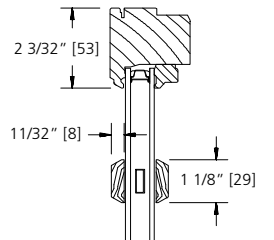

**1 1/8" SDL BAR
(PUTTY/PUTTY)**

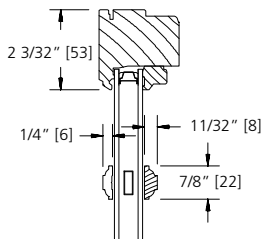

**7/8" SDL BAR
(BEAD STOP)**

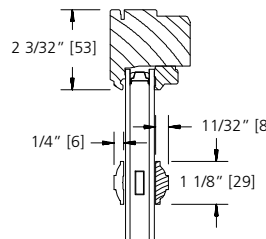

**1 1/8" SDL BAR
(BEAD STOP)**

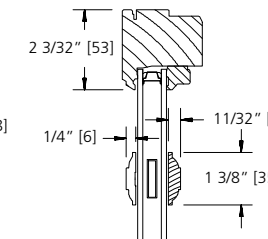

**1 3/8" SDL BAR
(BEAD STOP)**

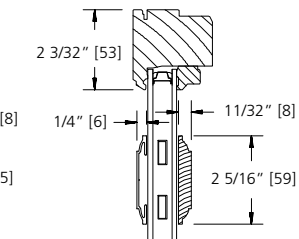

**2 5/16" SDL BAR
(BEAD STOP)**

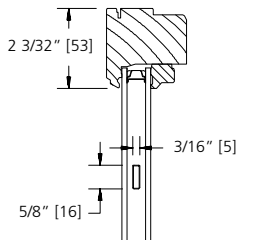

**5/8" FLAT
GBG**

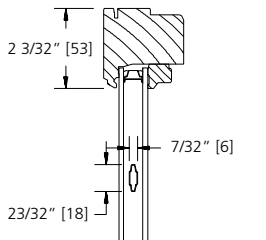

**23/32" CONTOUR
GBG**

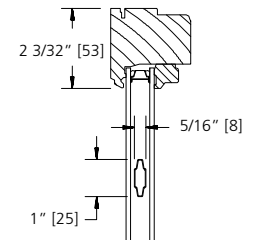

**1" CONTOUR
GBG**

SCALE: NTS

GLAZING OPTIONS
SECTOR TOP CASEMENT

INTERIOR GLAZED
SINGLE GLAZED 1/8" [3] GLASS

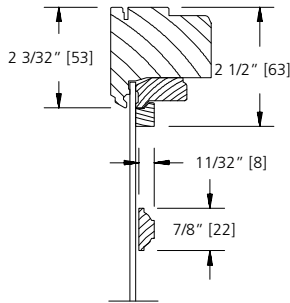

7/8" GRILLE BAR

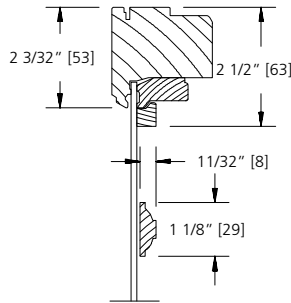

1 1/8" GRILLE BAR

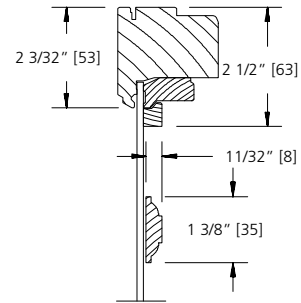

1 3/8" GRILLE BAR

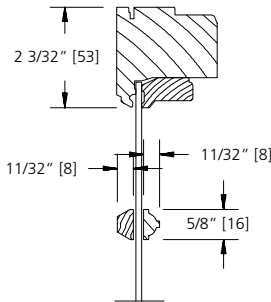

5/8" SDL
(PUTTY/BEAD)

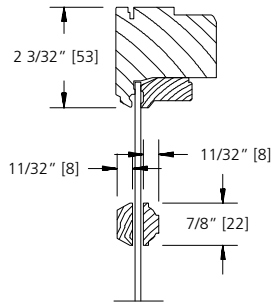

7/8" SDL
(PUTTY/BEAD)

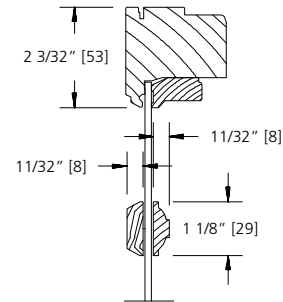

1 1/8" SDL
(PUTTY/BEAD)

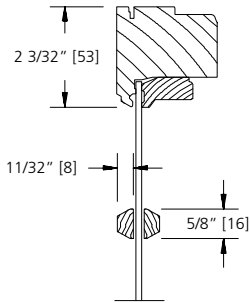

5/8" SDL
(PUTTY/PUTTY)

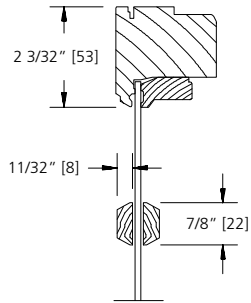

7/8" SDL
(PUTTY/PUTTY)

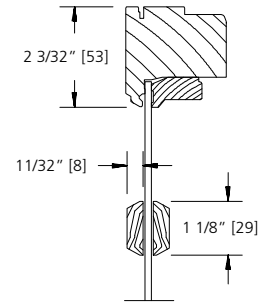

1 1/8" SDL
(PUTTY/PUTTY)

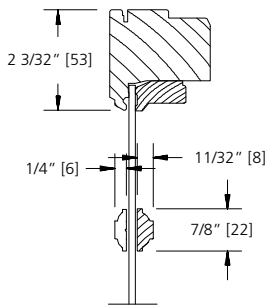

7/8" SDL
(BEAD STOP)

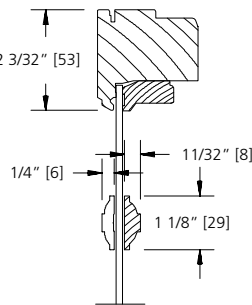

1 1/8" SDL
(BEAD STOP)

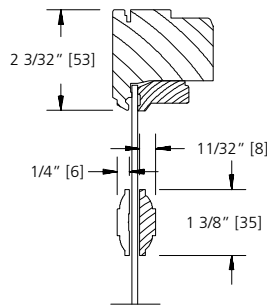

1 3/8" SDL
(BEAD STOP)

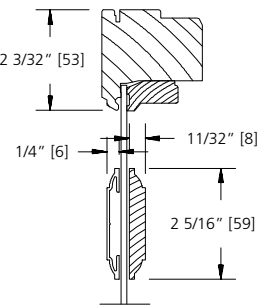

2 5/16" SDL BAR
(BEAD STOP)

SCALE: 3" = 1'

**GLAZING OPTIONS
SECTOR TOP CASEMENT**

**INTERIOR GLAZED
IMPACT RESISTANT GLASS**

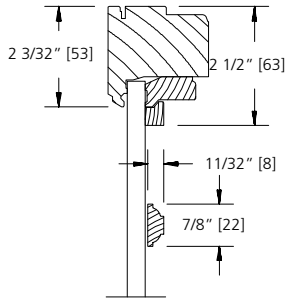

7/8" GRILLE BAR

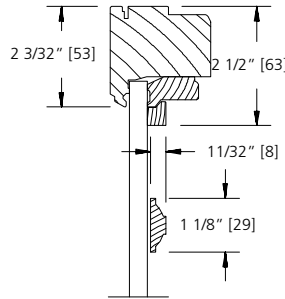

1 1/8" GRILLE BAR

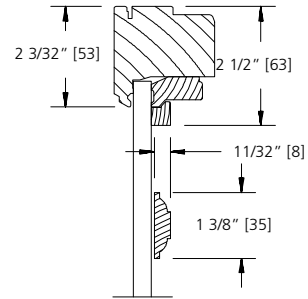

1 3/8" GRILLE BAR

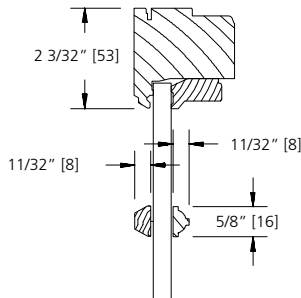

**5/8" SDL
(PUTTY/BEAD)**

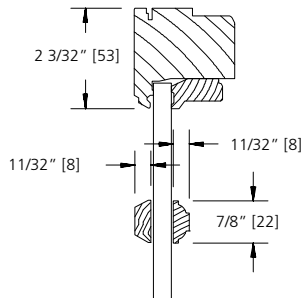

**7/8" SDL
(PUTTY/BEAD)**

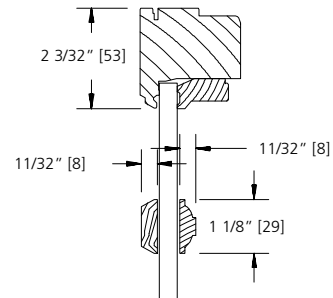

**1 1/8" SDL
(PUTTY/BEAD)**

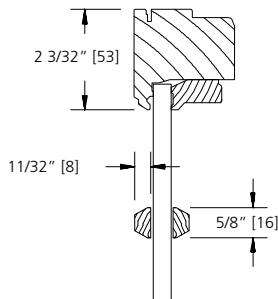

**5/8" SDL
(PUTTY/PUTTY)**

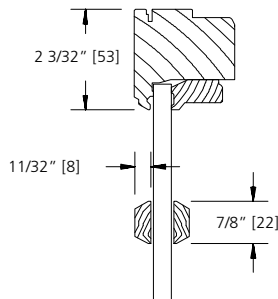

**7/8" SDL
(PUTTY/PUTTY)**

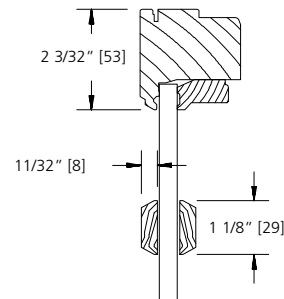

**1 1/8" SDL
(PUTTY/PUTTY)**

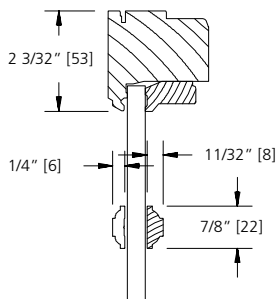

**7/8" SDL
(BEAD STOP)**

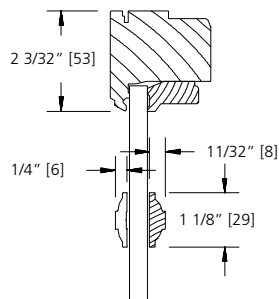

**1 1/8" SDL
(BEAD STOP)**

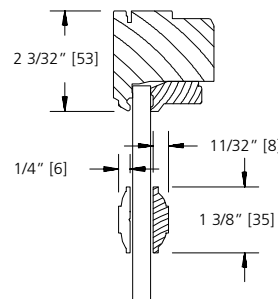

**1 3/8" SDL
(BEAD STOP)**

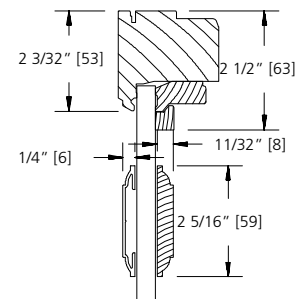

**2 5/16" SDL BAR
(BEAD STOP)**

SCALE: 3" = 1'

TRIM OPTIONS
CASEMENT

WOOD EXTERIOR TRIM

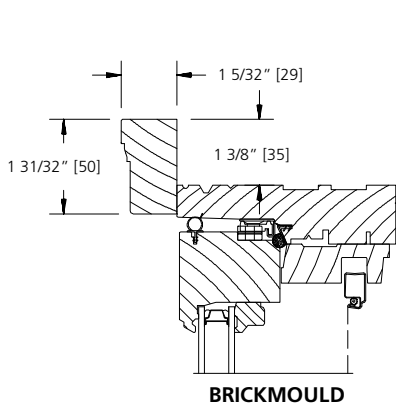

BRICKMOULD

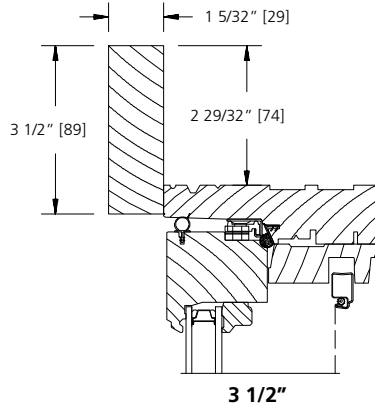

3 1/2\"/>

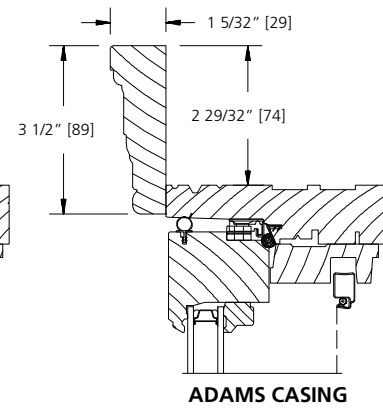

ADAMS CASING

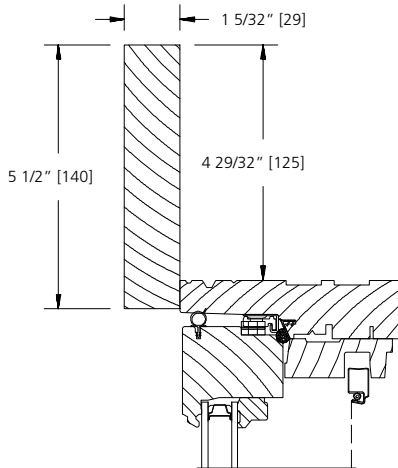

5 1/2\"/>

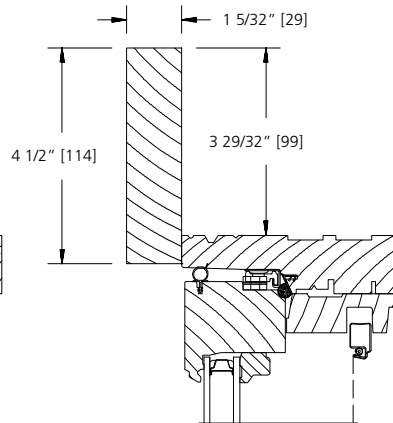

4 1/2\"/>

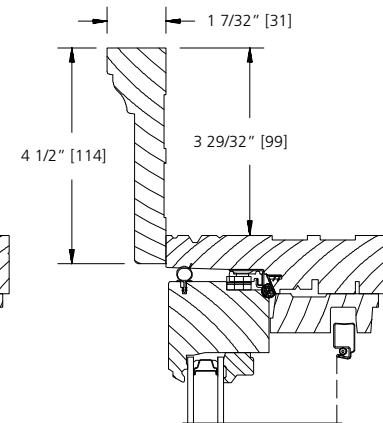

**1 X 4
BACKBAND CASING**

WOOD SUBSILL OPTIONS

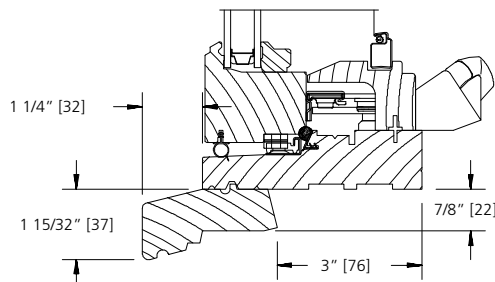

WOOD SUBSILL

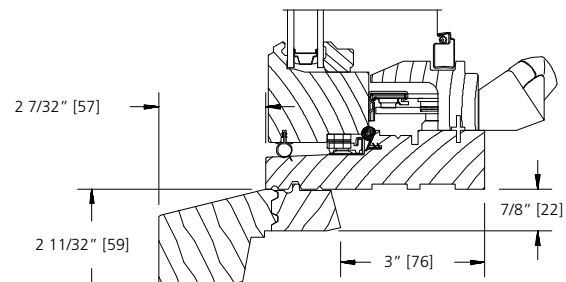

WOOD HISTORICAL SUBSILL

SCALE: 3" = 1'

**TRIM OPTIONS
STATIONARY CASEMENT**

WOOD EXTERIOR TRIM

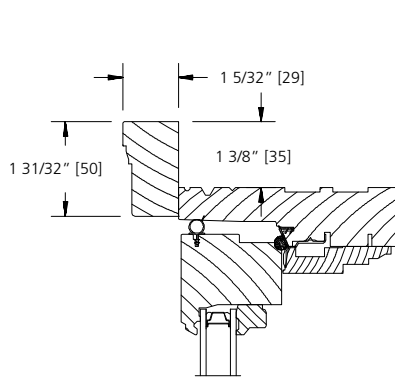

BRICKMOULD

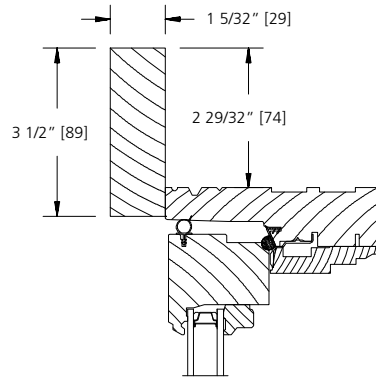

3 1/2\"/>

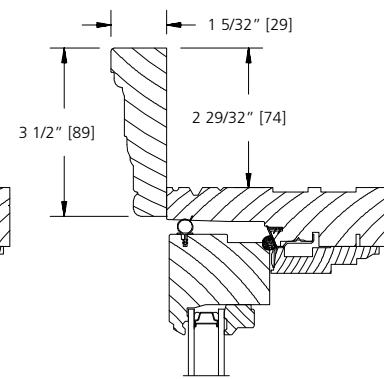

ADAMS CASING

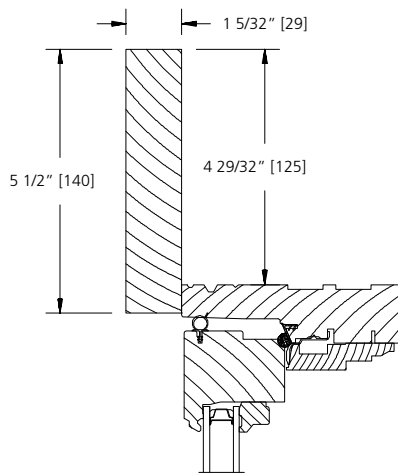

5 1/2\"/>

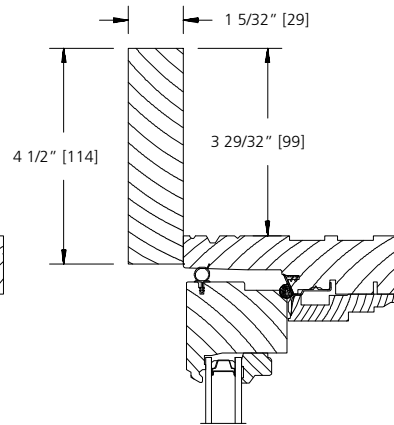

4 1/2\"/>

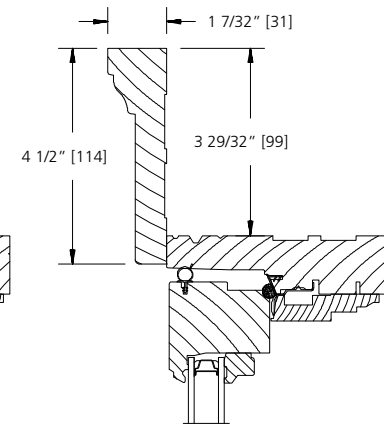

**1 X 4
BACKBAND CASING**

WOOD SUBSILL OPTIONS

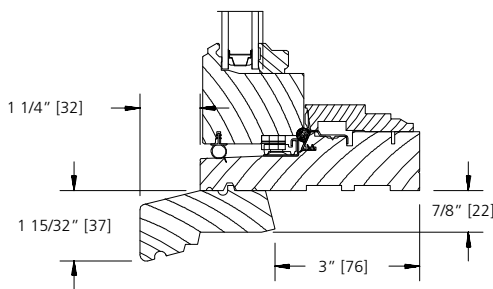

WOOD SUBSILL

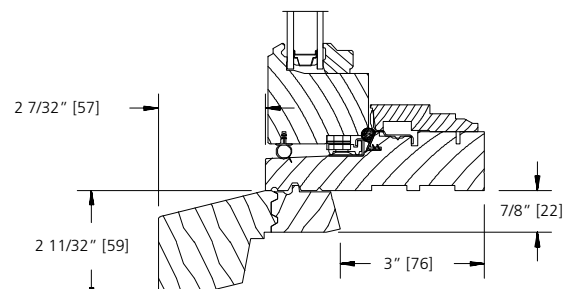

WOOD HISTORICAL SUBSILL

SCALE: 3" = 1'

LITE CUT INFORMATION
CASEMENT & STATIONARY

Wood Epic casement windows are available with removable grilles in 5/8", 7/8", 1-1/8" and 1-3/8" widths, Airspace (between the panes) grilles, and Simuated Divided Lites. Standard ;ote cits are rectangular.

LITE CUT OPTIONS

Special lite cut patterns can include a wide variety of straight line and radius patterns. The illustrations shown here represent just a few of the possibilities. Rectangular, horizontal, vertical and Prairie lite patterns are available in all standard size wood casement windows. Uneven, diamond, radius and Gothic lite cuts are available, subject to approval. Approvals are based on the ability to fulfill the design requirement while maintaining the construction integrity of the finished product.

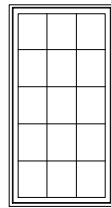

RECTANGULAR

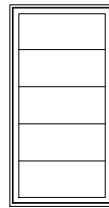

HORIZONTAL

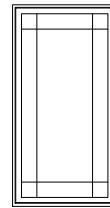

PRAIRIE

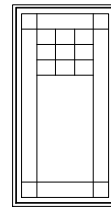

UNEVEN

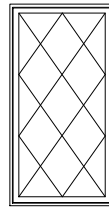

DIAMOND

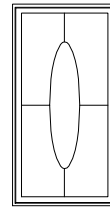

RADIUS

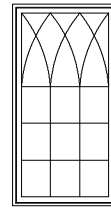

GOTHIC

BAR ALIGNMENT

Alignment of divided lite muntin bars from one window to the next is often required by fine architectural design. Wood grilles, Grilles between the glass, and Simulated Divided Lites may be specified with muntin bars aligned.

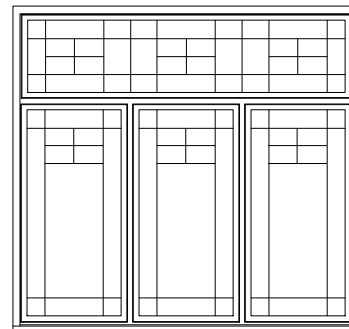

**UNIT SIZING, ROUGH OPENINGS
& MASONRY OPENINGS
CASEMENT**

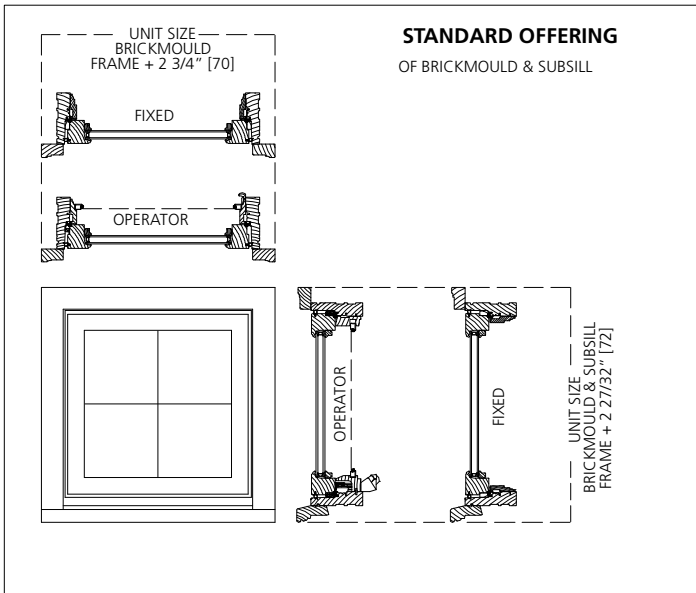

GENERAL NOTES:

UNITS WITH NO TRIM AND SUBSILL:
UNIT SIZE = FRAME SIZE

UNIT SIZE IS ALWAYS THE
EXTREME SIZE OF THE WINDOW
WITH OR WITHOUT TRIM

MASONRY OPENING:
MASONRY OPENING IS ALWAYS 1/2" OVER
THE UNIT SIZE OF THE WINDOW

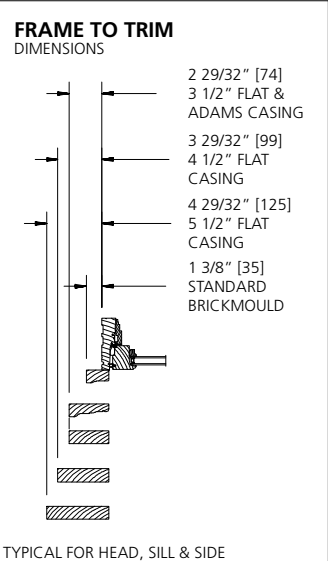
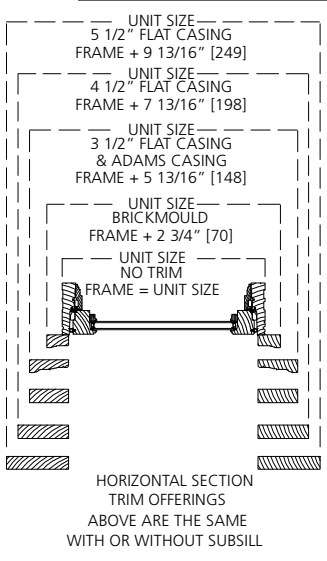
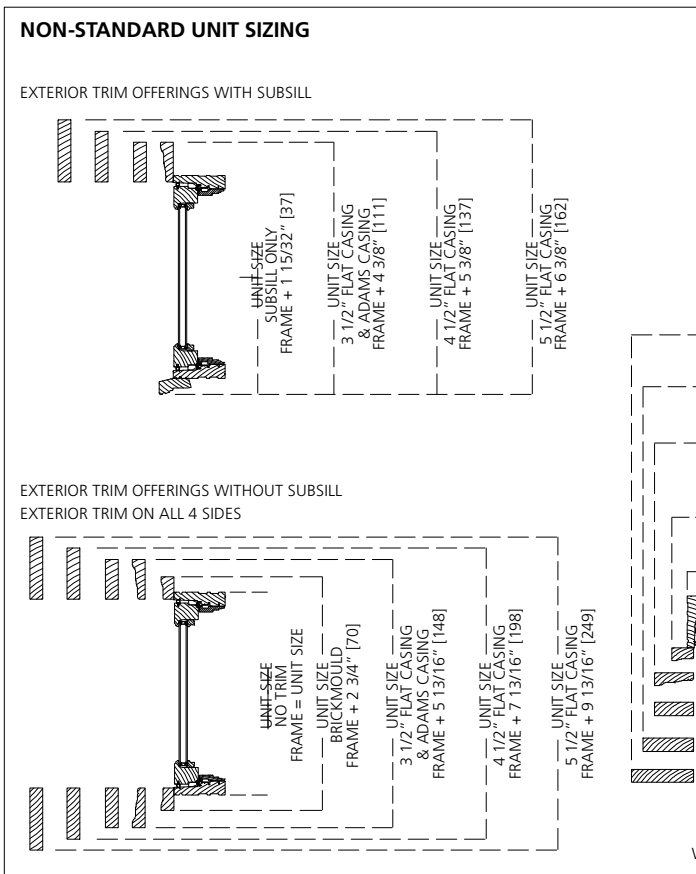
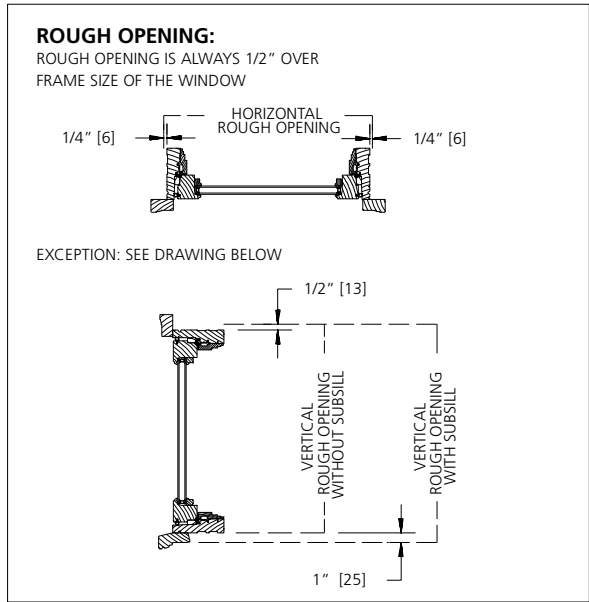

**UNIT SIZING, ROUGH OPENINGS
& MASONRY OPENINGS
STATIONARY CASEMENT**

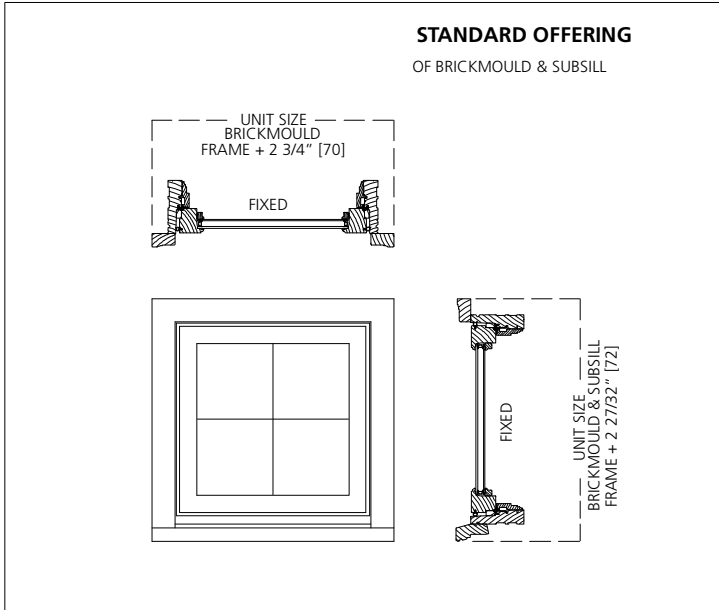

GENERAL NOTES:

UNITS WITH NO TRIM AND SUBSILL:
UNIT SIZE = FRAME SIZE

UNIT SIZE IS ALWAYS THE
EXTREME SIZE OF THE WINDOW
WITH OR WITHOUT TRIM

MASONRY OPENING:
MASONRY OPENING IS ALWAYS 1/2" OVER
THE UNIT SIZE OF THE WINDOW

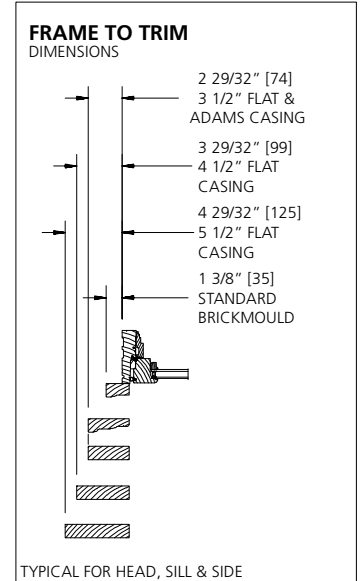
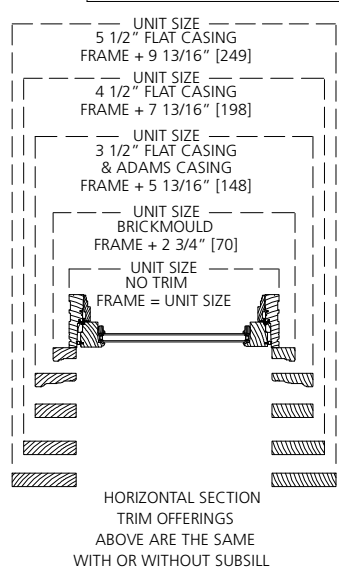
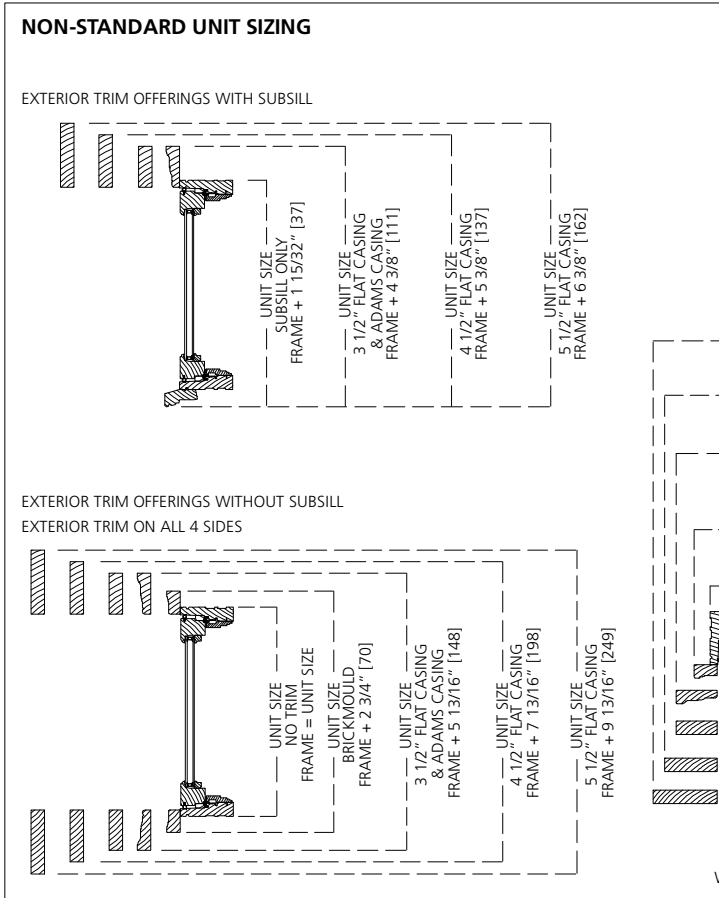
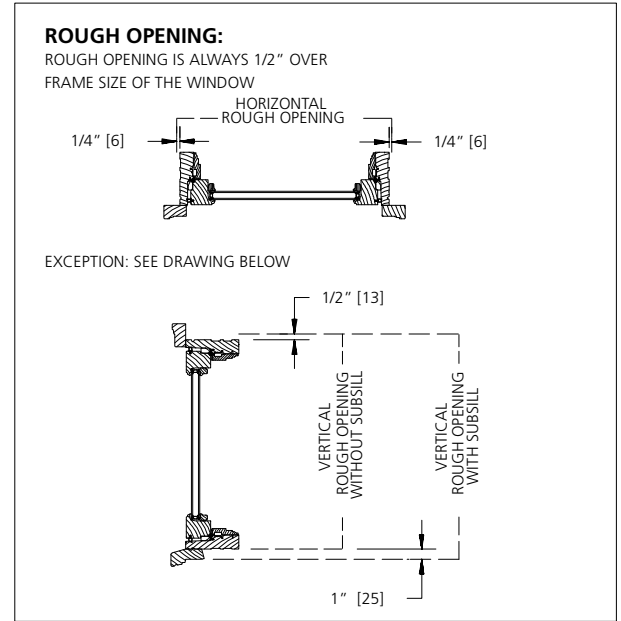

1-WIDE UNIT

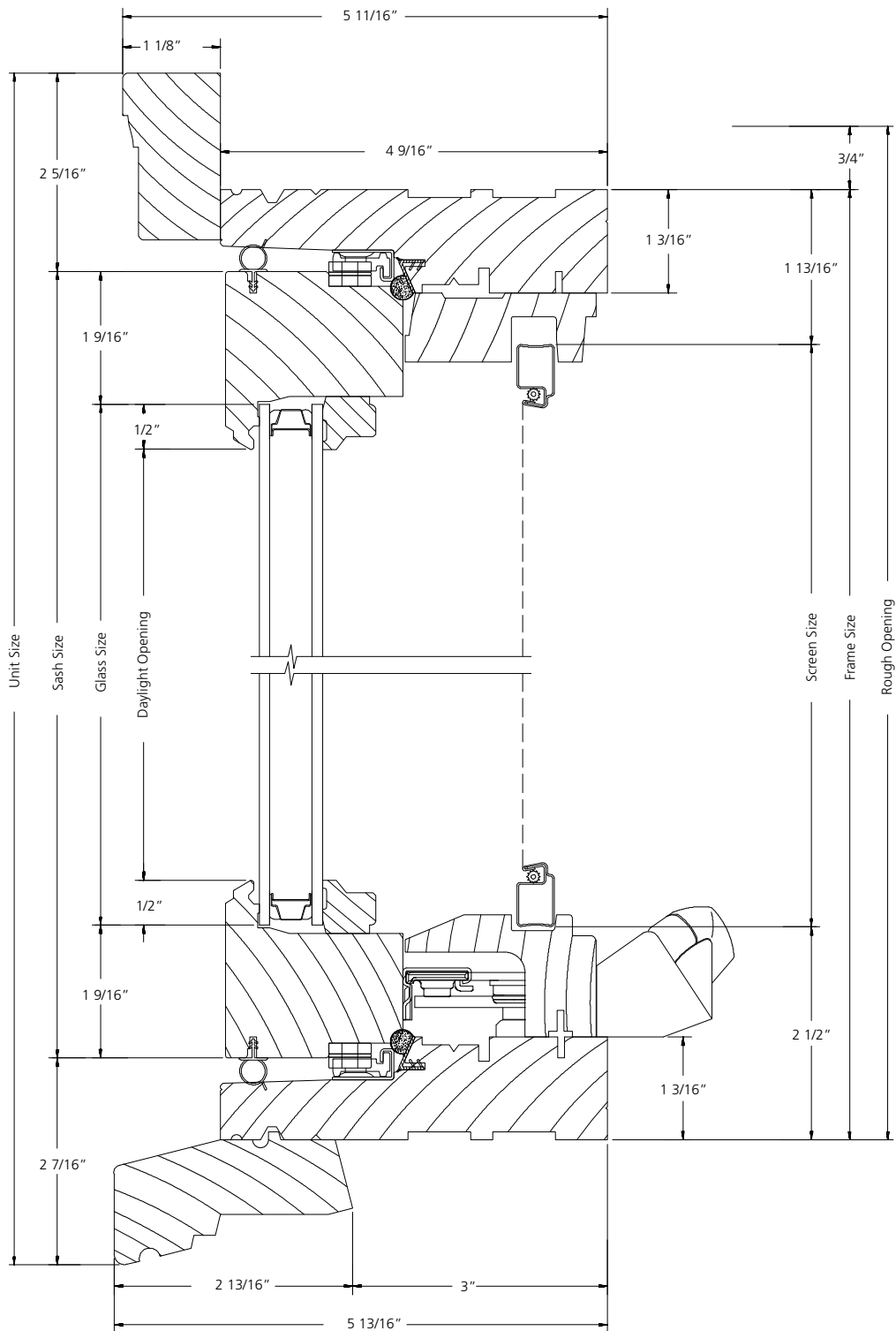

VERTICAL SECTION

SCALE: 6" = 1'

1-WIDE UNIT

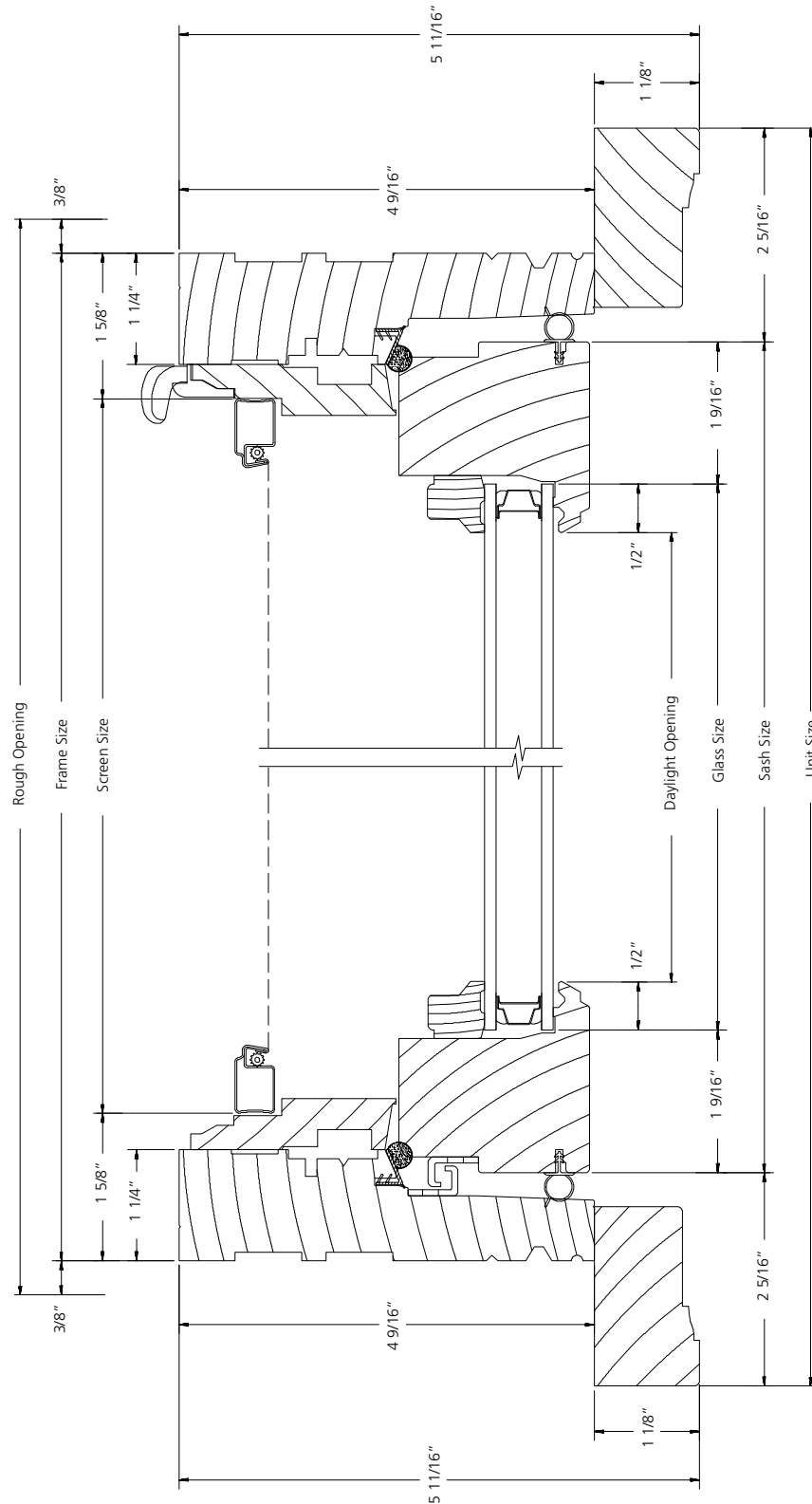

HORIZONTAL SECTION

SCALE: 6" = 1'

PICTURE UNIT

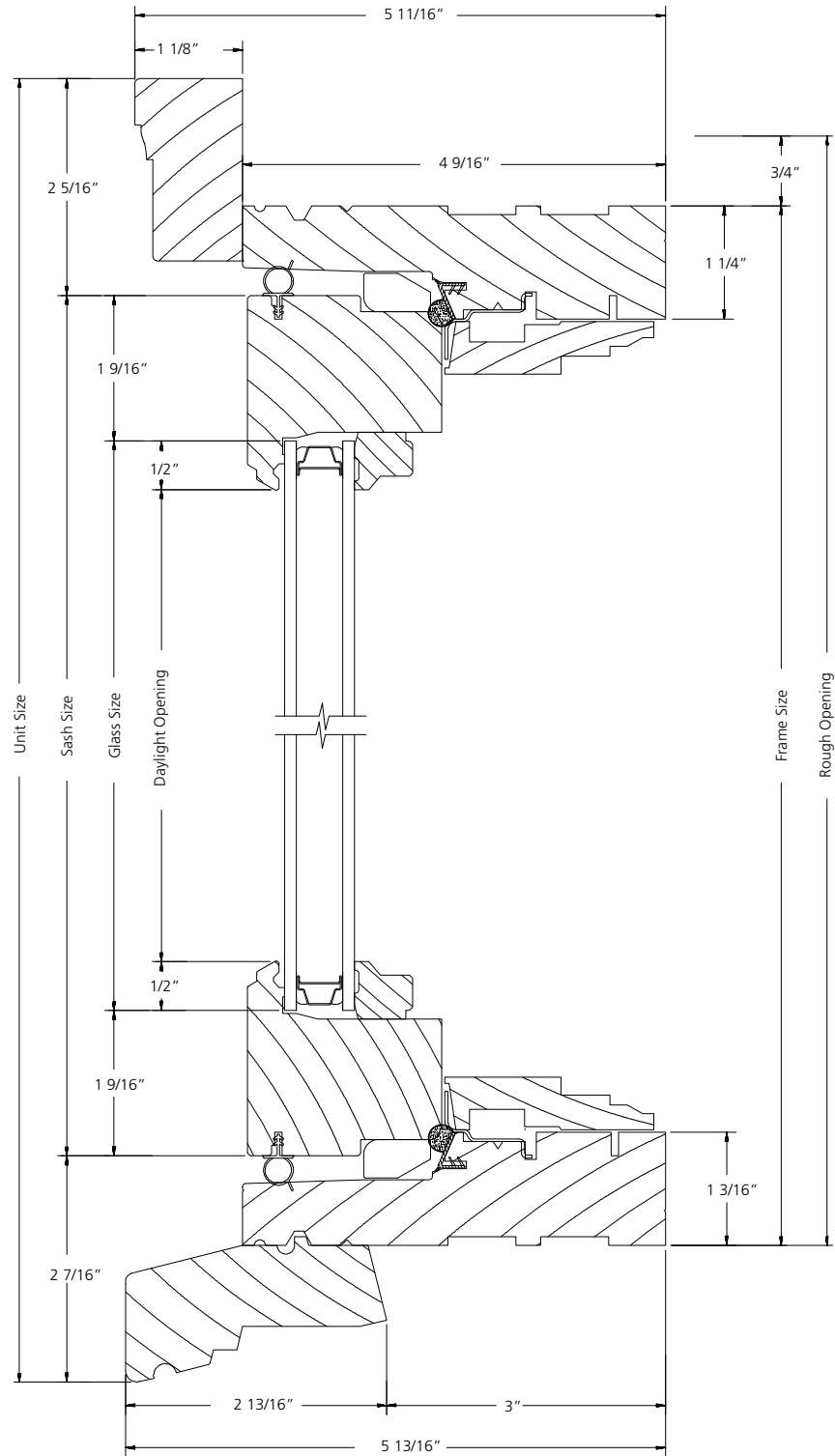

VERTICAL SECTION

SCALE: 6" = 1'

PICTURE UNIT

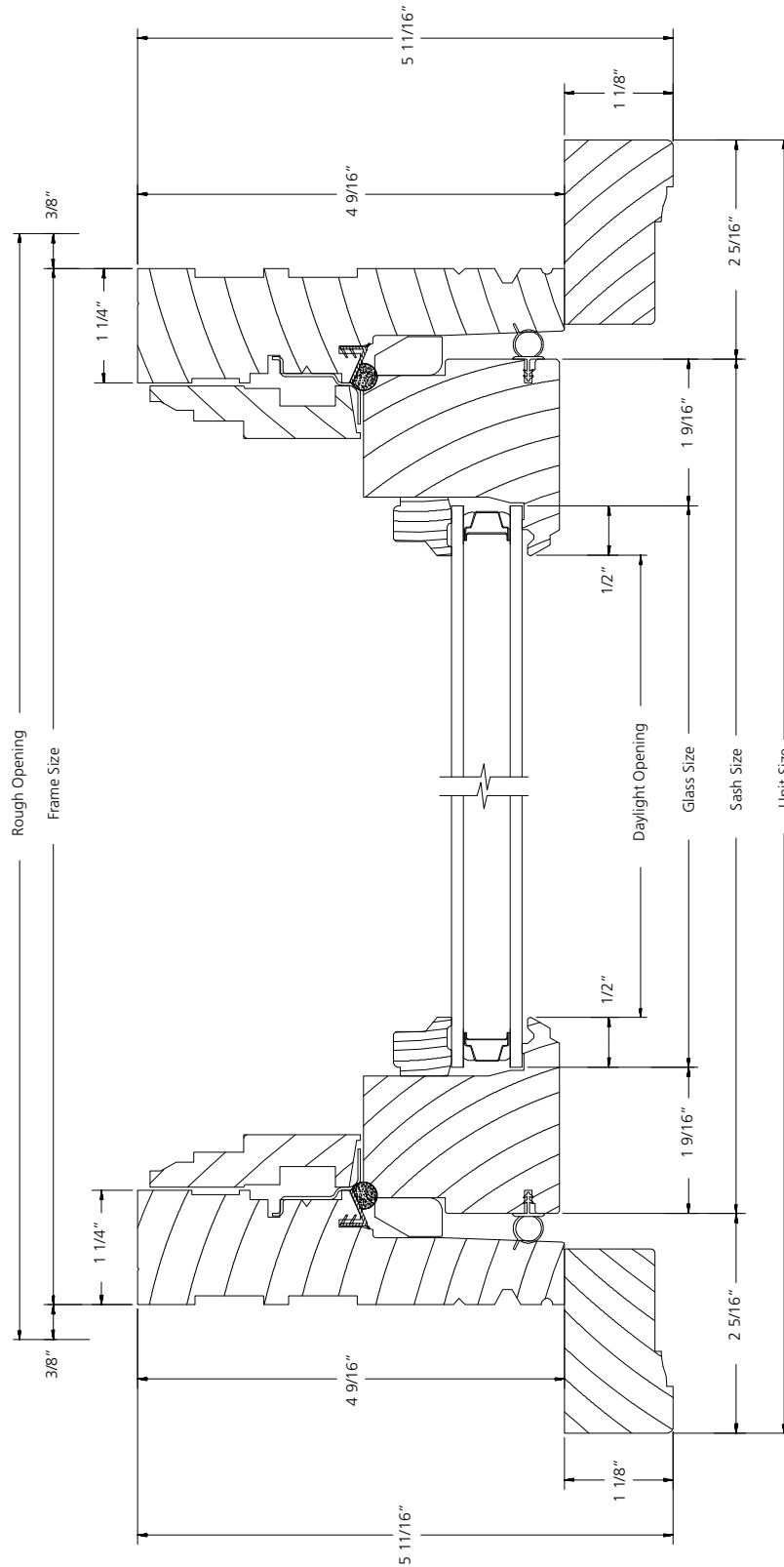

HORIZONTAL SECTION

SCALE: 6" = 1'

SECTOR TOP

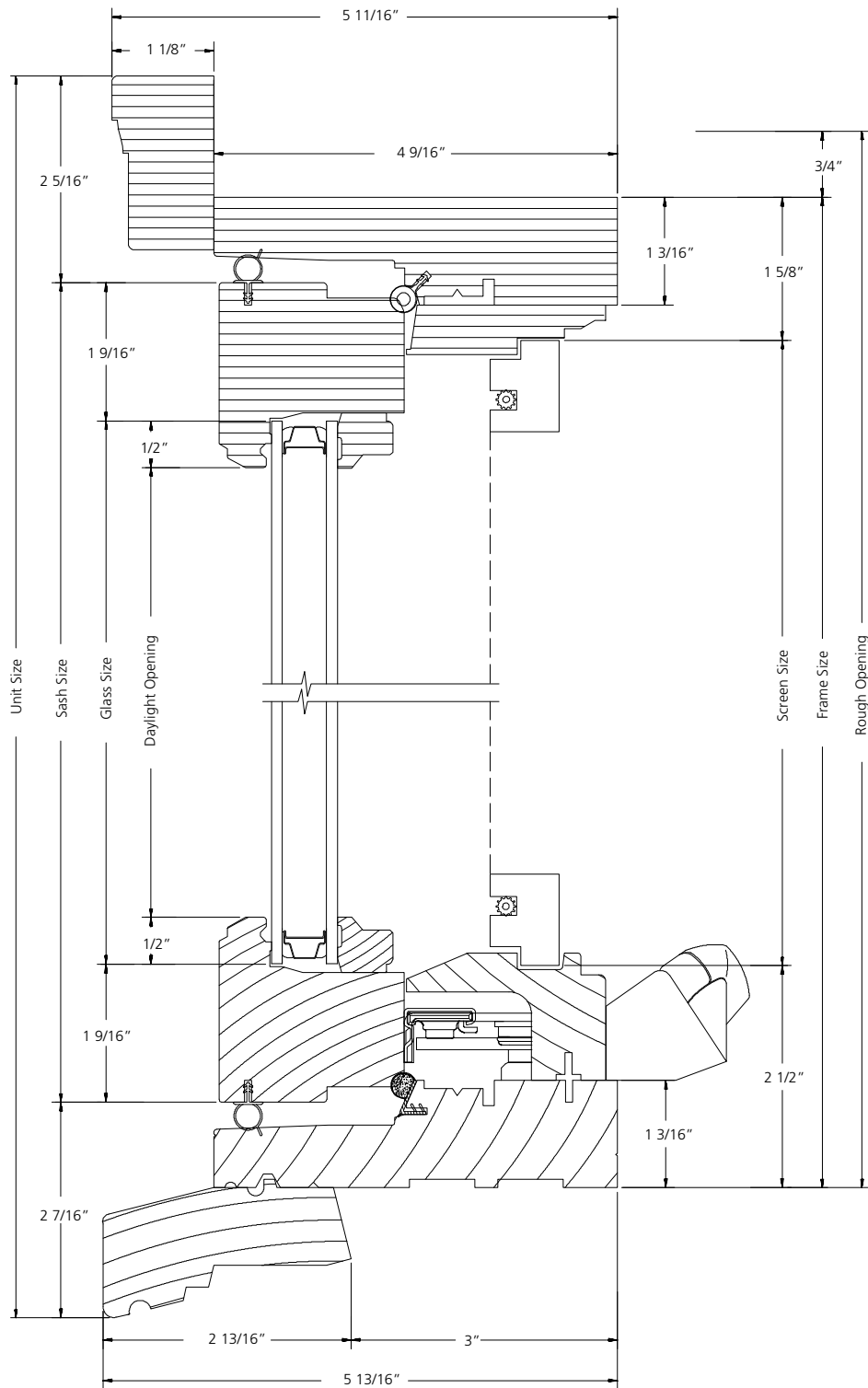

VERTICAL SECTION

SCALE: 6" = 1'

SECTOR TOP

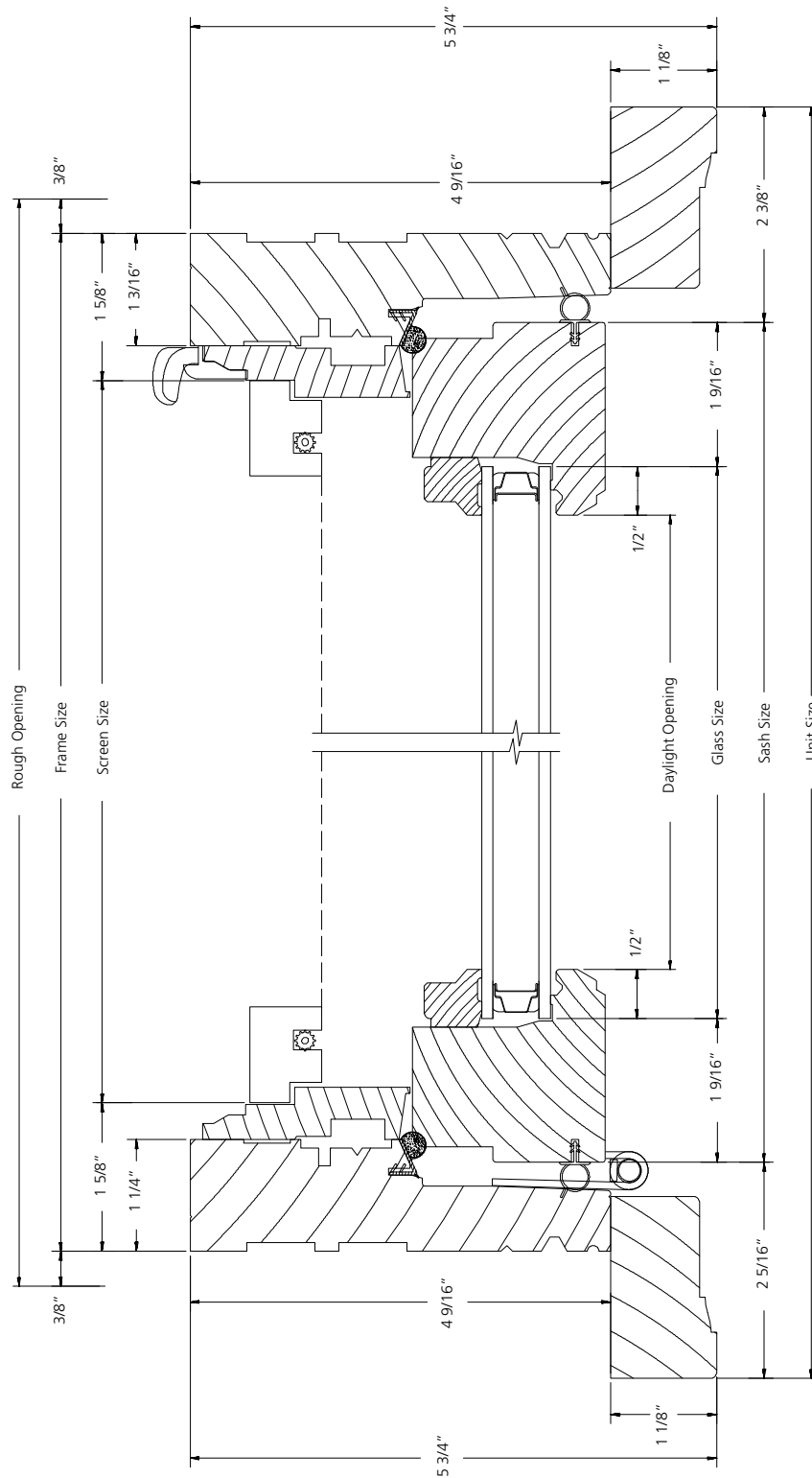

HORIZONTAL SECTION

SCALE: 6" = 1'

EXTENDED HALF ROUND

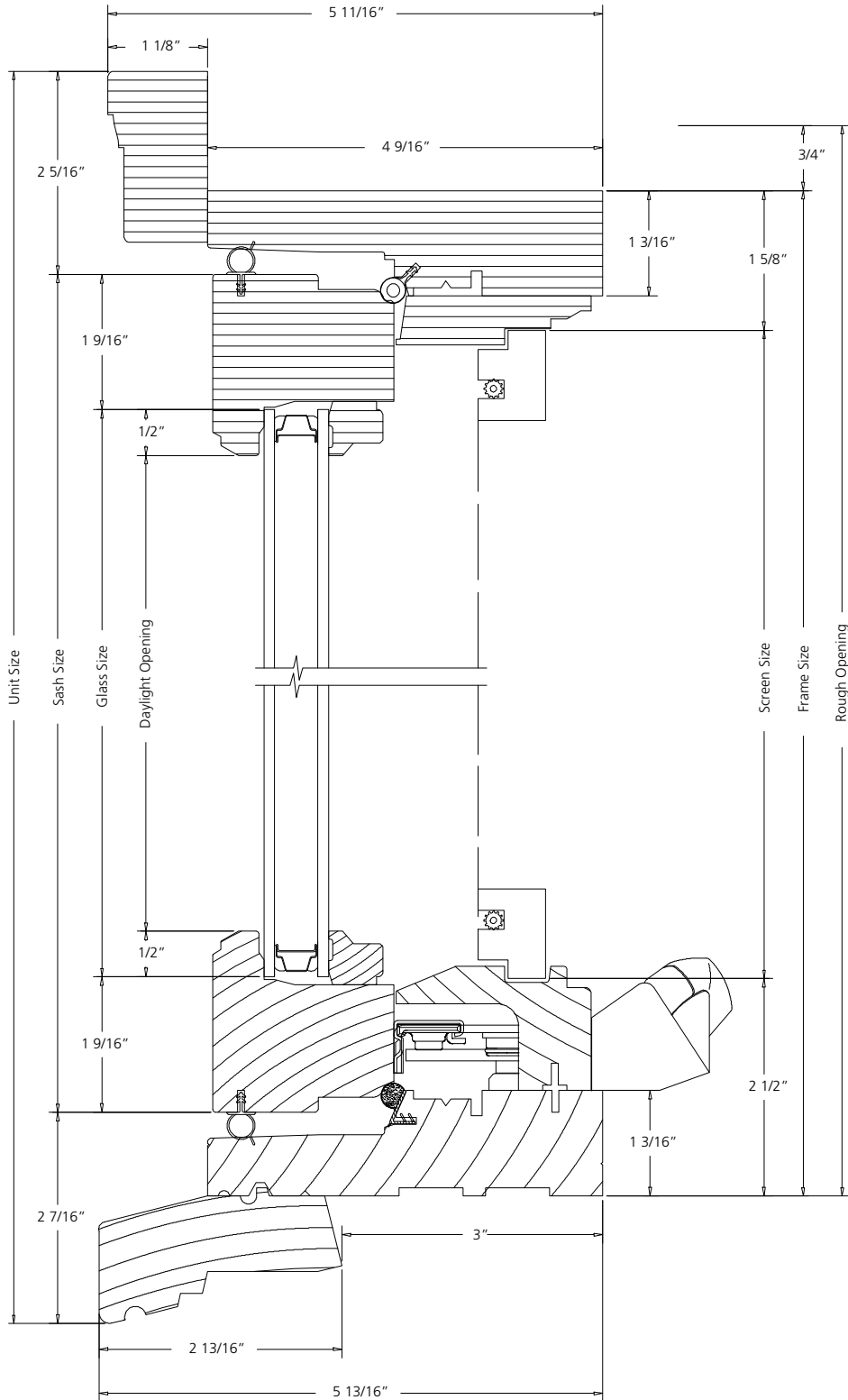

VERTICAL SECTION

SCALE: 6" = 1'

EXTENDED HALF ROUND

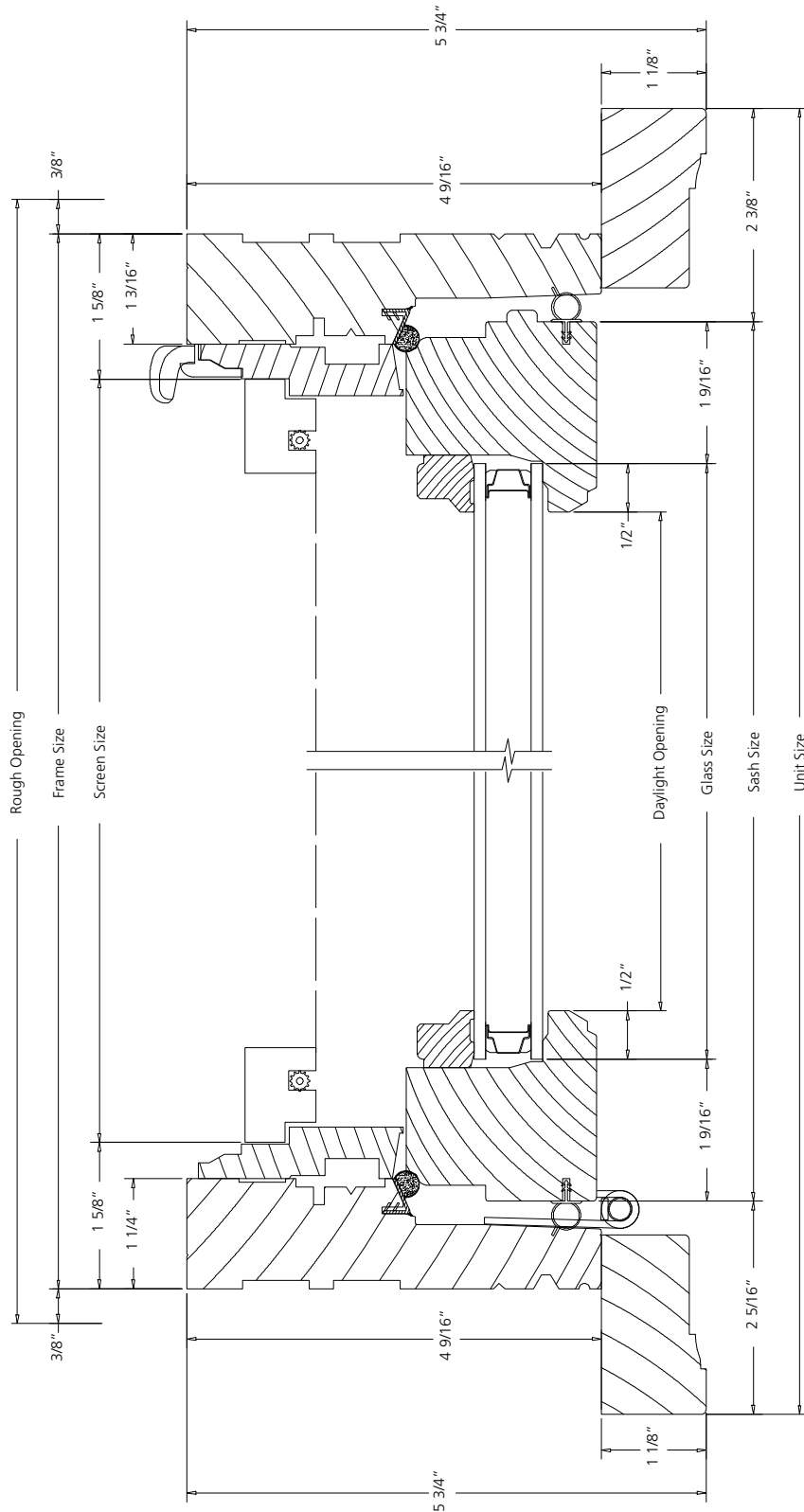

HORIZONTAL SECTION

SCALE: 6" = 1'

EXTENDED QUARTER ROUND

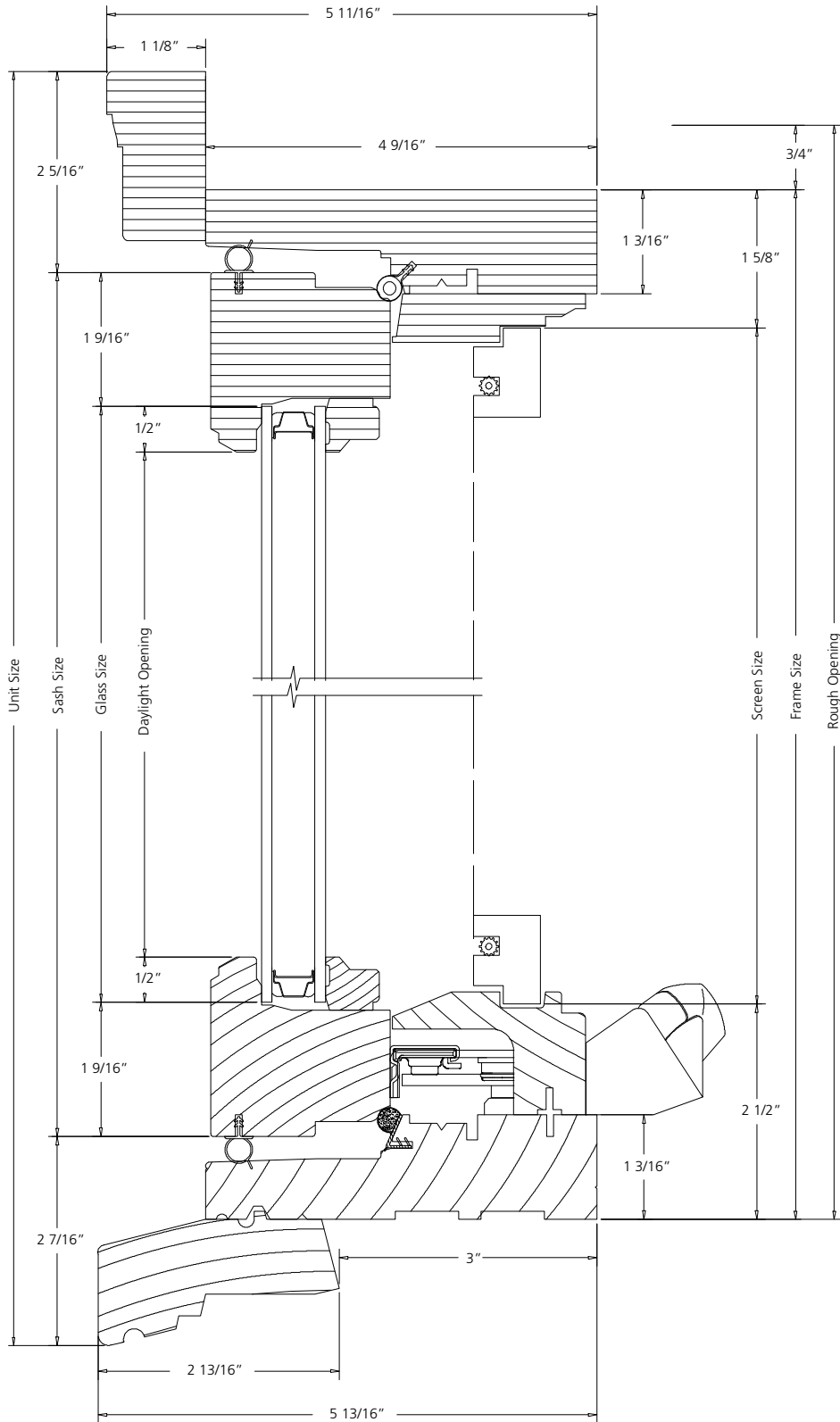

VERTICAL SECTION

SCALE: 6" = 1'

EXTENDED QUARTER ROUND

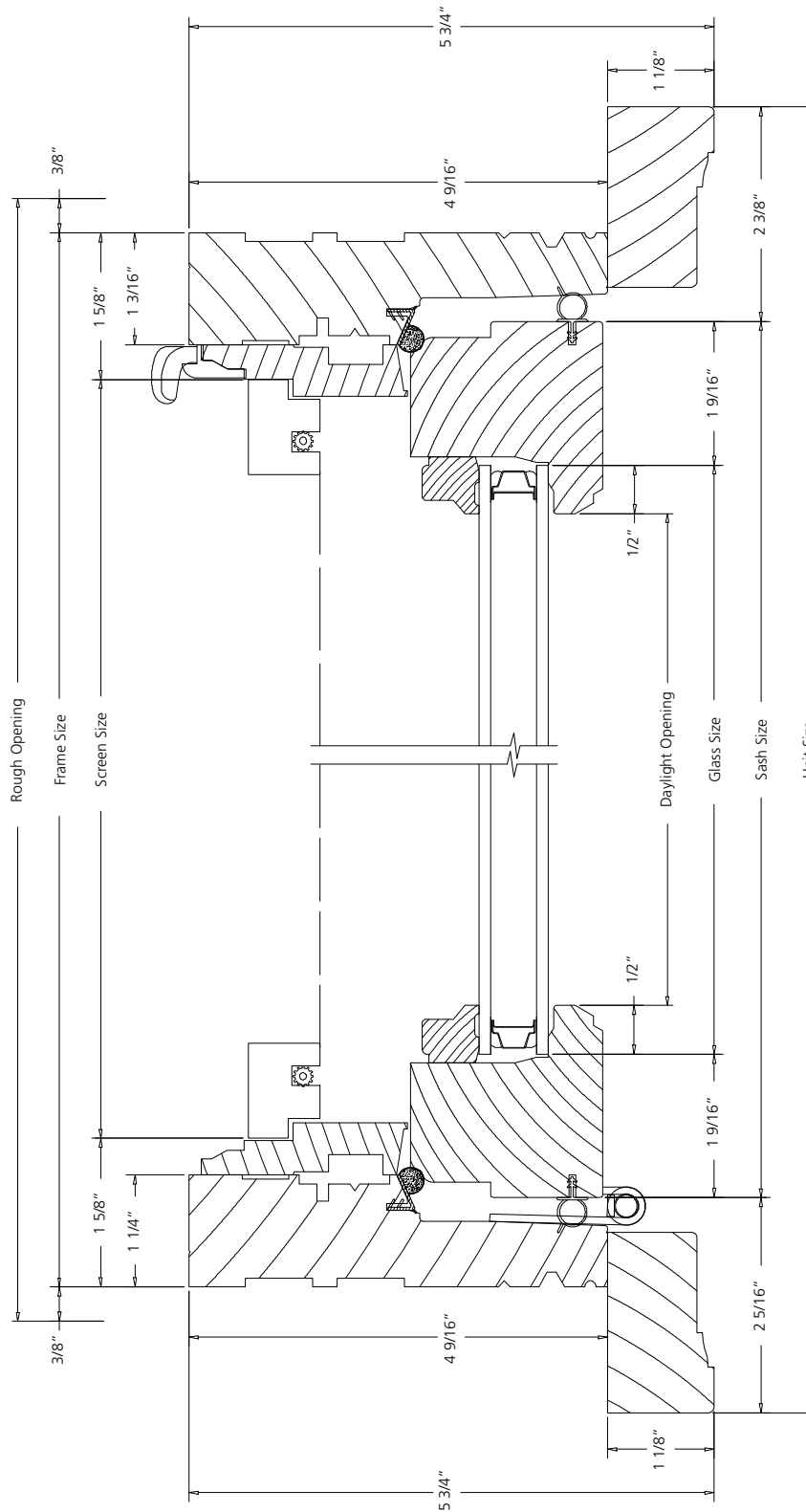

HORIZONTAL SECTION

SCALE: 6" = 1'