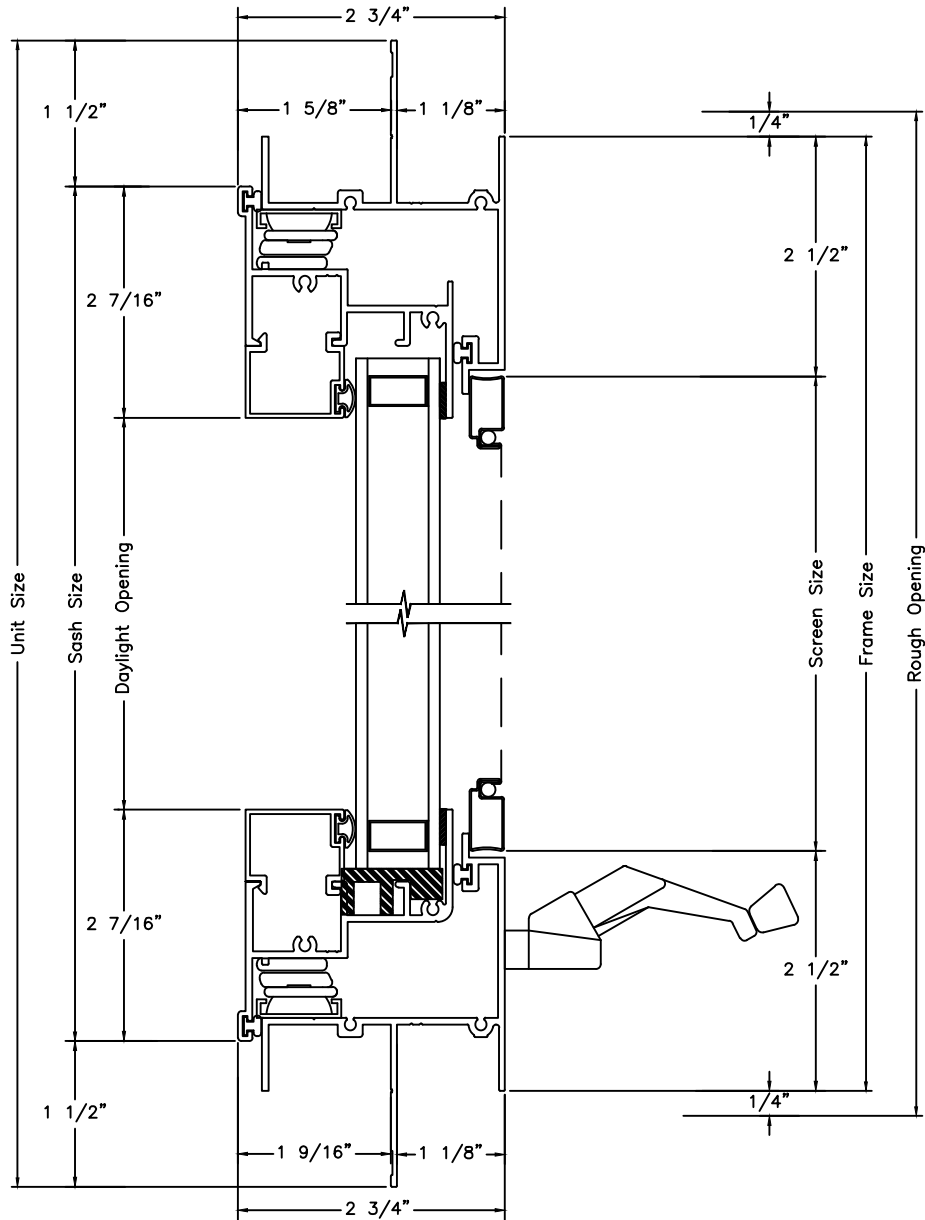
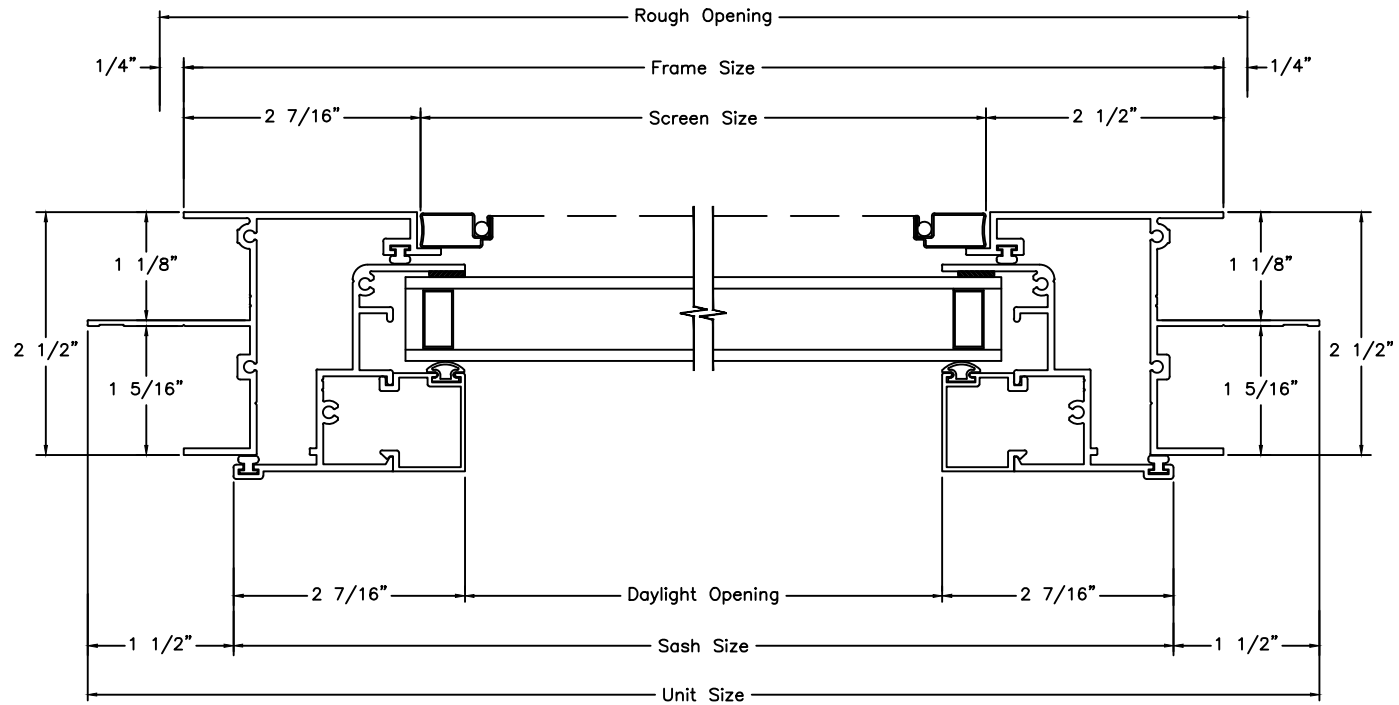

TABLE OF CONTENTS

Table of Contents	1
Premium Aluminum Sections	2-5
Vertical Section	2
Horizontal Section	3
Stationary Casement Vertical Section	4
Stationary Casement Horizontal Section	5
Elevations	6-14
Single Unit	6
Stationary Unit	8
3 Wide Unit	14

VERTICAL SECTION



HORIZONTAL SECTION



STATIONARY CASEMENT
VERTICAL SECTION

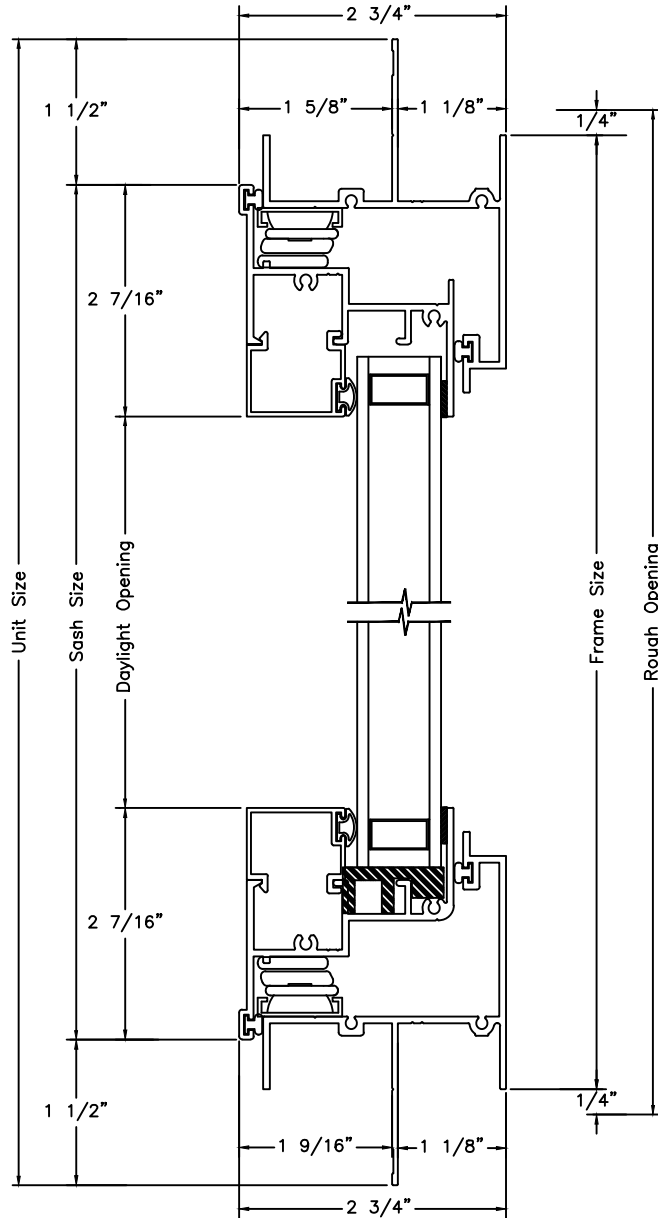



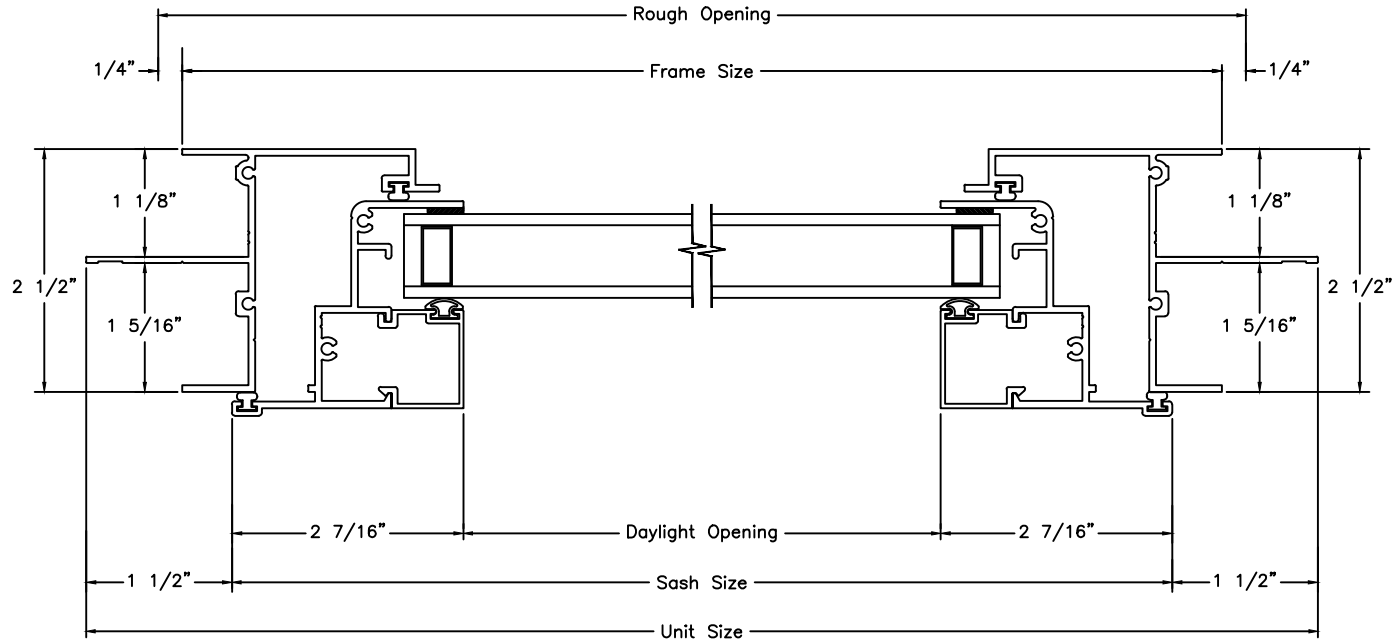

STATIONARY CASEMENT
HORIZONTAL SECTION

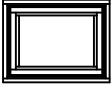

SINGLE UNIT ELEVATIONS

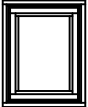
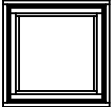
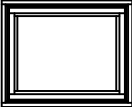
UNIT SIZE	20 5/8"(524)	26 5/8"(676)	32 5/8"(829)	38 5/8"(981)
ROUGH OPENING	18"(457)	24"(610)	30"(762)	36"(914)
FRAME SIZE	17 1/2"(445)	23 1/2"(597)	29 1/2"(749)	35 1/2"(902)
DAYLIGHT OPENING	12 3/4"(324)	18 3/4"(476)	24 3/4"(629)	30 3/4"(781)

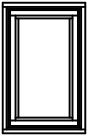
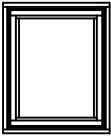
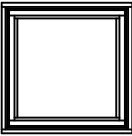
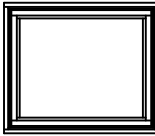
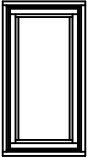
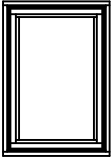
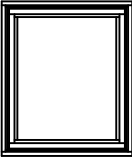
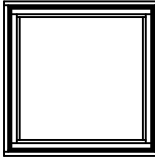
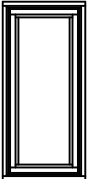
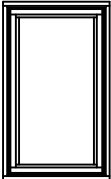
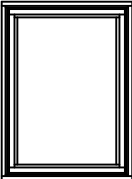
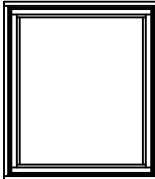
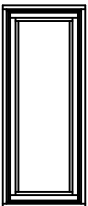
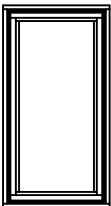
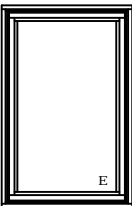
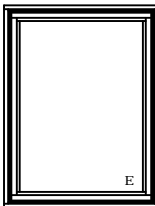
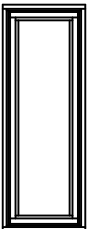
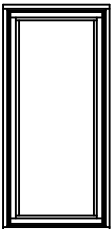
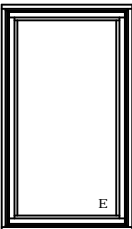
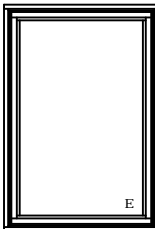
20 5/8"(524) 18"(457) 17 1/2"(445) 12 3/4"(324)				
	1616	2016	2616	3016
26 5/8"(676) 24"(610) 23 1/2"(597) 18 3/4"(476)				
	1620	2020	2620	3020
32 5/8"(829) 30"(762) 29 1/2"(749) 24 3/4"(629)				
	1626	2026	2626	3026
38 5/8"(981) 36"(914) 35 1/2"(902) 30 3/4"(781)				
	1630	2030	2630	3030
44 5/8"(1133) 42"(1067) 41 1/2"(1064) 36 3/4"(933)				
	1636	2036	2636	3036
50 5/8"(1286) 48"(1219) 47 1/2"(1207) 42 3/4"(1086)			 E	 E
	1640	2040	2640	3040
56 5/8"(1438) 54"(1372) 53 1/2"(1369) 48 3/4"(1238)			 E	 E
	1646	2046	2646	3046

ELEVATION SYMBOL LEGEND:

VALUES IN () ARE IN MILLIMETER CONVERSIONS.
E BASIC UNIT CLEAR OPENING EXCEEDS 20" IN WIDTH, 24" IN HEIGHT & A MINIMUM OF 5.7 SQ. FT.







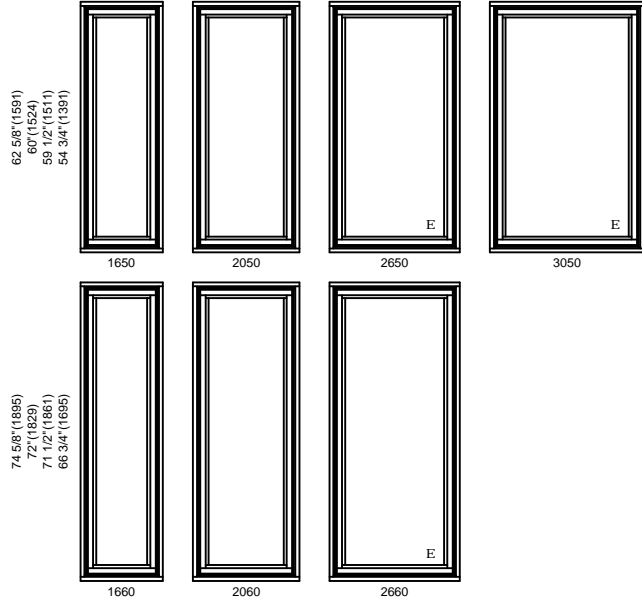



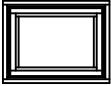
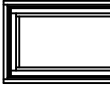

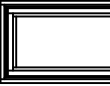





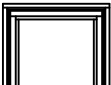



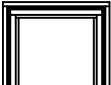



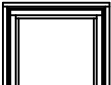



Note: Elevations shown DO NOT have exterior trim. Subtract 1/2"(12.7) from M.O.(Masonry Opening) for Unit Sizes. Masonry openings above include Sill Nose, see Trim Options page for Sill Nose specifications. For other Trim Options refer to the Unit Sizing, Rough Opening & Masonry Openings page.

SINGLE UNIT ELEVATIONS

UNIT SIZE	20 5/8"(524)	26 5/8"(676)	32 5/8"(829)	38 5/8"(981)
ROUGH OPENING	18"(457)	24"(610)	30"(762)	36"(914)
FRAME SIZE	17 1/2"(445)	23 1/2"(597)	29 1/2"(749)	35 1/2"(902)
DAYLIGHT OPENING	12 3/4"(324)	18 3/4"(476)	24 3/4"(629)	30 3/4"(781)



STATIONARY UNIT ELEVATIONS

UNIT SIZE	26 5/8"(676)	32 5/8"(829)	38 5/8"(981)	50 5/8"(1286)	62 5/8"(1591)
ROUGH OPENING	24"(610)	30"(762)	36"(914)	48"(1219)	60"(1524)
FRAME SIZE	23 1/2"(597)	29 1/2"(749)	35 1/2"(902)	47 1/2"(1207)	59 1/2"(1511)
DAYLIGHT OPENING	18 3/4"(476)	24 3/4"(629)	30 3/4"(781)	42 3/4"(1086)	54 3/4"(1391)
20 5/8"(524) 18"(457) 17 1/2"(445) 12 3/4"(324)					
	2016	2616	3016	4016	5016
26 5/8"(676) 24"(610) 23 1/2"(597) 18 3/4"(476)					
	2020	2620	3020	4020	5020
32 5/8"(829) 30"(762) 29 1/2"(749) 24 3/4"(629)					
	2026	2626	3026	4026	5026
38 5/8"(981) 36"(914) 35 1/2"(902) 30 3/4"(781)					
	2030	2630	3030	4030	5030
44 5/8"(1133) 42"(1067) 41 1/2"(1054) 36 3/4"(933)					
	2036	2636	3036	4036	5036
50 5/8"(1286) 48"(1219) 47 1/2"(1207) 42 3/4"(1086)					
	2040	2640	3040	4040	5040
56 5/8"(1438) 54"(1372) 53 1/2"(1359) 48 3/4"(1238)					
	2046	2646	3046	4046	5046

ELEVATION SYMBOL LEGEND:
VALUES IN () ARE IN MILLIMETER CONVERSIONS.

Note: Elevations shown DO NOT have exterior trim. Subtract 1/2"(12.7) from M.O.(Masonry Opening) for Unit Sizes. Masonry openings above include Sill Nose, see Trim Options page for Sill Nose specifications. For other Trim Options refer to the Unit Sizing, Rough Opening & Masonry Openings page.

STATIONARY UNIT ELEVATIONS

UNIT SIZE
ROUGH OPENING
FRAME SIZE
DAYLIGHT OPENING

26 5/8"(676)
24"(610)
23 1/2"(597)
18 3/4"(476)

32 5/8"(829)
30"(762)
29 1/2"(749)
24 3/4"(629)

38 5/8"(981)
36"(914)
35 1/2"(902)
30 3/4"(781)

50 5/8"(1286)
48"(1219)
47 1/2"(1207)
42 3/4"(1086)

62 5/8"(1591)
60"(1524)
59 1/2"(1511)
54 3/4"(1391)

62 5/8"(1591)
60"(1524)
59 1/2"(1511)
54 3/4"(1391)

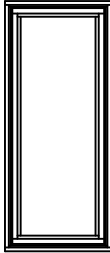

2050

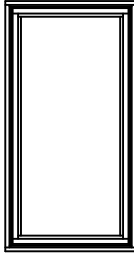

2650

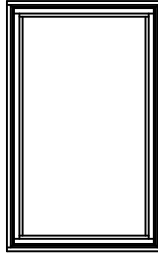

3050

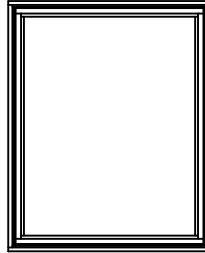

4050

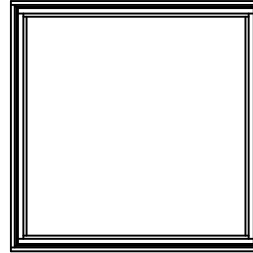

5050

74 5/8"(1895)
72"(1829)
71 1/2"(1861)
66 3/4"(1695)

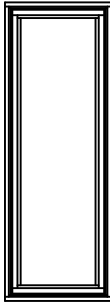

2060

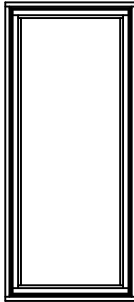

2660

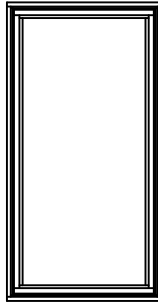

3060

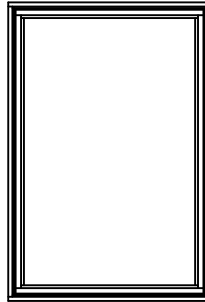

4060

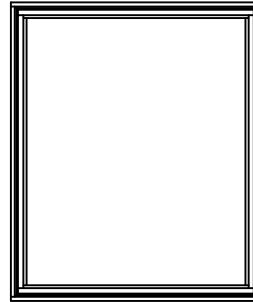

5060

86 5/8"(2200)
84"(2134)
83 1/2"(2121)
78 3/4"(2000)

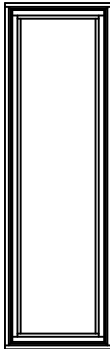

2070

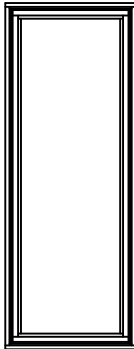

2670

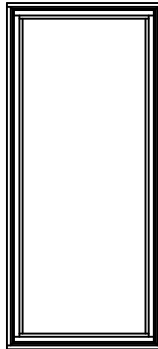

3070

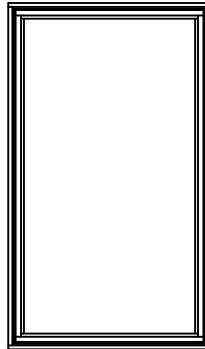

4070

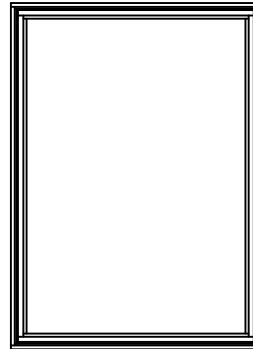

5070

98 5/8"(2505)
96"(2438)
95 1/2"(2426)
90 3/4"(2305)

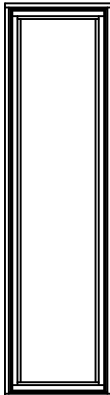

2080

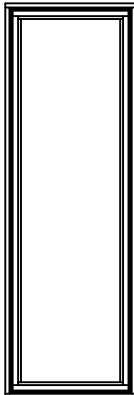

2680

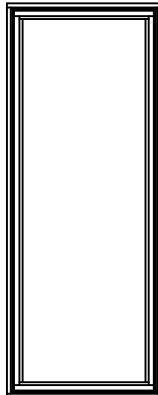

3080

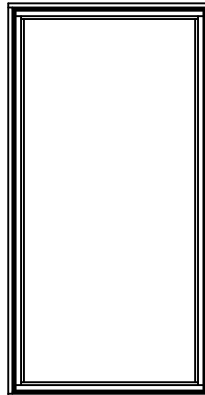

4080

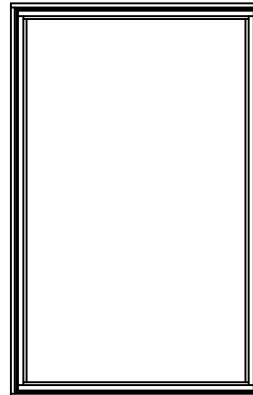

5080

STATIONARY UNIT ELEVATIONS

UNIT SIZE	26 5/8"(676)	32 5/8"(829)	38 5/8"(981)	50 5/8"(1286)
ROUGH OPENING	24"(610)	30"(762)	36"(914)	48"(1219)
FRAME SIZE	23 1/2"(597)	29 1/2"(749)	35 1/2"(902)	47 1/2"(1207)
DAYLIGHT OPENING	18 3/4"(476)	24 3/4"(629)	30 3/4"(781)	42 3/4"(1086)

110 5/8"(2810)
108"(2743)
107 1/2"(2731)
102 3/4"(2610)

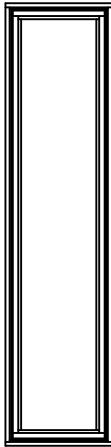

2090

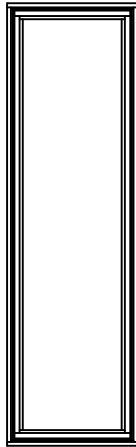

2690

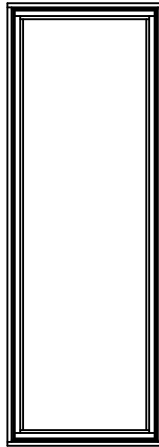

3090

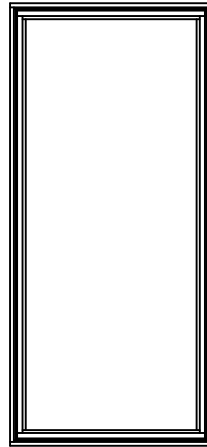

4090

122 5/8"(3115)
120"(3048)
119 1/2"(3035)
114 3/4"(2915)

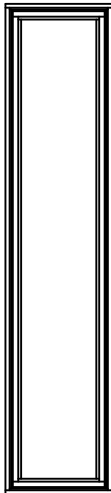

2010

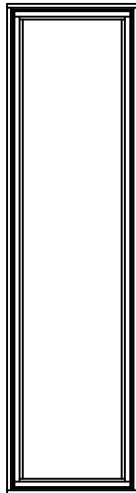

2610

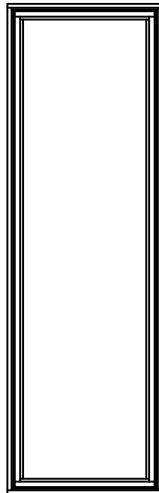

3010

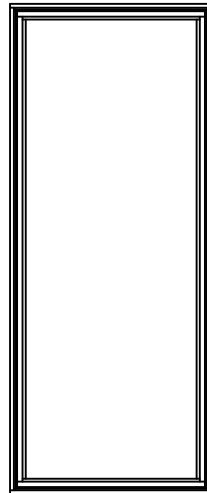

4010

STATIONARY UNIT ELEVATIONS

UNIT SIZE
ROUGH OPENING
FRAME SIZE
DAYLIGHT OPENING

74 5/8"(1895)
72"(1829)
71 1/2"(1861)
66 3/4"(1695)

86 5/8"(2200)
84"(2134)
83 1/2"(2121)
78 3/4"(2000)

98 5/8"(2505)
96"(2438)
95 1/2"(2426)
90 3/4"(2305)

20 5/8"(524)
18"(457)
17 1/2"(445)
12 3/4"(324)



6016



7016



8016

26 5/8"(676)
24"(610)
23 1/2"(597)
18 3/4"(476)



6020



7020



8020

32 5/8"(829)
30"(762)
29 1/2"(749)
24 3/4"(629)



6026



7026



8026

38 5/8"(981)
36"(914)
35 1/2"(902)
30 3/4"(781)



6030



7030



8030

44 5/8"(1133)
42"(1067)
41 1/2"(1054)
36 3/4"(933)



6036



7036



8036

50 5/8"(1286)
48"(1219)
47 1/2"(1207)
42 3/4"(1086)

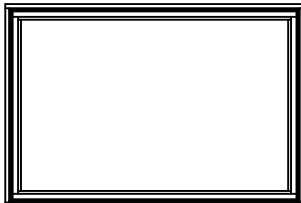

6040

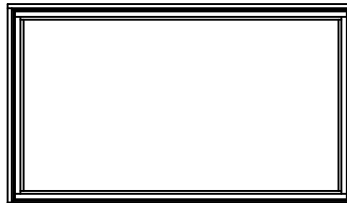

7040

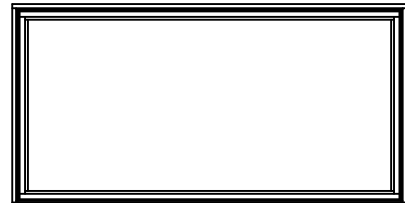

8040

56 5/8"(1438)
54"(1372)
53 1/2"(1359)
48 3/4"(1238)

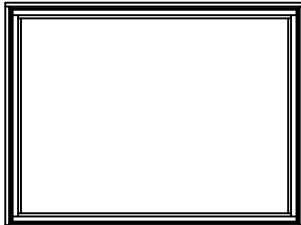

6046

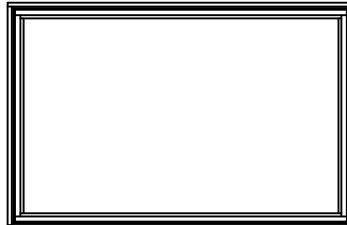

7046

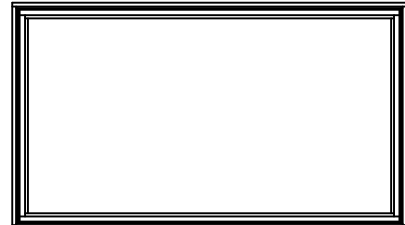

8046

62 5/8"(1591)
60"(1524)
59 1/2"(1511)
54 3/4"(1391)

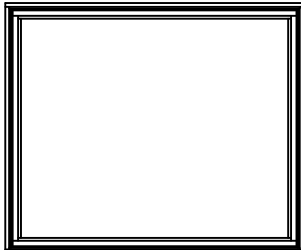

6050

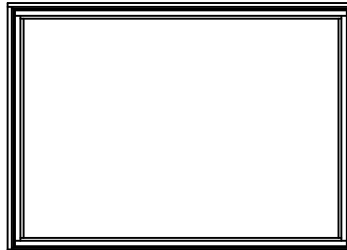

7050

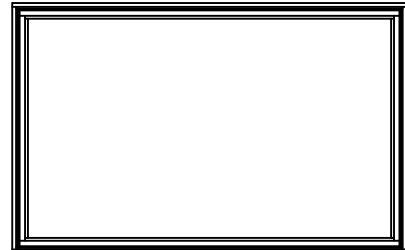

8050

STATIONARY UNIT ELEVATIONS

UNIT SIZE	74 5/8" (1895)
ROUGH OPENING	72" (1829)
FRAME SIZE	71 1/2" (1861)
DAYLIGHT OPENING	68 3/4" (1695)

74 5/8" (1895)
72" (1829)
71 1/2" (1861)
68 3/4" (1695)

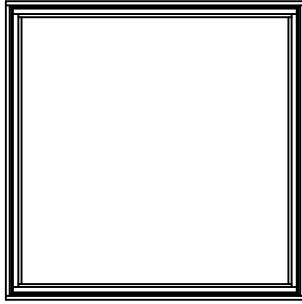

6060

STATIONARY UNIT ELEVATIONS

UNIT SIZE
ROUGH OPENING
FRAME SIZE
DAYLIGHT OPENING

110 5/8"(2810)
108"(2743)
107 1/2"(2731)
102 3/4"(2610)

122 5/8"(3115)
120"(3048)
119 1/2"(3035)
114 3/4"(2915)

20 5/8"(524)
19"(487)
17 1/2"(446)
12 3/4"(324)



9016



10016

26 5/8"(676)
24"(610)
23 1/2"(597)
18 3/4"(476)



9020



10020

32 5/8"(829)
30"(762)
29 1/2"(749)
24 3/4"(629)



9026



10026

38 5/8"(981)
36"(914)
35 1/2"(902)
30 3/4"(781)

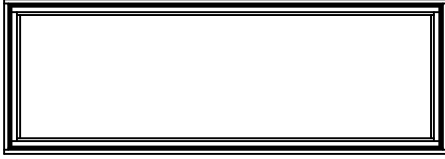

9030

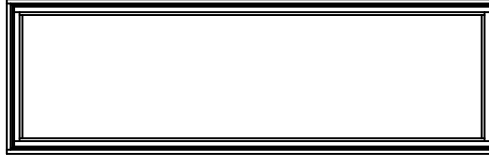

10030

44 5/8"(1133)
42"(1067)
41 1/2"(1054)
36 3/4"(933)



9036



10036

50 5/8"(1286)
48"(1219)
47 1/2"(1207)
42 3/4"(1086)

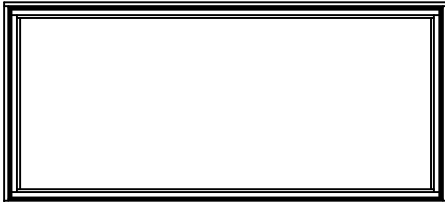

9040

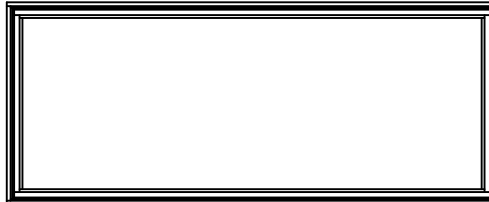

10040

3 WIDE UNIT ELEVATIONS

UNIT SIZE ROUGH OPENING FRAME SIZE DAYLIGHT OPENING	74 7/8"(1902) 72"(1829) 71 1/2"(1861) 18 3/4"(476)[2] 18 1/16"(459)	98 7/8"(2511) 96"(2438) 95 1/2"(2426) 18 3/4"(476)[2] 42 1/16"(1068)	122 7/8"(3121) 120"(3048) 119 1/2"(3035) 18 3/4"(476)[2] 54 1/16"(1373)
20 7/8"(530) 18"(457) 17 1/2"(445) 13"(330)			
26 7/8"(683) 24 1/2"(610) 23 1/2"(597) 19 1/4"(483)			
32 7/8"(835) 30 1/2"(762) 29 1/2"(749) 25"(635)			
38 7/8"(987) 36 1/2"(914) 35 1/2"(902) 31 1/4"(787)			
44 7/8"(1140) 42 1/2"(1067) 41 1/2"(1054) 37 1/4"(940)			
50 7/8"(1292) 48 1/2"(1219) 47 1/2"(1207) 43 1/4"(1092)			
56 7/8"(1445) 54 1/2"(1372) 53 1/2"(1359) 49 1/4"(1245)			
62 7/8"(1597) 60 1/2"(1524) 59 1/2"(1511) 55 1/4"(1397)			
74 7/8"(1902) 72"(1829) 71 1/2"(1861) 67"(1702)			

ELEVATION SYMBOL LEGEND:
VALUES IN () ARE IN MILLIMETER CONVERSIONS.
E BASIC UNIT CLEAR OPENING EXCEEDS 20" IN WIDTH, 24" IN HEIGHT & A MINIMUM OF 5.7 SQ. FT.

Note: Elevations shown DO NOT have exterior trim. Subtract 1/2"(12.7) from M.O.(Masonry Opening) for Unit Sizes. Masonry openings above include Sill Nose, see Trim Options page for Sill Nose specifications. For other Trim Options refer to the Unit Sizing, Rough Opening & Masonry Openings page.