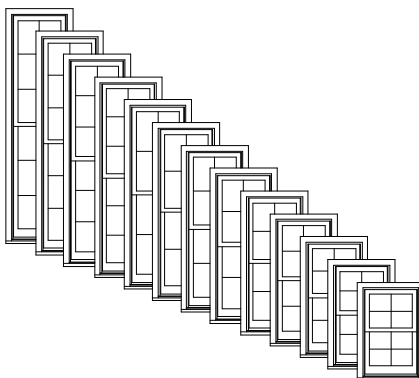

TABLE OF CONTENTS

Elevations/Sizes: 1/4" Scale	6-2
1-Wide Units	6-5
2-Wide Units	6-8
3-Wide Units	6-10
Picture Units	6-14
Picture Units with Flankers	6-23
Angle Bay Units with Flankers	6-26
Transom Units	6-32
Glazing Options: 3" Scale	6-35
Trim Options: 3" Scale	6-36
Jamb Extender Options: 3" Scale	6-37
Standard Mullion Options	6-38
Lite Cut Information & Options	6-40
Unit Sizing, Rough Openings & Masonry Openings	6-42
Section Details: 6" Scale	
Standard Units	6-43
Pocket Units	6-52
Angle Bay Rough Opening Information	6-58
Section Details: 6" Scale (Angle Bay)	6-59

GENERAL INFORMATION
DOUBLE-HUNG



DIMENSIONAL WINDOWS

Wood double hung windows may be specified as "dimensional", by adjusting the desired rough opening width or height in 1/8" increments from standard.

Wood double-hung windows feature fully operating upper and lower sash. Counterbalancing is achieved with block and tackle spring extension systems hidden in weatherable PVC jamb liners. Operating units are supplied with cam-type sash locks installed. Die-cast lower sash lifts supplied for field installation are an option. Recessed sash retainers provide simple sash installation and removal. There are several hardware finish options. Refer to the Specifications for available finish options.

MULTIPLE ASSEMBLIES

Wood double-hung windows may be mullied beside other wood double-hungs or wood picture windows, or below wood transom windows, to fulfill a wide variety of needs. Factory assembled mulls are limited in height (100"), width (114"), and a total area (75 square feet).

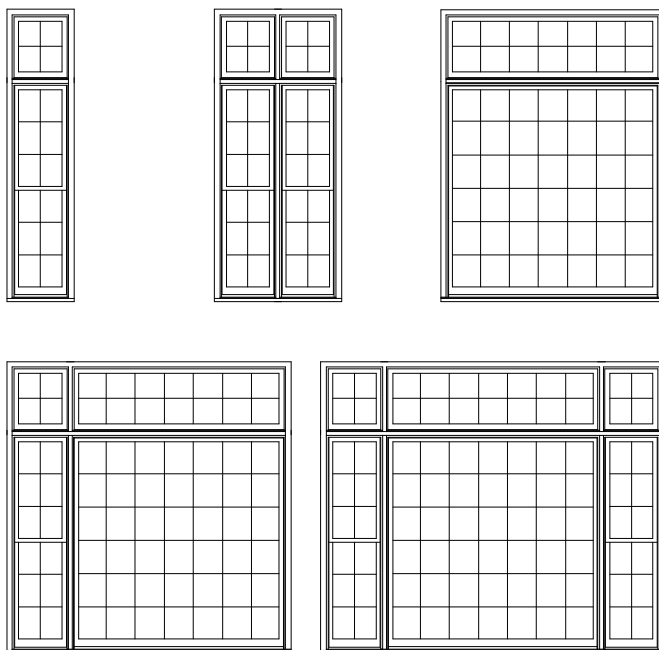

HANDING & OPERATION

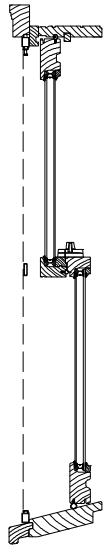

DOUBLE-HUNG OPERATION:
When the sash are locked at the check rails the sash are closed and sealed in the sash opening of the frame.

When the sash are unlocked the lower sash travels vertically to any position desired. The upper sash can also be positioned as desired.

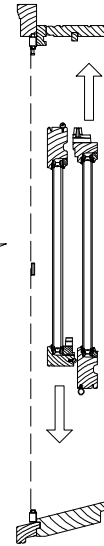

SASH TILTING FOR WASHING

The Tradition Plus Double Hung window will allow the sash to be tilted or removed for easy cleaning.

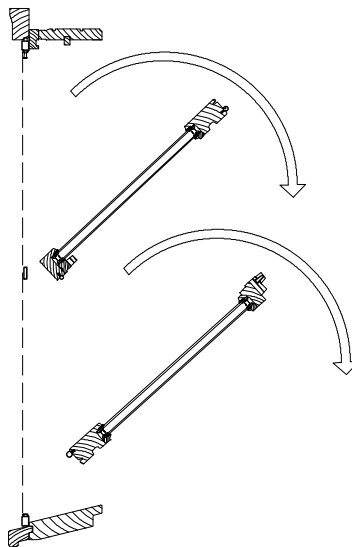

ELEVATION NOTES
DOUBLE-HUNG

ELEVATION DRAWINGS UTILIZE A LIMITED NUMBER OF PROJECTED LINES TO PRODUCE A RUDIMENTARY DRAWING INTENDED TO BE USED IN A SMALL GRAPHICAL SCALE. ELEVATIONS ARE VIEWED PERPENDICULAR FROM THE EXTERIOR OF THE STRUCTURE. IF MORE DIMENSIONS ARE NEEDED, USE THE SECTION DRAWINGS FOR MORE COMPLETE DEPICTIONS.

M.O. Brickmould
M.O. Adams/Flat Casing
Rough Opening
Frame Size
Daylight Opening

24 3/4"(629)
27 3/4"(705)
22 1/8"(562)
21 3/8"(543)
15"(381)

Masonry Openings for Brickmould, Flat & Adams Casing. Vertical measurements include sillnose. (Subtract 1/2" from Masonry Opening for Unit Size)

39"(991)
40 1/2"(1029)
37 1/4"(946)
36 1/2"(927)
13 9/16"(344)[2]

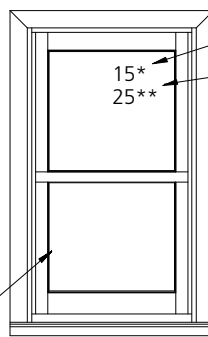

DP RATING

OPTIONAL DP RATING
SEE SYMBOL LEGEND BELOW

OUTSIDE OF
EXTERIOR TRIM

DAYLIGHT OPENING

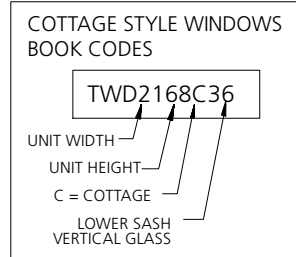

TWD2136

'TWD' INDICATES
TRADITION PLUS WOOD DOUBLE-HUNG

THE FIRST TWO NUMBERS
INDICATE THE UNIT WIDTH

BOOK CODE

THE LAST TWO NUMBERS INDICATE
THE UNIT HEIGHT

GENERAL WOOD DOUBLE-HUNG NOTES

1. ALL UNITS SHOWN ARE AVAILABLE AS OPERATORS ONLY.
2. UNIT ELEVATIONS ARE SHOWN WITH BRICKMOULD & SILL NOSE.
3. DIMENSIONAL VALUES IN PARENTHESES ARE MILLIMETER CONVERSIONS.
4. VALUES IN BRACKETS ARE NUMBER OF DAYLIGHT OPENINGS.

ELEVATION SYMBOL LEGEND:

- MO** MASONRY OPENING
- E** BASIC UNIT CLEAR OPENING EXCEEDS 20" IN WIDTH, 24" IN HEIGHT & A MINIMUM OF 5.7 SQ. FT.
- ##** NUMBER INDICATES DESIGN PRESSURE (DP) RATING WITH STANDARD GLAZING.
- ###** NUMBER INDICATES OPTIONAL DESIGN PRESSURE (DP) RATING.
- ++** TEMPERED GLASS, TINTED GLASS, OBSCURE GLASS AND/OR SDL OPTIONS REQUIRE A HEAVY DUTY JAMB LINER.

1-WIDE UNITS

M.O. BRICKMOULD
M.O. ADAMS/FLAT CASING
ROUGH OPENING
FRAME SIZE
DAYLIGHT OPENING

24 3/4" (629)
27 3/4" (705)
22 1/8" (562)
21 3/8" (543)
15" (381)

28 3/4" (730)
31 3/4" (806)
26 1/8" (664)
25 3/8" (645)
19" (483)

32 3/4" (832)
35 3/4" (908)
30 1/8" (765)
29 3/8" (746)
23" (584)

36 3/4" (933)
39 3/4" (1010)
34 1/8" (867)
33 3/8" (848)
27" (686)

40 3/4" (1035)
43 3/4" (1111)
38 1/8" (968)
37 3/8" (949)
31" (787)

44 3/4" (1137)
47 3/4" (1213)
42 1/8" (1070)
41 3/8" (1051)
35" (889)

48 3/4" (1238)
51 3/4" (1314)
46 1/8" (1172)
45 3/8" (1153)
39" (991)

39" (991)
40 1/2" (1029)
37 1/4" (946)
36 1/2" (927)
13 9/16" (344) [2]

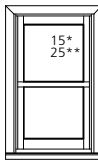

TWD2136

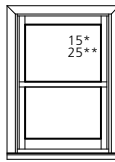

TWD2536

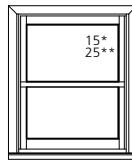

TWD2936

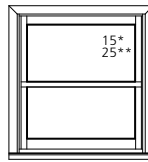

TWD3336

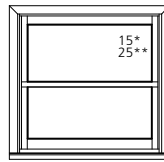

TWD3736

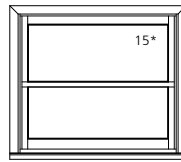

TWD4136

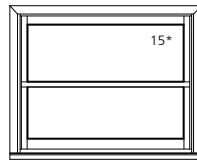

TWD4536

43" (1092)
44 1/2" (1130)
41 1/4" (1048)
40 1/2" (1029)
15 9/16" (395) [2]

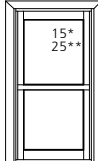

TWD2140

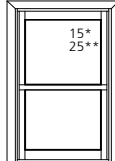

TWD2540

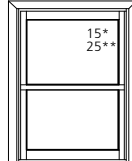

TWD2940

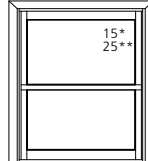

TWD3340

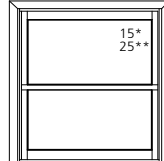

TWD3740

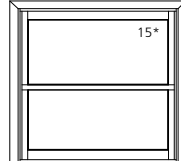

TWD4140

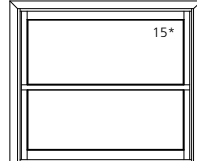

TWD4540

51" (1295)
52 1/2" (1334)
49 1/4" (1251)
48 1/2" (1232)
19 9/16" (497) [2]

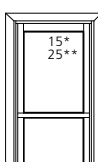

TWD2148

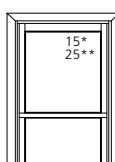

TWD2548

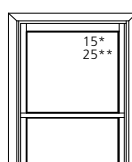

TWD2948

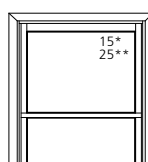

TWD3348

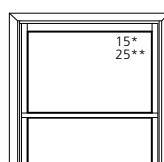

TWD3748

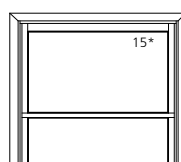

TWD4148

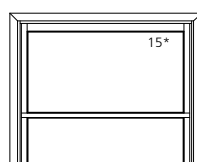

TWD4548

55" (1397)
56 1/2" (1435)
53 1/4" (1353)
52 1/2" (1334)
21 9/16" (547) [2]

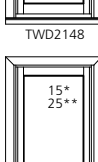

TWD2152

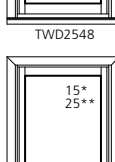

TWD2552

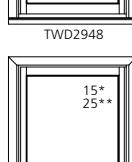

TWD2952

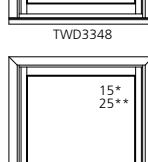

TWD3352

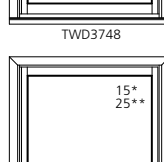

TWD3752

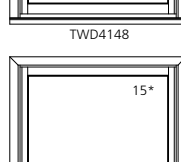

TWD4152

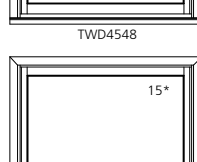

TWD4552

59" (1499)
60 1/2" (1537)
57 1/4" (1454)
56 1/2" (1435)
23 9/16" (598) [2]



TWD215*6



TWD255*6

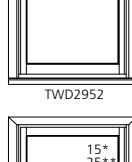

TWD295*6

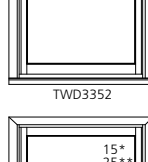

TWD335*6

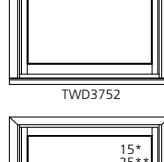

TWD375*6

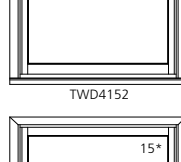

TWD415*6

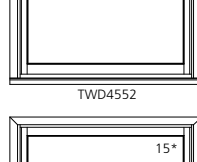

TWD455*6

63" (1600)
64 1/2" (1638)
61 1/4" (1556)
60 1/2" (1537)
25 9/16" (649) [2]

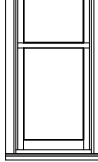

TWD2160

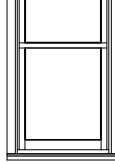

TWD2560

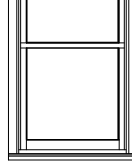

TWD2960

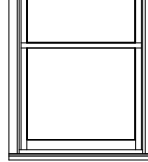

TWD3360

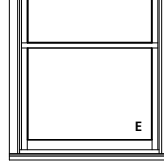

TWD3760

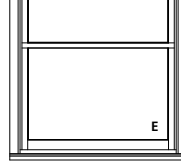

TWD4160

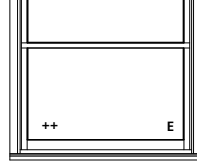

TWD4560

ELEVATION SYMBOL LEGEND

M.O. = MASONRY OPENING
VALUES IN () ARE IN MILLIMETER CONVERSIONS
VALUES IN [] ARE NUMBER OF DAYLIGHT OPENINGS PER UNIT
++ TEMPERED, TINTED AND OBSCURE GLASS OPTIONS ARE NOT AVAILABLE WHEN COMBINED WITH SDL OPTION.
E BASIC UNIT CLEAR OPENING EXCEEDS 20" IN WIDTH, 24" IN HEIGHT & A MINIMUM OF 5.7 SQ. FT.

Note Elevations shown DO NOT have exterior trim. Subtract 3/4" (19) from M.O. (Masonry Opening) for Unit Sizes. Masonry Openings above include Sill Nose, see Trim Options page for Sill Nose specifications. For other Trim Options refer to the Unit Sizing, Rough Opening & Masonry Openings page.

SCALE: 1/4" = 1'

1-WIDE UNITS

M.O. BRICKMOLD 24 3/4" (629)
M.O. ADAMS/FLAT CASING 27 3/4" (705)
ROUGH OPENING 22 1/8" (562)
FRAME SIZE 21 3/8" (543)
DAYLIGHT OPENING 15" (381)

28 3/4" (730)	32 3/4" (832)	36 3/4" (933)	40 3/4" (1035)	44 3/4" (1137)	48 3/4" (1238)
31 3/4" (806)	35 3/4" (908)	39 3/4" (1010)	43 3/4" (1111)	47 3/4" (1213)	51 3/4" (1314)
26 1/8" (664)	30 1/8" (765)	34 1/8" (867)	38 1/8" (968)	42 1/8" (1070)	46 1/8" (1172)
25 3/8" (645)	29 3/8" (746)	33 3/8" (848)	37 3/8" (949)	41 3/8" (1051)	45 3/8" (1153)
19" (483)	23" (584)	27" (686)	31" (787)	35" (889)	39" (991)

67" (1702)
68 1/2" (1740)
65 1/4" (1657)
64 1/2" (1638)
27 9/16" (700)(2)

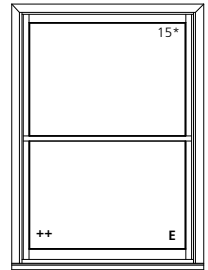
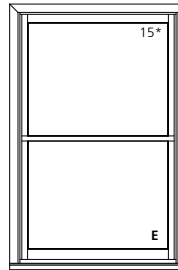
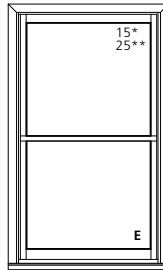
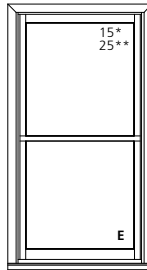
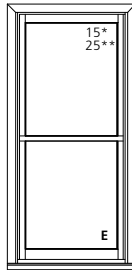
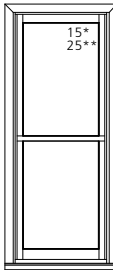
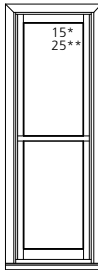

71" (1803)
72 1/2" (1842)
69 1/4" (1759)
68 1/2" (1740)
45 9/16" (1157) 13 9/16" (344)

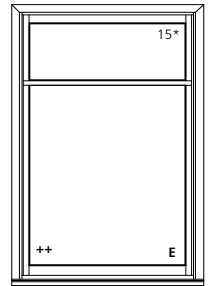
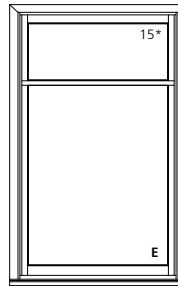
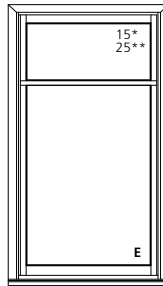
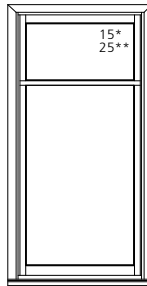
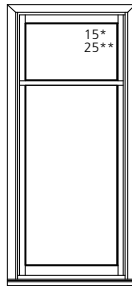
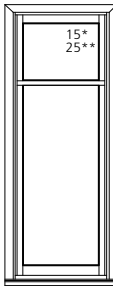
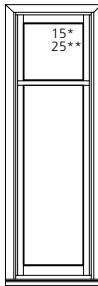

71" (1803)
72 1/2" (1842)
69 1/4" (1759)
68 1/2" (1740)
29 9/16" (75)(2)

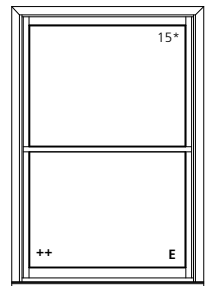
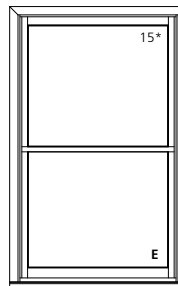
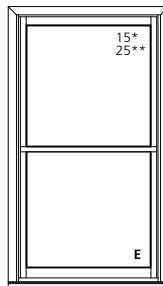
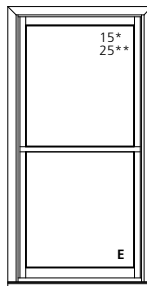
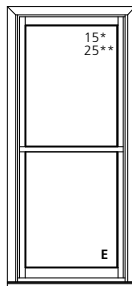
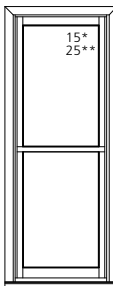
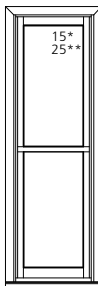

75" (1905)
76 1/2" (1943)
73 1/4" (1861)
72 1/2" (1842)
31 9/16" (802)(2)

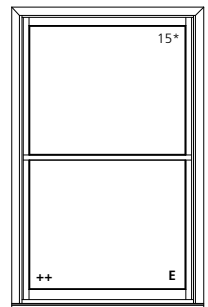
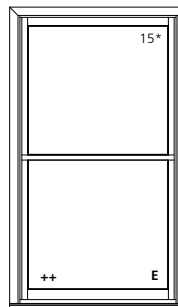
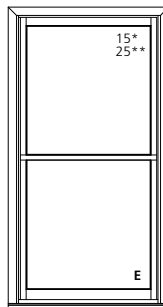
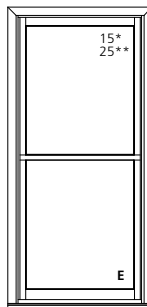
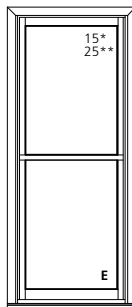
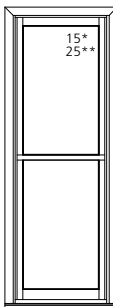
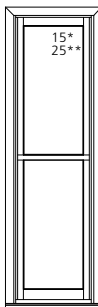

79" (2007)
80 1/2" (2045)
77 1/4" (1962)
76 1/2" (1943)
33 9/16" (852)(2)

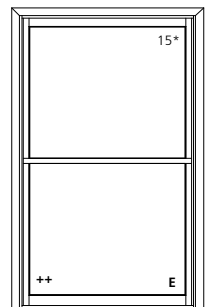
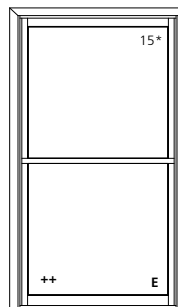
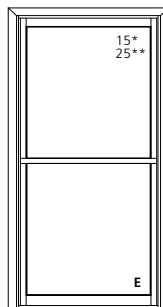
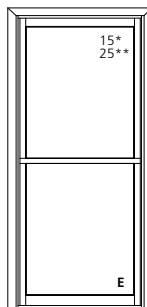
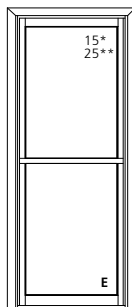
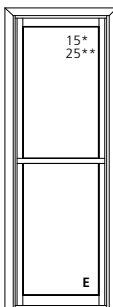
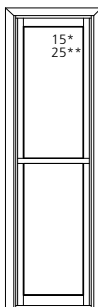

ELEVATION SYMBOL LEGEND

M.O. = MASONRY OPENING
VALUES IN () ARE IN MILLIMETER CONVERSIONS

VALUES IN [] ARE NUMBER OF DAYLIGHT OPENINGS PER UNIT

++ TEMPERED, TINTED AND OBSCURE GLASS OPTIONS ARE NOT AVAILABLE WHEN COMBINED WITH SDL OPTION.

E BASIC UNIT CLEAR OPENING EXCEEDS 20" IN WIDTH, 24" IN HEIGHT & A MINIMUM OF 5.7 SQ. FT.

Note Elevations shown DO NOT have exterior trim. Subtract 3/4" (19) from M.O. (Masonry Opening) for Unit Sizes. Masonry Openings above include Sill Nose, see Trim Options page for Sill Nose specifications. For other Trim Options refer to the Unit Sizing, Rough Opening & Masonry Openings page.

SCALE: 1/4" = 1'

1-WIDE UNITS

M.O. BRICKMOLD
M.O. ADAMS/FLAT CASING
ROUGH OPENING
FRAME SIZE
DAYLIGHT OPENING

24 3/4" (629)
27 3/4" (705)
22 1/8" (562)
21 3/8" (543)
15" (381)

28 3/4" (730)
31 3/4" (806)
26 1/8" (664)
25 3/8" (645)
19" (483)

32 3/4" (832)
35 3/4" (908)
30 1/8" (765)
29 3/8" (746)
23" (584)

36 3/4" (933)
39 3/4" (1010)
34 1/8" (867)
33 3/8" (848)
27" (686)

40 3/4" (1035)
43 3/4" (1111)
38 1/8" (968)
37 3/8" (949)
31" (787)

44 3/4" (1137)
47 3/4" (1213)
42 1/8" (1070)
41 3/8" (1051)
35" (889)

48 3/4" (1238)
51 3/4" (1314)
46 1/8" (1172)
45 3/8" (1153)
39" (991)

83" (2108)
84 1/2" (2146)
81 1/4" (2064)
80 1/2" (2045)
35 9/16" (903) [2]

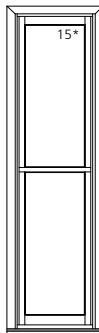

TWD2180

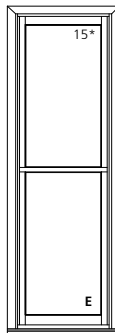

TWD2580

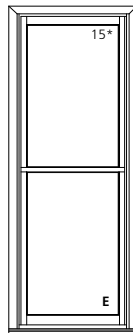

TWD2980

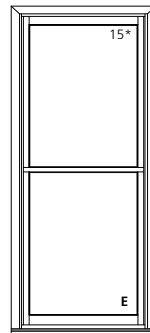

TWD3380

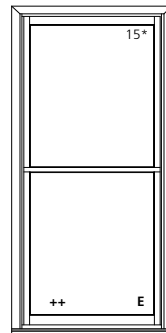

TWD3780

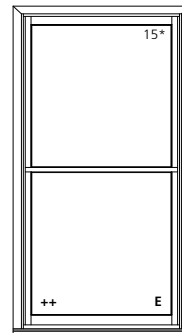

TWD4180

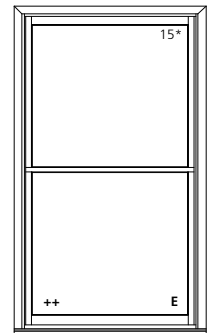

TWD4580

91" (2311)
92 1/2" (2350)
89 1/4" (2267)
88 1/2" (2248)
39 9/16" (1005) [2]

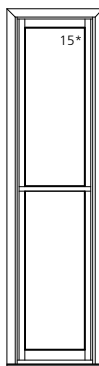

TWD2188

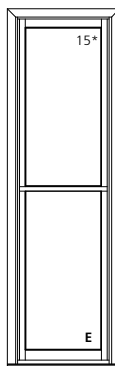

TWD2588

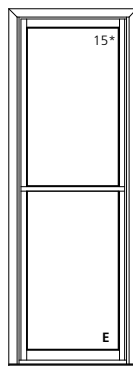

TWD2988

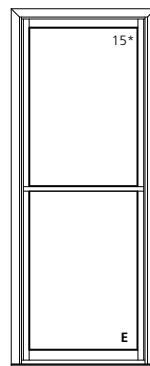

TWD3388

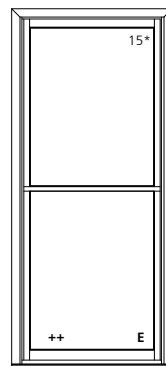

TWD3788

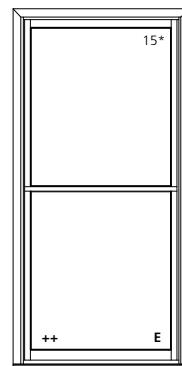

TWD4188

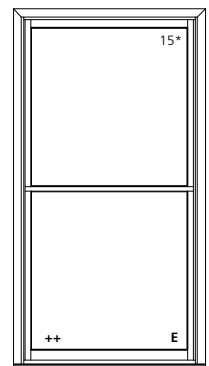

TWD4588

95" (2413)
96 1/2" (2451)
93 1/4" (2369)
92 1/2" (2350)
41 9/16" (1056) [2]

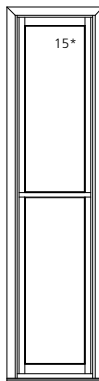

TWD2192

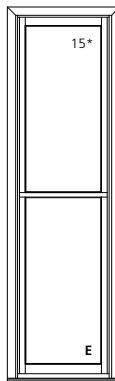

TWD2592

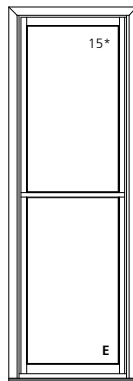

TWD2992

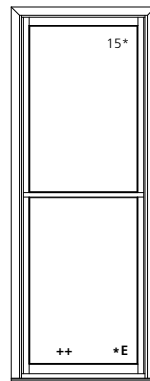

TWD3392

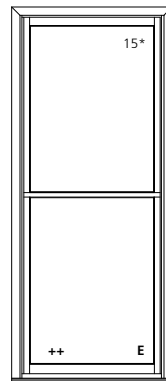

TWD3792

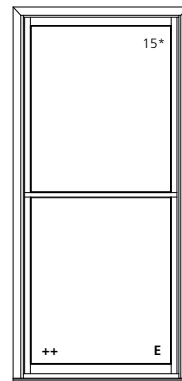

TWD4192

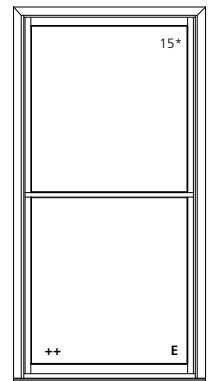

TWD4592

ELEVATION SYMBOL LEGEND

M.O. = MASONRY OPENING
VALUES IN () ARE IN MILLIMETER CONVERSIONS
VALUES IN [] ARE NUMBER OF DAYLIGHT OPENINGS PER UNIT
++ TEMPERED, TINTED AND OBSCURE GLASS OPTIONS ARE NOT AVAILABLE WHEN COMBINED WITH SDL OPTION.
E BASIC UNIT CLEAR OPENING EXCEEDS 20" IN WIDTH, 24" IN HEIGHT & A MINIMUM OF 5.7 SQ. FT.

Note Elevations shown DO NOT have exterior trim. Subtract 3/4" (19) from M.O. (Masonry Opening) for Unit Sizes. Masonry Openings above include Sill Nose, see Trim Options page for Sill Nose specifications. For other Trim Options refer to the Unit Sizing, Rough Opening & Masonry Openings page.

SCALE: 1/4" = 1'

2-WIDE UNITS

M.O. BRICKMOULD
M.O. ADAMS/FLAT CASING
ROUGH OPENING
FRAME SIZE
DAYLIGHT OPENING

46 1/8"(1172)
49 1/8"(1248)
43 1/2"(1105)
42 3/4"(1086)
15"(381)[2]

54 1/8"(1375)
57 1/8"(1451)
51 1/2"(1308)
50 3/4"(1289)
19"(483)[2]

62 1/8"(1578)
65 1/8"(1654)
59 1/2"(1511)
58 3/4"(1492)
23"(584)[2]

70 1/8"(1781)
73 1/8"(1857)
67 1/2"(1715)
66 3/4"(1695)
27"(686)[2]

78 1/8"(1984)
81 1/8"(2061)
75 1/2"(1918)
74 3/4"(1899)
31"(787)[2]

86 1/8"(2188)
89 1/8"(2264)
83 1/2"(2121)
82 3/4"(2102)
35"(889)[2]

94 1/8"(2391)
97 1/8"(2467)
91 1/2"(2324)
90 3/4"(2305)
39"(991)[2]

39"(991)
40 1/2"(1029)
37 1/4"(946)
36 1/2"(927)
13 9/16"(344)[2]



TWD2136-2

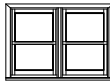

TWD2536-2

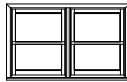

TWD2936-2

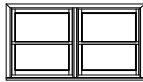

TWD3336-2

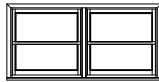

TWD3736-2

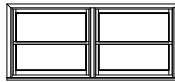

TWD4136-2

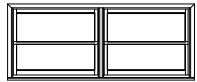

TWD4536-2

43"(1092)
44 1/2"(1130)
41 1/4"(1048)
40 1/2"(1029)
15 9/16"(395)[2]



TWD2140-2

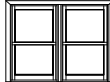

TWD2540-2



TWD2940-2



TWD3340-2

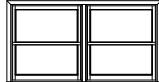

TWD3740-2



TWD4140-2

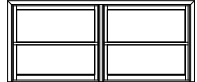

TWD4540-2

51"(1295)
52 1/2"(1334)
49 1/4"(1251)
48 1/2"(1232)
19 9/16"(497)[2]



TWD2148-2

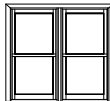

TWD2548-2

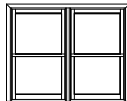

TWD2948-2

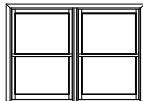

TWD3348-2

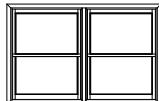

TWD3748-2

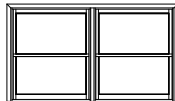

TWD4148-2

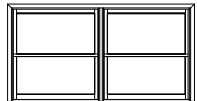

TWD4548-2

55"(1397)
56 1/2"(1435)
53 1/4"(1353)
52 1/2"(1334)
21 9/16"(547)[2]



TWD2152-2

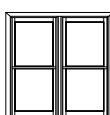

TWD2552-2

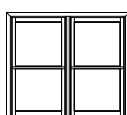

TWD2952-2

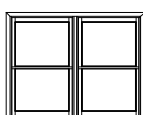

TWD3352-2

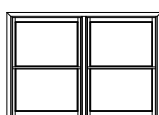

TWD3752-2

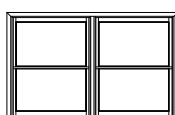

TWD4152-2

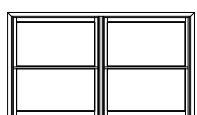

TWD4552-2

59"(1499)
61 1/2"(1537)
57 1/4"(1454)
56 1/2"(1435)
23 9/16"(598)[2]



TWD2156-2

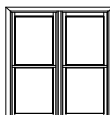

TWD2556-2

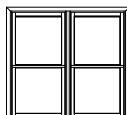

TWD2956-2

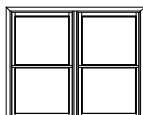

TWD3356-2



TWD3756-2

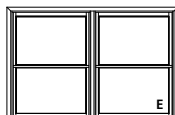

TWD4156-2



TWD4556-2

63"(1600)
64 1/2"(1638)
61 1/4"(1556)
60 1/2"(1537)
25 9/16"(649)[2]



TWD2160-2

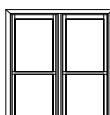

TWD2560-2

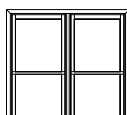

TWD2960-2

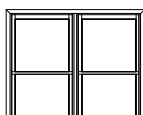

TWD3360-2

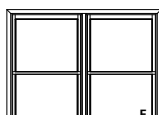

TWD3760-2

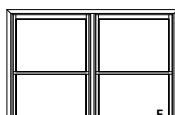

TWD4160-2

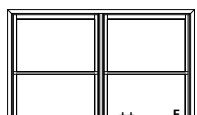

TWD4560-2

67"(1702)
68 1/2"(1740)
65 1/4"(1657)
64 1/2"(1638)
27 9/16"(700)[2]



TWD2164-2



TWD2564-2

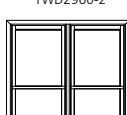

TWD2964-2

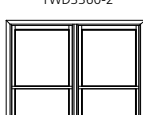

TWD3364-2

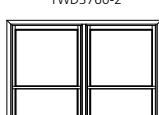

TWD3764-2

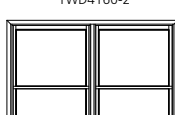

TWD4164-2

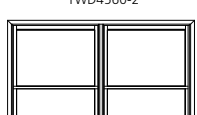

TWD4564-2

71"(1803)
72 1/2"(1842)
69 1/4"(1759)
68 1/2"(1740)
45 9/16"(1157) 13 9/16"(344)



TWD2168C36-2



TWD2568C36-2

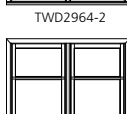

TWD2968C36-2

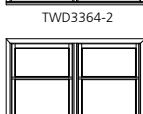

TWD3368C36-2

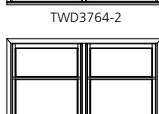

TWD3768C36-2

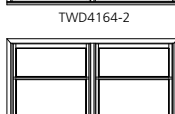

TWD4168C36-2

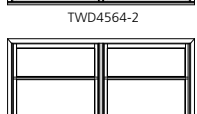

TWD4568C36-2

71"(1803)
72 1/2"(1842)
69 1/4"(1759)
68 1/2"(1740)
29 9/16"(751)[2]



TWD2168-2



TWD2568-2



TWD2968-2



TWD3368-2



TWD3768-2

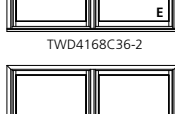

TWD4168-2

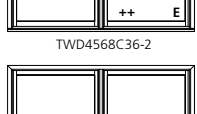

TWD4568-2

ELEVATION SYMBOL LEGEND

M.O. = MASONRY OPENING
VALUES IN () ARE IN MILLIMETER CONVERSIONS
VALUES IN [] ARE NUMBER OF DAYLIGHT OPENINGS PER UNIT
++ TEMPERED, TINTED AND OBSCURE GLASS OPTIONS ARE NOT AVAILABLE WHEN COMBINED WITH SDL OPTION.
E BASIC UNIT CLEAR OPENING EXCEEDS 20" IN WIDTH, 24" IN HEIGHT & A MINIMUM OF 5.7 SQ. FT.

Note Elevations shown DO NOT have exterior trim. Subtract 3/4" (19) from M.O. (Masonry Opening) for Unit Sizes. Masonry Openings above include Sill Nose, see Trim Options page for Sill Nose specifications. For other Trim Options refer to the Unit Sizing, Rough Opening & Masonry Openings page.

SCALE: 1/8" = 1'

2-WIDE UNITS

M.O. BRICKMOULD
M.O. ADAMS/FLAT CASING
ROUGH OPENING
FRAME SIZE
DAYLIGHT OPENING

46 1/8" (1172)
 49 1/8" (1248)
 43 1/2" (1105)
 42 3/4" (1086)
 15" (381)[2]

54 1/8" (1375)
 57 1/8" (1451)
 51 1/2" (1308)
 50 3/4" (1289)
 19" (483)[2]

62 1/8" (1578)
 65 1/8" (1654)
 59 1/2" (1511)
 58 3/4" (1492)
 23" (584)[2]

70 1/8" (1781)
 73 1/8" (1857)
 67 1/2" (1715)
 66 3/4" (1695)
 27" (686)[2]

78 1/8" (1984)
 81 1/8" (2061)
 75 1/2" (1918)
 74 3/4" (1899)
 31" (787)[2]

86 1/8" (2188)
 89 1/8" (2264)
 83 1/2" (2121)
 82 3/4" (2102)
 35" (889)[2]

94 1/8" (2391)
 97 1/8" (2467)
 91 1/2" (2324)
 90 3/4" (2305)
 39" (991)[2]

75" (1905)
 76 1/2" (1943)
 73 1/4" (1861)
 72 1/2" (1842)
 31 9/16" (802)[2]

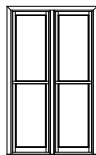

TWD2172-2

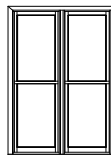

TWD2572-2

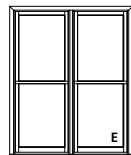

TWD2972-2

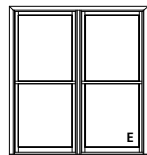

TWD3372-2

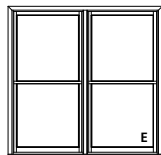

TWD3772-2

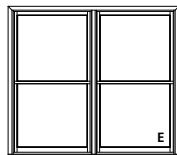

TWD4172-2

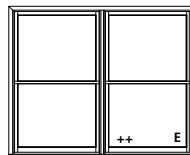

TWD4572-2

79" (2007)
 80 1/2" (2045)
 77 1/4" (1963)
 76 1/2" (1943)
 33 9/16" (852)[2]

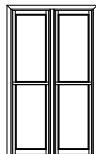

TWD2176-2

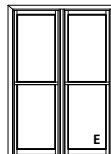

TWD2576-2

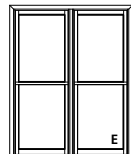

TWD2976-2

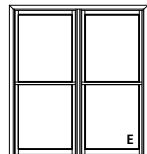

TWD3376-2

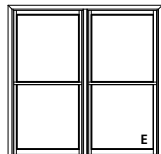

TWD3776-2

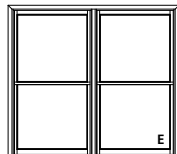

TWD4176-2

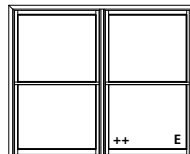

TWD4576-2

82" (2108)
 84 1/2" (2146)
 81 1/4" (2064)
 80 1/2" (2045)
 35 9/16" (903)[2]

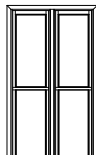

TWD2180-2

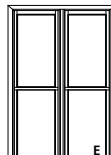

TWD2580-2

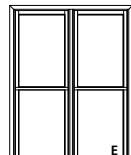

TWD2980-2

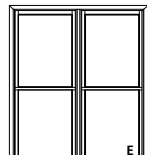

TWD3380-2

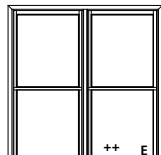

TWD3780-2

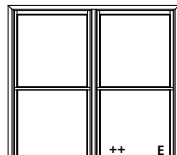

TWD4180-2

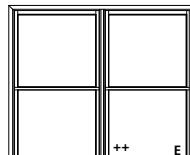

TWD4580-2

91" (2311)
 92 1/2" (2350)
 89 1/4" (2267)
 88 1/2" (2248)
 39 9/16" (1005)[2]

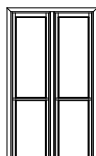

TWD2188-2

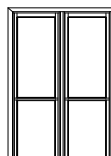

TWD2588-2

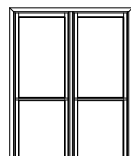

TWD2988-2

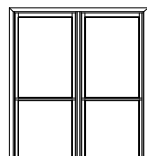

TWD3388-2

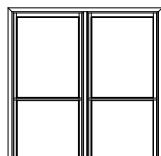

TWD3788-2

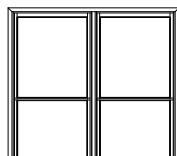

TWD4188-2

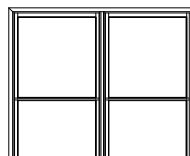

TWD4588-2

95" (2413)
 96 1/2" (2451)
 93 1/4" (2369)
 92 1/2" (2350)
 41 9/16" (1056)[2]

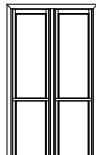

TWD2192-2

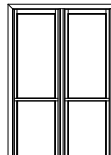

TWD2592-2

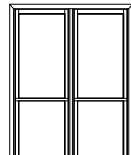

TWD2992-2

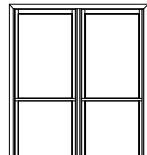

TWD3392-2

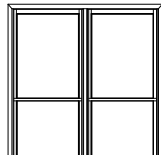

TWD3792-2

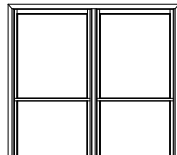

TWD4192-2

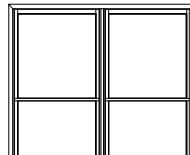

TWD4592-2

ELEVATION SYMBOL LEGEND

M.O. = MASONRY OPENING
 VALUES IN () ARE IN MILLIMETER CONVERSIONS
 VALUES IN [] ARE NUMBER OF DAYLIGHT OPENINGS PER UNIT
 ++ TEMPERED, TINTED AND OBSCURE GLASS OPTIONS ARE NOT AVAILABLE WHEN COMBINED WITH SDL OPTION.
 E BASIC UNIT CLEAR OPENING EXCEEDS 20" IN WIDTH, 24" IN HEIGHT & A MINIMUM OF 5.7 SQ. FT.

Note Elevations shown DO NOT have exterior trim. Subtract 3/4" (19) from M.O. (Masonry Opening) for Unit Sizes. Masonry Openings above include Sill Nose, see Trim Options page for Sill Nose specifications. For other Trim Options refer to the Unit Sizing, Rough Opening & Masonry Openings page.

SCALE: 1/8" = 1'

3-WIDE UNITS

M.O. BRICKMOULD
M.O. ADAMS/FLAT CASING
ROUGH OPENING
FRAME SIZE
DAYLIGHT OPENING

67 1/2" (1715)
70 1/2" (1791)
64 7/8" (1648)
64 1/8" (1629)
15" (381)[3]

79 1/2" (2019)
82 1/2" (2096)
76 7/8" (1953)
76 1/8" (1934)
19" (483)[3]

91 1/2" (2324)
94 1/2" (2400)
88 7/8" (2257)
88 1/8" (2238)
23" (584)[3]

103 1/2" (2629)
106 1/2" (2705)
100 7/8" (2562)
100 1/8" (2543)
27" (686)[3]

115 1/2" (2934)
118 1/2" (3010)
112 7/8" (2867)
112 1/8" (2848)
31" (787)[3]

39" (991)
40 1/2" (1029)
37 1/4" (946)
36 1/2" (927)
13 9/16" (344)[2]

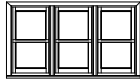

TWD2136-3

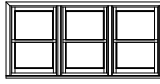

TWD2536-3

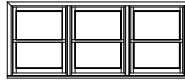

TWD2936-3

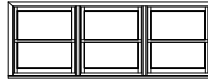

TWD3336-3

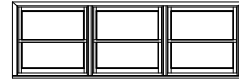

TWD3736-3

43" (1092)
44 1/2" (1130)
41 1/4" (1048)
40 1/2" (1029)
15 9/16" (395)[2]



TWD2140-3



TWD2540-3



TWD2940-3



TWD3340-3



TWD3740-3

51" (1295)
52 1/2" (1334)
49 1/4" (1251)
48 1/2" (1232)
19 9/16" (497)[2]



TWD2148-3



TWD2548-3



TWD2948-3



TWD3348-3



TWD3748-3

55" (1397)
56 1/2" (1435)
53 1/4" (1353)
52 1/2" (1334)
21 9/16" (547)[2]



TWD2152-3



TWD2552-3



TWD2952-3



TWD3352-3



TWD3752-3

59" (1499)
61 1/2" (1537)
57 1/4" (1454)
56 1/2" (1435)
23 9/16" (598)[2]



TWD2156-3



TWD2556-3



TWD2956-3



TWD3356-3



TWD3756-3

63" (1600)
64 1/2" (1638)
61 1/4" (1556)
60 1/2" (1537)
25 9/16" (649)[2]



TWD2160-3



TWD2560-3



TWD2960-3



TWD3360-3



TWD3760-3

67" (1702)
68 1/2" (1740)
65 1/4" (1657)
64 1/2" (1638)
27 9/16" (700)[2]



TWD2164-3



TWD2564-3



TWD2964-3



TWD3364-3



TWD3764-3

71" (1803)
72 1/2" (1842)
69 1/4" (1759)
68 1/2" (1740)
45 9/16" (1157) 13 9/16" (344)



TWD2168C36-3



TWD2568C36-3



TWD2968C36-3

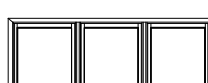

TWD3368C36-3

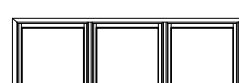

TWD3768C36-3

71" (1803)
72 1/2" (1842)
69 1/4" (1759)
68 1/2" (1740)
29 9/16" (751)[2]



TWD2168-3



TWD2568-3



TWD2968-3

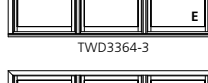

TWD3368-3

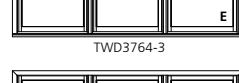

TWD3768-3

ELEVATION SYMBOL LEGEND

M.O. = MASONRY OPENING
VALUES IN () ARE IN MILLIMETER CONVERSIONS
VALUES IN [] ARE NUMBER OF DAYLIGHT OPENINGS PER UNIT
E BASIC UNIT CLEAR OPENING EXCEEDS 20" IN WIDTH, 24" IN HEIGHT & A MINIMUM OF 5.7 SQ. FT.

Note Elevations shown DO NOT have exterior trim. Subtract 3/4" (19) from M.O. (Masonry Opening) for Unit Sizes. Masonry Openings above include Sill Nose, see Trim Options page for Sill Nose specifications. For other Trim Options refer to the Unit Sizing, Rough Opening & Masonry Openings page.

SCALE: 1/8" = 1'

3-WIDE UNITS

M.O. BRICKMOULD
M.O. ADAMS/FLAT CASING
ROUGH OPENING
FRAME SIZE
DAYLIGHT OPENING

67 1/2" (1715)
 70 1/2" (1791)
 64 7/8" (1648)
 64 1/8" (1629)
 15" (381)[3]

79 1/2" (2019)
 82 1/2" (2096)
 76 7/8" (1953)
 76 1/8" (1934)
 19" (483)[3]

91 1/2" (2324)
 94 1/2" (2400)
 88 7/8" (2257)
 88 1/8" (2238)
 23" (584)[3]

103 1/2" (2629)
 106 1/2" (2705)
 100 7/8" (2562)
 100 1/8" (2543)
 27" (686)[3]

115 1/2" (2934)
 118 1/2" (3010)
 112 7/8" (2867)
 112 1/8" (2848)
 31" (787)[3]

75" (1905)
 76 1/2" (1943)
 73 1/4" (1861)
 72 1/2" (1842)
 31 9/16" (802)[2]

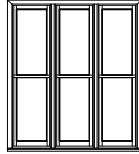

TWD2172-3

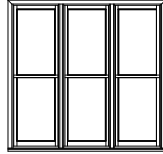

TWD2572-3

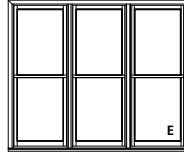

TWD2972-3

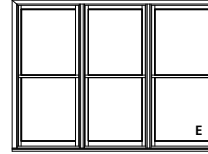

TWD3372-3

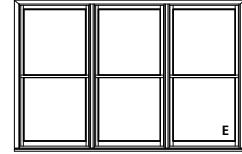

TWD3772-3

79" (2007)
 80 1/2" (2045)
 77 1/4" (1962)
 76 1/2" (1943)
 33 9/16" (852)[2]

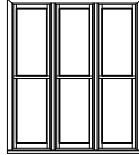

TWD2176-3

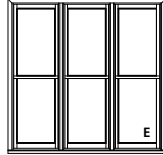

TWD2576-3

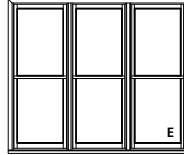

TWD2976-3

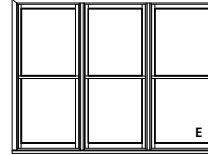

TWD3376-3

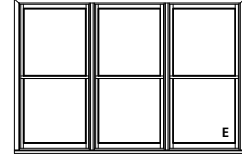

TWD3776-3

83" (2108)
 84 1/2" (2146)
 81 1/4" (2063)
 80 1/2" (2045)
 35 9/16" (903)[2]

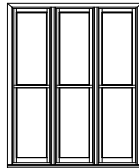

TWD2180-3

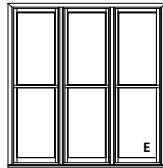

TWD2580-3

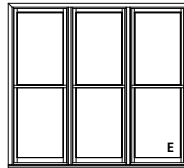

TWD2980-3

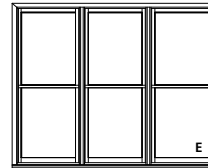

TWD3380-3

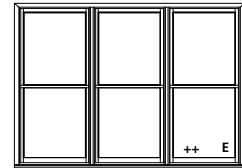

TWD3780-3

91" (2311)
 92 1/2" (2350)
 89 1/4" (2267)
 88 1/2" (2248)
 39 9/16" (1005)[2]

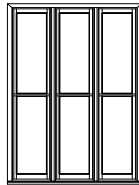

TWD2188-3

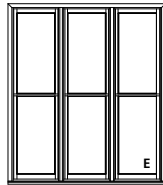

TWD2588-3

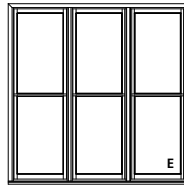

TWD2988-3

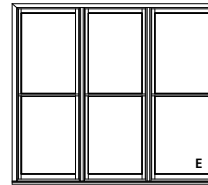

TWD3388-3

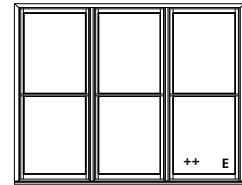

TWD3788-3

95" (2413)
 96 1/2" (2451)
 93 1/4" (2368)
 92 1/2" (2350)
 41 9/16" (1056)[2]

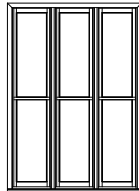

TWD2192-3

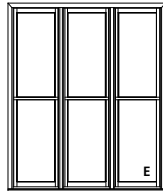

TWD2592-3

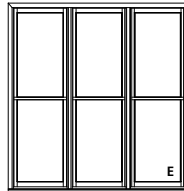

TWD2992-3

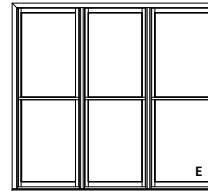

TWD3392-3

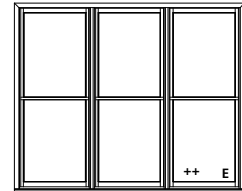

TWD3792-3

ELEVATION SYMBOL LEGEND

M.O. = MASONRY OPENING
 VALUES IN () ARE IN MILLIMETER CONVERSIONS
 VALUES IN [] ARE NUMBER OF DAYLIGHT OPENINGS PER UNIT
 ++ TEMPERED, TINTED AND OBSCURE GLASS OPTIONS ARE NOT AVAILABLE WHEN COMBINED WITH SDL OPTION.
 E BASIC UNIT CLEAR OPENING EXCEEDS 20" IN WIDTH, 24" IN HEIGHT & A MINIMUM OF 5.7 SQ. FT.

Note Elevations shown DO NOT have exterior trim. Subtract 3/4" (19) from M.O. (Masonry Opening) for Unit Sizes. Masonry Openings above include Sill Nose, see Trim Options page for Sill Nose specifications. For other Trim Options refer to the Unit Sizing, Rough Opening & Masonry Openings page.

SCALE: 1/8" = 1'

3-WIDE UNITS

M.O. BRICKMOULD
M.O. ADAMS/FLAT CASING
ROUGH OPENING
FRAME SIZE
DAYLIGHT OPENING

127 1/2"(3239)
130 1/2"(3315)
124 7/8"(3172)
124 1/8"(3153)
35"(889)[3]

139 1/2"(3543)
142 1/2"(3620)
136 7/8"(3475)
136 1/8"(3458)
39"(991)[3]

39"(991)
40 1/2"(1029)
37 1/4"(946)
36 1/2"(927)
13 9/16"(344)[2]

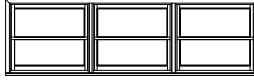

TWD4136-3

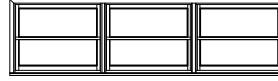

TWD4536-3

43"(1092)
44 1/2"(1130)
41 1/4"(1048)
40 1/2"(1029)
15 9/16"(395)[2]

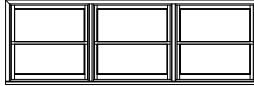

TWD4140-3

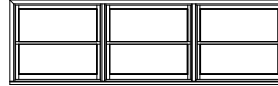

TWD4540-3

51"(1295)
52 1/2"(1334)
49 1/4"(1251)
48 1/2"(1232)
19 9/16"(497)[2]

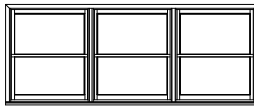

TWD4148-3

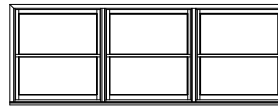

TWD4548-3

55"(1397)
56 1/2"(1435)
53 1/4"(1353)
52 1/2"(1334)
21 9/16"(547)[2]



TWD4152-3



TWD4552-3

59"(1499)
61 1/2"(1537)
57 1/4"(1454)
56 1/2"(1435)
23 9/16"(598)[2]



TWD4156-3

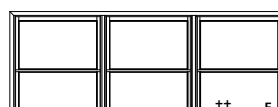

TWD4556-3

63"(1600)
64 1/2"(1638)
61 1/4"(1556)
60 1/2"(1537)
25 9/16"(649)[2]

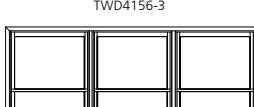

TWD4160-3

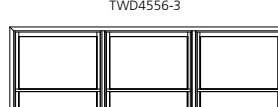

TWD4560-3

67"(1702)
68 1/2"(1740)
65 1/4"(1657)
64 1/2"(1638)
27 9/16"(700)[2]

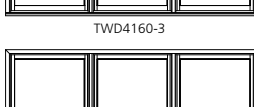

TWD4164-3



TWD4564-3

71"(1803)
72 1/2"(1842)
69 1/4"(1759)
68 1/2"(1740)
45 9/16"(1157) 13 9/16"(344)



TWD4168C36-3



TWD4568C36-3

71"(1803)
72 1/2"(1842)
69 1/4"(1759)
68 1/2"(1740)
29 9/16"(751)[2]



TWD4168-3



TWD4568-3

ELEVATION SYMBOL LEGEND

M.O. = MASONRY OPENING
VALUES IN () ARE IN MILLIMETER CONVERSIONS
VALUES IN [] ARE NUMBER OF DAYLIGHT OPENINGS PER UNIT
++ TEMPERED, TINTED AND OBSCURE GLASS OPTIONS ARE NOT AVAILABLE WHEN COMBINED WITH SDL OPTION.
E BASIC UNIT CLEAR OPENING EXCEEDS 20" IN WIDTH, 24" IN HEIGHT & A MINIMUM OF 5.7 SQ. FT.

Note Elevations shown DO NOT have exterior trim. Subtract 3/4" (19) from M.O. (Masonry Opening) for Unit Sizes. Masonry Openings above include Sill Nose, see Trim Options page for Sill Nose specifications. For other Trim Options refer to the Unit Sizing, Rough Opening & Masonry Openings page.

SCALE: 1/8" = 1'

3-WIDE UNITS

M.O. BRICKMOULD	127 1/2"(3239)	139 1/2"(3543)
M.O. ADAMS/FLAT CASING	130 1/2"(3315)	142 1/2"(3620)
ROUGH OPENING	124 7/8"(3172)	136 7/8"(3475)
FRAME SIZE	124 1/8"(3153)	136 1/8"(3458)
DAYLIGHT OPENING	35"(889)[3]	39"(991)[3]

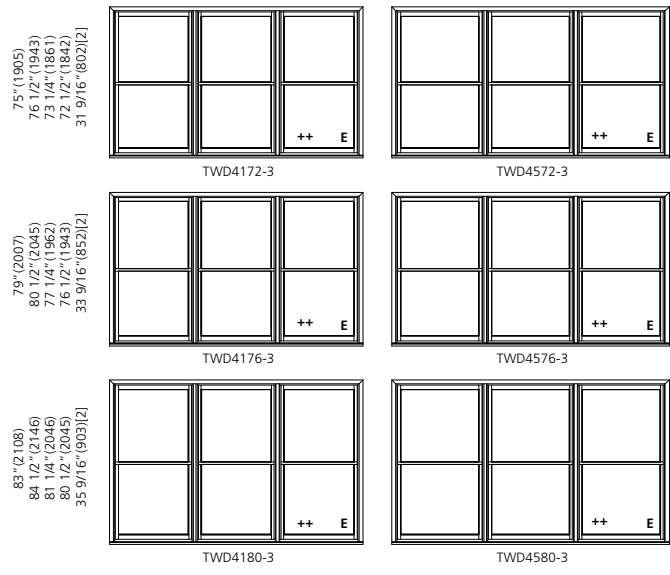

ELEVATION SYMBOL LEGEND

M.O. = MASONRY OPENING
 VALUES IN () ARE IN MILLIMETER CONVERSIONS
 VALUES IN [] ARE NUMBER OF DAYLIGHT OPENINGS PER UNIT
 ++ TEMPERED, TINTED AND OBSCURE GLASS OPTIONS ARE NOT AVAILABLE WHEN COMBINED WITH SDL OPTION.
 E BASIC UNIT CLEAR OPENING EXCEEDS 20" IN WIDTH, 24" IN HEIGHT & A MINIMUM OF 5.7 SQ. FT.

Note Elevations shown DO NOT have exterior trim. Subtract 3/4" (19) from M.O. (Masonry Opening) for Unit Sizes. Masonry Openings above include Sill Nose, see Trim Options page for Sill Nose specifications. For other Trim Options refer to the Unit Sizing, Rough Opening & Masonry Openings page.

SCALE: 1/8" = 1'

ELEVATION NOTES
DOUBLE-HUNG PICTURE

ELEVATION DRAWINGS UTILIZE A LIMITED NUMBER OF PROJECTED LINES TO PRODUCE A RUDIMENTARY DRAWING INTENDED TO BE USED IN A SMALL GRAPHICAL SCALE. ELEVATIONS ARE VIEWED PERPENDICULAR FROM THE EXTERIOR OF THE STRUCTURE. IF MORE DIMENSIONS ARE NEEDED, USE THE SECTION DRAWINGS FOR MORE COMPLETE DEPICTIONS.

M.O. Brickmould
M.O. Adams/Flat Casing
Rough Opening
Frame Size
Daylight Opening

36 3/4"(933)
39 3/4"(1010)
34 1/8"(867)
33 3/8"(848)
28 5/16"(719)

Masonry Openings for Brickmould, Flat & Adams Casing.
Vertical measurements include sillnose.
(Subtract 1/2" from Masonry Opening for Unit Size)

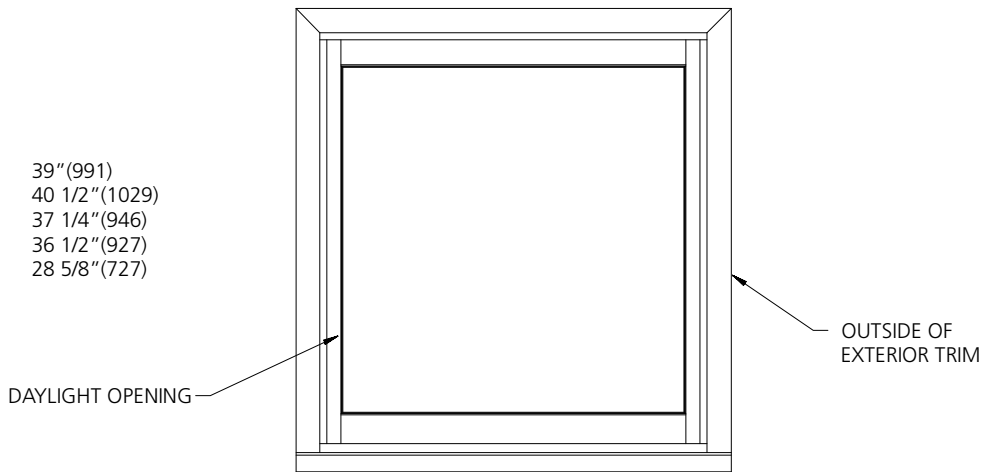

TWDP3336

'TWDP' INDICATES TRADITION PLUS WOOD DH PICTURE

THE FIRST TWO NUMBERS INDICATE THE UNIT WIDTH

BOOK CODE

THE LAST TWO NUMBERS INDICATE THE UNIT HEIGHT

GENERAL DOUBLE-HUNG PICTURE NOTES

1. ALL UNITS SHOWN ARE AVAILABLE AS STATIONARY ONLY.
2. UNIT ELEVATIONS ARE SHOWN WITH BRICKMOULD & SILL NOSE.
3. DIMENSIONAL VALUES IN PARENTHESES ARE MILLIMETER CONVERSIONS.
4. VALUES IN BRACKETS ARE NUMBER OF DAYLIGHT OPENINGS.

ELEVATION SYMBOL LEGEND:

MO MASONRY OPENING

PICTURE UNITS

M.O. BRICKMOLDED
M.O. ADAMS/FLAT CASING
ROUGH OPENING
FRAME SIZE
DAYLIGHT OPENING

20 3/4" (527)	24 3/4" (629)	28 3/4" (730)	32 3/4" (832)	36 3/4" (933)	40 3/4" (1035)	44 3/4" (1137)
23 3/4" (603)	27 3/4" (705)	31 3/4" (806)	35 3/4" (908)	39 3/4" (1010)	43 3/4" (1111)	47 3/4" (1213)
18 1/8" (460)	22 1/8" (562)	25 1/8" (664)	30 1/8" (765)	34 1/8" (867)	38 1/8" (968)	42 1/8" (1070)
17 3/8" (441)	21 3/8" (543)	25 3/8" (645)	29 3/8" (746)	33 3/8" (848)	37 3/8" (949)	41 3/8" (1051)
12 5/16" (313)	16 5/16" (414)	20 5/16" (515)	24 5/16" (618)	28 5/16" (719)	32 5/16" (821)	36 5/16" (922)

39" (991) 40 1/2" (1029) 37 1/4" (946) 36 1/2" (927) 28 5/8" (727)							
43" (1092) 44 1/2" (1130) 41 1/4" (1048) 40 1/2" (1029) 32 5/8" (829)							
51" (1295) 52 1/2" (1334) 49 1/4" (1251) 48 1/2" (1232) 40 5/8" (1032)							
55" (1397) 56 1/2" (1435) 53 1/4" (1353) 52 1/2" (1334) 44 5/8" (1133)							
59" (1499) 60 1/2" (1537) 57 1/4" (1454) 56 1/2" (1435) 48 5/8" (1235)							
63" (1600) 64 1/2" (1638) 61 1/4" (1556) 60 1/2" (1537) 52 5/8" (1337)							

ELEVATION SYMBOL LEGEND
M.O. = MASONRY OPENING
VALUES IN () ARE IN MILLIMETER CONVERSIONS

Note Elevations shown DO NOT have exterior trim. Subtract 3/4" (19) from M.O. (Masonry Opening) for Unit Sizes. Masonry Openings above include Sill Nose, see Trim Options page for Sill Nose specifications. For other Trim Options refer to the Unit Sizing, Rough Opening & Masonry Openings page.

SCALE: 1/4" = 1'

PICTURE UNITS

M.O. BRICKMOULD
M.O. ADAMS/FLAT CASING
ROUGH OPENING
FRAME SIZE
DAYLIGHT OPENING

20 3/4" (527)	24 3/4" (629)	28 3/4" (730)	32 3/4" (832)	36 3/4" (933)	40 3/4" (1035)	44 3/4" (1137)
23 3/4" (603)	27 3/4" (705)	31 3/4" (806)	35 3/4" (908)	39 3/4" (1010)	43 3/4" (1111)	47 3/4" (1213)
18 1/8" (460)	22 1/8" (562)	26 1/8" (664)	30 1/8" (765)	34 1/8" (867)	38 1/8" (968)	42 1/8" (1070)
17 3/8" (441)	21 3/8" (543)	25 3/8" (645)	29 3/8" (746)	33 3/8" (848)	37 3/8" (949)	41 3/8" (1051)
12 5/16" (313)	16 5/16" (414)	20 5/16" (515)	24 5/16" (618)	28 5/16" (719)	32 5/16" (821)	36 5/16" (922)

67" (1702)
68 1/2" (1740)
65 1/4" (1657)
64 1/2" (1638)
56 5/8" (1438)

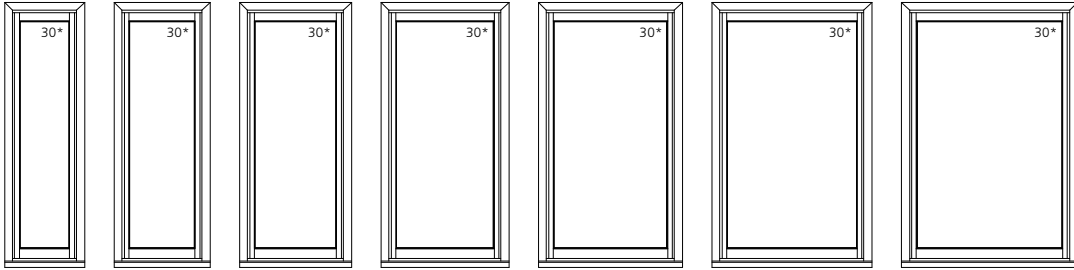

71" (1803)
72 1/2" (1842)
69 1/4" (1759)
68 1/2" (1740)
60 5/8" (1540)

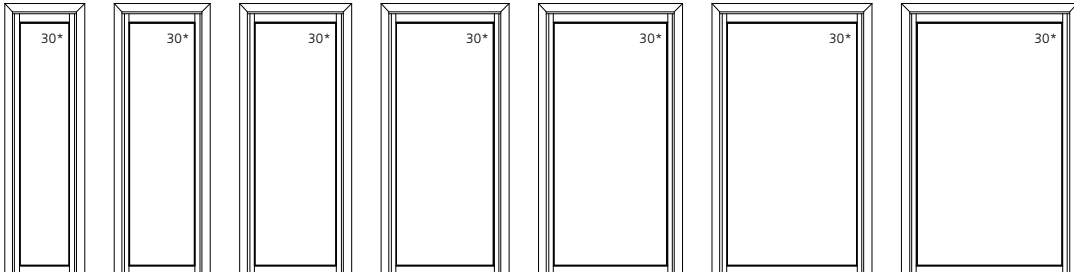

75" (1905)
76 1/2" (1943)
73 1/4" (1861)
72 1/2" (1842)
64 5/8" (1641)

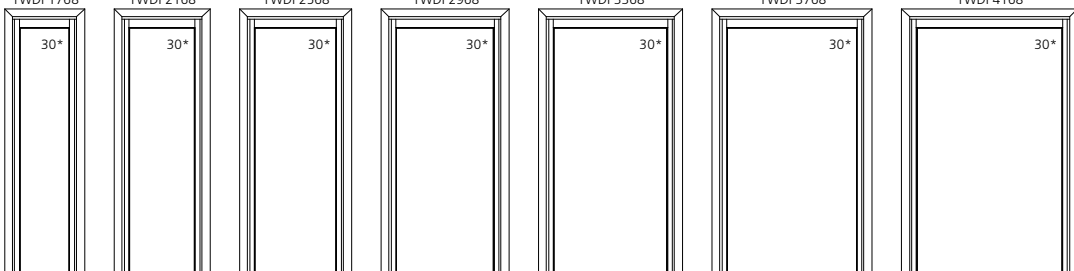

79" (2007)
80 1/2" (2045)
77 1/4" (1962)
76 1/2" (1943)
68 5/8" (1743)

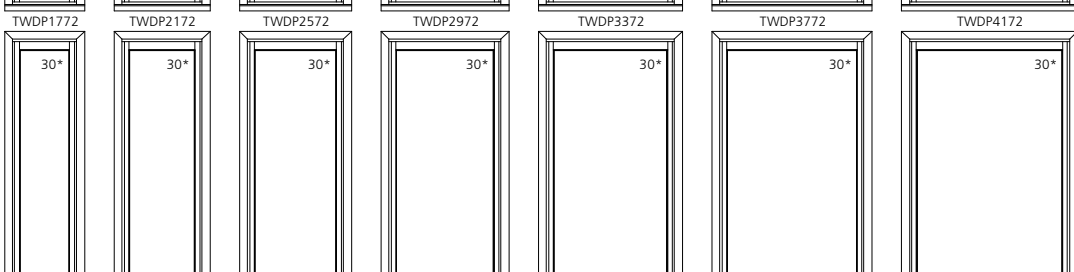

83" (2108)
84 1/2" (2146)
81 1/4" (2064)
80 1/2" (2045)
72 5/8" (1845)



ELEVATION SYMBOL LEGEND
M.O. = MASONRY OPENING
VALUES IN () ARE IN MILLIMETER CONVERSIONS

Note Elevations shown DO NOT have exterior trim. Subtract 3/4" (19) from M.O. (Masonry Opening) for Unit Sizes. Masonry Openings above include Sill Nose, see Trim Options page for Sill Nose specifications. For other Trim Options refer to the Unit Sizing, Rough Opening & Masonry Openings page.

SCALE: 1/4" = 1'

PICTURE UNITS

M.O. BRICKMOULD	20 3/4" (527)	24 3/4" (629)	28 3/4" (730)	32 3/4" (832)	36 3/4" (933)	40 3/4" (1035)	44 3/4" (1137)
M.O. ADAMS/FLAT CASING	23 3/4" (603)	27 3/4" (705)	31 3/4" (806)	35 3/4" (908)	39 3/4" (1010)	43 3/4" (1111)	47 3/4" (1213)
ROUGH OPENING	18 1/8" (460)	22 1/8" (562)	26 1/8" (664)	30 1/8" (765)	34 1/8" (867)	38 1/8" (968)	42 1/8" (1070)
FRAME SIZE	17 3/8" (441)	21 3/8" (543)	25 3/8" (645)	29 3/8" (746)	33 3/8" (848)	37 3/8" (949)	41 3/8" (1051)
DAYLIGHT OPENING	12 5/16" (313)	16 5/16" (414)	20 5/16" (515)	24 5/16" (618)	28 5/16" (719)	32 5/16" (821)	36 5/16" (922)

91" (2311)
92 1/2" (2350)
88 1/4" (2267)
88 1/2" (2248)
80 5/8" (2048)

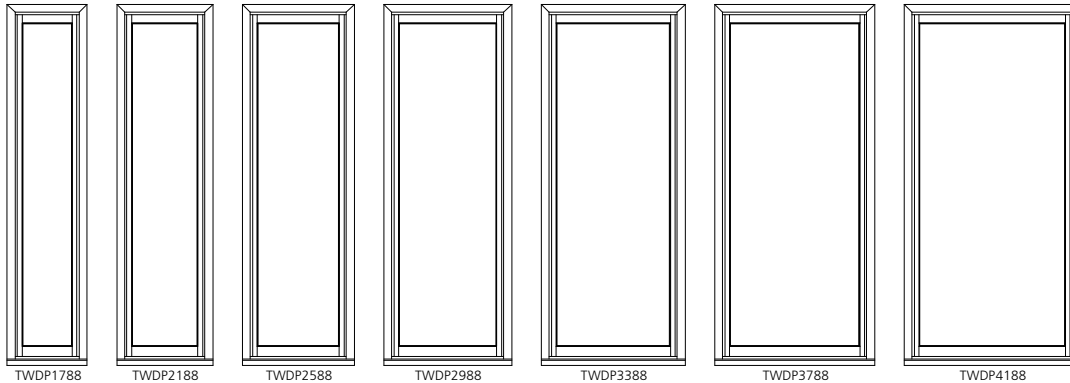

ELEVATION SYMBOL LEGEND
M.O. = MASONRY OPENING
VALUES IN () ARE IN MILLIMETER CONVERSIONS

Note Elevations shown DO NOT have exterior trim. Subtract 3/4" (19) from M.O. (Masonry Opening) for Unit Sizes. Masonry Openings above include Sill Nose, see Trim Options page for Sill Nose specifications. For other Trim Options refer to the Unit Sizing, Rough Opening & Masonry Openings page.

SCALE: 1/4" = 1'

PICTURE UNITS

M.O. BRICKMOULD
M.O. ADAMS/FLAT CASING
ROUGH OPENING
FRAME SIZE
DAYLIGHT OPENING

48 3/4" (1238)
51 3/4" (1314)
46 1/8" (1172)
45 3/8" (1153)
40 5/16" (1024)

52 3/4" (1340)
55 3/4" (1416)
50 1/8" (1273)
49 3/8" (1254)
44 5/16" (1126)

56 3/4" (1441)
59 3/4" (1518)
54 1/8" (1375)
53 3/8" (1356)
48 5/16" (1227)

64 3/4" (1645)
67 3/4" (1721)
62 1/8" (1578)
61 3/8" (1559)
56 5/16" (1430)

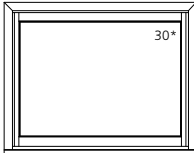
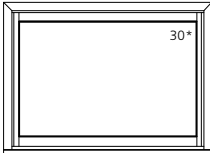
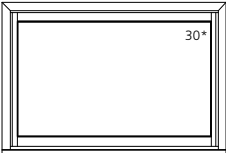
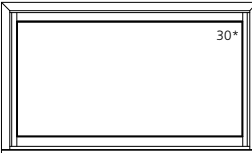
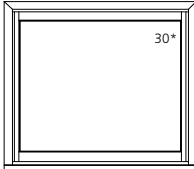
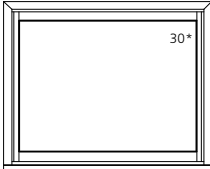
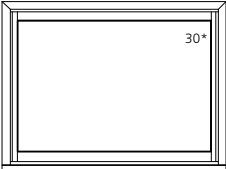
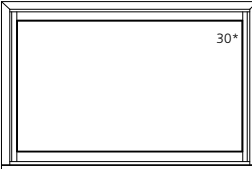
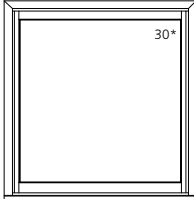
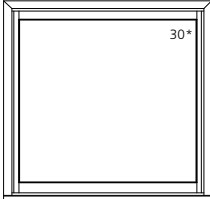
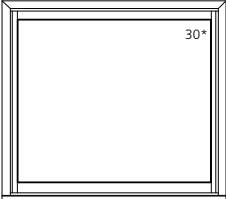
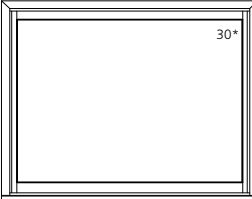
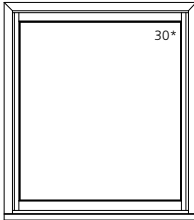
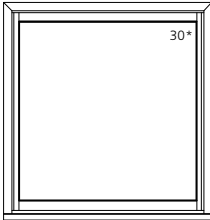
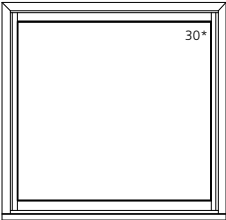
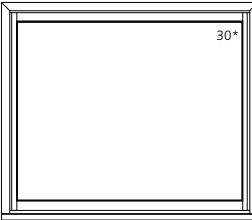
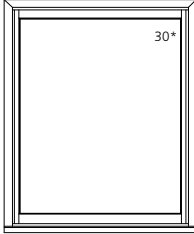
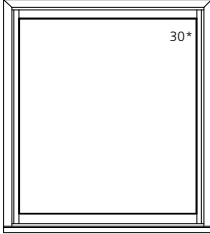
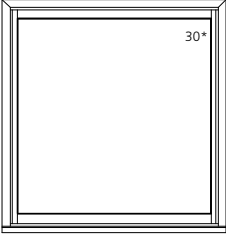
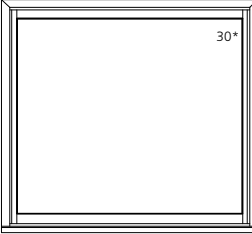
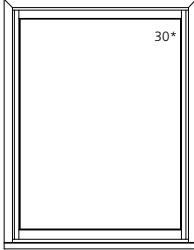
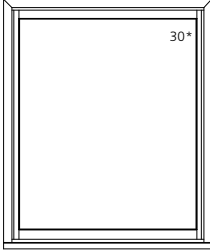
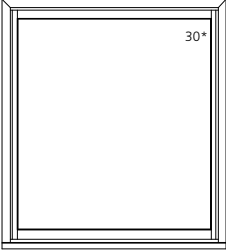
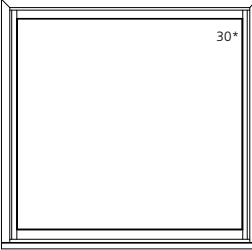
39" (991) 40 1/2" (1029) 37 1/4" (946) 36 1/2" (927) 28 5/8" (727)				
43" (1092) 44 1/2" (1130) 41 1/4" (1048) 40 1/2" (1029) 32 5/8" (829)				
51" (1295) 52 1/2" (1334) 49 1/4" (1251) 48 1/2" (1232) 40 5/8" (1032)				
55" (1397) 56 1/2" (1435) 53 1/4" (1353) 52 1/2" (1334) 44 5/8" (1133)				
59" (1499) 60 1/2" (1537) 57 1/4" (1454) 56 1/2" (1435) 48 5/8" (1235)				
63" (1600) 64 1/2" (1638) 61 1/4" (1556) 60 1/2" (1537) 52 5/8" (1337)				

ELEVATION SYMBOL LEGEND
M.O. = MASONRY OPENING
VALUES IN () ARE IN MILLIMETER CONVERSIONS

Note Elevations shown DO NOT have exterior trim. Subtract 3/4" (19) from M.O. (Masonry Opening) for Unit Sizes. Masonry Openings above include Sill Nose, see Trim Options page for Sill Nose specifications. For other Trim Options refer to the Unit Sizing, Rough Opening & Masonry Openings page.

SCALE: 1/4" = 1'

PICTURE UNITS

M.O. BRICKMOULD
M.O. ADAMS/FLAT CASING
ROUGH OPENING
FRAME SIZE
DAYLIGHT OPENING

48 3/4"(1238)
51 3/4"(1314)
46 1/8"(1172)
45 3/8"(1153)
40 5/16"(1024)

52 3/4"(1340)
55 3/4"(1416)
50 1/8"(1273)
49 3/8"(1254)
44 5/16"(1126)

56 3/4"(1441)
59 3/4"(1518)
54 1/8"(1375)
53 3/8"(1356)
48 5/16"(1227)

64 3/4"(1645)
67 3/4"(1721)
62 1/8"(1578)
61 3/8"(1559)
56 5/16"(1430)

67"(1702)
68 1/2"(1740)
65 1/4"(1657)
64 1/2"(1638)
56 5/8"(1438)

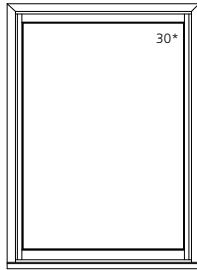

TWDP4564

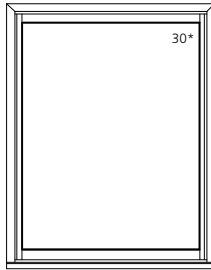

TWDP4964

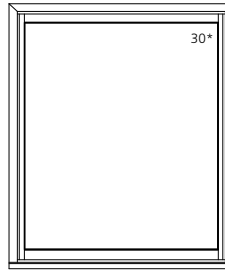

TWDP5364

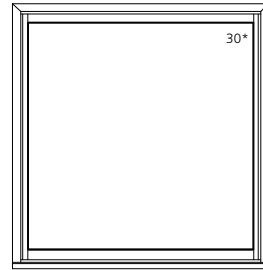

TWDP6164

71"(1803)
72 1/2"(1842)
69 1/4"(1759)
68 1/2"(1740)
60 5/8"(1540)

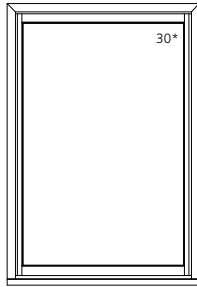

TWDP4568

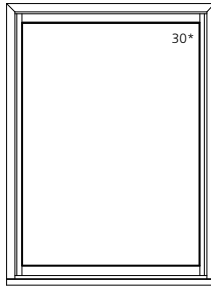

TWDP4968

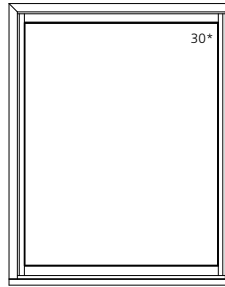

TWDP5368

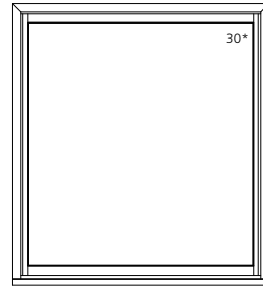

TWDP6168

75"(1905)
76 1/2"(1943)
73 1/4"(1861)
72 1/2"(1842)
64 5/8"(1641)

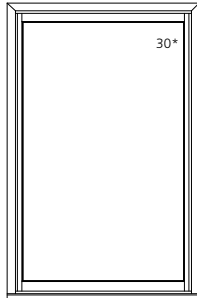

TWDP4572

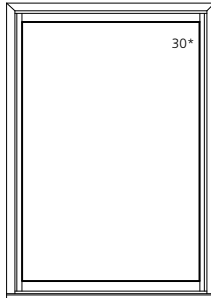

TWDP4972

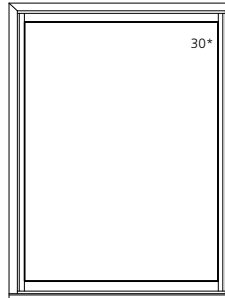

TWDP5372

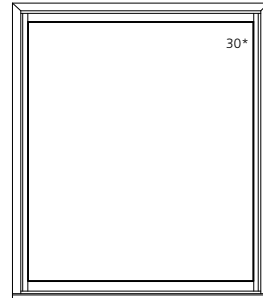

TWDP6172

79"(2007)
80 1/2"(2045)
77 1/4"(1962)
76 1/2"(1943)
68 5/8"(1743)

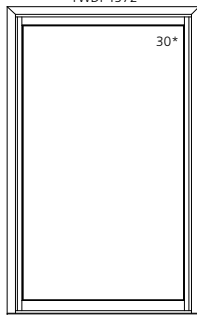

TWDP4576

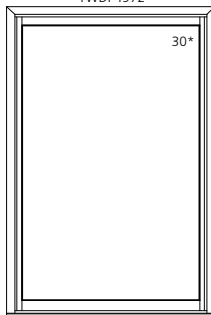

TWDP4976

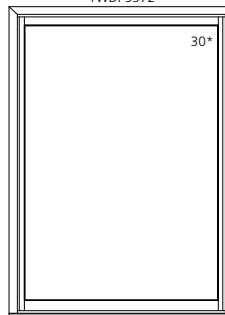

TWDP5376

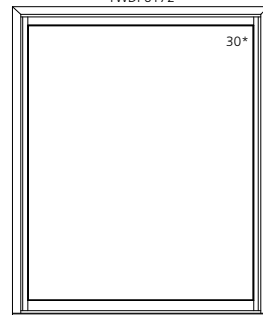

TWDP6176

83"(2108)
84 1/2"(2146)
81 1/4"(2064)
80 1/2"(2045)
72 5/8"(1845)

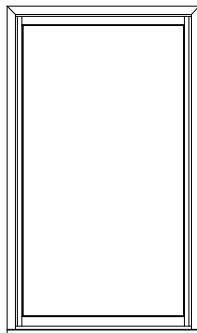

TWDP4580

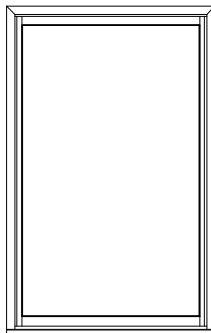

TWDP4980

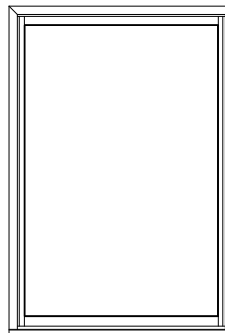

TWDP5380

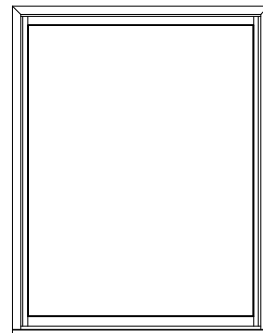

TWDP6180

ELEVATION SYMBOL LEGEND
M.O. = MASONRY OPENING
VALUES IN () ARE IN MILLIMETER CONVERSIONS

Note Elevations shown DO NOT have exterior trim. Subtract 3/4" (19) from M.O. (Masonry Opening) for Unit Sizes. Masonry Openings above include Sill Nose, see Trim Options page for Sill Nose specifications. For other Trim Options refer to the Unit Sizing, Rough Opening & Masonry Openings page.

SCALE: 1/4" = 1'

PICTURE UNITS

M.O. BRICKMOULD
M.O. ADAMS/FLAT CASING
ROUGH OPENING
FRAME SIZE
DAYLIGHT OPENING

48 3/4"(1238)
51 3/4"(1314)
46 1/8"(1172)
45 3/8"(1153)
40 5/16"(1024)

52 3/4"(1340)
55 3/4"(1416)
50 1/8"(1273)
49 3/8"(1254)
44 5/16"(1126)

56 3/4"(1441)
59 3/4"(1518)
54 1/8"(1375)
53 3/8"(1356)
48 5/16"(1227)

64 3/4"(1645)
67 3/4"(1721)
62 1/8"(1578)
61 3/8"(1559)
56 5/16"(1430)

91"(2311)
92 1/2"(2350)
89 1/4"(2267)
88 1/2"(2248)
80 5/8"(2048)

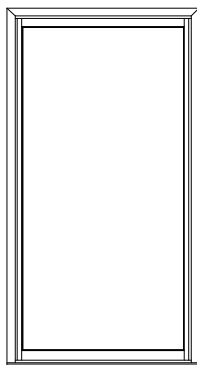

TWDP4588

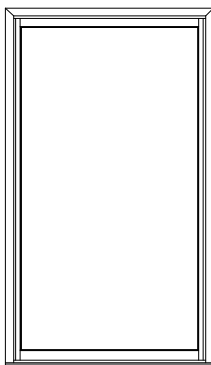

TWDP4988

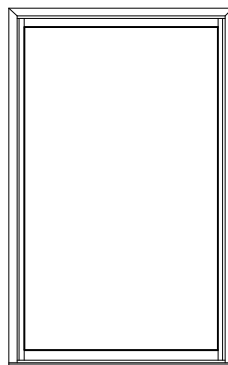

TWDP5388

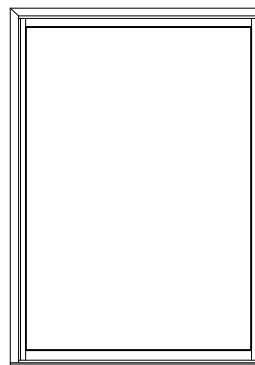

TWDP6188

ELEVATION SYMBOL LEGEND
M.O. = MASONRY OPENING
VALUES IN () ARE IN MILLIMETER CONVERSIONS

Note Elevations shown DO NOT have exterior trim. Subtract 3/4" (19) from M.O. (Masonry Opening) for Unit Sizes. Masonry Openings above include Sill Nose, see Trim Options page for Sill Nose specifications. For other Trim Options refer to the Unit Sizing, Rough Opening & Masonry Openings page.

SCALE: 1/4" = 1'

PICTURE UNITS

M.O. BRICKMOULD 76 3/4" (1949)
M.O. ADAMS/FLAT CASING 79 3/4" (2026)
ROUGH OPENING 74 1/8" (1883)
FRAME SIZE 73 3/8" (1864)
DAYLIGHT OPENING 68 5/16" (1735)

M.O. BRICKMOULD 76 3/4" (1949)
M.O. ADAMS/FLAT CASING 79 3/4" (2026)
ROUGH OPENING 74 1/8" (1883)
FRAME SIZE 73 3/8" (1864)
DAYLIGHT OPENING 68 5/16" (1735)

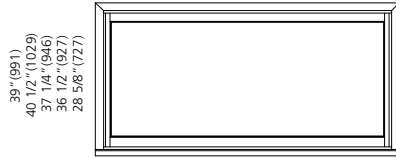

TWDP7336

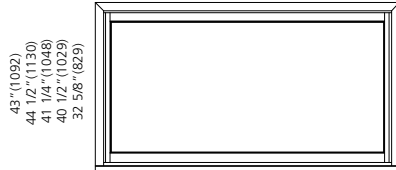

TWDP7340

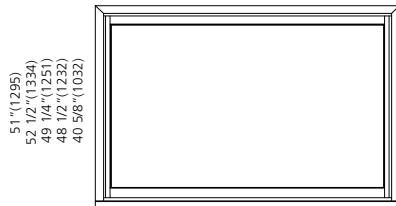

TWDP7348

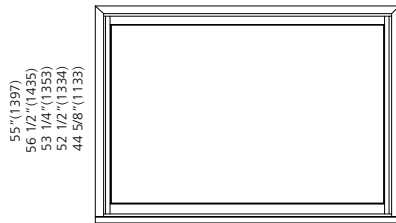

TWDP7352

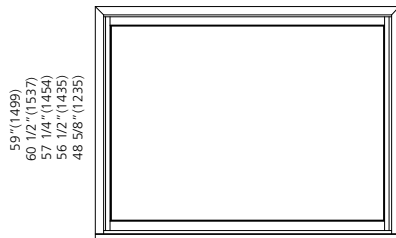

TWDP7356

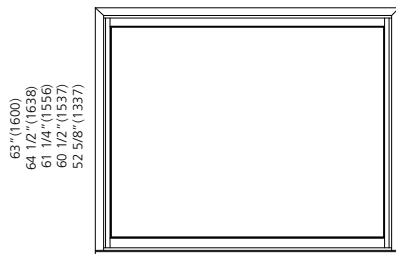

TWDP7360

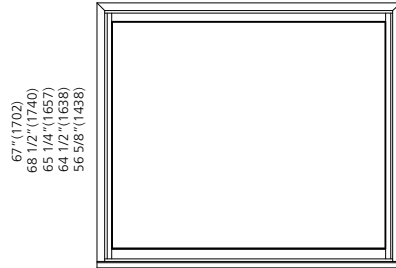

TWDP7364

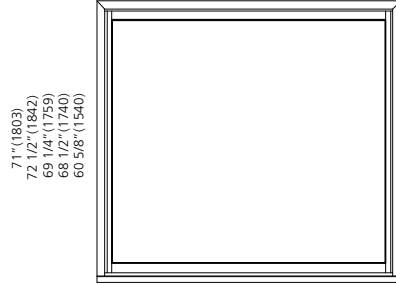

TWDP7368

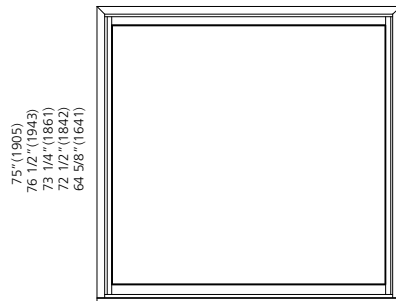

TWDP7372

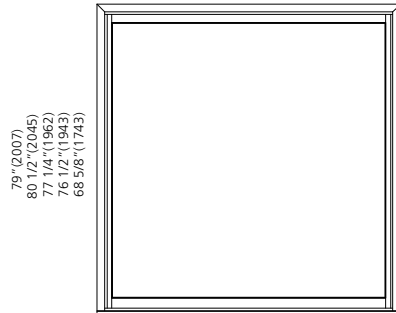

TWDP7376

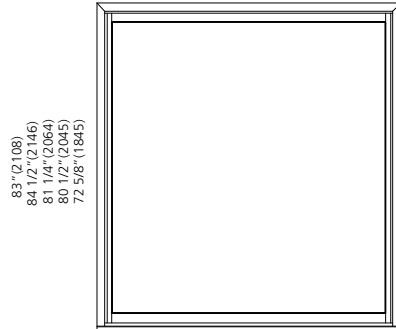

TWDP7380

ELEVATION SYMBOL LEGEND
M.O. = MASONRY OPENING
VALUES IN () ARE IN MILLIMETER CONVERSIONS

Note Elevations shown DO NOT have exterior trim. Subtract 3/4" (19) from M.O. (Masonry Opening) for Unit Sizes. Masonry Openings above include Sill Nose, see Trim Options page for Sill Nose specifications. For other Trim Options refer to the Unit Sizing, Rough Opening & Masonry Openings page.

SCALE: 1/4" = 1'

PICTURE UNITS

M.O. BRICKMOULD
M.O. ADAMS/FLAT CASING
ROUGH OPENING
FRAME SIZE
DAYLIGHT OPENING

76 3/4" (1949)
79 3/4" (2026)
74 1/8" (1883)
73 3/8" (1864)
68 5/16" (1735)

91" (2311)
92 1/2" (2350)
89 1/4" (2267)
88 1/2" (2248)
80 5/8" (2048)

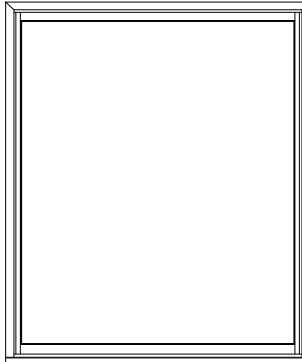

TWDP7388

ELEVATION SYMBOL LEGEND
M.O. = MASONRY OPENING
VALUES IN () ARE IN MILLIMETER CONVERSIONS

Note Elevations shown DO NOT have exterior trim. Subtract 3/4" (19) from M.O. (Masonry Opening) for Unit Sizes. Masonry Openings above include Sill Nose, see Trim Options page for Sill Nose specifications. For other Trim Options refer to the Unit Sizing, Rough Opening & Masonry Openings page.

SCALE: 1/4" = 1'

PICTURE UNITS WITH 21" FLANKERS

M.O. BRICKMOULD
M.O. ADAMS/FLAT CASING
ROUGH OPENING
FRAME SIZE
DAYLIGHT OPENING

	95 1/2" (2426) 98 1/2" (2502) 92 7/8" (2359) 92 1/8" (2340)	99 1/2" (2527) 102 1/2" (2604) 96 7/8" (2461) 96 1/8" (2442)	107 1/2" (2731) 110 1/2" (2807) 104 7/8" (2664) 104 1/8" (2645)	119 1/2" (3035) 122 1/2" (3112) 116 7/8" (2968) 116 1/8" (2950)
	15" (381) [2] 44 5/16" (1126)	15" (381) [2] 44 5/16" (1227)	15" (381) [2] 44 5/16" (1430)	15" (381) [2] 44 5/16" (1735)
51" (1295) 52 1/2" (1334) 49 1/4" (1251) 48 1/2" (1232) 19 9/16" (497) [2] 40 5/8" (1032)				
	TWD4948-21	TWD5348-21	TWD6148-21	TWD7348-21
55" (1397) 56 1/2" (1435) 53 1/4" (1353) 52 1/2" (1334) 21 9/16" (547) [2] 44 5/8" (1133)				
	TWD4952-21	TWD5352-21	TWD6152-21	TWD7352-21
59" (1499) 60 1/2" (1537) 57 1/4" (1454) 56 1/2" (1435) 23 9/16" (598) [2] 48 5/8" (1235)				
	TWD4956-21	TWD5356-21	TWD6156-21	TWD7356-21
67" (1702) 68 1/2" (1740) 65 1/4" (1657) 64 1/2" (1638) 27 9/16" (700) [2] 46 5/8" (1188)				
	TWD4964-21	TWD5364-21	TWD6164-21	TWD7364-21
71" (1803) 72 1/2" (1842) 69 1/4" (1759) 68 1/2" (1740) 29 9/16" (751) [2] 60 5/8" (1540)				
	TWD4968-21	TWD5368-21	TWD6168-21	TWD7368-21
79" (2007) 80 1/2" (2045) 77 1/4" (1962) 76 1/2" (1943) 33 9/16" (852) [2] 68 5/8" (1743)				
	TWD4976-21	TWD5376-21	TWD6176-21	TWD7376-21











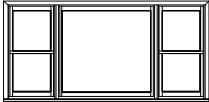

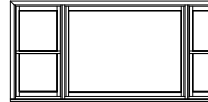
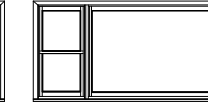
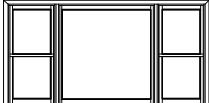

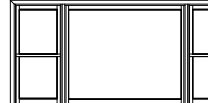

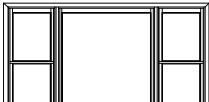

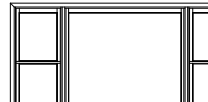
ELEVATION SYMBOL LEGEND

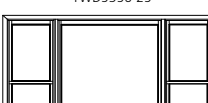
M.O. = MASONRY OPENING
VALUES IN () ARE IN MILLIMETER CONVERSIONS
VALUES IN [] ARE NUMBER OF DAYLIGHT OPENINGS PER UNIT

Note Elevations shown DO NOT have exterior trim. Subtract 3/4" (19) from M.O. (Masonry Opening) for Unit Sizes. Masonry Openings above include Sill Nose, see Trim Options page for Sill Nose specifications. For other Trim Options refer to the Unit Sizing, Rough Opening & Masonry Openings page.

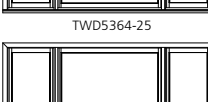
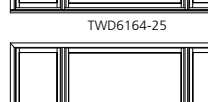
SCALE: 1/8" = 1'

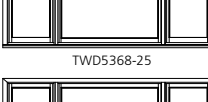
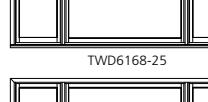
PICTURE UNITS WITH 25" FLANKERS

M.O. BRICKMOULD M.O. ADAMS/FLAT CASING ROUGH OPENING FRAME SIZE DAYLIGHT OPENING	103 1/2"(2629) 106 1/2"(2705) 100 7/8"(2562) 100 1/8"(2543)	107 1/2"(2731) 110 1/2"(2807) 104 7/8"(2664) 104 1/8"(2645)	115 1/2"(2934) 118 1/2"(3010) 112 7/8"(2867) 112 1/8"(2848)	127 1/2"(3239) 130 1/2"(3315) 124 7/8"(3172) 124 1/8"(3153)
	19"(483)[2] 44 5/16"(1126)	19"(483)[2] 48 5/16"(1227)	19"(483)[2] 56 5/16"(1430)	19"(483)[2] 68 5/16"(1735)
51"(1295) 52 1/2"(1334) 49 1/4"(1251) 48 1/2"(1232) 19 9/16"(497)[2] 40 5/8"(1032)	 TWD4948-25	 TWD5348-25	 TWD6148-25	 TWD7348-25
55"(1397) 56 1/2"(1435) 53 1/4"(1353) 52 1/2"(1334) 21 9/16"(547)[2] 44 5/8"(1133)	 TWD4952-25	 TWD5352-25	 TWD6152-25	 TWD7352-25
59"(1499) 60 1/2"(1537) 57 1/4"(1454) 56 1/2"(1435) 23 9/16"(598)[2] 46 5/8"(1235)	 TWD4956-25	 TWD5356-25	 TWD6156-25	 TWD7356-25
67"(1702) 68 1/2"(1740) 65 1/4"(1657) 64 1/2"(1638) 27 9/16"(700)[2] 46 5/8"(1438)	 TWD4964-25	 TWD5364-25	 TWD6164-25	 TWD7364-25
71"(1803) 72 1/2"(1842) 69 1/4"(1759) 68 1/2"(1740) 29 9/16"(751)[2] 60 5/8"(1540)	 TWD4968-25	 TWD5368-25	 TWD6168-25	 TWD7368-25
79"(2007) 80 1/2"(2045) 77 1/4"(1962) 76 1/2"(1943) 33 9/16"(852)[2] 66 5/8"(1745)	 TWD4976-25	 TWD5376-25	 TWD6176-25	 TWD7376-25

ELEVATION SYMBOL LEGEND

M.O. = MASONRY OPENING
VALUES IN () ARE IN MILLIMETER CONVERSIONS
VALUES IN [] ARE NUMBER OF DAYLIGHT OPENINGS PER UNIT
E BASIC UNIT CLEAR OPENING EXCEEDS 20" IN WIDTH, 24" IN HEIGHT & A MINIMUM OF 5.7 SQ. FT.

Note Elevations shown DO NOT have exterior trim. Subtract 3/4" (19) from M.O. (Masonry Opening) for Unit Sizes. Masonry Openings above include Sill Nose, see Trim Options page for Sill Nose specifications. For other Trim Options refer to the Unit Sizing, Rough Opening & Masonry Openings page.

SCALE: 1/8" = 1'

PICTURE UNITS WITH 29" FLANKERS

M.O. BRICKMOULD	111 1/2"(2832)	115 1/2"(2934)	123 1/2"(3137)	135 1/2"(3442)
M.O. ADAMS/FLAT CASING	114 1/2"(2908)	118 1/2"(3010)	126 1/2"(3213)	138 1/2"(3518)
ROUGH OPENING	108 7/8"(2765)	112 7/8"(2867)	120 7/8"(3070)	132 7/8"(3375)
FRAME SIZE	108 1/8"(2746)	112 1/8"(2848)	120 1/8"(3051)	132 1/8"(3356)
DAYLIGHT OPENING	23"(584)[2] 44 5/16"(1126)	23"(584)[2] 48 5/16"(1227)	23"(584)[2] 56 5/16"(1430)	23"(584)[2] 68 5/16"(1735)
51"(1295) 52 1/2"(1334) 49 1/4"(1251) 48 1/2"(1232) 19 9/16"(497)[2] 40 5/8"(1032)				
55"(1397) 56 1/2"(1495) 53 1/4"(1353) 52 1/2"(1334) 21 9/16"(557)[2] 44 5/8"(1133)				
59"(1499) 60 1/2"(1537) 57 1/4"(1454) 56 1/2"(1435) 23 9/16"(598)[2] 48 5/8"(1235)				
67"(1702) 68 1/2"(1740) 65 1/4"(1657) 64 1/2"(1638) 27 9/16"(700)[2] 46 5/8"(1193)				
71"(1803) 72 1/2"(1842) 69 1/4"(1759) 68 1/2"(1740) 29 9/16"(751)[2] 60 5/8"(1540)				
79"(2007) 80 1/2"(2045) 77 1/4"(1962) 76 1/2"(1943) 33 9/16"(852)[2] 68 5/8"(1743)				

ELEVATION SYMBOL LEGEND









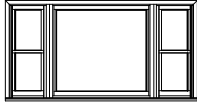
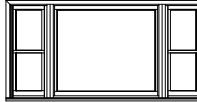
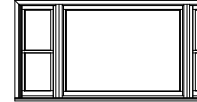
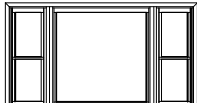

M.O. = MASONRY OPENING
 VALUES IN () ARE IN MILLIMETER CONVERSIONS
 VALUES IN [] ARE NUMBER OF DAYLIGHT OPENINGS PER UNIT
 E BASIC UNIT CLEAR OPENING EXCEEDS 20" IN WIDTH, 24" IN HEIGHT & A MINIMUM OF 5.7 SQ. FT.

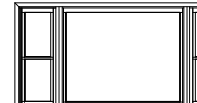
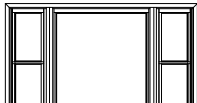
Note Elevations shown DO NOT have exterior trim. Subtract 3/4" (19) from M.O. (Masonry Opening) for Unit Sizes. Masonry Openings above include Sill Nose, see Trim Options page for Sill Nose specifications. For other Trim Options refer to the Unit Sizing, Rough Opening & Masonry Openings page.

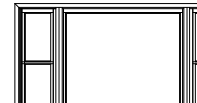
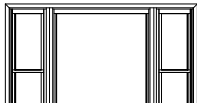
SCALE: 1/8" = 1'

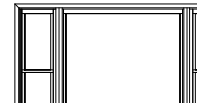
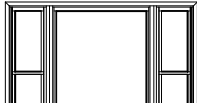
30° ANGLE BAY UNITS WITH 21" FLANKERS

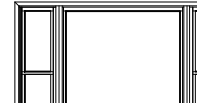
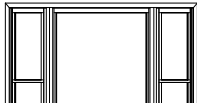
M.O. BRICKMOULD
M.O. ADAMS/FLAT CASING
ROUGH OPENING
FRAME SIZE
DAYLIGHT OPENING

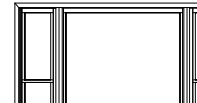
	95 3/8" (2423) 98 3/8" (2499) 91 3/4" (2330) 91 7/8" (2334)	99 3/8" (2524) 102 3/8" (2600) 95 3/4" (2432) 95 7/8" (2435)	107 3/8" (2727) 110 3/8" (2804) 103 3/4" (2635) 103 7/8" (2638)
	15" (381)[2] 44 63/64" (1143)	15" (381)[2] 48 63/64" (1244)	15" (381)[2] 56 63/64" (1447)
53 1/2" (1359) 55" (1397) 50 1/2" (1283) 50" (1270) 20 1/4" (514)[2] 40 43/64" (1033)			
	TWD3Y4948-21	TWD3Y5348-21	TWD3Y6148-21
57 1/2" (1448) 59" (1498) 54 1/2" (1384) 54" (1372) 22 1/4" (565)[2] 44 43/64" (1135)			
	TWD3Y4952-21	TWD3Y5352-21	TWD3Y6152-21
61 1/2" (1562) 63" (1600) 58 1/2" (1486) 58" (1473) 24 1/4" (618)[2] 48 43/64" (1236)			
	TWD3Y4956-21	TWD3Y5356-21	TWD3Y6156-21
69 1/2" (1765) 71" (1803) 66 1/2" (1689) 66" (1676) 28 1/4" (718)[2] 56 43/64" (1439)			
	TWD3Y4964-21	TWD3Y5364-21	TWD3Y6164-21
73 1/2" (1867) 75" (1905) 70 1/2" (1791) 70" (1778) 30 1/4" (768)[2] 60 43/64" (1541)			
	TWD3Y4968-21	TWD3Y5368-21	TWD3Y6168-21
81 1/2" (2070) 83" (2108) 78 1/2" (1994) 78" (1981) 32 15/16" (837)[2] 68 43/64" (1744)			
	TWD3Y4976-21	TWD3Y5376-21	TWD3Y6176-21

ELEVATION SYMBOL LEGEND
M.O. = MASONRY OPENING
VALUES IN () ARE IN MILLIMETER CONVERSIONS
VALUES IN [] ARE NUMBER OF DAYLIGHT OPENINGS PER UNIT

Note Elevations shown DO NOT have exterior trim. Subtract 3/4" (19) from M.O. (Masonry Opening) for Unit Sizes. Masonry Openings above include Sill Nose, see Trim Options page for Sill Nose specifications. For other Trim Options refer to the Unit Sizing, Rough Opening & Masonry Openings page.

SCALE: 1/8" = 1'

30° ANGLE BAY UNITS WITH 25" FLANKERS

M.O. BRICKMOULD M.O. ADAMS/FLAT CASING ROUGH OPENING FRAME SIZE DAYLIGHT OPENING	102 5/16" (2599) 105 5/16" (2675) 98 3/4" (2508) 98 13/16" (2510) 19" (483) [2] 44 63/64" (1143)	106 5/16" (2700) 109 5/16" (2777) 102 3/4" (2610) 102 13/16" (2611) 19" (483) [2] 48 63/64" (1244)	114 5/16" (2904) 117 5/16" (2980) 110 3/4" (2813) 110 13/16" (2815) 19" (483) [2] 56 63/64" (1447)
53 1/2" (1359) 55" (1397) 50 1/2" (1283) 50" (1270) 20 1/4" (514) [2] 40 43/64" (1033)			
57 1/2" (1448) 59" (1499) 54 1/2" (1384) 54" (1372) 22 1/4" (565) [2] 44 43/64" (1135)			
61 1/2" (1562) 63" (1600) 58 1/2" (1486) 58" (1473) 24 1/4" (616) [2] 48 43/64" (1236)			
69 1/2" (1765) 71" (1803) 66 1/2" (1689) 66" (1676) 28 1/4" (718) [2] 56 43/64" (1439)			
73 1/2" (1867) 75" (1905) 70 1/2" (1791) 70" (1778) 30 1/4" (768) [2] 60 43/64" (1541)			
81 1/2" (2070) 83" (2108) 78 1/2" (1994) 78" (1981) 32 15/16" (837) [2] 68 43/64" (1744)			

ELEVATION SYMBOL LEGEND

M.O. = MASONRY OPENING
VALUES IN () ARE IN MILLIMETER CONVERSIONS
VALUES IN [] ARE NUMBER OF DAYLIGHT OPENINGS PER UNIT
E BASIC UNIT CLEAR OPENING EXCEEDS 20" IN WIDTH, 24" IN HEIGHT & A MINIMUM OF 5.7 SQ. FT.

Note Elevations shown DO NOT have exterior trim. Subtract 3/4" (19) from M.O. (Masonry Opening) for Unit Sizes. Masonry Openings above include Sill Nose, see Trim Options page for Sill Nose specifications. For other Trim Options refer to the Unit Sizing, Rough Opening & Masonry Openings page.

SCALE: 1/8" = 1'

30° ANGLE BAY UNITS WITH 29" FLANKERS

M.O. BRICKMOULD
M.O. ADAMS/FLAT CASING
ROUGH OPENING
FRAME SIZE
DAYLIGHT OPENING

109 3/16" (2773)
112 3/16" (2850)
105 5/8" (2683)
105 11/16" (2684)
23" (584)[2] 44 63/64" (1143)

113 3/16" (2875)
116 3/16" (2951)
109 5/8" (2784)
109 11/16" (2768)
23" (584)[2] 48 63/64" (1244)

121 3/16" (3078)
124 3/16" (3154)
117 5/8" (2988)
117 11/16" (2989)
23" (584)[2] 56 63/64" (1447)

53 1/2" (1359)
55" (1397)
50 1/2" (1283)
50 1/2" (1270)
20 1/4" (514)[2]
40 43/64" (1033)

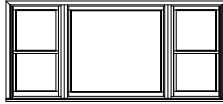

TWD3Y4948-29

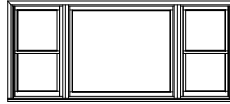

TWD3Y5348-29

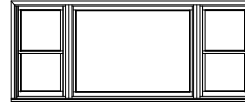

TWD3Y6148-29

57 1/2" (1448)
58" (1498)
54 1/2" (1384)
54 1/2" (1371)
22 1/4" (565)[2]
44 43/64" (1135)

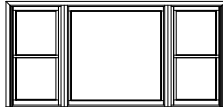

TWD3Y4952-29

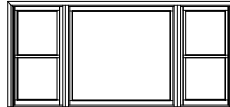

TWD3Y5352-29

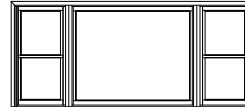

TWD3Y6152-29

61 1/2" (1562)
63" (1601)
58 1/2" (1486)
58 1/2" (1473)
24 1/4" (616)[2]
48 43/64" (1236)

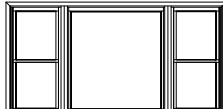

TWD3Y4956-29

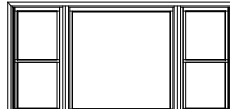

TWD3Y5356-29



TWD3Y6156-29

69 1/2" (1765)
71" (1803)
66 1/2" (1689)
66 1/2" (1676)
28 1/4" (718)[2]
56 43/64" (1439)

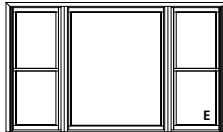

TWD3Y4964-29

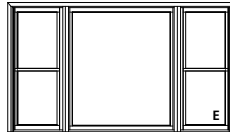

TWD3Y5364-29

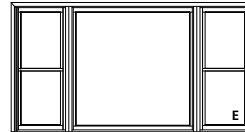

TWD3Y6164-29

73 1/2" (1867)
75" (1905)
70 1/2" (1791)
70 1/2" (1778)
30 1/4" (768)[2]
60 43/64" (1541)

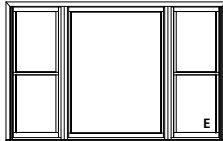

TWD3Y4968-29

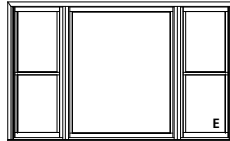

TWD3Y5368-29

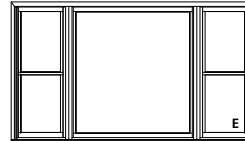

TWD3Y6168-29

81 1/2" (2070)
83" (2108)
78 1/2" (1994)
78 1/2" (1981)
32 15/16" (837)[2]
68 43/64" (1744)

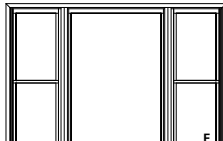

TWD3Y4976-29

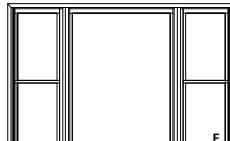

TWD3Y5376-29

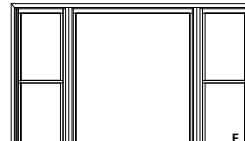

TWD3Y6176-29

ELEVATION SYMBOL LEGEND





M.O. = MASONRY OPENING
VALUES IN () ARE IN MILLIMETER CONVERSIONS
VALUES IN [] ARE NUMBER OF DAYLIGHT OPENINGS PER UNIT
E = BASIC UNIT CLEAR OPENING EXCEEDS 20" IN WIDTH, 24" IN HEIGHT & A MINIMUM OF 5.7 SQ. FT.

Note Elevations shown DO NOT have exterior trim. Subtract 3/4" (19) from M.O. (Masonry Opening) for Unit Sizes. Masonry Openings above include Sill
Note, see Trim Options page for Sill Nose specifications. For other Trim Options refer to the Unit Sizing, Rough Opening & Masonry Openings page.

SCALE: 1/8" = 1'

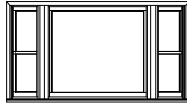
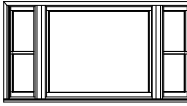
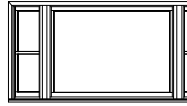
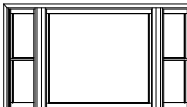
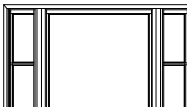
45° ANGLE BAY UNITS WITH 21" FLANKERS

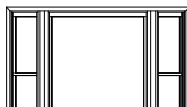
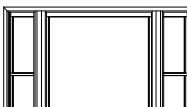
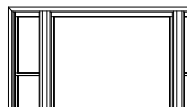
**M.O. BRICKMOUND
M.O. ADAMS/FLAT CASING
ROUGH OPENING
FRAME SIZE
DAYLIGHT OPENING**

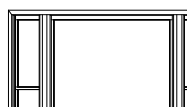
89 9/16" (2275) 92 9/16" (2351) 85 1/4" (2165) 86 1/16" (2186) 15" (381)[2] 45 45/64" (1161)	93 9/16" (2376) 96 9/16" (2453) 89 1/4" (2267) 90 1/16" (2288) 15" (381)[2] 49 45/64" (1262)	101 9/16" (2579) 104 9/16" (2656) 97 1/4" (2470) 98 1/16" (2491) 15" (381)[2] 57 45/64" (1466)	
53 1/2" (1359) 55" (1397) 56 7/16" (1428) 50" (1270) 20 1/4" (514) 40 43/64" (1033)			
TWD4Y4948-21	TWD4Y5348-21	TWD4Y6148-21	
57 1/2" (1448) 59" (1499) 54 1/2" (1384) 54" (1372) 22 1/4" (565) 44 43/64" (1135)			
TWD4Y4952-21	TWD4Y5352-21	TWD4Y6152-21	
61 1/2" (1562) 63" (1600) 58 1/2" (1486) 59" (1493) 24 1/4" (616) 48 43/64" (1236)			
TWD4Y4956-21	TWD4Y5356-21	TWD4Y6156-21	
69 1/2" (1765) 71" (1803) 66 1/2" (1689) 66" (1677) 28 1/4" (718) 56 43/64" (1439)			
TWD4Y4964-21	TWD4Y5364-21	TWD4Y6164-21	
73 1/2" (1867) 75" (1905) 70 1/2" (1771) 70" (1759) 30 1/4" (768) 60 43/64" (1541)			
TWD4Y4968-21	TWD4Y5368-21	TWD4Y6168-21	
81 1/2" (2070) 83" (2108) 78 1/2" (1984) 78" (1981) 32 15/16" (837) 68 43/64" (1744)			
TWD4Y4976-21	TWD4Y5376-21	TWD4Y6176-21	

ELEVATION SYMBOL LEGEND
M.O. = MASONRY OPENING
VALUES IN () ARE IN MILLIMETER CONVERSIONS
VALUES IN [] ARE NUMBER OF DAYLIGHT OPENINGS PER UNIT

Note Elevations shown DO NOT have exterior trim. Subtract 3/4" (19) from M.O. (Masonry Opening) for Unit Sizes. Masonry Openings above include Sill Nose, see Trim Options page for Sill Nose specifications. For other Trim Options refer to the Unit Sizing, Rough Opening & Masonry Openings page.

SCALE: 1/8" = 1'

45° ANGLE BAY UNITS WITH 25" FLANKERS

M.O. BRICKMOULD
M.O. ADAMS/FLAT CASING
ROUGH OPENING
FRAME SIZE
DAYLIGHT OPENING

95 1/2" (2426)	99 1/2" (2527)	107 1/2" (2731)
98 1/2" (2502)	102 1/2" (2604)	110 1/2" (2807)
90 15/16" (2310)	94 15/16" (2411)	102 15/16" (2613)
91 3/4" (2330)	95 3/4" (2432)	103 3/4" (2635)
19" (483) [2] 51 35/64" (1309)	19" (483) [2] 55 35/64" (1411)	19" (483) [2] 63 35/64" (1614)
53 1/2" (1359)		
55" (1397)		
50 1/2" (1283)		
50" (1270)		
20 1/4" (514) [2]		
40 43/64" (1033)		
TWD4Y4948-25	TWD4Y5348-25	TWD4Y6148-25
57 1/2" (1448)		
59" (1499)		
54 1/2" (1384)		
54" (1372)		
22 1/4" (565) [2]		
44 43/64" (1135)		
TWD4Y4952-25	TWD4Y5352-25	TWD4Y6152-25
61 1/2" (1562)		
63" (1600)		
58 1/2" (1486)		
58" (1473)		
24 1/4" (616) [2]		
48 43/64" (1236)		
TWD4Y4956-25	TWD4Y5356-25	TWD4Y6156-25
69 1/2" (1765)		
71" (1803)		
66 1/2" (1689)		
66" (1676)		
28 1/4" (718) [2]		
56 43/64" (1439)		
TWD4Y4964-25	TWD4Y5364-25	TWD4Y6164-25
73 1/2" (1867)		
75" (1905)		
70 1/2" (1791)		
70" (1778)		
30 1/4" (768) [2]		
60 43/64" (1541)		
TWD4Y4968-25	TWD4Y5368-25	TWD4Y6168-25
81 1/2" (2070)		
83" (2108)		
78 1/2" (1994)		
78" (1981)		
32 15/16" (837) [2]		
68 43/64" (1744)		
TWD4Y4976-25	TWD4Y5376-25	TWD4Y6176-25

ELEVATION SYMBOL LEGEND

M.O. = MASONRY OPENING
VALUES IN () ARE IN MILLIMETER CONVERSIONS
VALUES IN [] ARE NUMBER OF DAYLIGHT OPENINGS PER UNIT
E = BASIC UNIT CLEAR OPENING EXCEEDS 20" IN WIDTH, 24" IN HEIGHT & A MINIMUM OF 5.7 SQ. FT.

Note Elevations shown DO NOT have exterior trim. Subtract 3/4" (19) from M.O. (Masonry Opening) for Unit Sizes. Masonry Openings above include Sill Nose, see Trim Options page for Sill Nose specifications. For other Trim Options refer to the Unit Sizing, Rough Opening & Masonry Openings page.

SCALE: 1/8" = 1'

45° ANGLE BAY UNITS WITH 29" FLANKERS

**M.O. BRICKMOUND
M.O. ADAMS/FLAT CASING
ROUGH OPENING
FRAME SIZE
DAYLIGHT OPENING**

	100 7/8" (2562) 103 7/8" (2638) 96 1/2" (2451) 97 3/8" (2473) 23" (584)[2] 45 45/64" (1161)	104 7/8" (2664) 107 7/8" (2740) 100 1/2" (2553) 101 3/8" (2575) 23" (584)[2] 49 45/64" (1262)	112 7/8" (2867) 115 7/8" (2943) 108 1/2" (2756) 109 3/8" (2778) 23" (584)[2] 57 45/64" (1466)
53 1/2" (1359) 55" (1397) 50 1/2" (1283) 50" (1270) 20 1/4" (514)[2] 40 43/64" (1033)			
TWD4Y4948-29	TWD4Y5348-29	TWD4Y6148-29	
57 1/2" (1448) 59" (1499) 54 1/2" (1384) 54" (1372) 22 1/4" (565)[2] 44 43/64" (1135)			
TWD4Y4952-29	TWD4Y5352-29	TWD4Y6152-29	
61 1/2" (1562) 63" (1600) 58 1/2" (1486) 58" (1473) 24 1/4" (616)[2] 48 43/64" (1236)			
TWD4Y4956-29	TWD4Y5356-29	TWD4Y6156-29	
69 1/2" (1765) 71" (1803) 66 1/2" (1689) 66" (1676) 28 1/4" (718)[2] 56 43/64" (1439)			
TWD4Y4964-29	TWD4Y5364-29	TWD4Y6164-29	
73 1/2" (1867) 75" (1905) 70 1/2" (1791) 70" (1778) 30 1/4" (768)[2] 60 43/64" (1541)			
TWD4Y4968-29	TWD4Y5368-29	TWD4Y6168-29	
81 1/2" (2070) 83" (2108) 78 1/2" (1994) 78" (1981) 32 15/16" (837)[2] 68 43/64" (1744)			
TWD4Y4976-29	TWD4Y5376-29	TWD4Y6176-29	

ELEVATION SYMBOL LEGEND

M.O. = MASONRY OPENING
VALUES IN () ARE IN MILLIMETER CONVERSIONS
VALUES IN [] ARE NUMBER OF DAYLIGHT OPENINGS PER UNIT
E BASIC UNIT CLEAR OPENING EXCEEDS 20" IN WIDTH, 24" IN HEIGHT & A MINIMUM OF 5.7 SQ. FT.

Note Elevations shown DO NOT have exterior trim. Subtract 3/4" (19) from M.O. (Masonry Opening) for Unit Sizes. Masonry Openings above include Sill Nose, see Trim Options page for Sill Nose specifications. For other Trim Options refer to the Unit Sizing, Rough Opening & Masonry Openings page.

SCALE: 1/8" = 1'

ELEVATION NOTES
DOUBLE-HUNG TRANSOM

ELEVATION DRAWINGS UTILIZE A LIMITED NUMBER OF PROJECTED LINES TO PRODUCE A RUDIMENTARY DRAWING INTENDED TO BE USED IN A SMALL GRAPHICAL SCALE. ELEVATIONS ARE VIEWED PERPENDICULAR FROM THE EXTERIOR OF THE STRUCTURE. IF MORE DIMENSIONS ARE NEEDED, USE THE SECTION DRAWINGS FOR MORE COMPLETE DEPICTIONS.

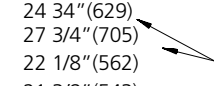
M.O. Brickmould	24 3/4" (629)	 <p>Masonry Openings for Brickmould, Flat & Adams Casing. Vertical measurements include sillnose. (Subtract 1/2" from Masonry Opening for Unit Size)</p>
M.O. Adams/Flat Casing	27 3/4" (705)	
Rough Opening	22 1/8" (562)	
Frame Size	21 3/8" (543)	
Daylight Opening	16 5/16" (414)	

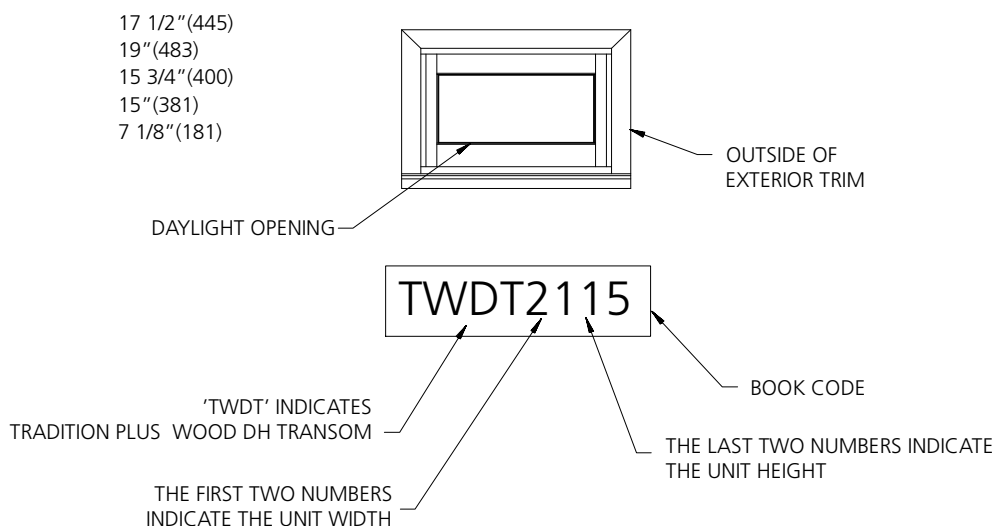

GENERAL DOUBLE HUNG TRANSOM NOTES

1. ALL UNITS SHOWN ARE AVAILABLE AS STATIONARY ONLY.
2. UNIT ELEVATIONS ARE SHOWN WITH BRICKMOULD & SILLNOSE.
3. DIMENSIONAL VALUES IN PARENTHESES ARE MILLIMETER CONVERSIONS.

ELEVATION SYMBOL LEGEND:

MO MASONRY OPENING

TRANSOM UNITS

M.O. BRICKMOULD	24 3/4"(629)	28 3/4"(730)	32 3/4"(832)	36 3/4"(933)	40 3/4"(1035)	44 3/4"(1137)	46 1/8"(1172)
M.O. ADAMS/FLAT CASING	27 3/4"(705)	31 3/4"(806)	35 3/4"(908)	39 3/4"(1010)	43 3/4"(1111)	47 3/4"(1213)	49 1/8"(1248)
ROUGH OPENING	22 1/8"(562)	26 1/8"(664)	30 1/8"(765)	34 1/8"(867)	38 1/8"(968)	42 1/8"(1070)	43 1/2"(1105)
FRAME SIZE	21 3/8"(543)	25 3/8"(645)	29 3/8"(746)	33 3/8"(848)	37 3/8"(949)	41 3/8"(1051)	42 3/4"(1086)
DAYLIGHT OPENING	16 5/16"(414)	20 5/16"(515)	24 5/16"(618)	28 5/16"(719)	32 5/16"(821)	36 5/16"(922)	37 11/16"(957)
17 1/2"(445) 19"(483) 15 3/4"(400) 15"(381) 7 1/8"(181)							
20 1/2"(521) 22"(559) 18 3/4"(476) 18"(457) 10 1/8"(267)							
26 1/2"(673) 28"(711) 24 3/4"(629) 24"(610) 17 1/8"(435)							
38 1/2"(978) 40"(1016) 36 3/4"(933) 36"(914) 28 1/8"(714)							

M.O. BRICKMOULD	48 3/4"(1238)	52 3/4"(1340)	54 1/8"(1375)	56 3/4"(1441)	62 1/8"(1578)
M.O. ADAMS/FLAT CASING	51 3/4"(1314)	55 3/4"(1416)	57 1/8"(1451)	59 3/4"(1518)	65 1/8"(1654)
ROUGH OPENING	46 1/8"(1172)	50 1/8"(1273)	51 1/2"(1308)	54 1/8"(1375)	59 1/2"(1511)
FRAME SIZE	45 3/8"(1153)	49 3/8"(1254)	50 3/4"(1289)	53 3/8"(1356)	58 3/4"(1492)
DAYLIGHT OPENING	40 5/16"(1024)	44 5/16"(1126)	45 11/16"(1160)	48 5/16"(1227)	53 11/16"(1364)
17 1/2"(445) 19"(483) 15 3/4"(400) 15"(381) 7 1/8"(181)					
20 1/2"(521) 22"(559) 18 3/4"(476) 18"(457) 10 1/8"(267)					
26 1/2"(673) 28"(711) 24 3/4"(629) 24"(610) 17 1/8"(435)					
38 1/2"(978) 40"(1016) 36 3/4"(933) 36"(914) 28 1/8"(714)					

ELEVATION SYMBOL LEGEND
M.O. = MASONRY OPENING
 VALUES IN () ARE IN MILLIMETER CONVERSIONS

Note Elevations shown DO NOT have exterior trim. Subtract 3/4" (19) from M.O. (Masonry Opening) for Unit Sizes. Masonry Openings above include Sill Nose, see Trim Options page for Sill Nose specifications. For other Trim Options refer to the Unit Sizing, Rough Opening & Masonry Openings page.

SCALE: 1/4" = 1'

TRANSOM UNITS

M.O. BRICKMOULD
M.O. ADAMS/FLAT CASING
ROUGH OPENING
FRAME SIZE
DAYLIGHT OPENING

64 3/4"(1645)
67 3/4"(1721)
62 1/8"(1578)
61 3/8"(1559)
56 5/16"(1430)

70 1/8"(1781)
73 1/8"(1857)
67 1/2"(1715)
66 3/4"(1695)
61 11/16"(1541)

76 3/4"(1949)
79 3/4"(2026)
74 1/8"(1883)
73 3/8"(1864)
68 5/16"(1735)

17 1/2"(445)
19"(483)
15 3/4"(400)
15"(381)
7 1/8"(181)



TWDT6115



TWDT6615



TWDT7315

20 1/2"(521)
22"(559)
18 3/4"(476)
18"(457)
10 1/8"(527)



TWDT6118



TWDT6618



TWDT7318

26 1/2"(673)
28"(711)
24 3/4"(629)
24"(610)
17 1/8"(435)



TWDT6124



TWDT6624



TWDT7324

38 1/2"(978)
40"(1016)
36 3/4"(933)
36"(914)
28 1/8"(714)

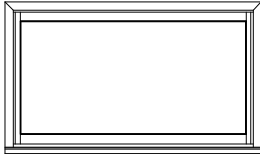

TWDT6136

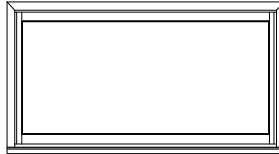

TWDT6636

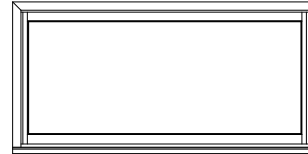

TWDT7336

M.O. BRICKMOULD
M.O. ADAMS/FLAT CASING
ROUGH OPENING
FRAME SIZE
DAYLIGHT OPENING

78 1/8"(1984)
81 1/8"(2061)
75 1/2"(1918)
74 3/4"(1899)
69 11/16"(1770)

17 1/2"(445)
19"(483)
15 3/4"(400)
15"(381)
7 1/8"(181)



TWDT7415

20 1/2"(521)
22"(559)
18 3/4"(476)
18"(457)
10 1/8"(527)

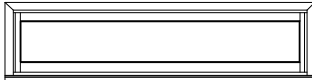

TWDT7418

26 1/2"(673)
28"(711)
24 3/4"(629)
24"(610)
17 1/8"(435)

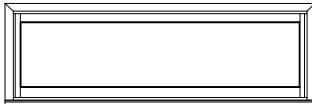

TWDT7424

38 1/2"(978)
40"(1016)
36 3/4"(933)
36"(914)
28 1/8"(714)

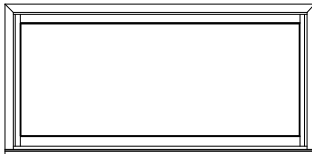

TWDT7436

ELEVATION SYMBOL LEGEND

M.O. = MASONRY OPENING
VALUES IN () ARE IN MILLIMETER CONVERSIONS

Note Elevations shown DO NOT have exterior trim. Subtract 3/4" (19) from M.O. (Masonry Opening) for Unit Sizes. Masonry Openings above include Sill Nose, see Trim Options page for Sill Nose specifications. For other Trim Options refer to the Unit Sizing, Rough Opening & Masonry Openings page.

SCALE: 1/4" = 1'

GLAZING OPTIONS

INTERIOR GLAZING

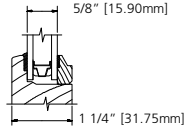

DH INSULATED GLASS

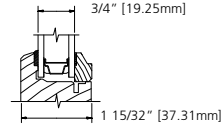

DH PICTURE INSULATED GLASS

TRIM OPTIONS

EXTERIOR TRIM

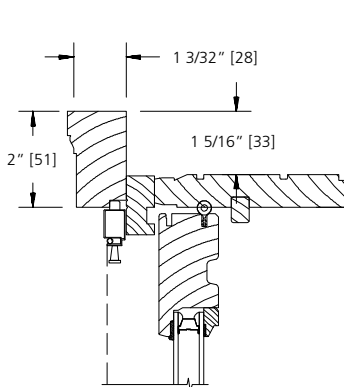

BRICKMOLD

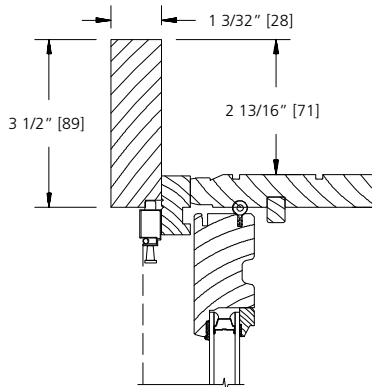

3 1/2" FLAT CASING

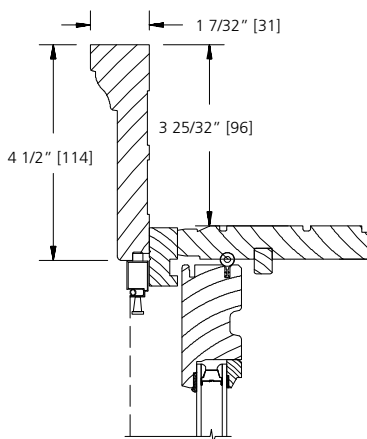

1 X 4 BACKBAND

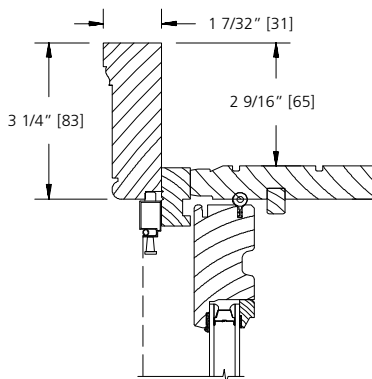

WILLIAMSBURG

SILL OPTIONS

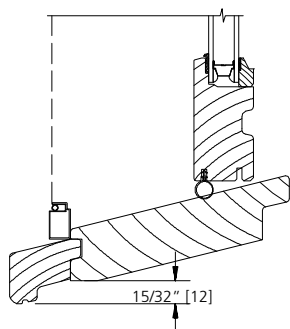

STANDARD

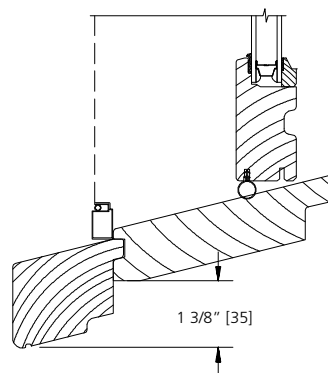

2" NOSING

SCALE: 3" = 1'

JAMB EXTENDER OPTIONS

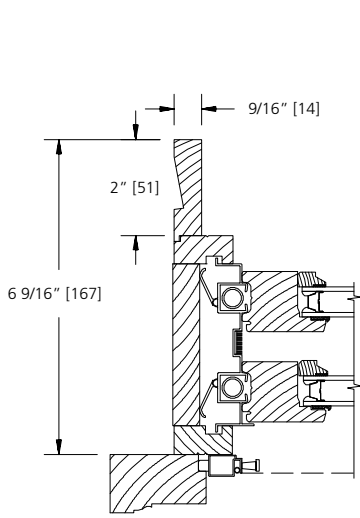

6 9/16" WALL
9/16" JAMB THICKNESS
(OPTION)

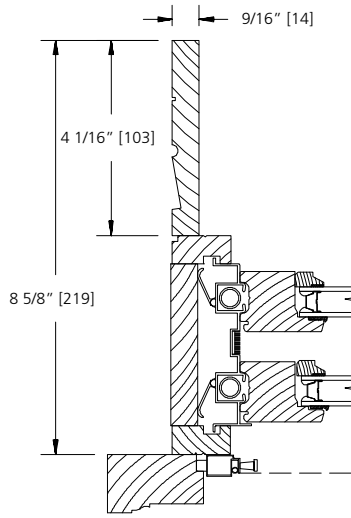

8 5/8" WALL

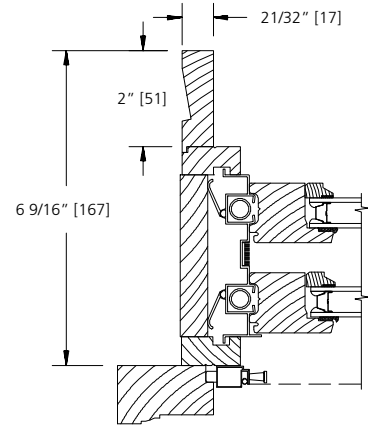

6 9/16" WALL
4/4 JAMB THICKNESS
(STANDARD)

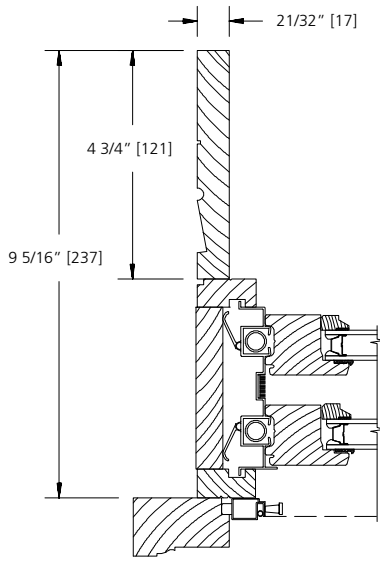

9 5/16" WALL

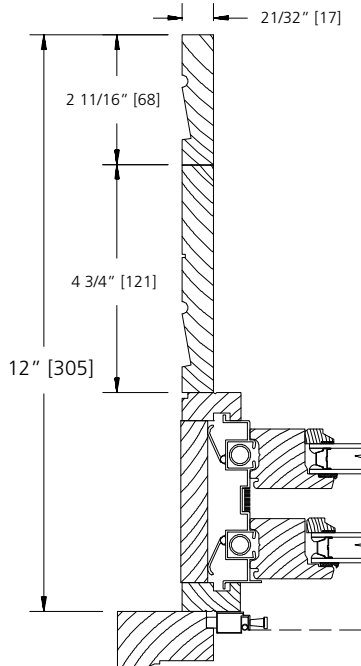

12" WALL
4/4 JAMB THICKNESS
(STANDARD)
2 PC JAMB EXTENSION SHOWN

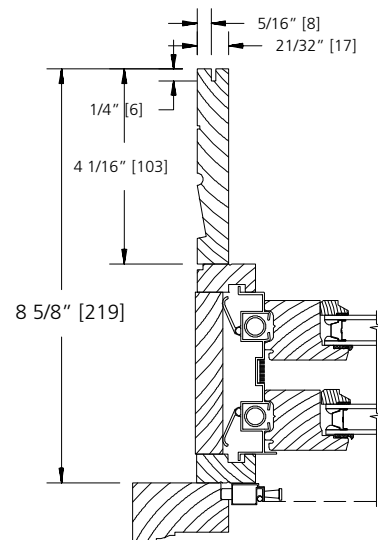

8 5/8" WALL
4/4 JAMB THICKNESS
(STANDARD)
KERFED EXTENSION SHOWN

SCALE: 3" = 1'

STANDARD MULLION OPTIONS

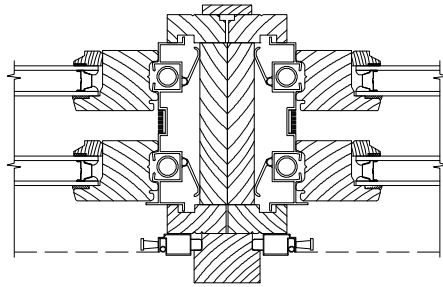

TWIN OPERATING DOUBLE HUNG

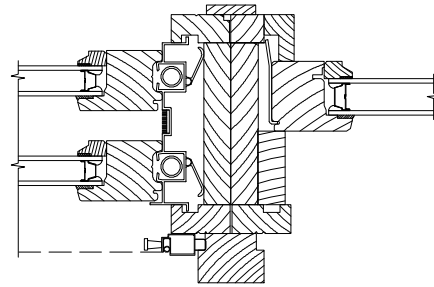

**DOUBLE HUNG WITH
DOUBLE HUNG PICTURE**

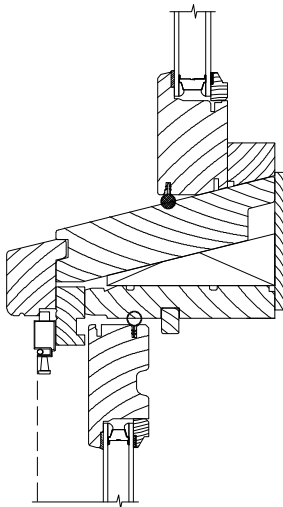

**DOUBLE HUNG TRANSOM
OVER DOUBLE HUNG**

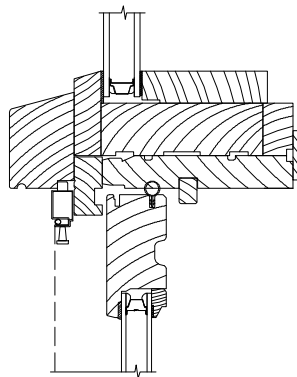

**DIRECT SET GEOMETRIC
OVER DOUBLE HUNG**

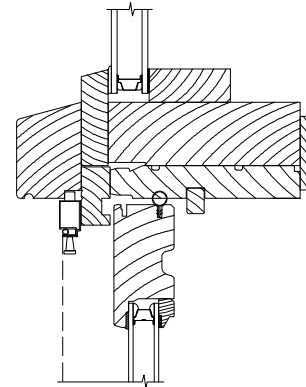

**DIRECT SET RADIUS
OVER DOUBLE HUNG**

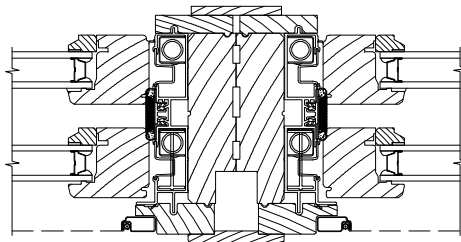

TWIN OPERATING POCKET DOUBLE-HUNG

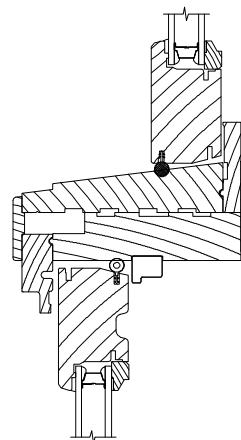

**FIXED
OVER POCKET DOUBLE-HUNG**

SCALE: 3" = 1'

STANDARD MULLION OPTIONS

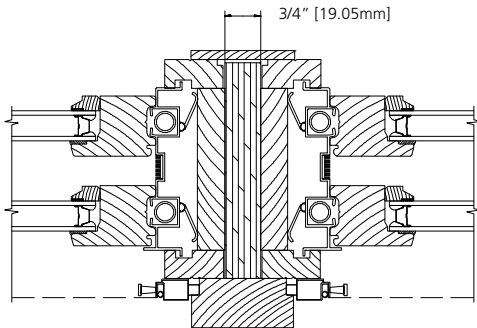

3/4" WOOD SPREAD MULLION

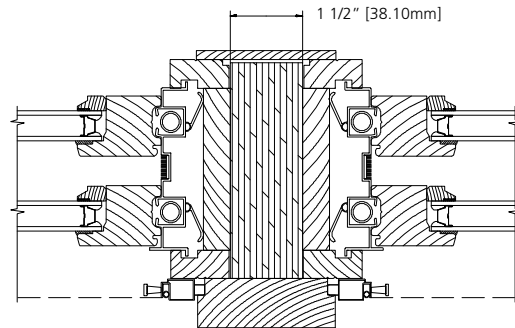

1 1/2" WOOD SPREAD MULLION

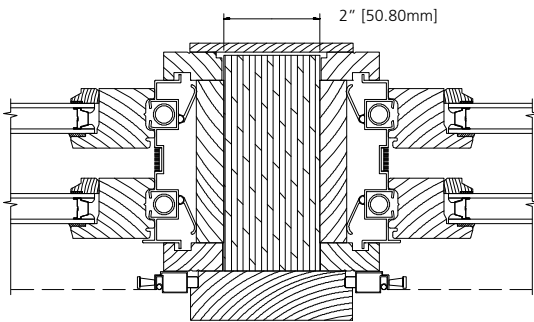

2" WOOD SPREAD MULLION

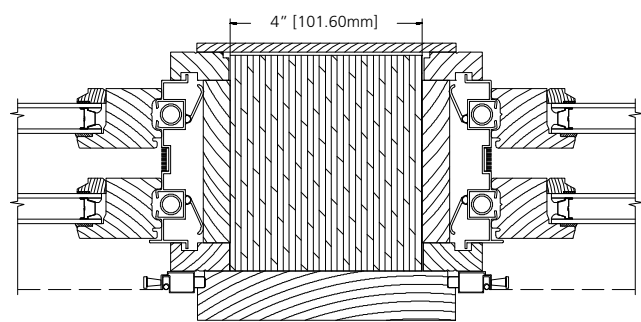

4" WOOD SPREAD MULLION

LITE CUT INFORMATION

Wood double-hung windows are available with removable grilles in 7/8", 1-1/8" and 1-3/8" widths, grilles between glass (GBG), and Simulated Divided Lites. Standard lite cuts are rectangular.

LITE CUT OPTIONS

Special lite cut patterns can include a wide variety of straight line and radius patterns. The illustrations shown here represent just a few of the possibilities. Rectangular, horizontal, vertical and Prairie lite patterns are available in all standard size wood double-hung windows. Uneven, diamonds radius and Gothic lite cuts are available, subject to approval. Approvals are based on the ability to fulfill the design requirement while maintaining the construction integrity of the finished product.

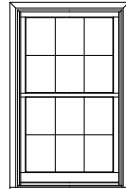

RECTANGULAR

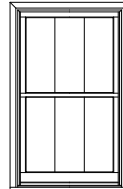

VERTICAL

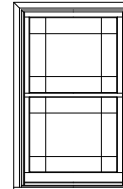

PRAIRIE

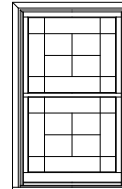

UNEVEN

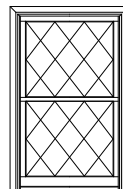

DIAMOND

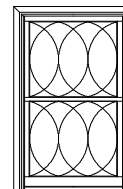

RADIUS

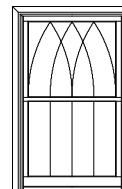

GOTHIC

BAR ALIGNMENT

Alignment of divided lite muntin bars from one window to the next is often required by fine architectural design. Wood grilles, GBG (Grilles between the Glass), and Simulated Divided Lites may be specified with muntin bars aligned.

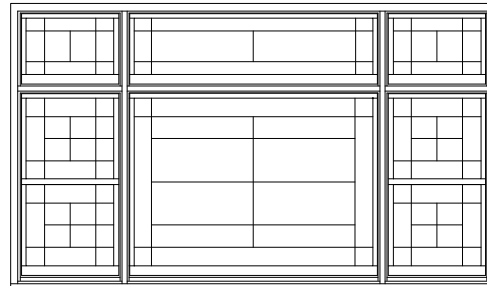

DIVIDED LITE OPTIONS

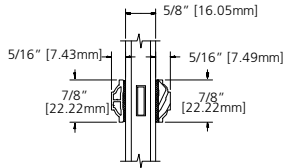

7/8" SDL

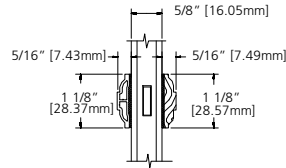

1 1/8" SDL

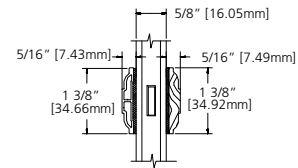

1 3/8" SDL

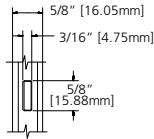

5/8" GRILLE

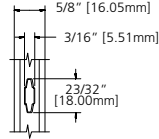

23/32" GRILLE

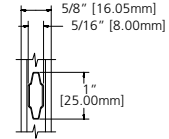

1" GRILLE

**UNIT SIZING, ROUGH OPENINGS
& MASONRY OPENINGS
DOUBLE-HUNG**

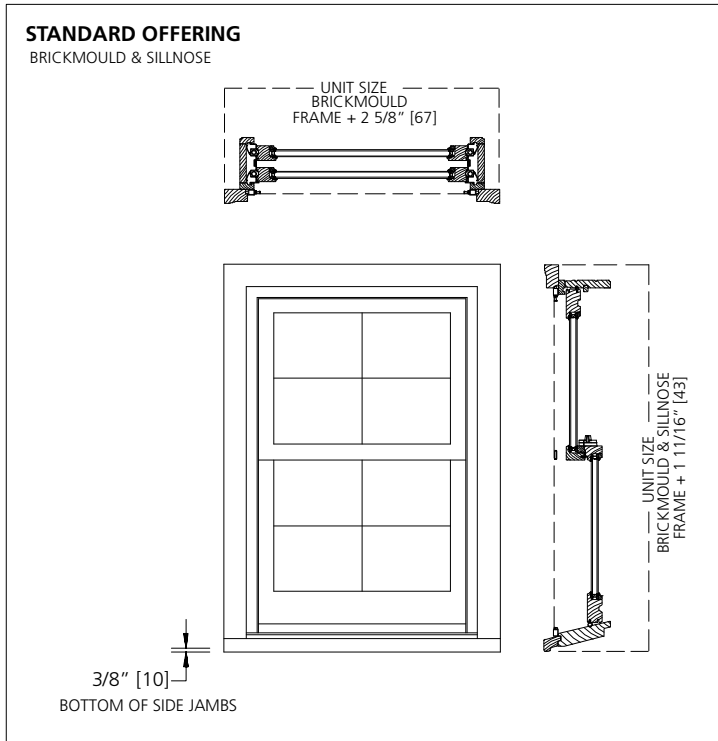

GENERAL NOTES:

UNITS WITH NO TRIM AND SILL NOSE:
UNIT SIZE = FRAME SIZE

UNIT SIZE IS ALWAYS THE
EXTREME SIZE OF THE WINDOW
WITH OR WITHOUT TRIM

MASONRY OPENING:
MASONRY OPENING IS ALWAYS 1/2" OVER
THE UNIT SIZE OF THE WINDOW

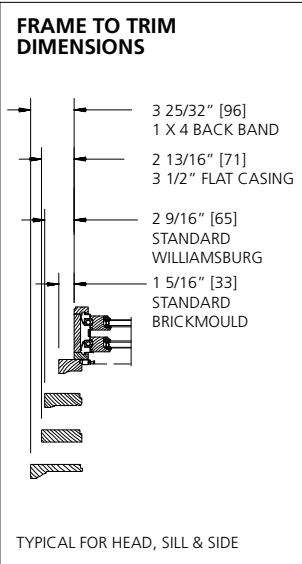
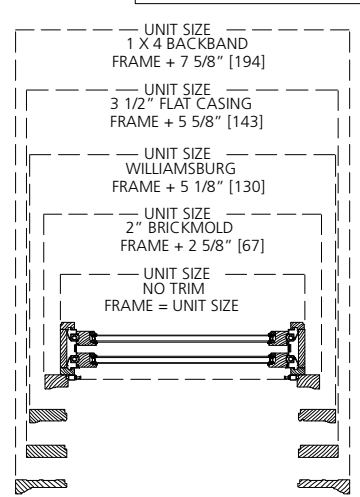
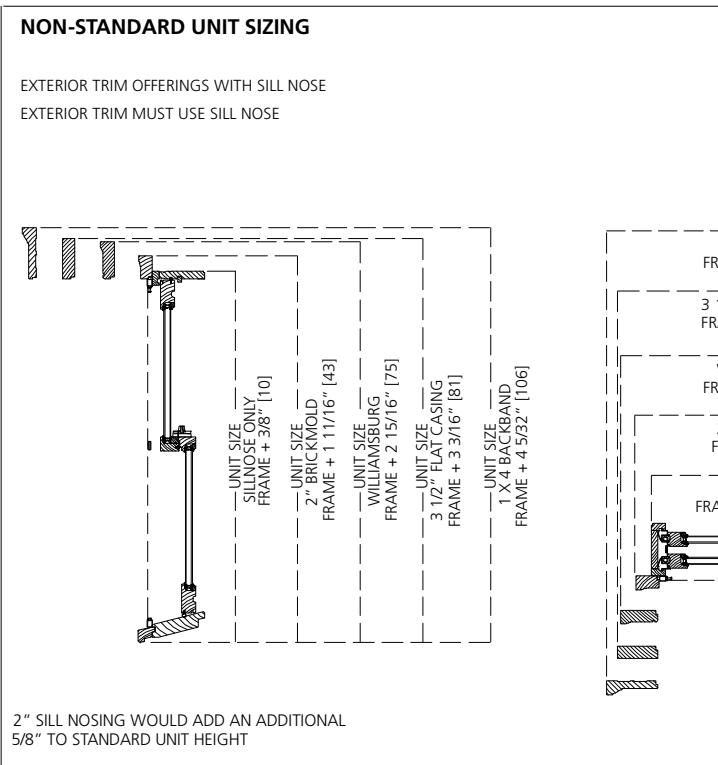
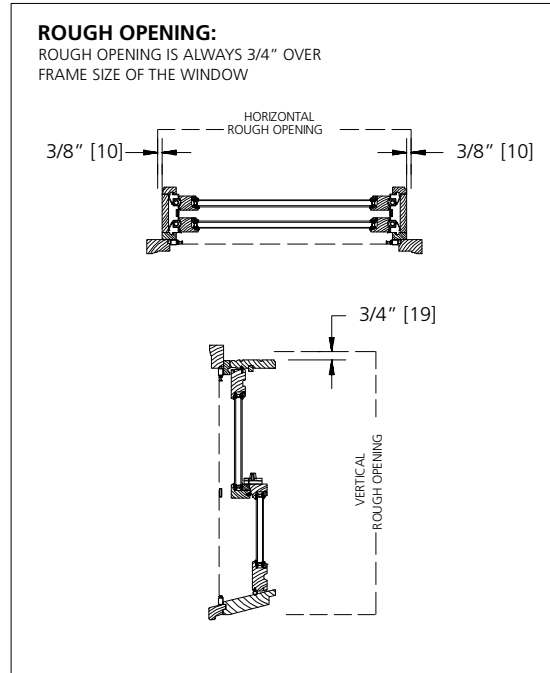

1-WIDE UNIT

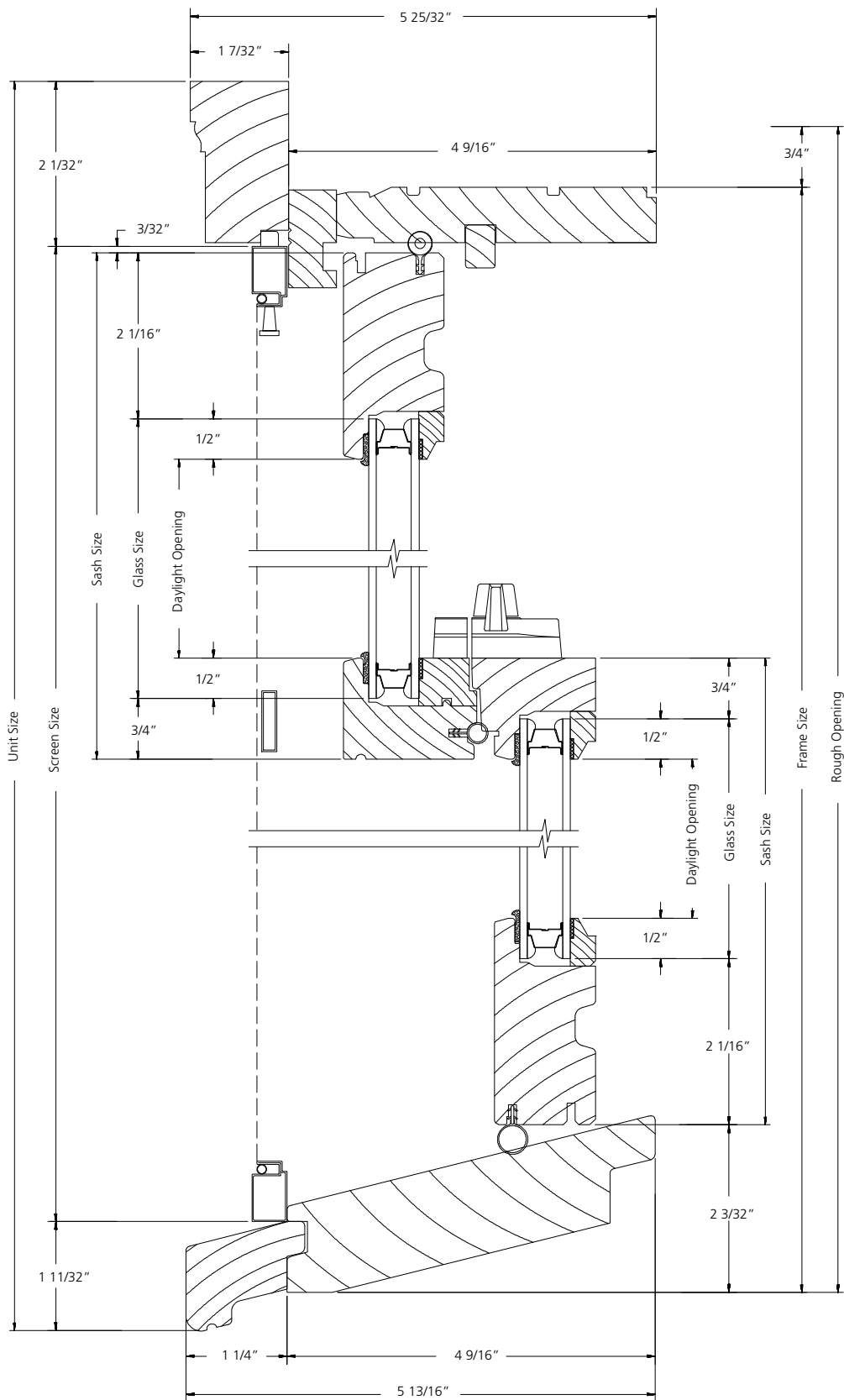

VERTICAL SECTION

SCALE: 6" = 1'

1-WIDE UNIT

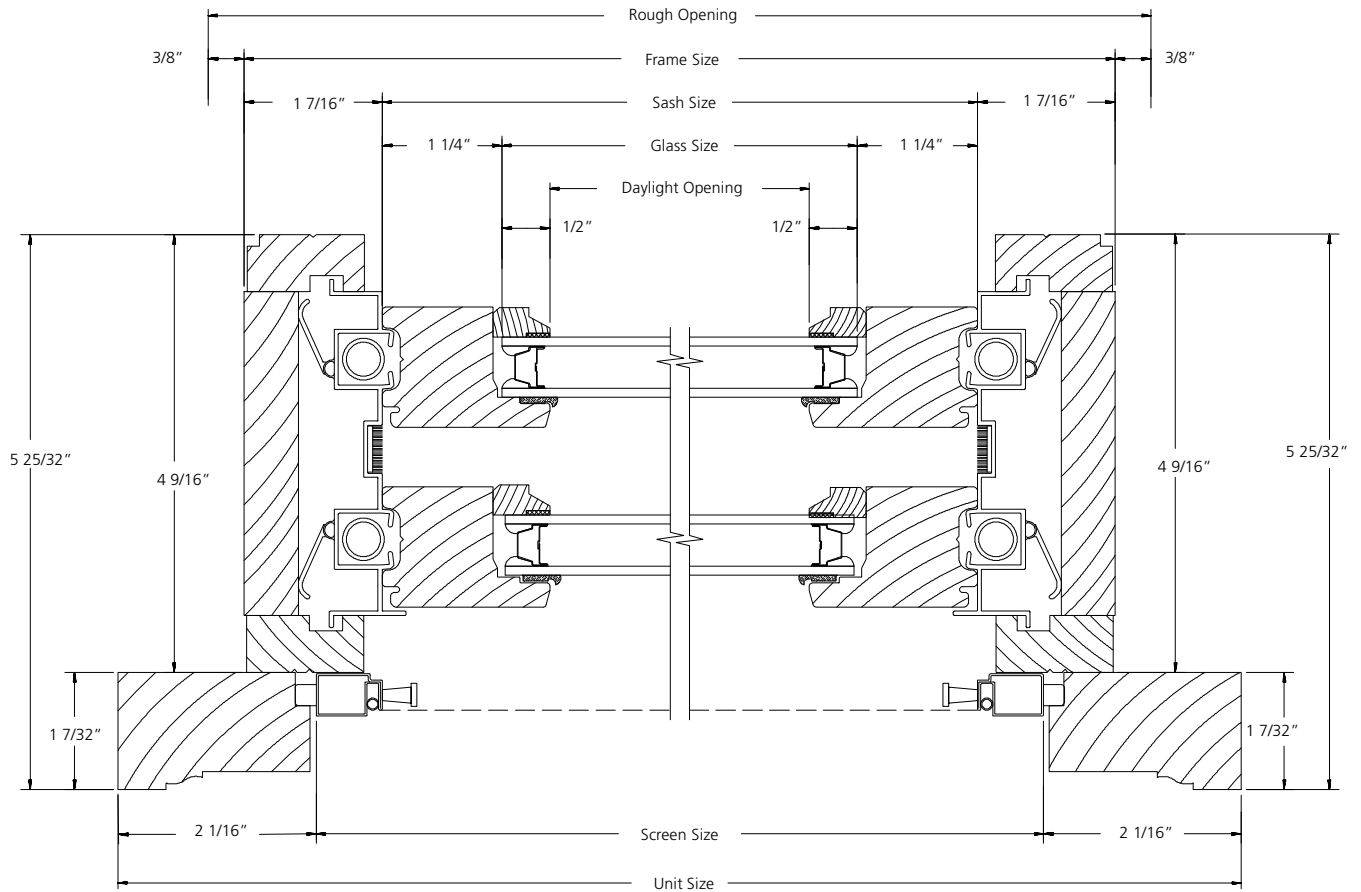

HORIZONTAL SECTION

SCALE: 6" = 1'

2-WIDE UNIT

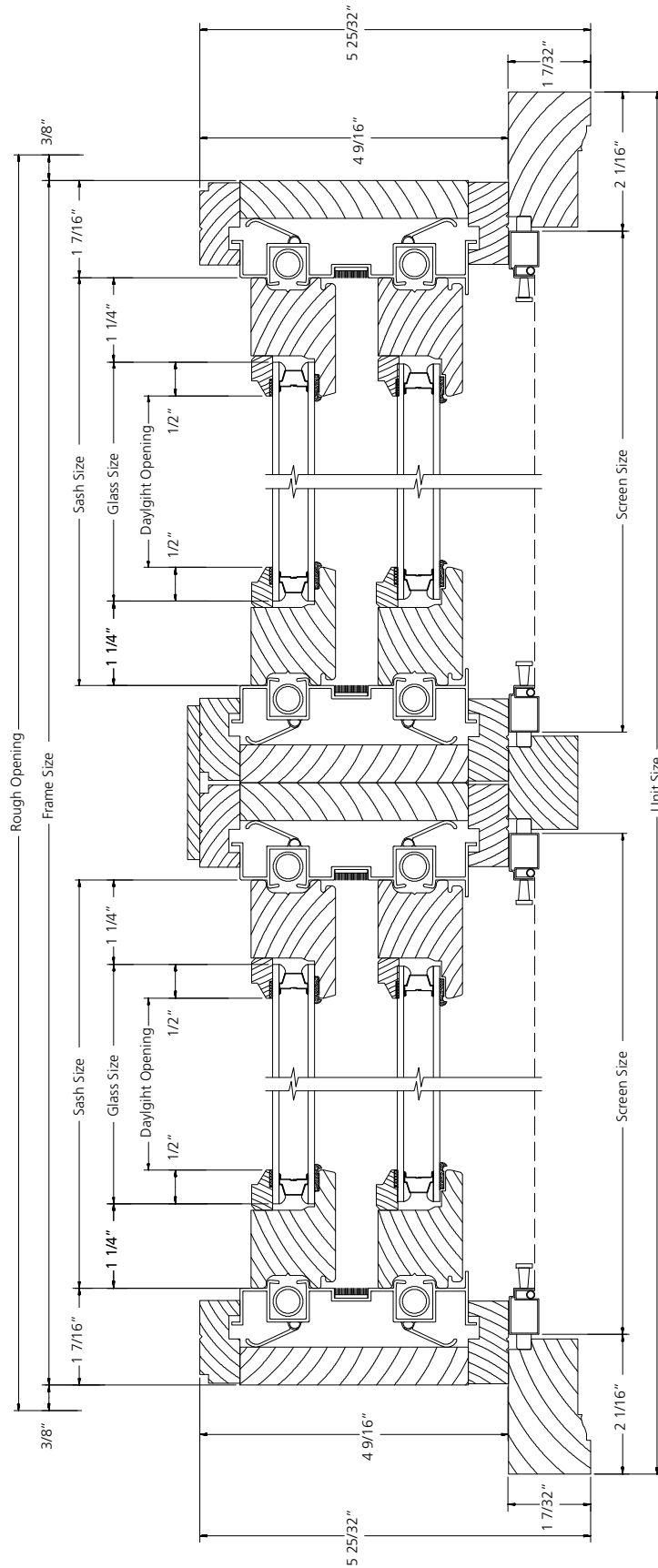

HORIZONTAL SECTION

SCALE: 6" = 1'

COMBINATION UNIT

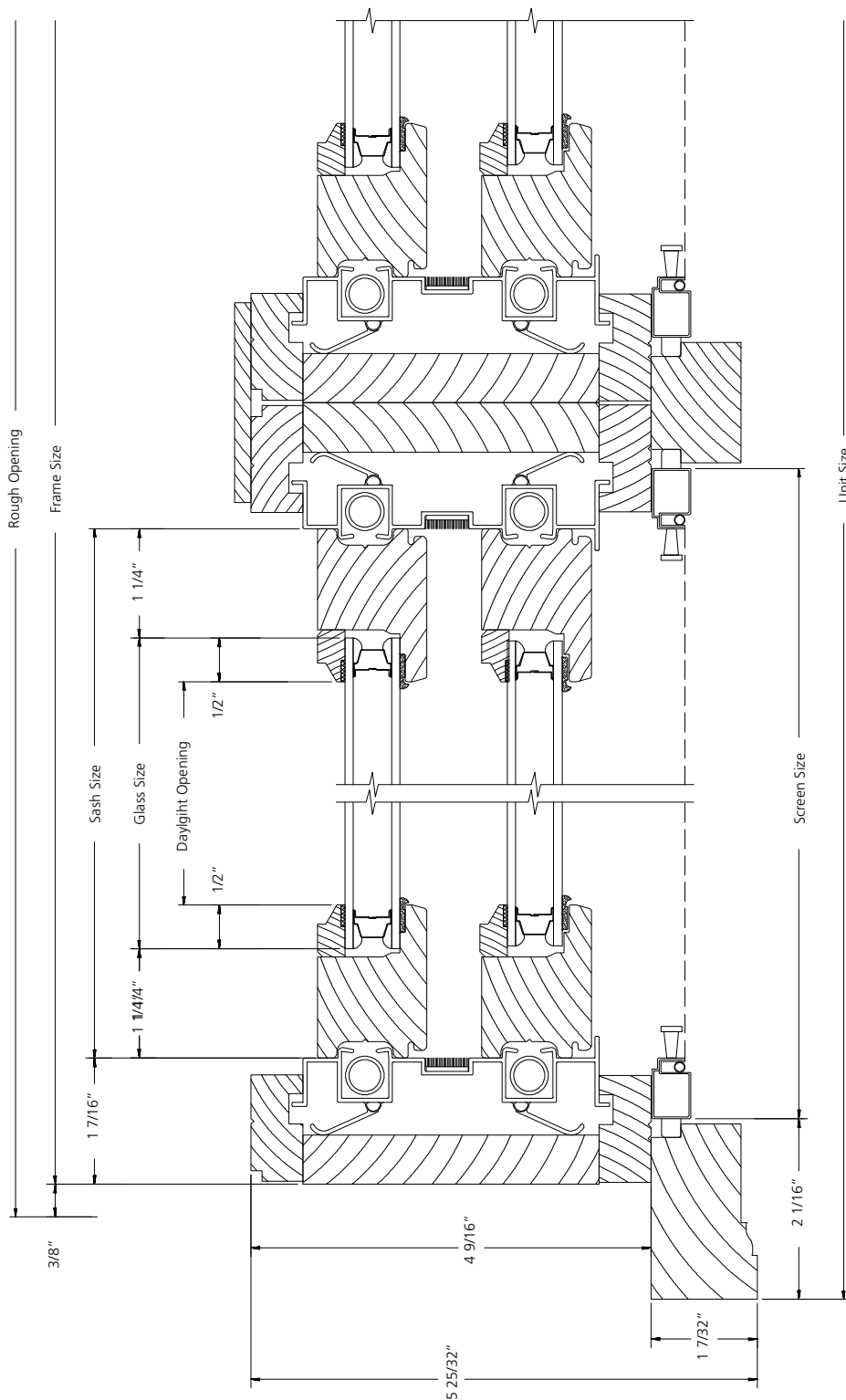

HORIZONTAL SECTION

SCALE: 6" = 1'

PICTURE UNIT

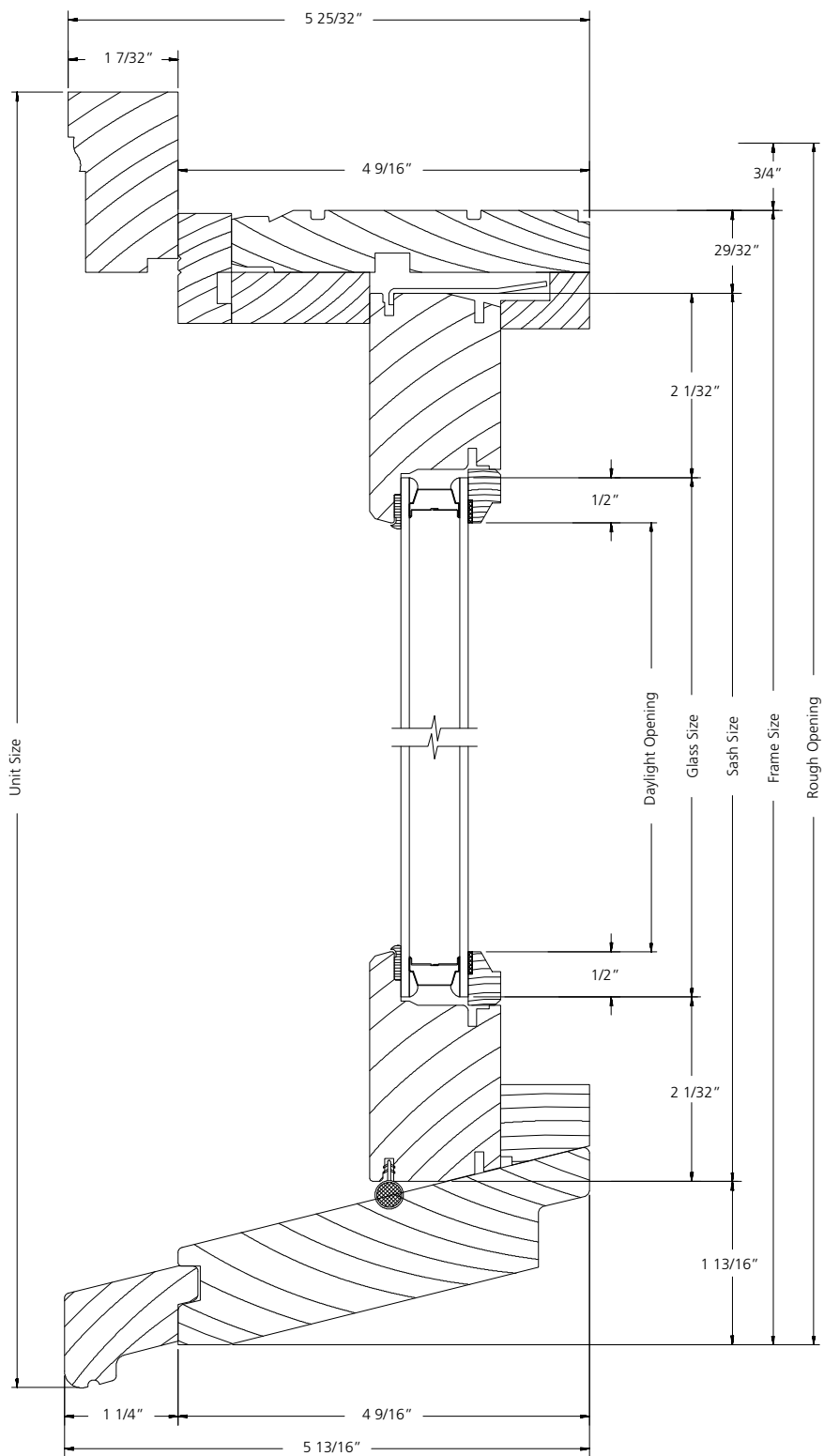

VERTICAL SECTION

SCALE: 6" = 1'

PICTURE UNIT

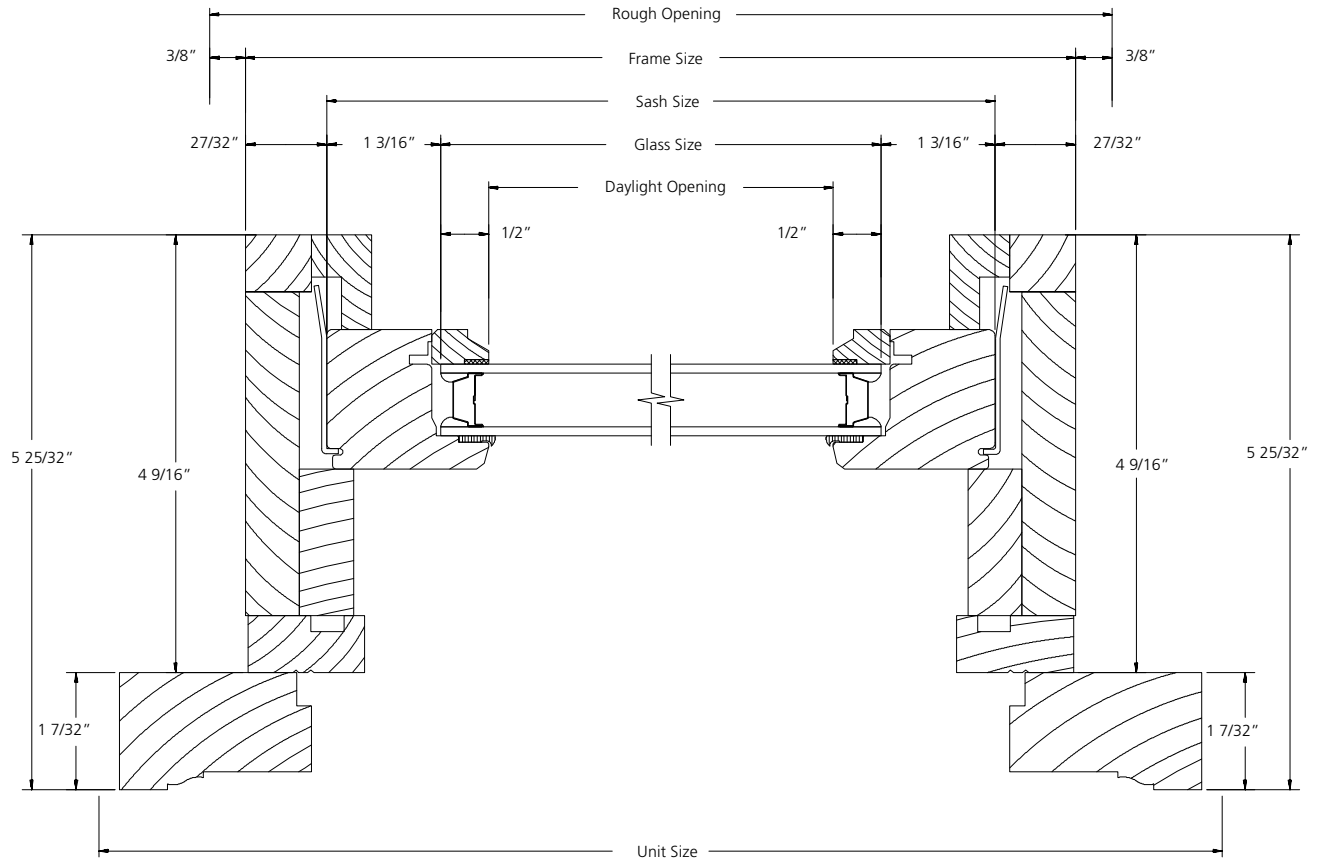

HORIZONTAL SECTION

SCALE: 6" = 1'

PICTURE UNIT WITH FLANKERS

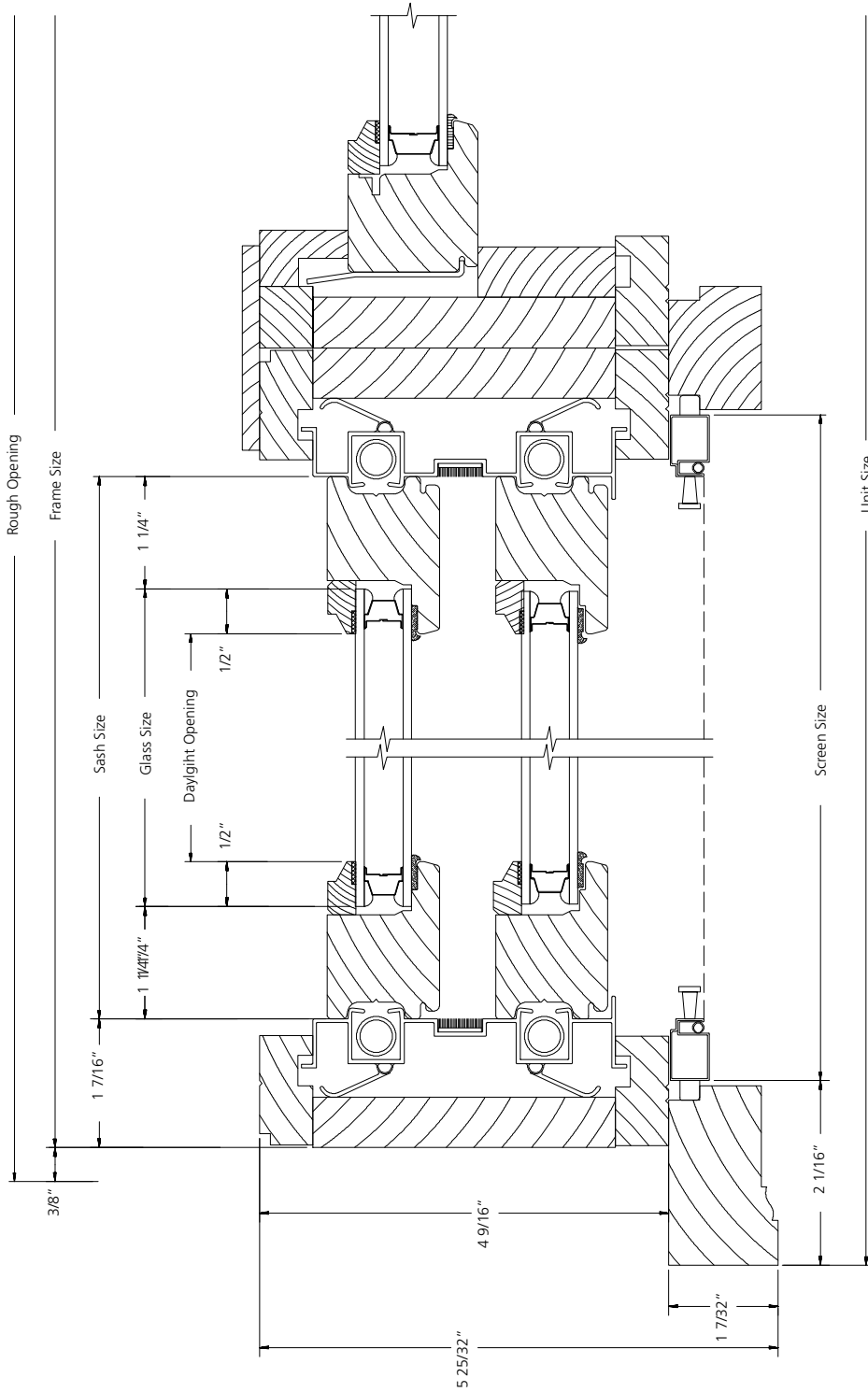

HORIZONTAL SECTION

SCALE: 6" = 1'

TRANSOM UNIT

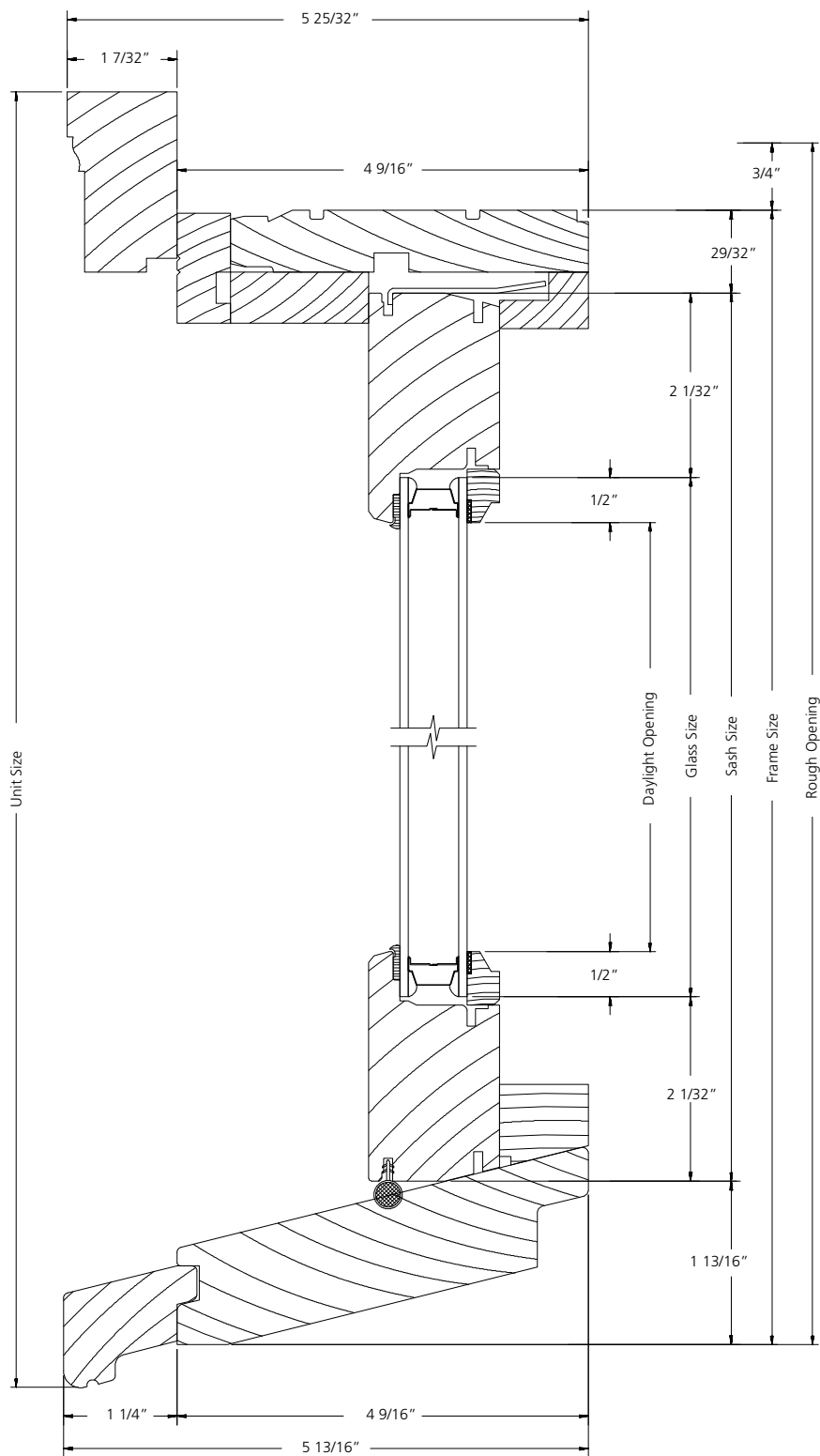

VERTICAL SECTION

SCALE: 6" = 1'

TRANSOM UNIT

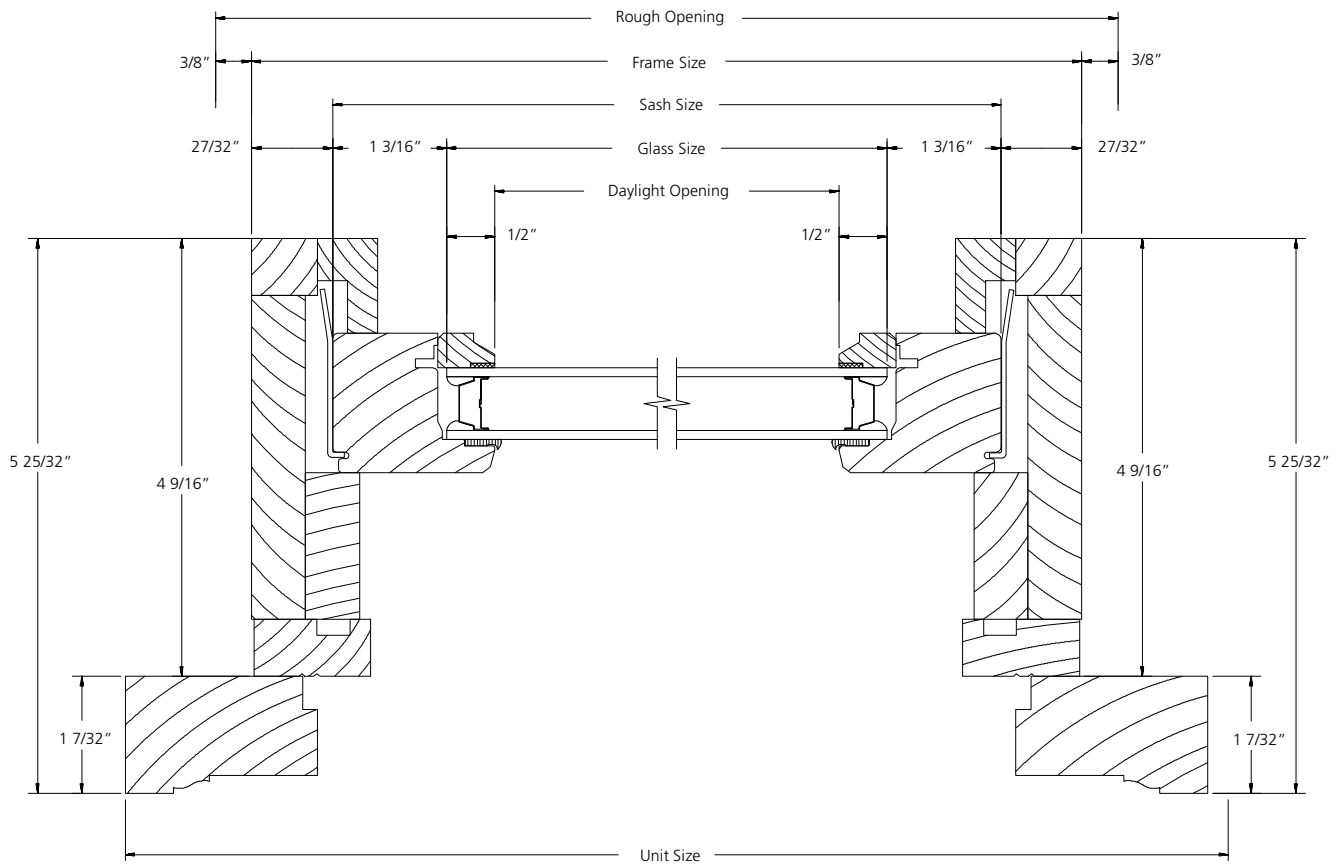

HORIZONTAL SECTION

SCALE: 6" = 1'

POCKET DOUBLE-HUNG UNIT

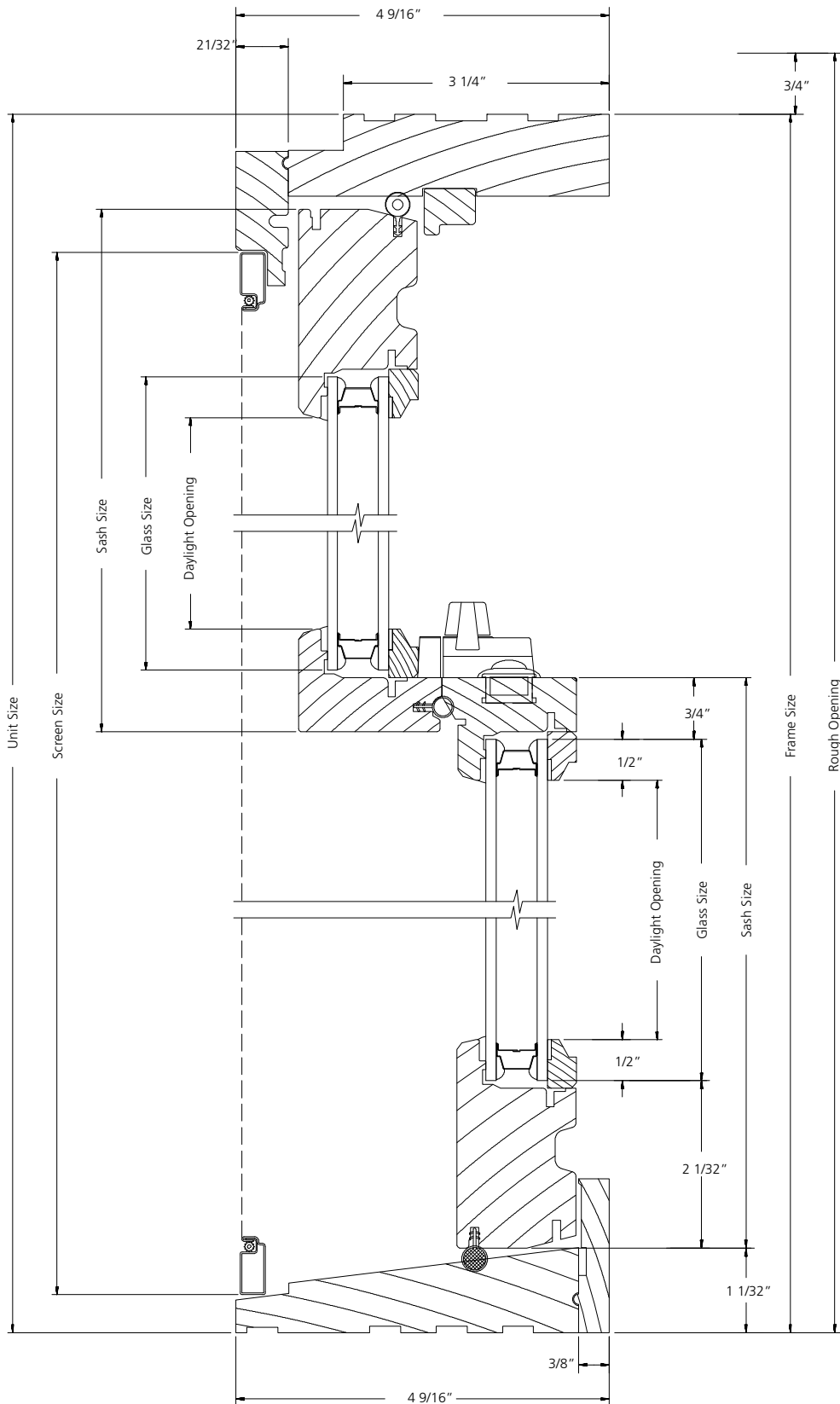

VERTICAL SECTION

SCALE: 6" = 1'

POCKET DOUBLE-HUNG UNIT
DP50 SILL

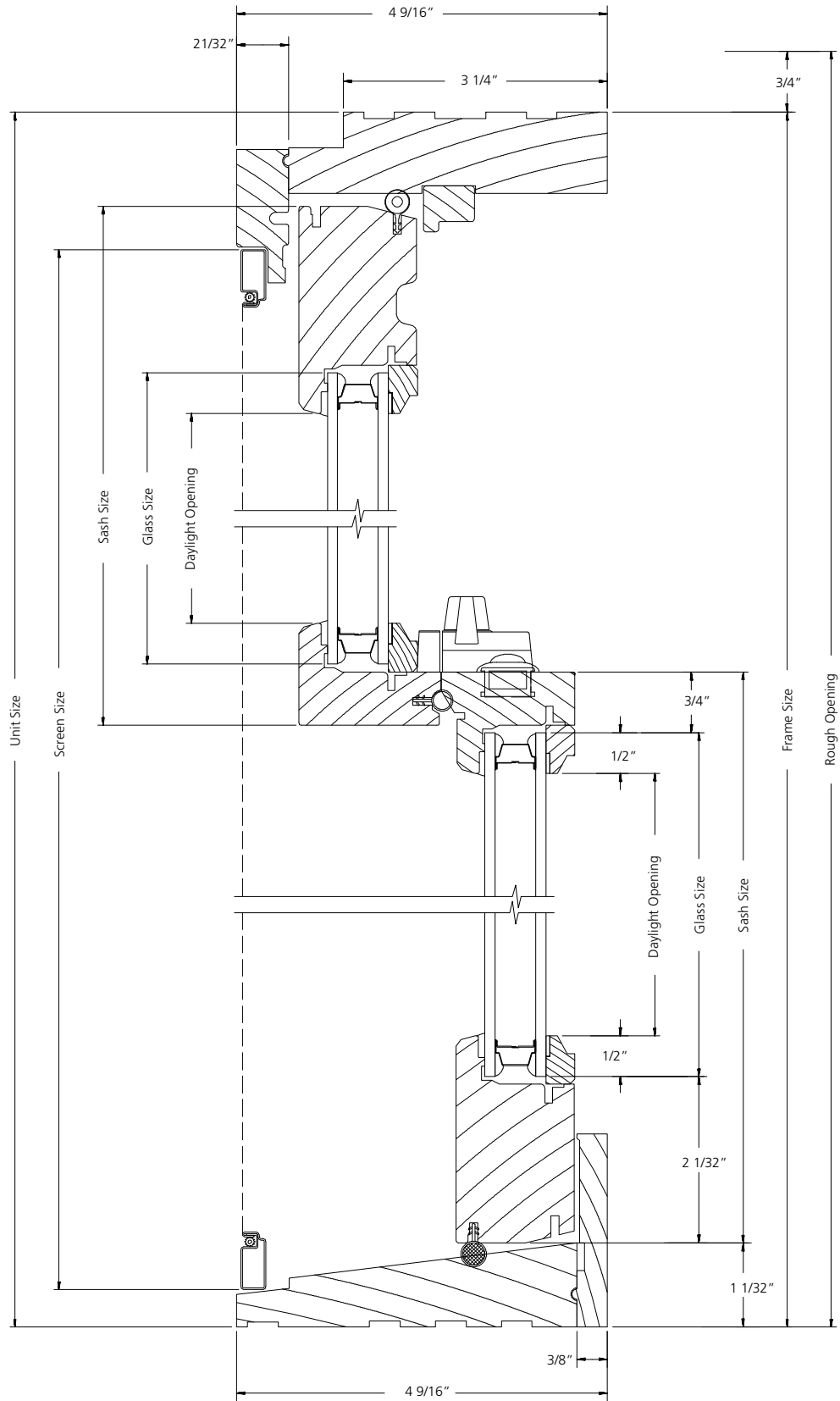

VERTICAL SECTION

SCALE: 6" = 1'

**POCKET DOUBLE-HUNG UNIT
TALL BOTTOM RAIL**

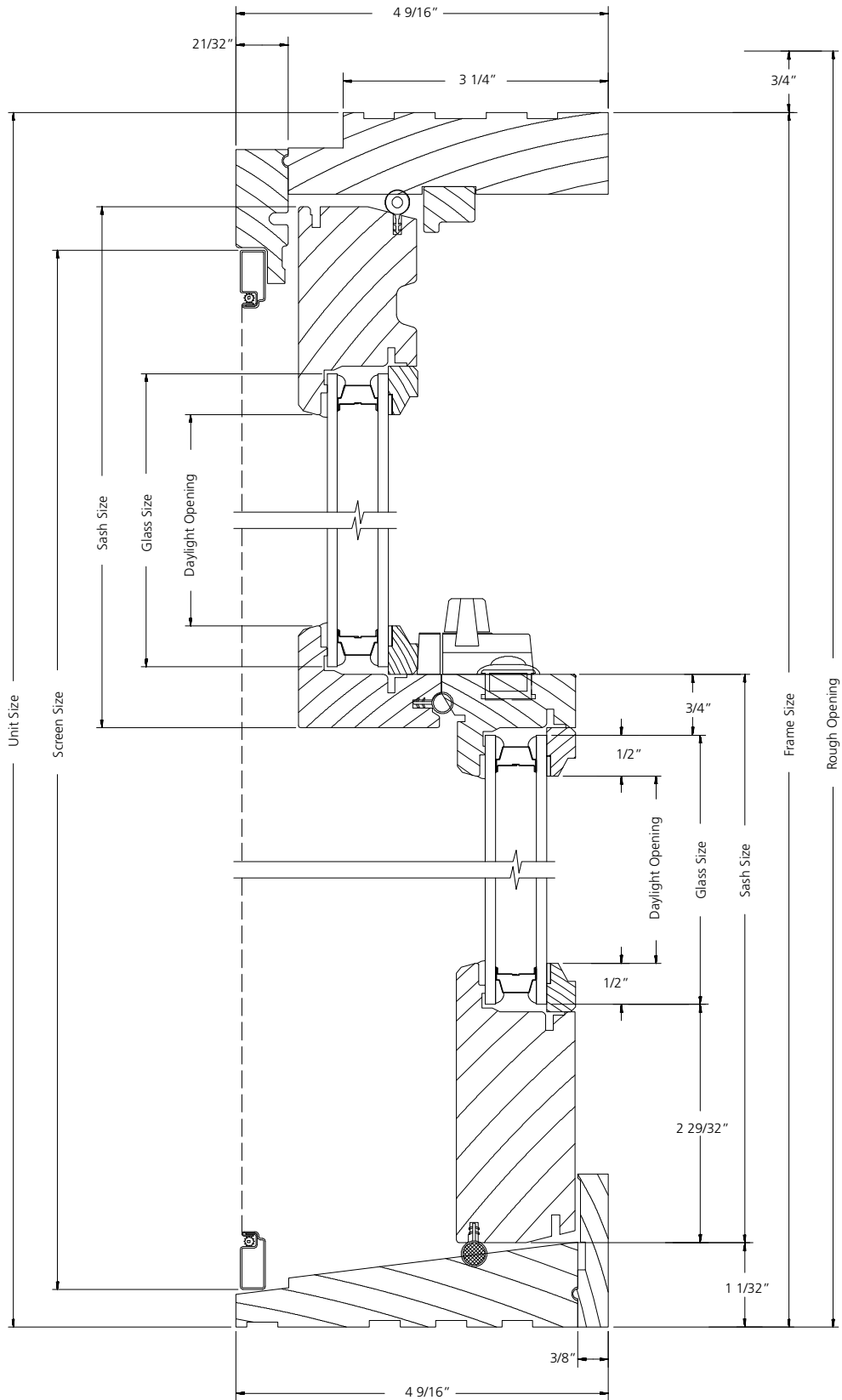

VERTICAL SECTION

SCALE: 6" = 1'

POCKET DOUBLE-HUNG UNIT

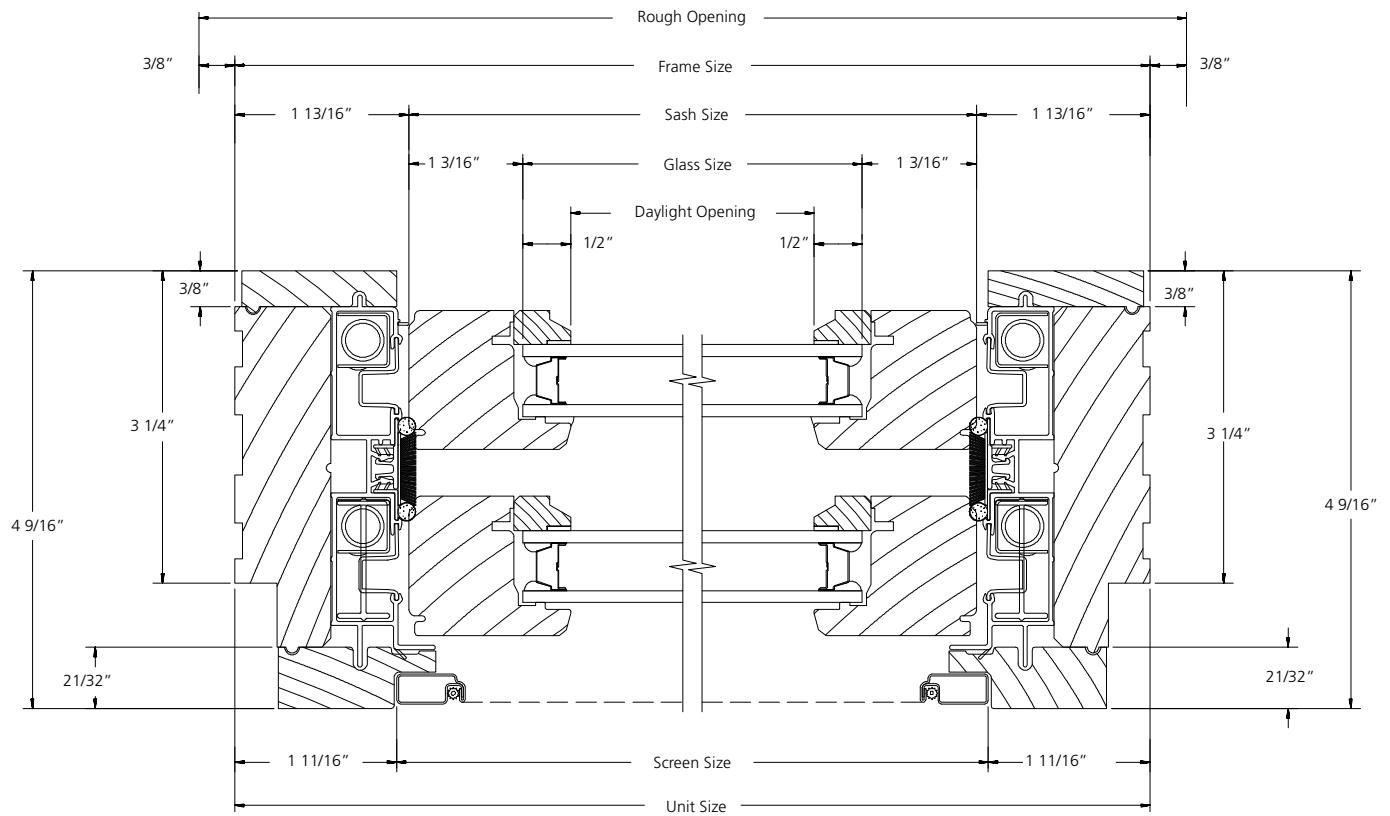

HORIZONTAL SECTION

SCALE: 6" = 1'

POCKET PICTURE UNIT

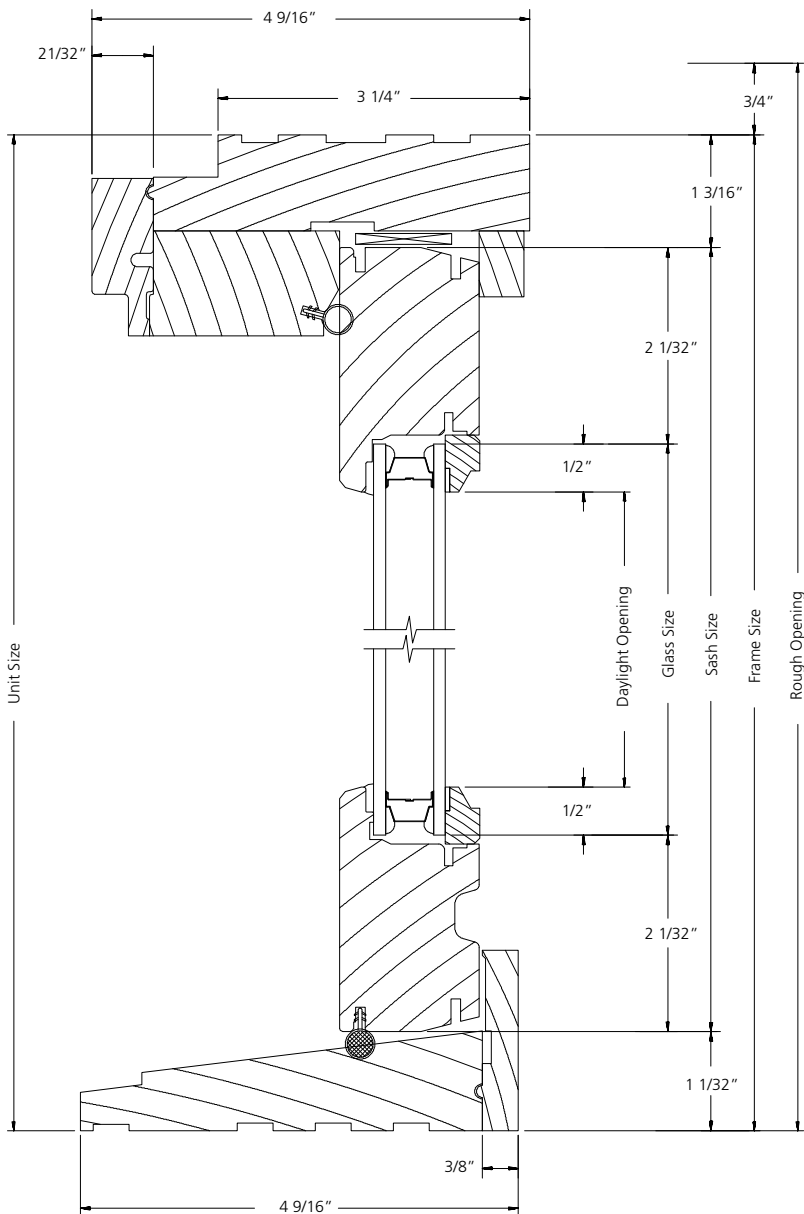

VERTICAL SECTION

SCALE: 6" = 1'

POCKET PICTURE UNIT

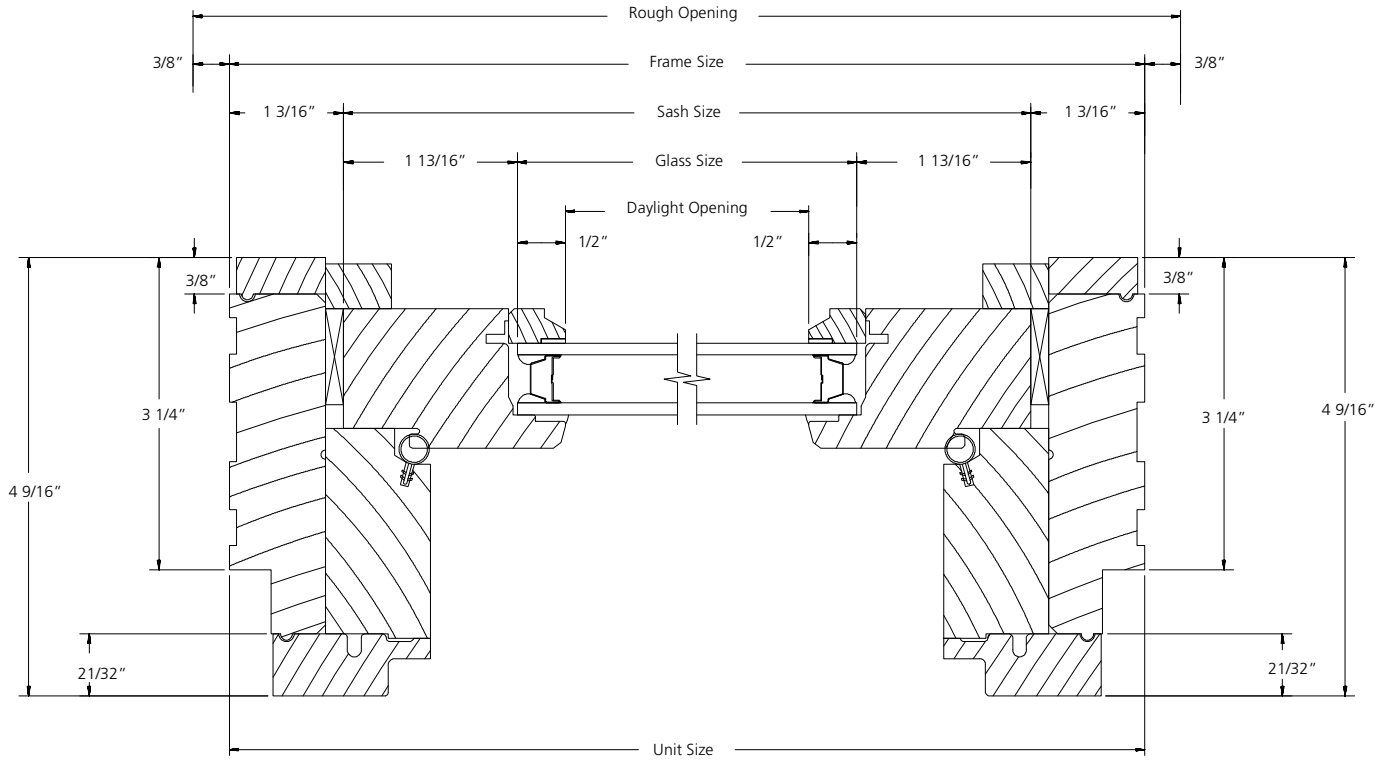

HORIZONTAL SECTION

SCALE: 6" = 1'

BAY WINDOW ROUGH OPENINGS

BAY WINDOW TRIM OPTIONS

The standard offerings for wood double hung bay windows is 'frame only' and brickmould and sillnose. Other trim options subject to approval.

VERTICAL ROUGH OPENING

Rough Opening typical for all Units

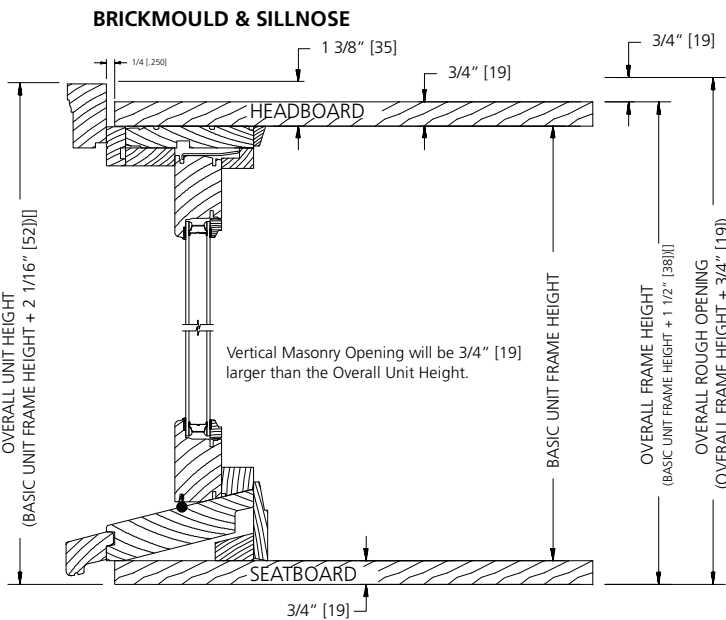
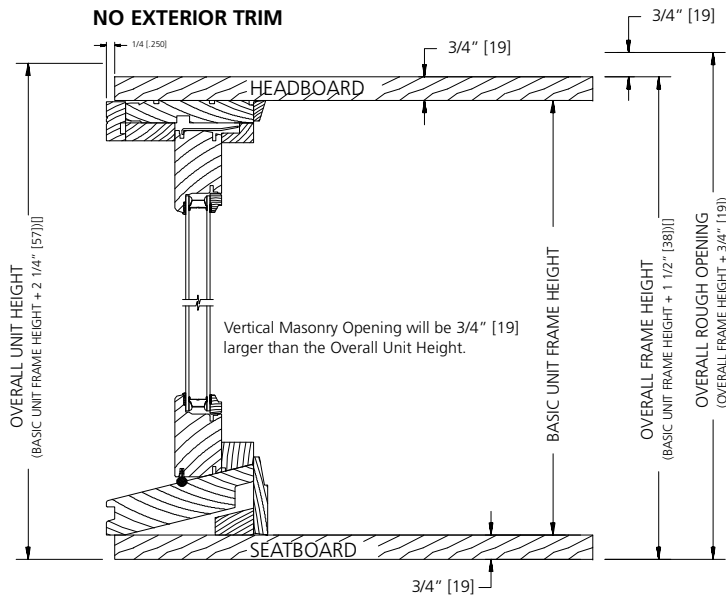

HORIZONTAL ROUGH OPENING

Rough Opening typical for all Units

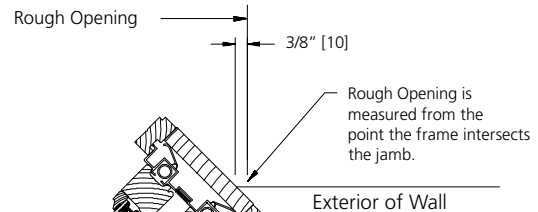

30° & 45° BAYS
45° Bay shown without trim

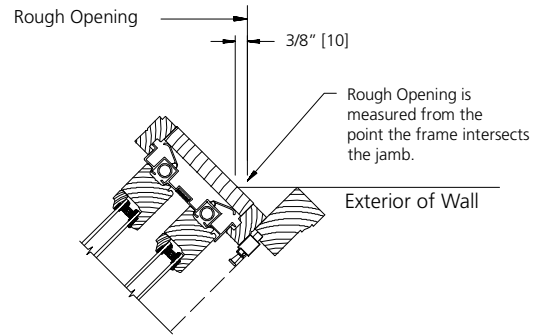

30° & 45° BAYS
30° Bay shown with Brickmould

SCALE: 3" = 1'

30° ANGLE BAY UNIT

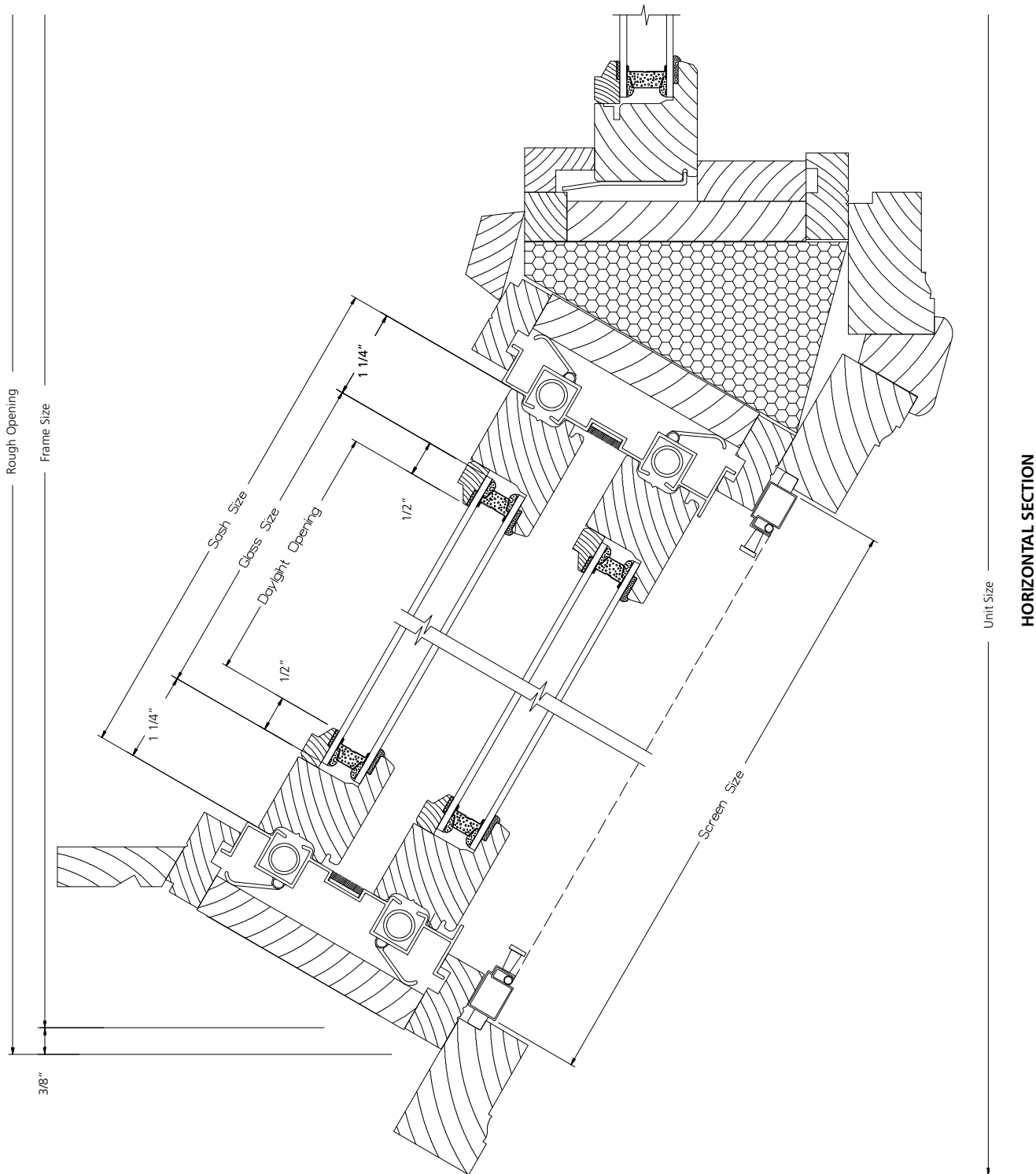

SCALE: 6" = 1'

45° ANGLE BAY UNIT

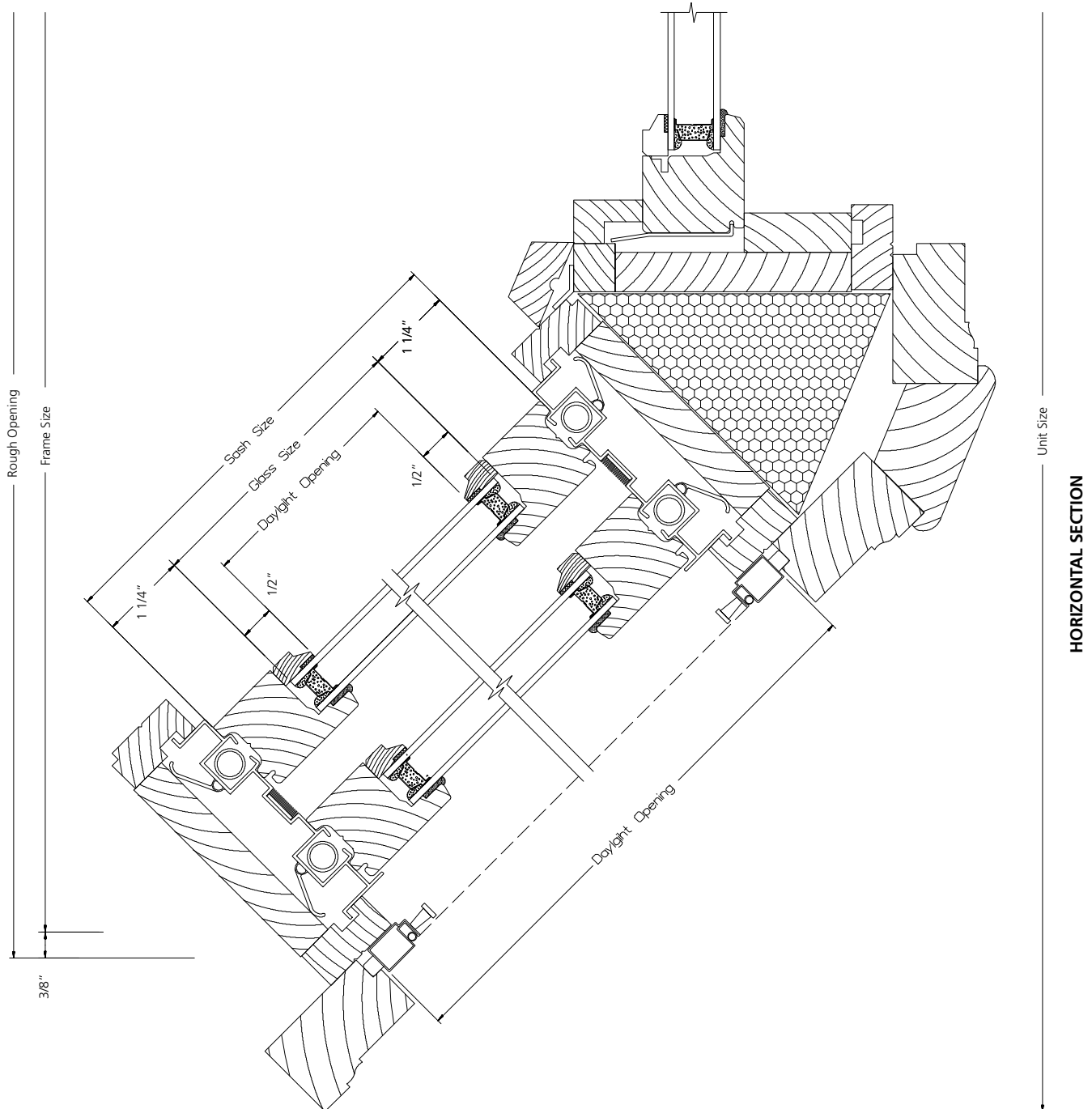

HORIZONTAL SECTION

SCALE: 6" = 1'